

# OS2 75 AS L

CATALOGO

TECNICO

TECHNICAL

CATALOGUE

**METALFORM**

versione 03/2023

The logo for Secco, featuring the word "secco" in white lowercase letters on a red trapezoidal background that tapers to the right.

**secco**





<b>1</b>	<b>Informazioni generali / General informations</b>	
	Descrizione del sistema / System description .....	1.1.1
	Tipologie e limiti dimensionali / Typologies and dimensional limits .....	1.2.1 – 1.2.13
<b>2</b>	<b>Componenti del sistema / System component</b>	
	Profili / Profiles .....	2.1.1 – 2.1.13
	Accessori / Accessories .....	2.2.1 – 2.2.2
	Ferramenta / Hardware .....	2.3.1 – 2.3.8
	Squadrette / Brackets .....	2.4.1 - 2.4.3
	Maniglie / Handles .....	2.5.1
	Guarnizioni / Gaskets .....	2.6.1 – 2.6.2
	Attrezzature / Working tools .....	2.7.1
	Prodotti / Products .....	2.8.1 – 2.8.2
	Fermavetri / Glazing beads .....	2.9.1 – 2.9.12
<b>3</b>	<b>Tecnica del sistema / System technique</b>	
	Sezioni / Sections .....	3.1.1 – 3.1.40
	Attacchi a muro / Attachment to structure .....	3.2.1 – 3.2.11
<b>4</b>	<b>Lavorazioni e ciclo produttivo / Processing plan</b>	
	Distinte di taglio - Lista componenti / Cutting list - Component list .....	4.1.1 – 4.1.33
	Telaio - Lavorazione e applicazione accessori/ Frame - Working and installation accessories .....	4.2.1 – 4.2.78
	Anta - Lavorazione e applicazione accessori/ Sash - Production cycle and processing .....	4.3.1 – 4.3.91
	Motorizzato / Automated .....	MC.1 – MC.14
<b>5</b>	<b>Note generali sul processo / Processing general informations</b>	
	Raccomandazioni per la lavorazione / Working recommendations .....	5.1.1 – 5.1.5
	Taglio, asolature, forature / Cutting, slots, holes .....	5.2.1 – 5.2.2
	Senso di apertura / Side opening .....	5.3.1 – 5.3.5
	Controllo qualità / Quality control activities .....	5.4.1 – 5.4.2
	Materiali e finiture / Material and finishing .....	5.5.1 – 5.5.2
	Indice analitico / Subject index .....	5.6.1



**OS2 75 AS L** è un sistema integrato di accessori, guarnizioni e profilati a **taglio termico** aventi profondità di 84 mm e sezione in vista di 62 mm. Il sistema consente di realizzare serramenti alzanti scorrevoli da una a sei ante, apribili e/o fisse. Il peso massimo delle singole ante è di 250 kg e il sistema installa vetri a doppia camera da 35/51 mm di spessore.

Le prestazioni di tenuta al passaggio di aria e acqua e di isolamento acustico sono ottenute grazie alla compressione dei giunti di tenuta durante la chiusura delle ante. Tali giunti sono progettati con doppia guarnizione di tenuta sui quattro lati, un dedicato profilo soglia per il drenaggio dell'acqua e speciali tamponi in gomma e neoprene posizionati alle estremità verticali del giunto centrale.

Ogni tipologia è provvista di apposita accessoristica di movimentazione e chiusura a scomparsa ed integrata al sistema con chiusure multiple: tutte le soluzioni possono essere motorizzate tramite l'installazione dei gruppi motore, dedicati e a scomparsa, che ne consentono l'alzata e lo scorrimento.

Le prestazioni del sistema a taglio termico **OS2 75 AS L** sono state testate, nelle configurazioni più estreme di peso e dimensione, dai migliori Laboratori di certificazione Europei secondo le norme di riferimento EN 14351-1.

**OS2 75 AS L** is an integrated system of accessories, gaskets and **thermally broken** cold-rolled profiles with a nominal depth of 84 mm and visible section of 62 mm. The system allows the manufacture of lift-and-slide doors with up to six sashes openable and/or fixed. The maximum weight per sash is 250 kg, and the system can be fitted with a TGU of 35/51 mm thick.

High performance of the system in terms of air permeability, watertightness and sound reduction is achieved thanks to the compression provided by the sealing joints in closing position. These joints are designed with double sealing gaskets along all four sides, a dedicated threshold profile for water drainage and special rubber and neoprene pads positioned at the top of the central joint.

Each typology comes with a dedicated set of accessories for concealed handling and multi-locking system: all configurations can be automated by means of dedicated and concealed motor units, which allow the lifting and sliding of the system.

The performances of the thermally broken system **OS2 75 AS L** have been tested in the most extreme configurations of weight and size from the best European certification laboratories according to the reference standards EN 14351-1.

#### PRESTAZIONI

Trasmittanza termica (UNI EN 14351/1)

- Uw fino a 1,4 W/m<sup>2</sup>K

Resistenza all'aria (UNI EN 12207)

- fino a classe 4

Resistenza all'acqua (UNI EN 12208)

- fino a classe 9A

Resistenza al vento (UNI EN 12210)

- fino a classe B3

Forze di azionamento (UNI EN 12046/1)

- Classe 1 < 100 N

#### PERFORMANCE

Thermal transmittance (UNI EN 14351/1)

- Uw up to 1,4 W/m<sup>2</sup>K

Air permeability (UNI EN 12207)

- up to class 4

Watertightness (UNI EN 12208)

- up to class 9A

Resistance to wind load (UNI EN 12210)

- up to class B3

Operating forces (UNI EN 12046/1)

- Class 1 < 100 N



Schema | Type A

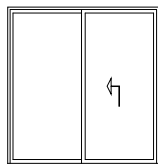

Schema | Type B

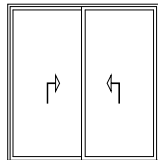

Schema | Type C

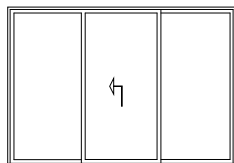

Schema | Type E

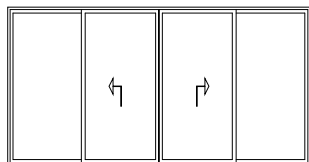

Schema | Type F

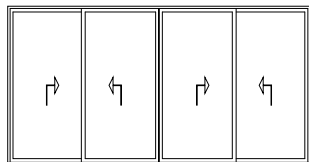

Schema | Type S1

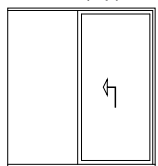

Schema | Type S2

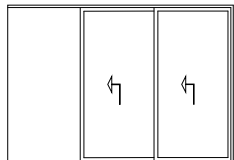

Schema | Type S3

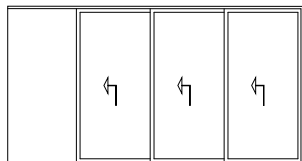

Schema | Type A3

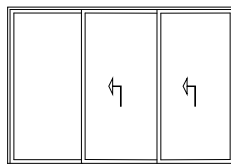

Schema | Type B3

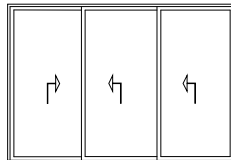

Schema | Type C3

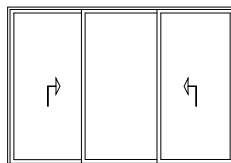

Schema | Type E3

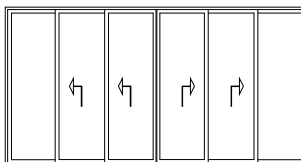

Schema | Type F3

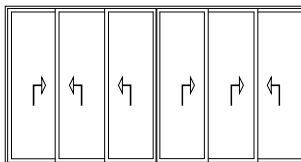

Schema | Type T1

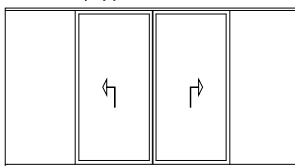

Schema | Type T2

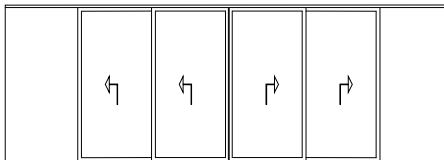

Schema | Type T3

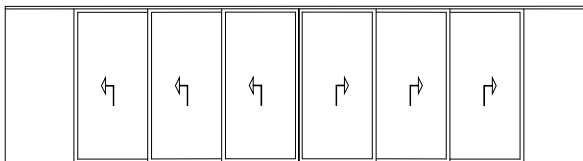

Schema | Type A 1 anta scorrevole ed 1 anta fissa  
1 sliding and 1 fixed sash

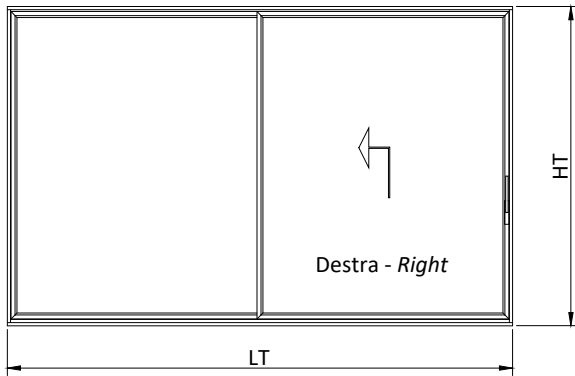

Schema | Type B 2 ante scorrevoli  
2 sliding sashes

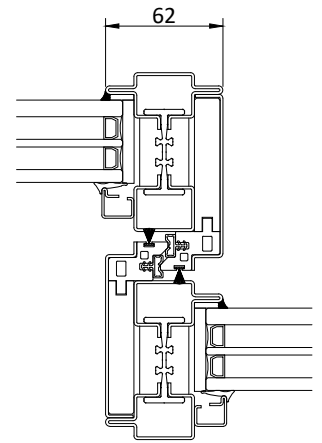
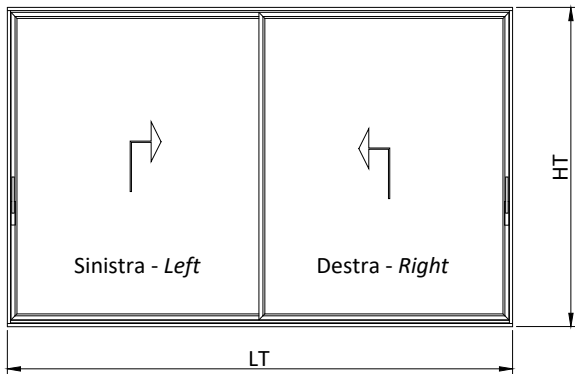

Limiti dimensionali | Dimensional limits (mm)

Telaio Frame	LT	1396 - 3116	LT
	HT	1227 - 3000	HT
Anta Sash	LA	700 - 1560	LT/2 + 2
	HA	1135 - 2908	HT - 92
Peso Weight		250 kg	

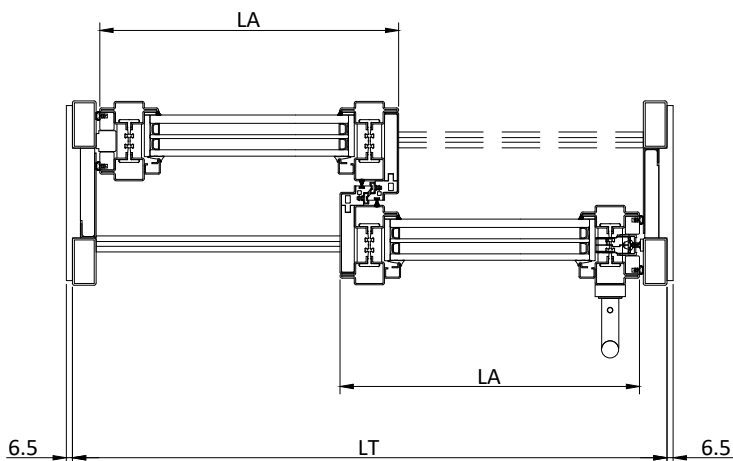
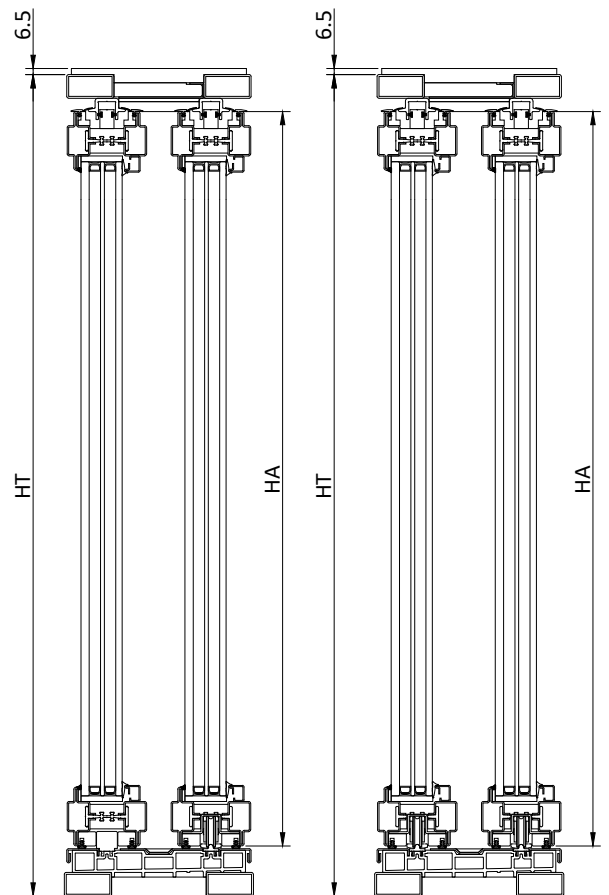

Schema | Type C serie di ante fisse e ante scorrevoli  
series of fixed and sliding sashes

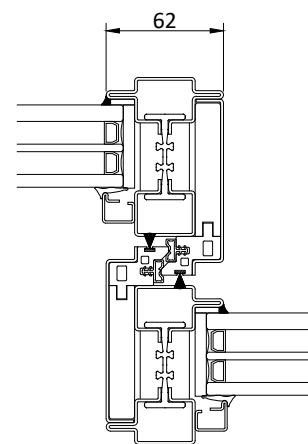
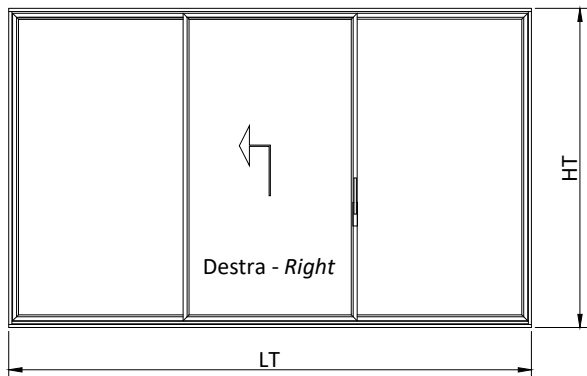

Limiti dimensionali | Dimensional limits (mm)

Telaio Frame	LT	2034 - 4614	LT
	HT	1227 - 3000	HT
Anta Sash	LA	700 - 1560	LT/3 + 22
	HA	1135 - 2908	HT - 92
Peso Weight	250 kg		

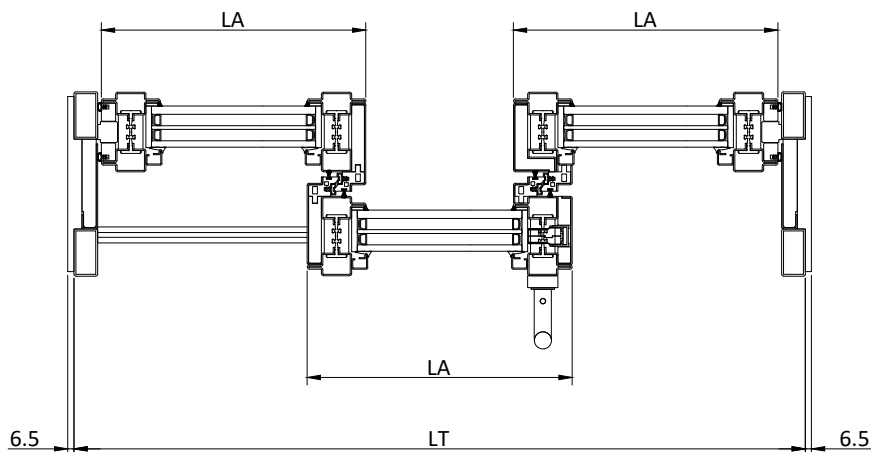
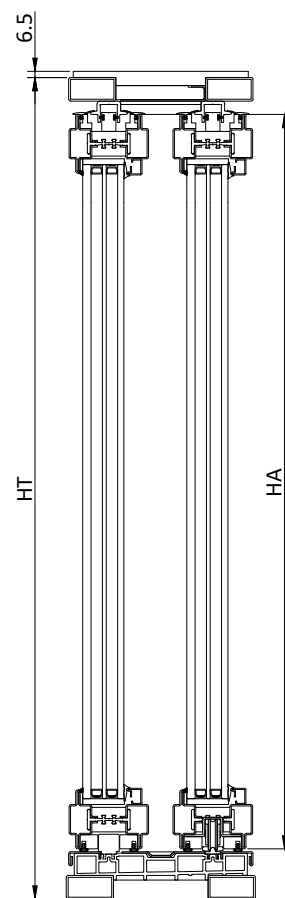

Schema | Type E 2 ante scorrevoli e 2 ante fisse  
2 sliding and 2 fixed sashes

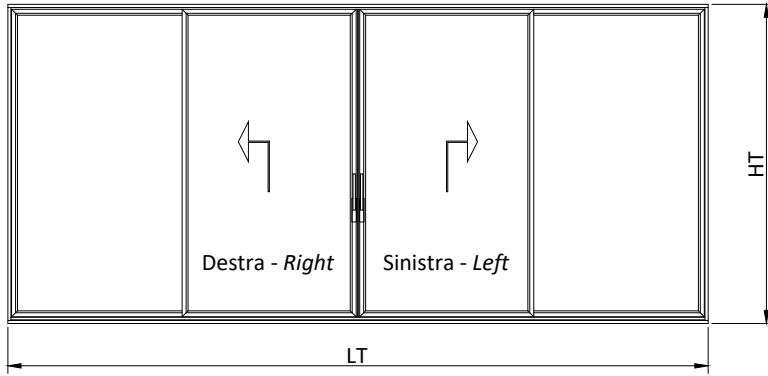

Schema | Type F 4 ante scorrevoli  
4 sliding sashes

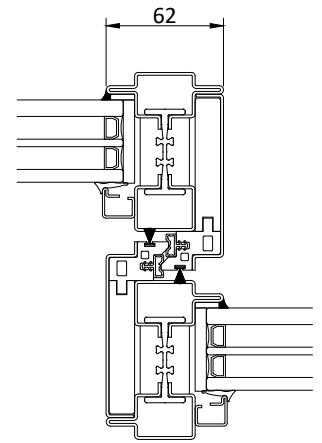
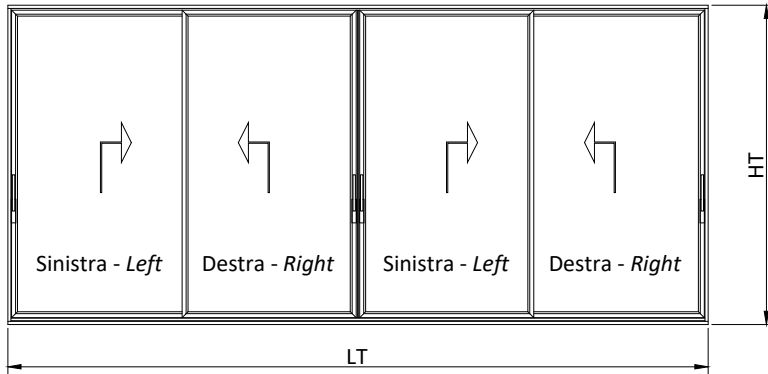

Limiti dimensionali | Dimensional limits (mm)

Telaio Frame	LT	2738 - 6178	LT
	HT	1227 - 3000	HT
Anta Sash	LA	700 - 1560	LT/4 + 15.5
	HA	1135 - 2908	HT - 92
Peso Weight	250 kg		

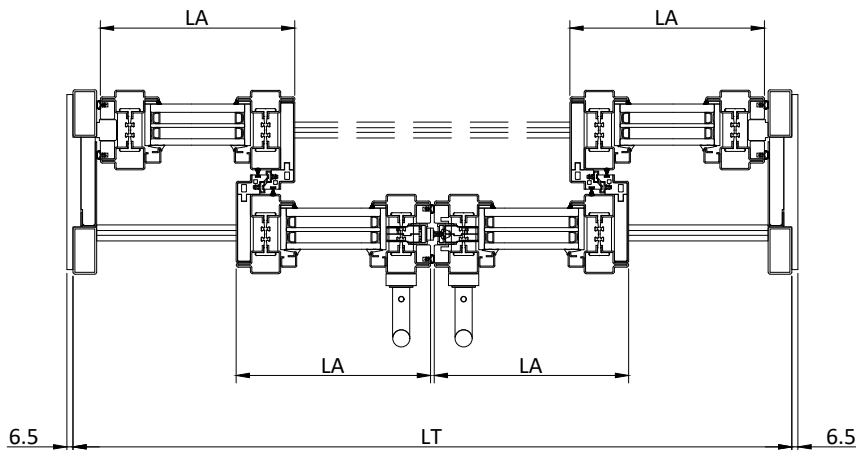
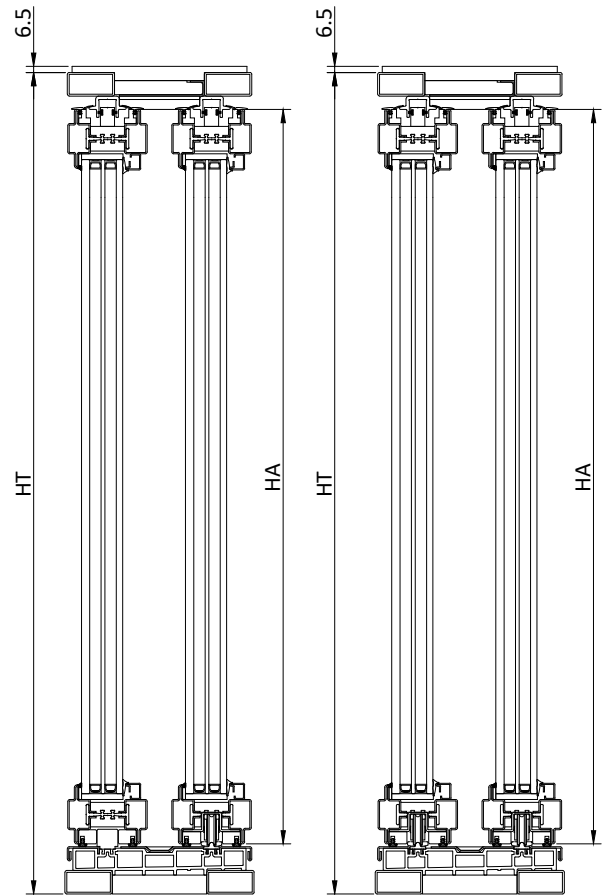



Schema | Type A3 2 ante scorrevoli ed 1 anta fissa  
2 sliding and 1 fixed sash

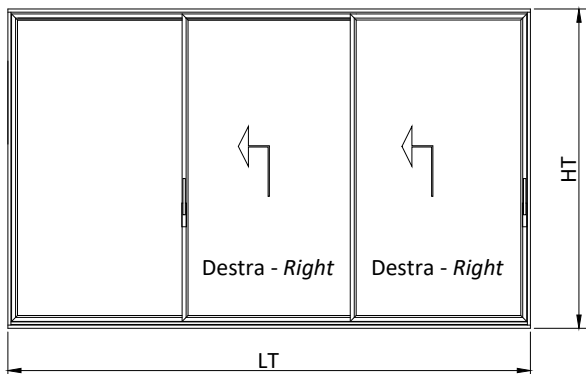

Schema | Type B3 3 ante scorrevoli  
3 sliding sashes

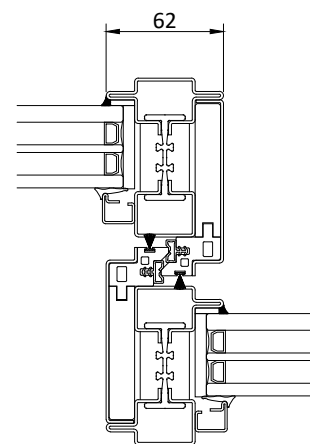
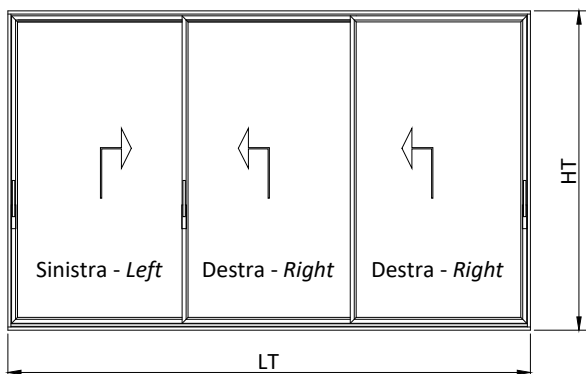

Limiti dimensionali | Dimensional limits (mm)

Telaio Frame	LT	2034 - 4614	LT
	HT	1227 - 3000	HT
Anta Sash	LA	700 - 1560	$LT/3 + 22$
	HA	1135 - 2908	$HT - 92$
Peso Weight	250 kg		

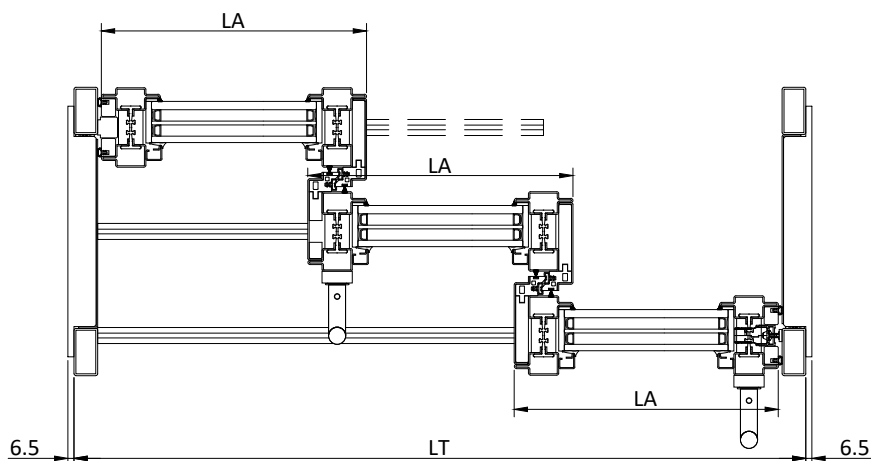
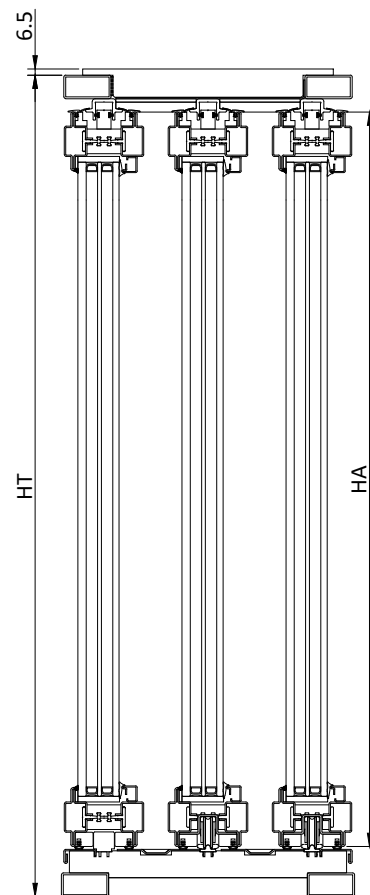

Schema | Type C3 2 ante scorrevoli e 1 anta fissa  
2 sliding and 1 fixed sashes

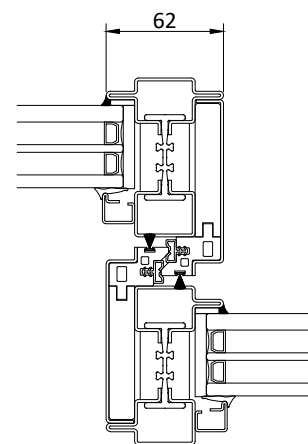
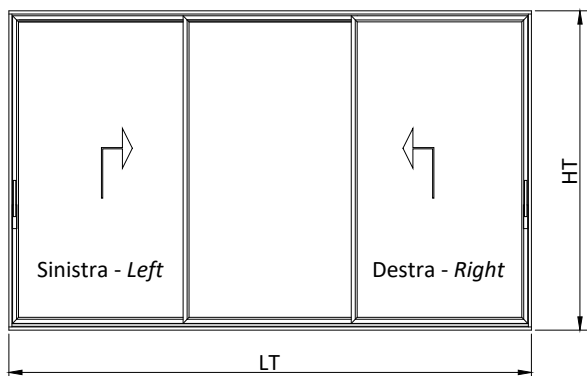

Limiti dimensionali | Dimensional limits (mm)

Telaio Frame	LT	2034 - 4614	LT
	HT	1227 - 3000	HT
Anta Sash	LA	700 - 1560	$LT/3 + 22$
	HA	1135 - 2908	$HT - 92$
Peso Weight	250 kg		

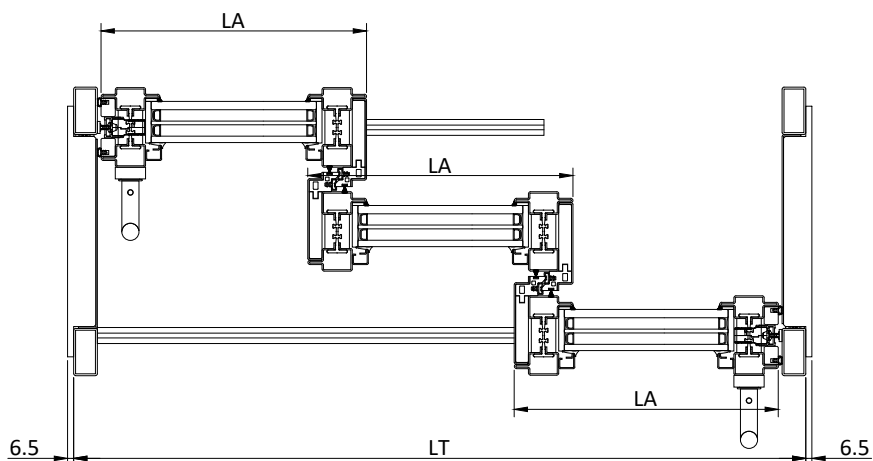
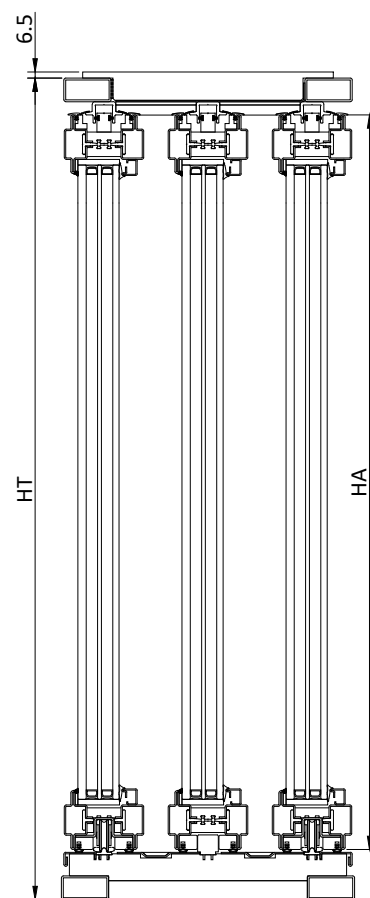

Schema | Type E3 4 ante scorrevoli e 2 ante fisse  
4 sliding and 2 fixed sashes

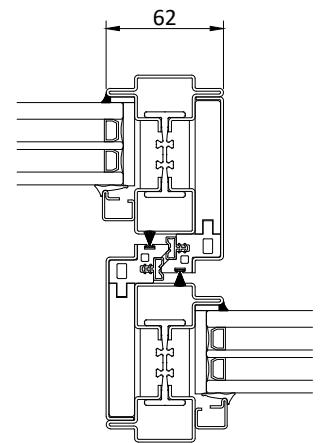
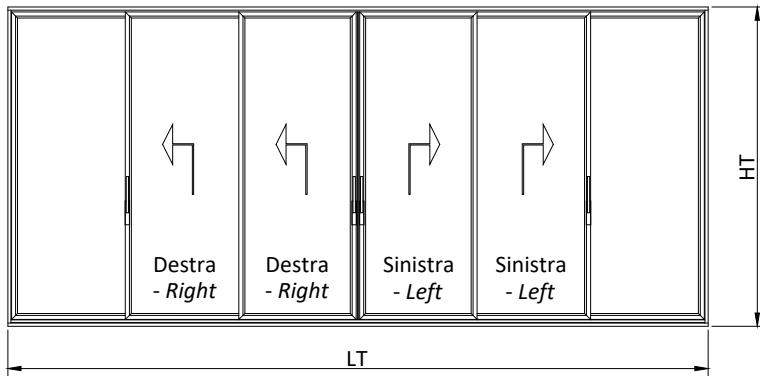

Schema | Type F3 6 ante scorrevoli  
6 sliding sashes

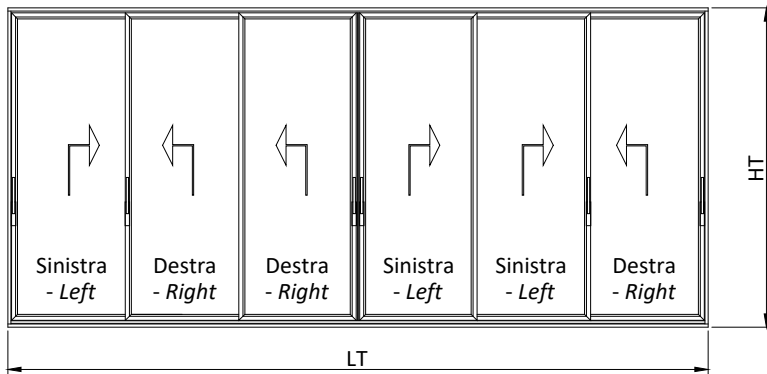

Limiti dimensionali | Dimensional limits (mm)

Telaio Frame	LT	4014 - 9174	LT
	HT	1227 - 3000	HT
Anta Sash	LA	700 - 1560	LT/6 + 31
	HA	1135 - 2908	HT - 92
Peso Weight	250 kg		

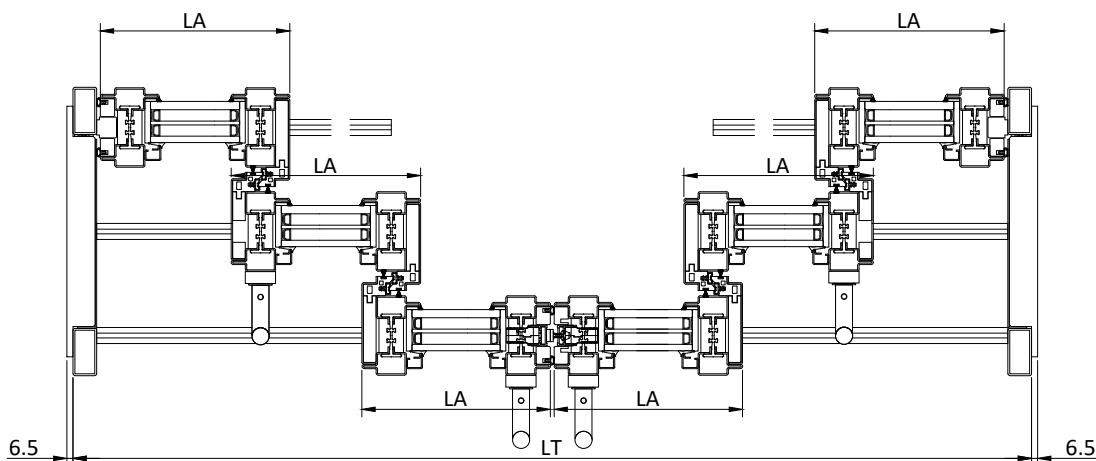
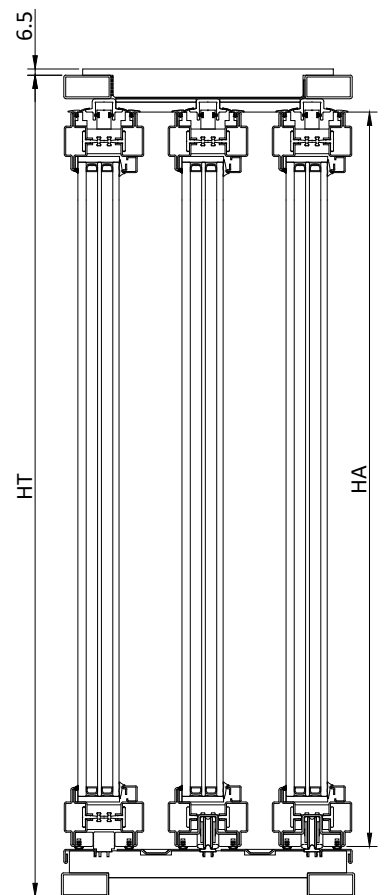

Schema | Type S1 1 anta scorrevole a scomparsa  
1 sliding sash into the wall

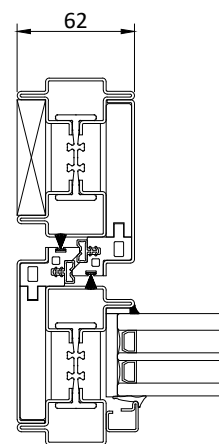
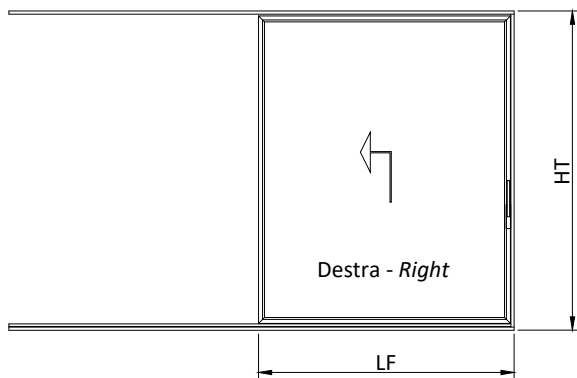

#### Limiti dimensionali | Dimensional limits (mm)

	LF	729 - 1589	LF
Telaio Frame	HT	1227 - 3000	HT
	LT	1424 - 3144	2LF-34
Anta Sash	LA	700 - 1560	LF - 29
	HA	1135 - 2908	HT - 92
Peso Weight		250 kg	

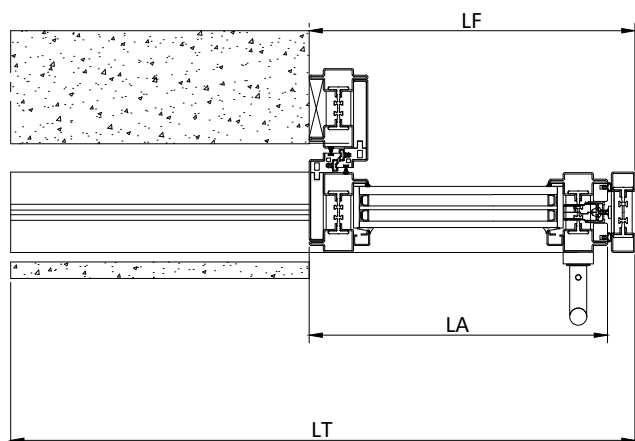
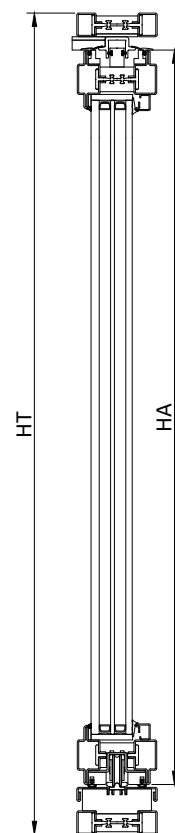

Schema | Type S2 2 ante scorrevoli a scomparsa  
2 sliding sash into the wall

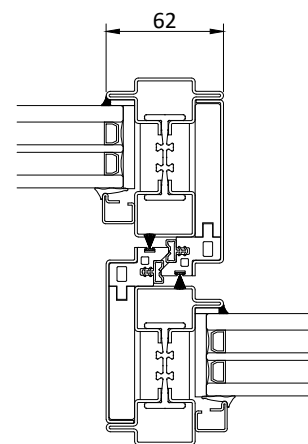
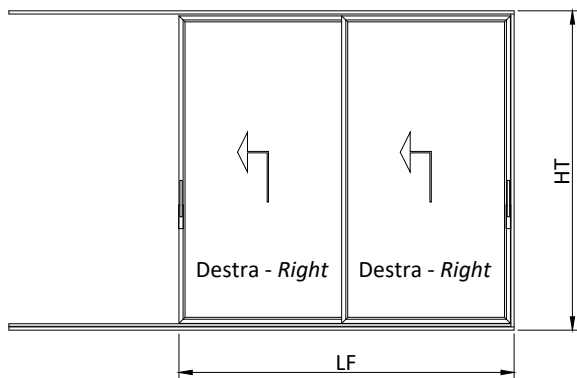

Limiti dimensionali | Dimensional limits (mm)

	LF	1367 - 3087	LF
Telaio Frame	HT	1227 - 3000	HT
	LT	2080 - 4660	$3LF/2 + 29$
Anta Sash	LA	700 - 1560	$LF/2 + 16.5$
	HA	1135 - 2908	$HT - 92$
Peso Weight	250 kg		

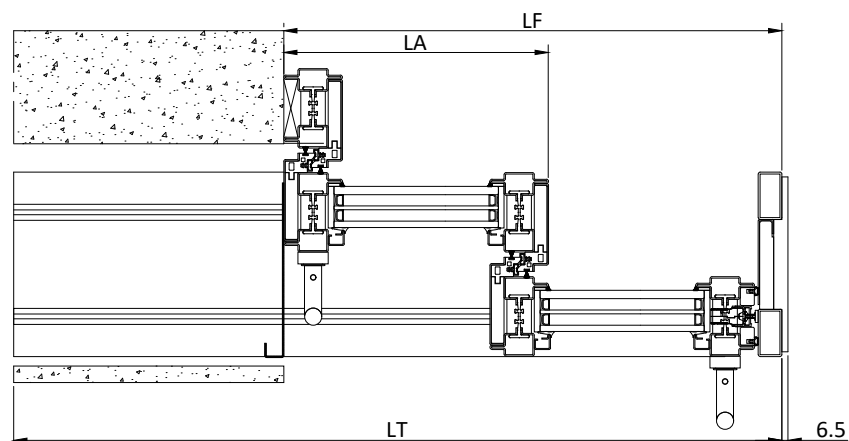
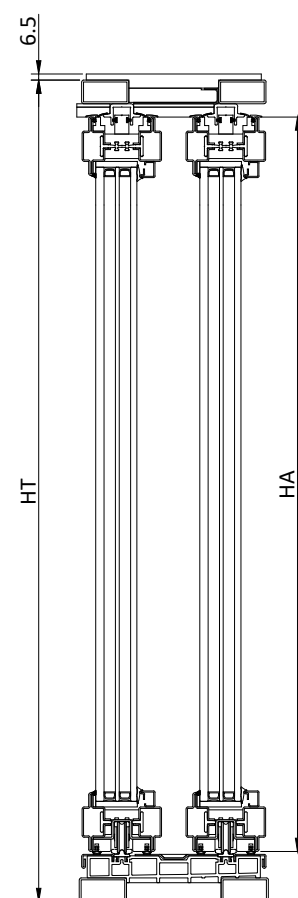

Schema | Type S3 3 ante scorrevoli a scomparsa  
3 sliding sash into the wall

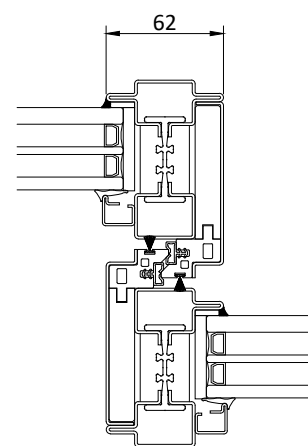
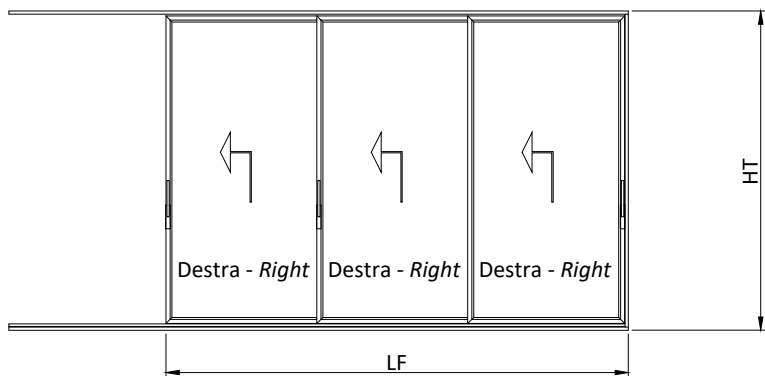

Limiti dimensionali | Dimensional limits (mm)

	LF	2005 - 4585	LF
Telaio Frame	HT	1227 - 3000	HT
	LT	2718 - 6158	4LF/3 + 44
Anta Sash	LA	700 - 1560	LF/3 + 31.5
	HA	1135 - 2908	HT - 92
Peso Weight		250 kg	

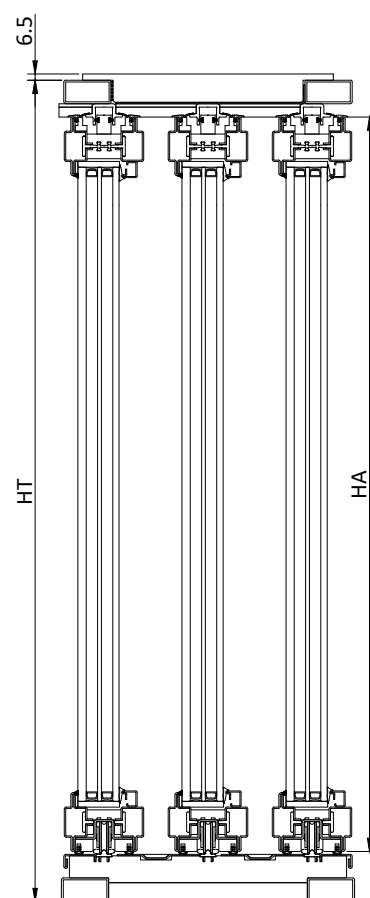
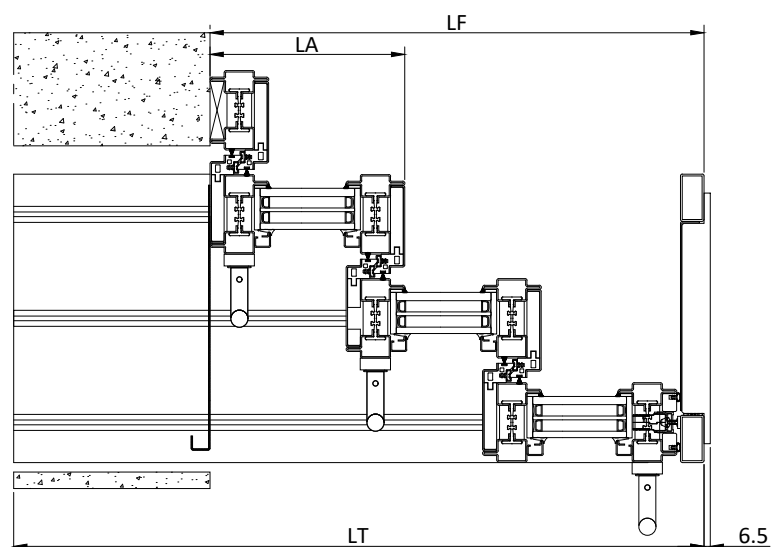

Schema | Type T1 2 ante scorrevoli coassiali a scomparsa  
2 coaxial sliding sashes into the wall

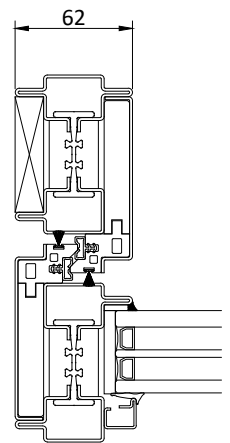
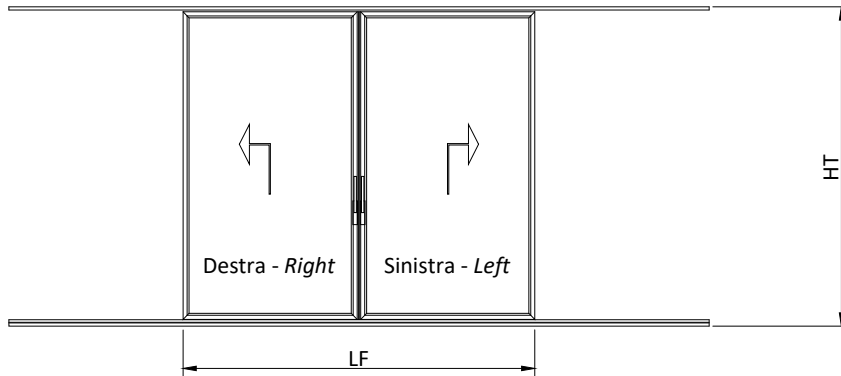

#### Limiti dimensionali | Dimensional limits (mm)

	LF	1404 - 3124	LF
Telaio Frame	HT	1227 - 3000	HT
	LT	2794 - 6234	2LF - 14
Anta Sash	LA	700 - 1560	LF/2 - 2
	HA	1135 - 2908	HT - 92
Peso Weight	250 kg		

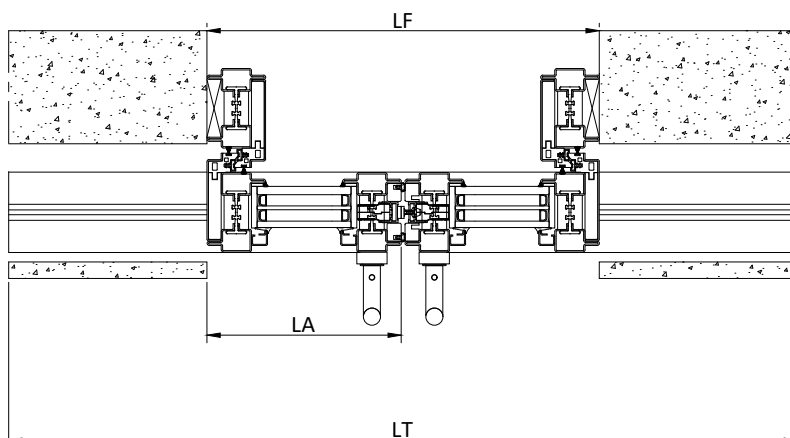
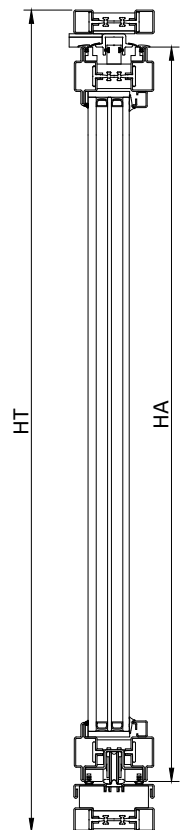

Schema | Type T2 4 ante scorrevoli coassiali a scomparsa  
4 coaxial sliding sashes into the wall

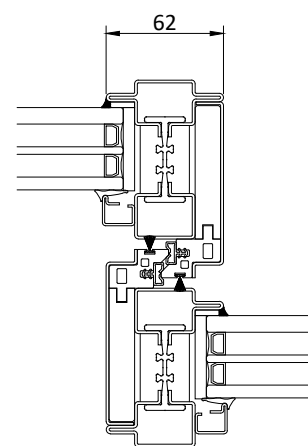
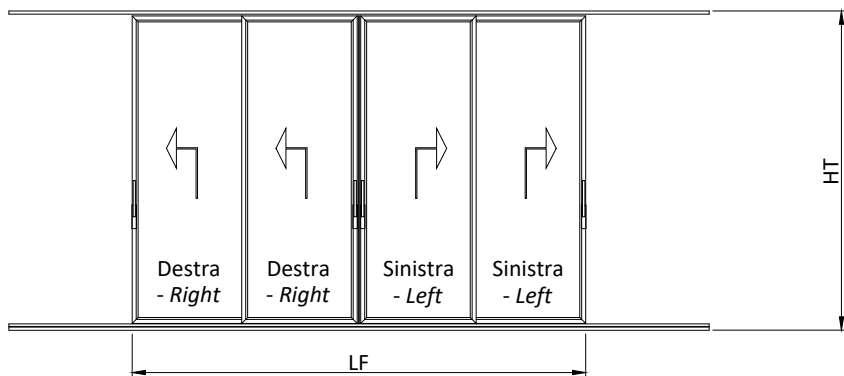

Limiti dimensionali | Dimensional limits (mm)

	LF	2680 - 6120	LF
Telaio Frame	HT	1227 - 3000	HT
	LT	4106 - 9266	3LF/2 + 86
Anta Sash	LA	700 - 1560	LF/4 + 30
	HA	1135 - 2908	HT - 92
Peso Weight		250 kg	

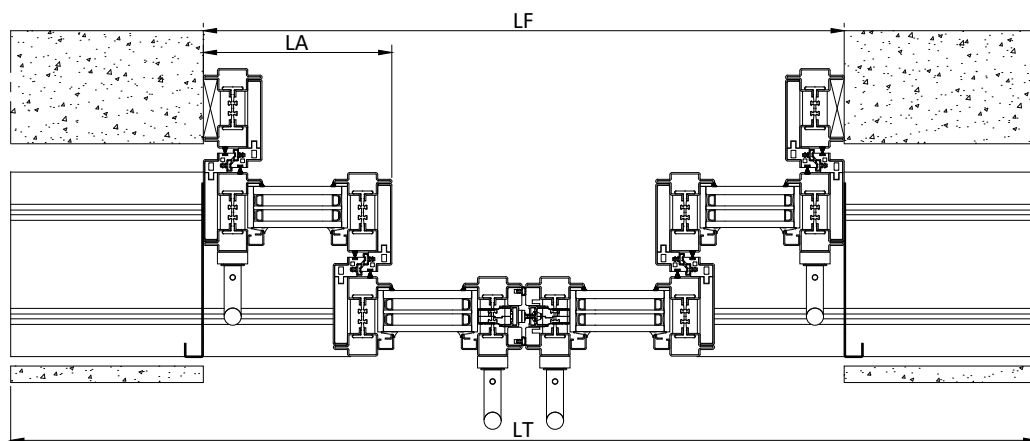
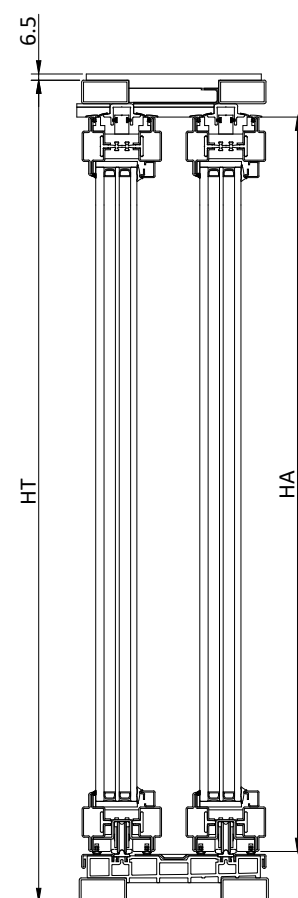



Schema | Type T3 6 ante scorrevoli coassiali a scomparsa  
6 coaxial sliding sashes into the wall

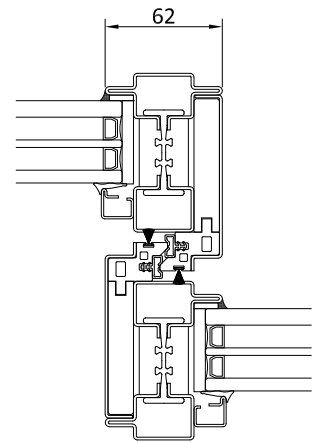
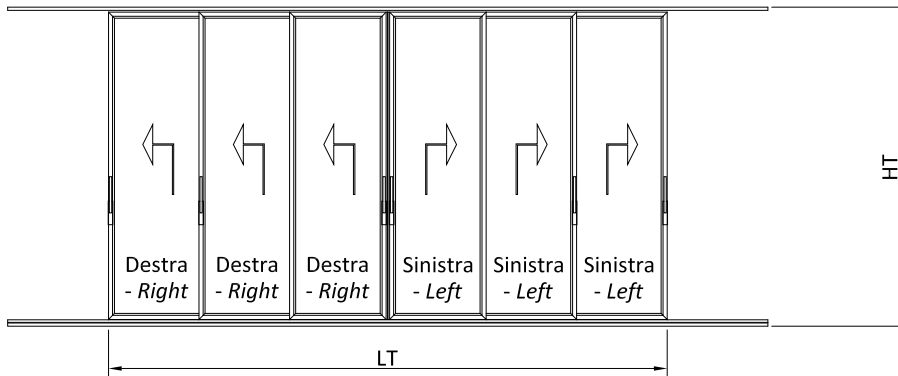

Limiti dimensionali | Dimensional limits (mm)

	LF	3954 - 9114	LF
Telaio Frame	HT	1227 - 3000	HT
	LT	5379 - 12259	4LF/3 + 107
Anta Sash	LA	700 - 1560	LF/6 + 41
	HA	1135 - 2908	HT - 92
Peso Weight	250 kg		

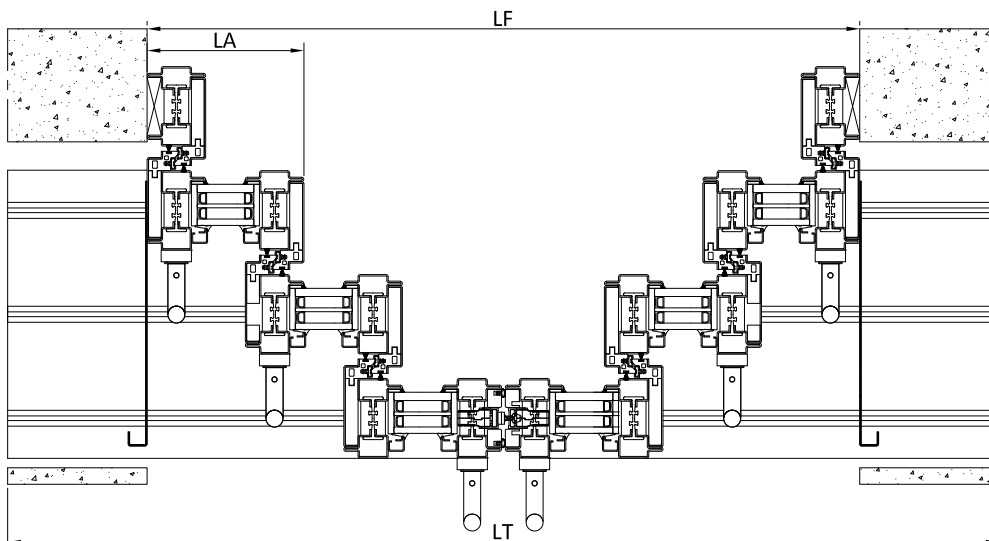
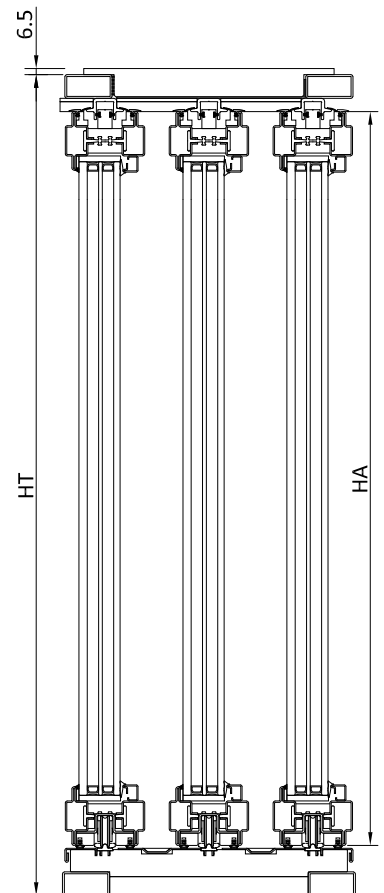

Schema | Type A

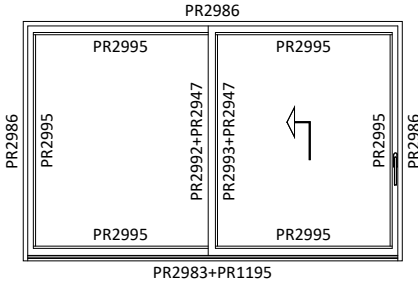

Schema | Type A3

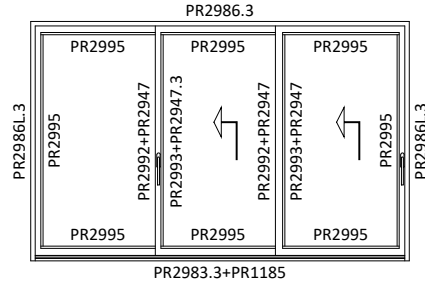

Schema | Type B

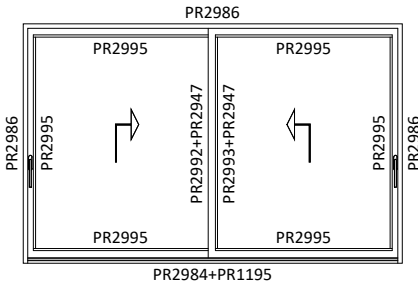

Schema | Type B3

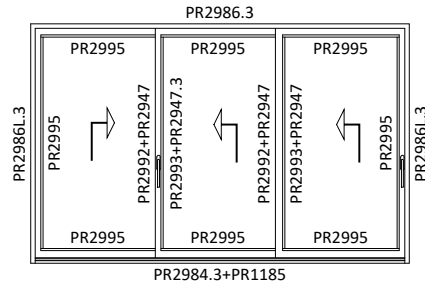

Schema | Type C

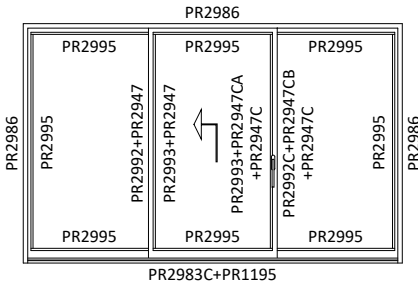

Schema | Type C3

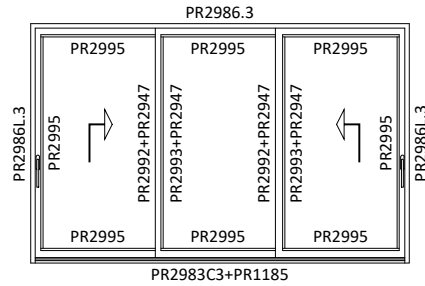

Schema | Type E

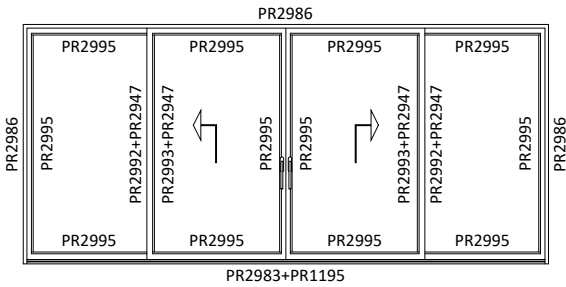

Schema | Type E3

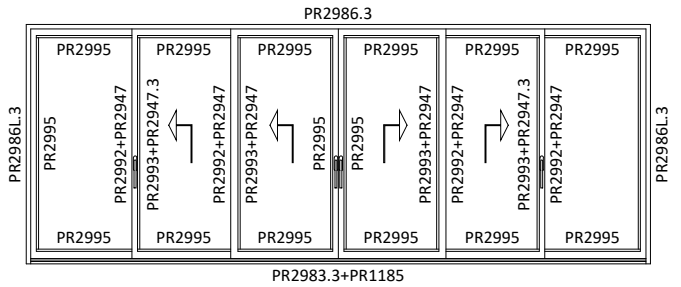

Schema | Type F

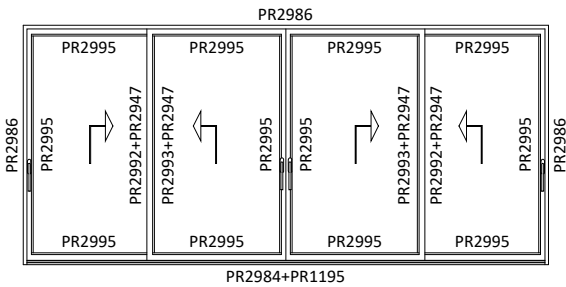

Schema | Type F3

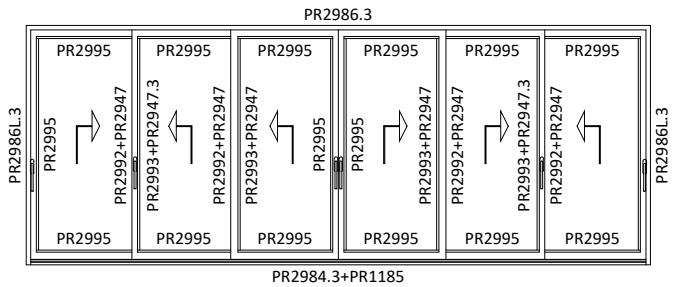

Schema | Type S1

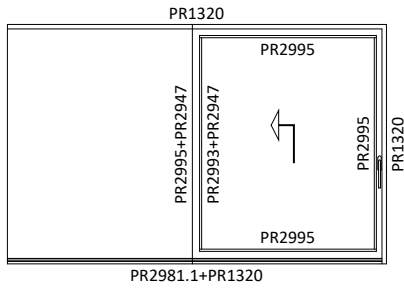

Schema | Type T1

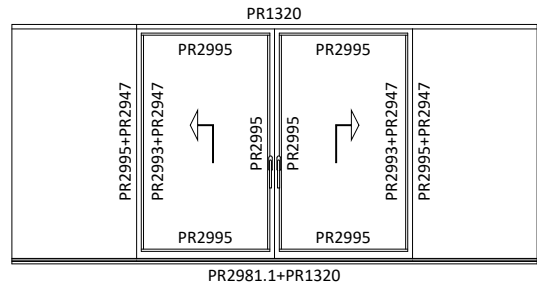

Schema | Type S2

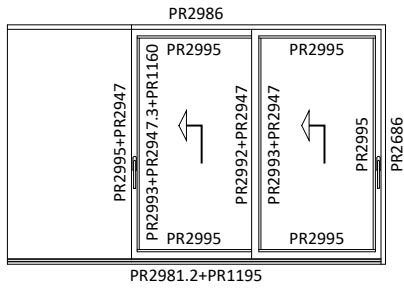

Schema | Type T2

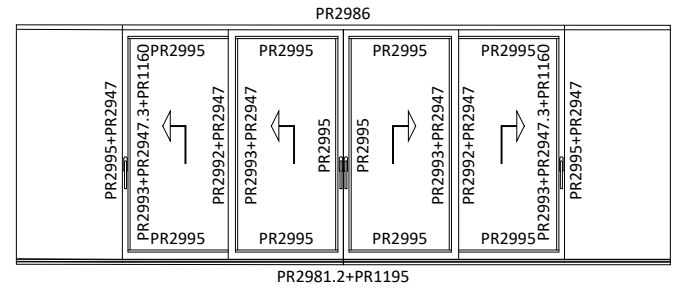

Schema | Type S3

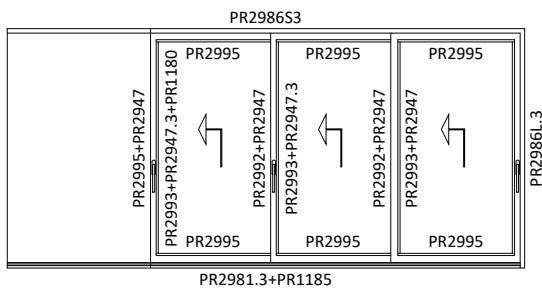

Schema | Type T3

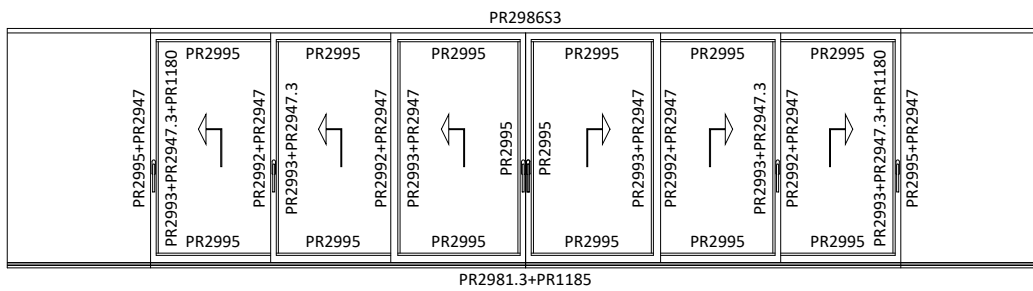

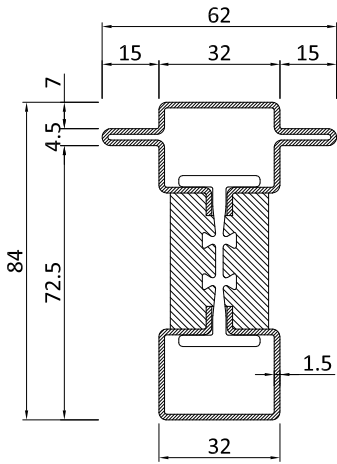

PR2992

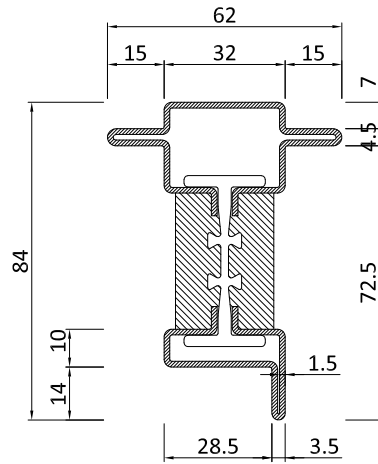

PR2992C

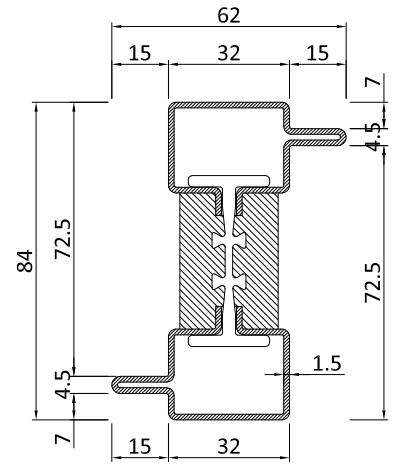

PR2993

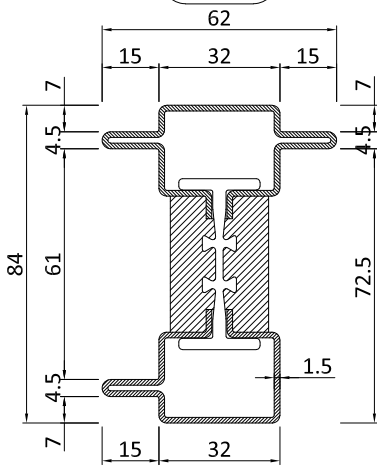

PR2995

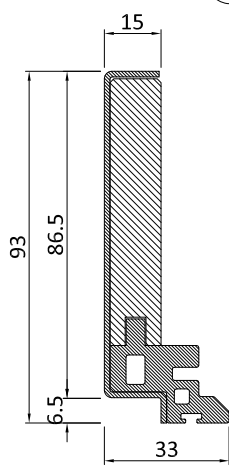

PR2947

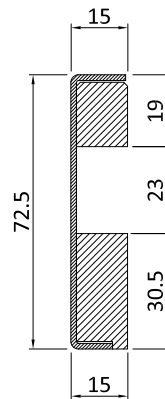

PR2947CA

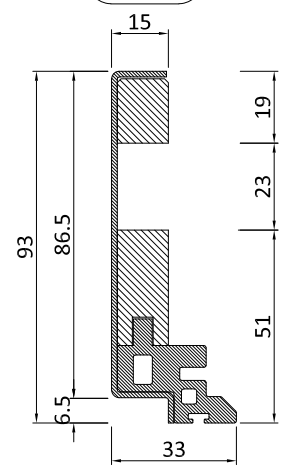

PR2947.3

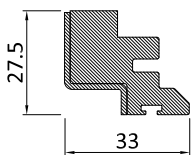

PR2947C

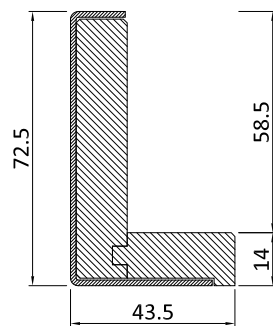

PR2947CB

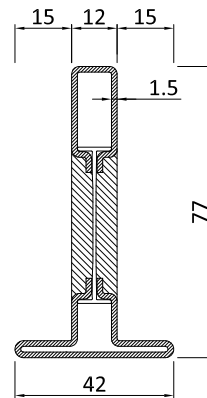

PR2952

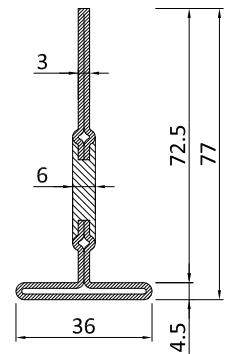

PR2954

Non fornito  
in acciaio inox  
Not in stainless  
steel

Profilo / Profile n°	P Kg/m		A m <sup>2</sup> /m	Jx cm <sup>4</sup>	Jy cm <sup>4</sup>	L m
	ZN / I - CT	OT				
PR2992	4.40	4.67	0.29	27.30	9.45	6
PR2992C	4.39	4.66	0.29	23.61	9.48	3 - 4
PR2993	4.40	4.67	0.29	28.62	9.12	6
PR2995	4.73	5.02	0.32	30.19	11.62	6
PR2947	2.60	2.72	120.57			3 - 4
PR2947CA	1.70	1.79	96.22			3 - 4

Profilo / Profile n°	P Kg/m		A m <sup>2</sup> /m	Jx cm <sup>4</sup>	Jy cm <sup>4</sup>	L m
	ZN / I - CT	OT				
PR2947.3	2.30	2.42	120.57			3 - 4
PR2947C	0.81	0.85	40.93			3 - 4
PR2947CB	2.63	2.75	122.85			3 - 4
PR2952	2.46	2.63	0.23	18.14	2.18	6
PR2954	2.34	2.52	0.22	19.90	1.20	6

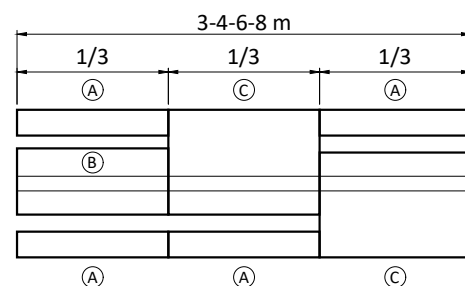
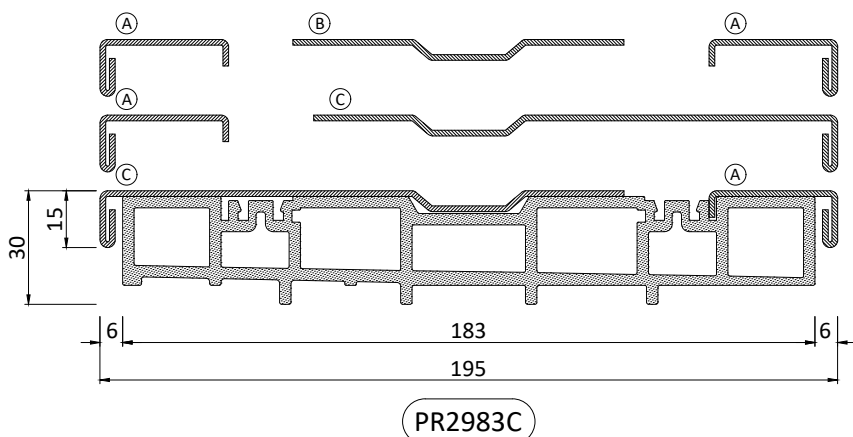
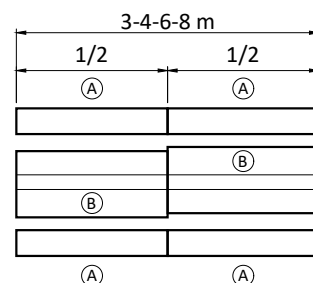
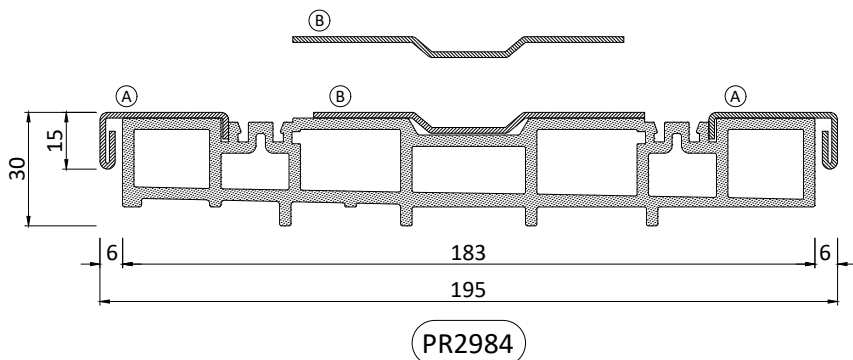
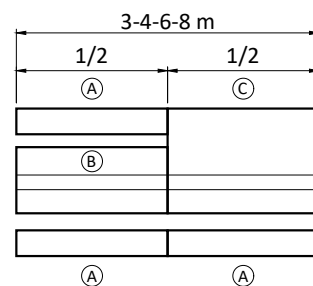
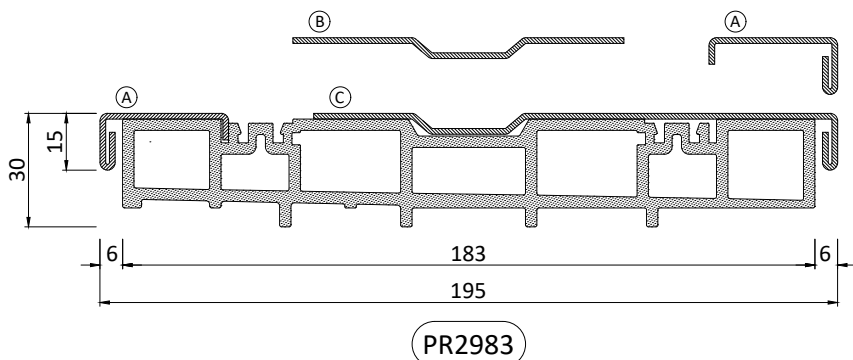

Profilo / Profile n°	P Kg/m		A m <sup>2</sup> /m	Jx cm <sup>4</sup>	Jy cm <sup>4</sup>	L m	Profilo / Profile n°	P Kg/m		A m <sup>2</sup> /m	Jx cm <sup>4</sup>	Jy cm <sup>4</sup>	L m
	ZN / I - CT	OT						ZN / I - CT	OT				
PR2983	4.35	4.58	0.46			3 - 4 - 6 - 8							
PR2984	4.21	4.42	0.44			3 - 4 - 6 - 8							
PR2983C	4.35	4.58	0.46			3 - 4 - 6 - 8							

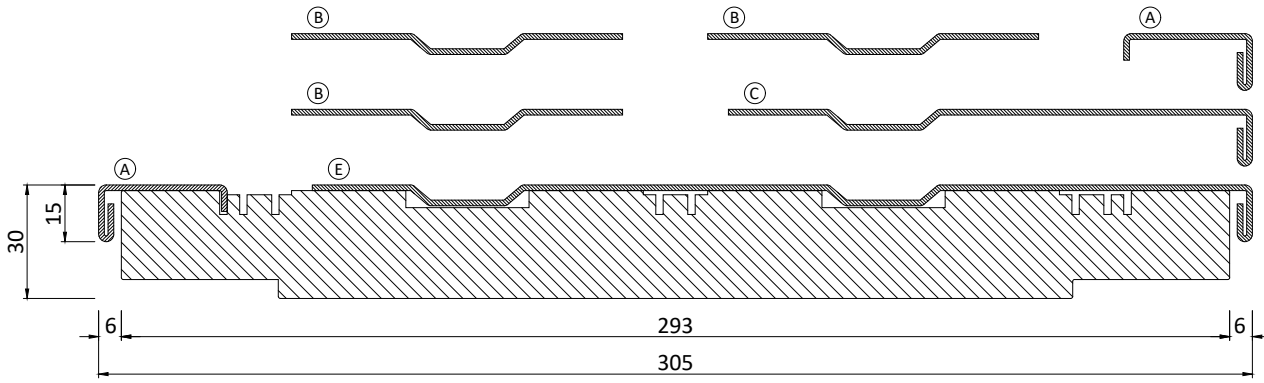

PR2983.3

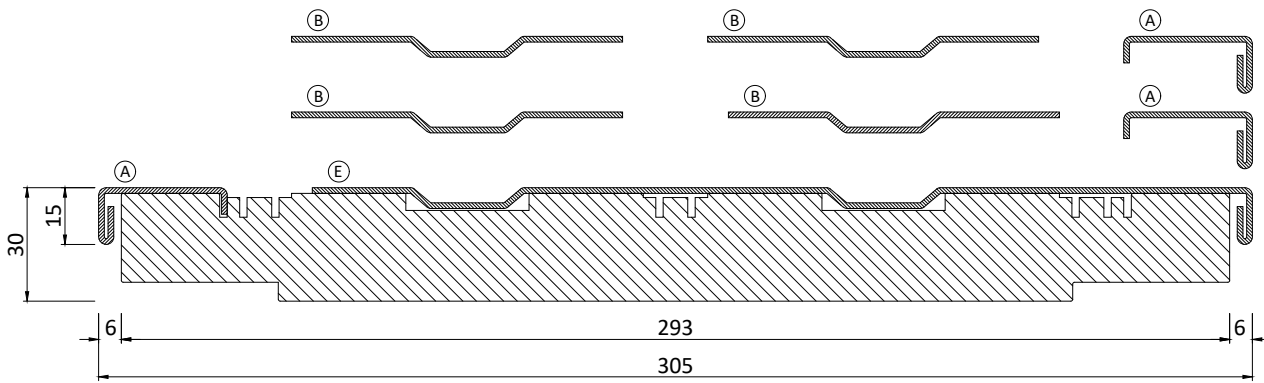
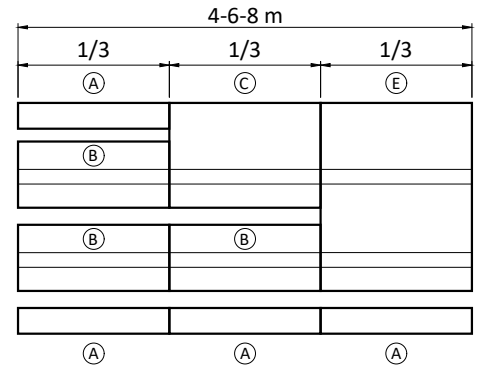

PR2984.3

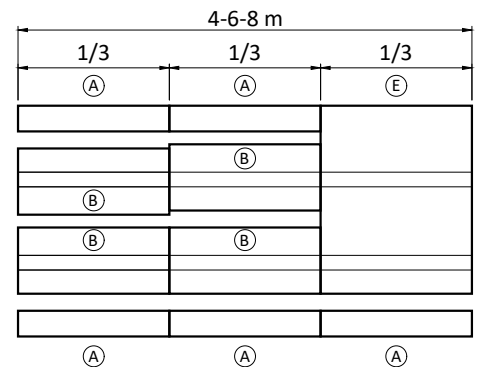

Profilo / Profile n°	P Kg/m		A m <sup>2</sup> /m	Jx cm <sup>4</sup>	Jy cm <sup>4</sup>	L m	Profilo / Profile n°	P Kg/m		A m <sup>2</sup> /m	Jx cm <sup>4</sup>	Jy cm <sup>4</sup>	L m
	ZN / I - CT	OT						ZN / I - CT	OT				
PR2983.3	11.12	11.45	0.68			4 - 6 - 8							
PR2984.3	11.12	11.45	0.68			4 - 6 - 8							

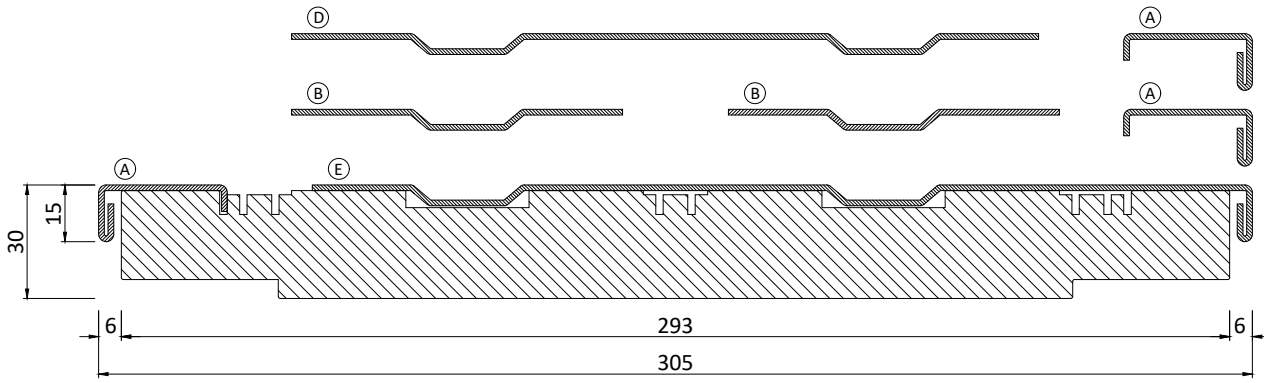

PR2983C3

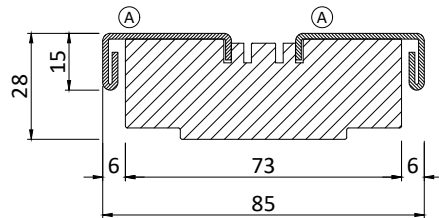
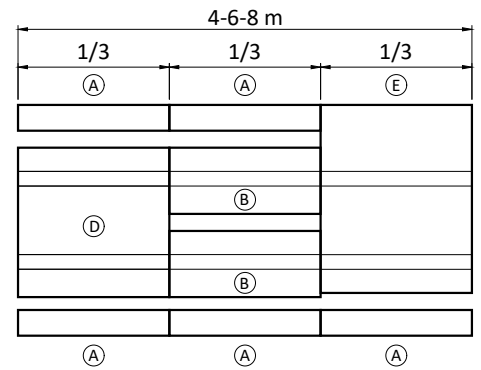

PR2981.1

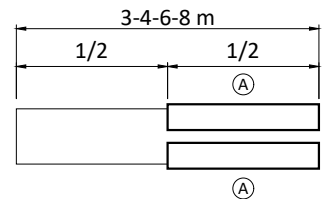

Profilo / Profile n°	P Kg/m		A m <sup>2</sup> /m	Jx cm <sup>4</sup>	Jy cm <sup>4</sup>	L m	Profilo / Profile n°	P Kg/m		A m <sup>2</sup> /m	Jx cm <sup>4</sup>	Jy cm <sup>4</sup>	L m
	ZN / I - CT	OT						ZN / I - CT	OT				
PR2983C3	11.12	11.45	0.68			4 - 6 - 8							
PR2981.1	3.15	3.27	0.25			3 - 4 - 6 - 8							

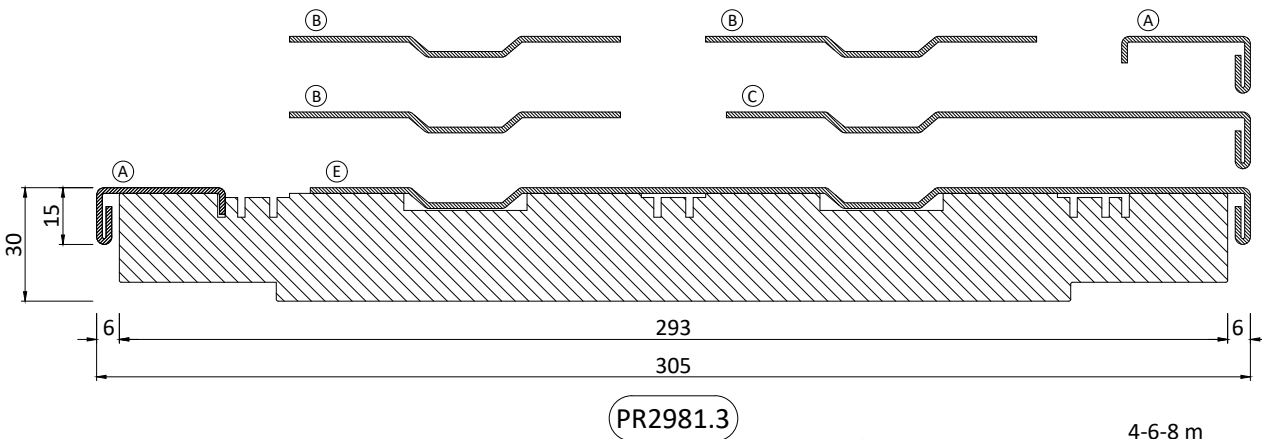
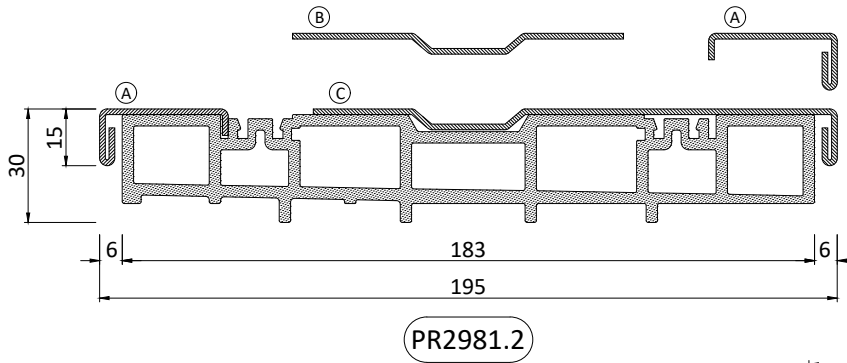

Profilo / Profile n°	P Kg/m		A m <sup>2</sup> /m	Jx cm <sup>4</sup>	Jy cm <sup>4</sup>	L m
	ZN / I - CT	OT				
PR2981.2	4.25	4.47	0.46			4 - 6 - 8
PR2981.3	11.12	11.45	0.68			4 - 6 - 8

Profilo / Profile n°	P Kg/m		A m <sup>2</sup> /m	Jx cm <sup>4</sup>	Jy cm <sup>4</sup>	L m
	ZN / I - CT	OT				



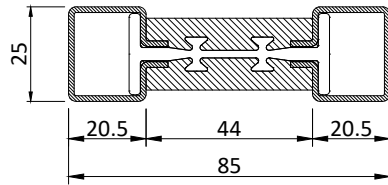

PR1320

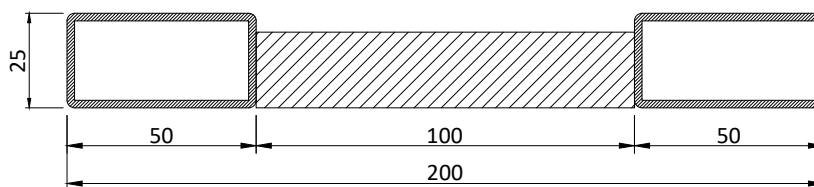

PR1195

Disponibile in acciaio zincato o in acciaio inox  
Available in galvanized steel or stainless steel

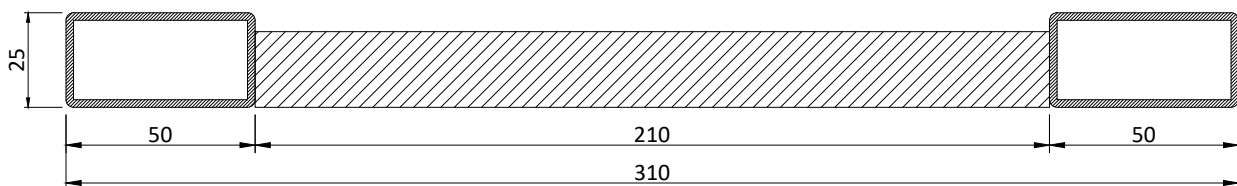

PR1185

Disponibile in acciaio zincato o in acciaio inox  
Available in galvanized steel or stainless steel

Profilo / Profile n°	P Kg/m		A m <sup>2</sup> /m	Jx cm <sup>4</sup>	Jy cm <sup>4</sup>	L m	Profilo / Profile n°	P Kg/m		A m <sup>2</sup> /m	Jx cm <sup>4</sup>	Jy cm <sup>4</sup>	L m
	ZN / I - CT	OT						ZN / I - CT	OT				
PR1320	3.18	3.35	0.22			6							
PR1195	6.30	6.67	0.29		3 - 4 - 6 - 8								
PR1185	8.40	8.77	0.29		4 - 6 - 8								

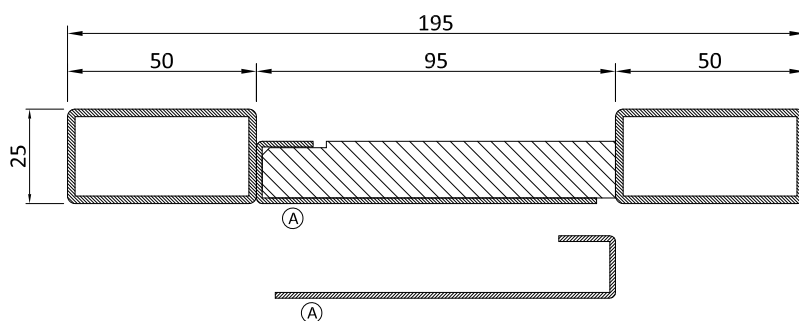

PR2986

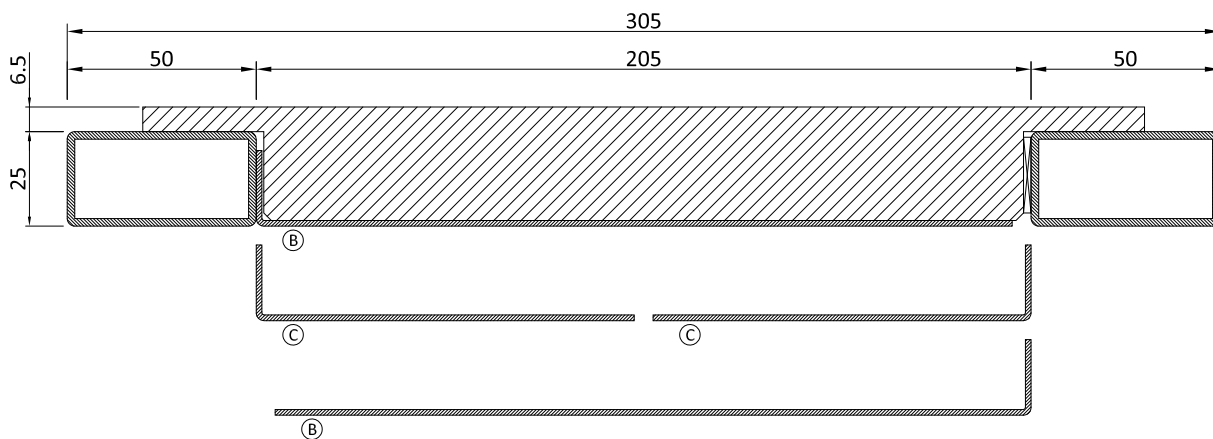
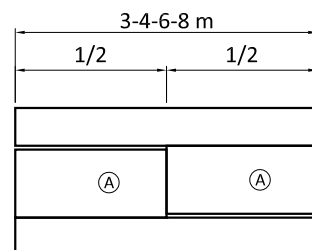

PR2986.3

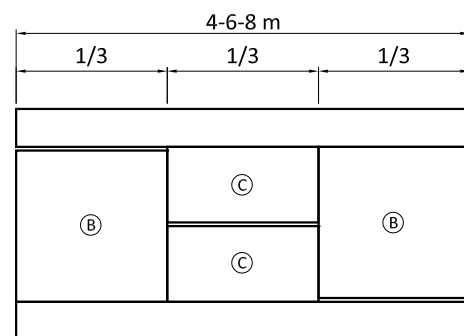

Profilo / Profile n°	P Kg/m		A m <sup>2</sup> /m	Jx cm <sup>4</sup>	Jy cm <sup>4</sup>	L m
	ZN / I - CT	OT				
PR2986	7.10	7.58	0.53			3 - 4 - 6 - 8
PR2986.3	13.30	13.78	0.73			4 - 6 - 8

Profilo / Profile n°	P Kg/m		A m <sup>2</sup> /m	Jx cm <sup>4</sup>	Jy cm <sup>4</sup>	L m
	ZN / I - CT	OT				

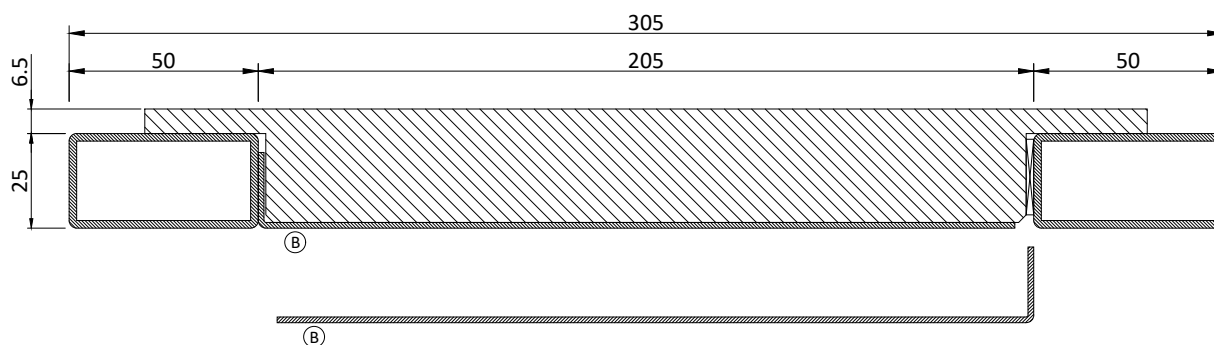

PR2986L.3

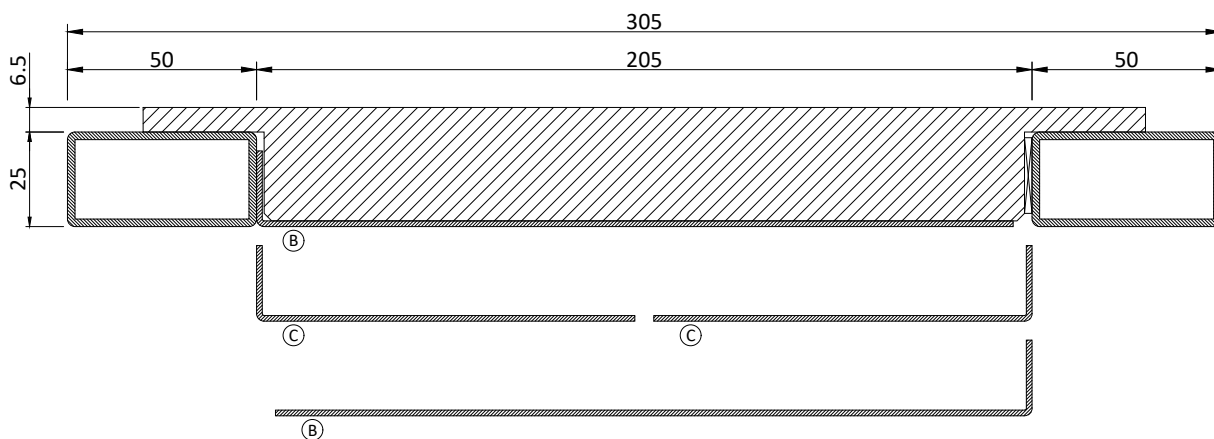
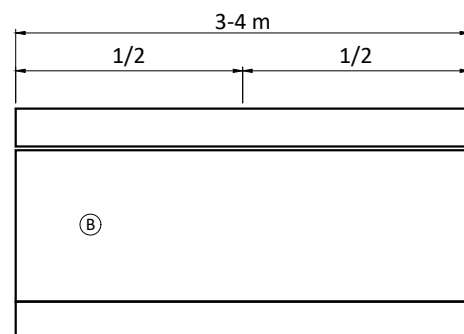

PR2986S3

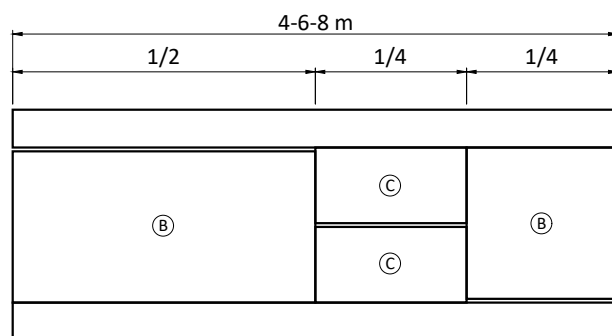

Profilo / Profile n°	P Kg/m		A m <sup>2</sup> /m	Jx cm <sup>4</sup>	Jy cm <sup>4</sup>	L m
	ZN / I - CT	OT				
PR2986L.3	13.20	13.78	0.73			3 - 4
PR2986S3	13.20	13.78	0.73			4 - 6 - 8

Profilo / Profile n°	P Kg/m		A m <sup>2</sup> /m	Jx cm <sup>4</sup>	Jy cm <sup>4</sup>	L m
	ZN / I - CT	OT				

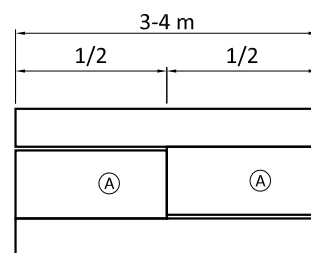
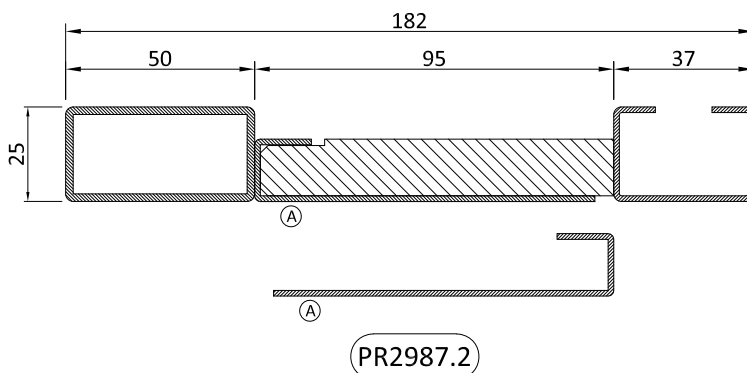
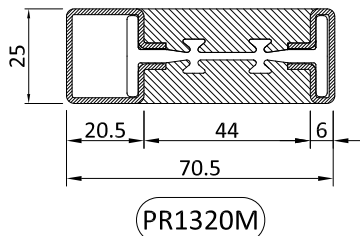

Profilo / Profile n°	P Kg/m		A m <sup>2</sup> /m	Jx cm <sup>4</sup>	Jy cm <sup>4</sup>	L m	Profilo / Profile n°	P Kg/m		A m <sup>2</sup> /m	Jx cm <sup>4</sup>	Jy cm <sup>4</sup>	L m
	ZN / I - CT	OT						ZN / I - CT	OT				
PR1320M	2.85	3.00	0.19			3							
PR2987.2	6.24	6.65	0.53			3 - 4							

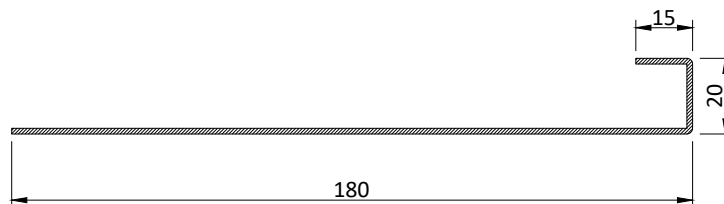

PR1160

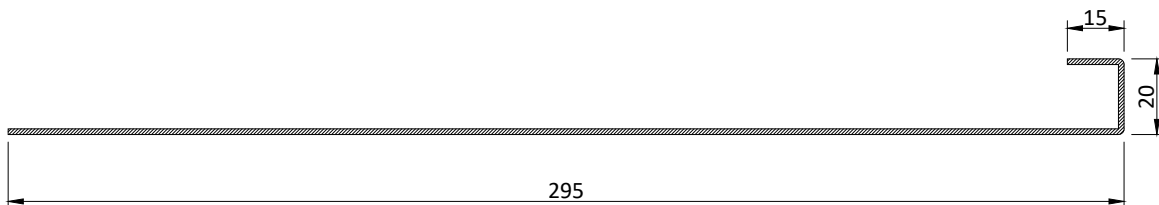

PR1180

Profilo / Profile n°	P		A m <sup>2</sup> /m	Jx cm <sup>4</sup>	Jy cm <sup>4</sup>	L m	Profilo / Profile n°	P		A m <sup>2</sup> /m	Jx cm <sup>4</sup>	Jy cm <sup>4</sup>	L m
	ZN / I - CT	OT						ZN / I - CT	OT				
PR1160	2.49	2.70	0.42			3 - 4							
PR1180	3.85	4.17	0.65			3 - 4							

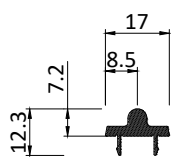

PA1194

PA1194.NE

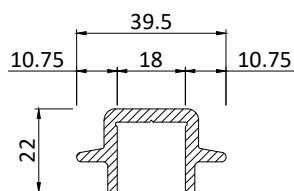

GUM145

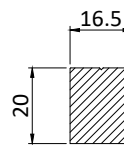

GU2994L

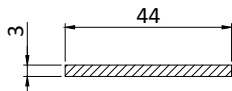

GU1311

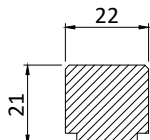

GU2905

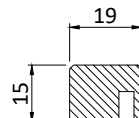

GU2995L

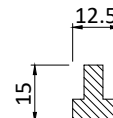

GU2996L

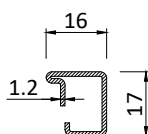

PR2606

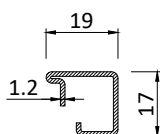

PR2607

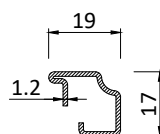

PR2627

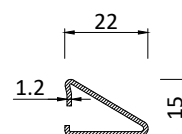

PR2629

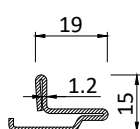

PR2638

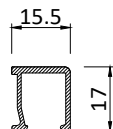

PA2606

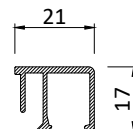

PA2607

## MATERIALE | MATERIAL

PR \_\_\_\_ ZN acciaio zincato | *galvanized steel*PR \_\_\_\_ CZ acciaio corten grezzo | *untreated corteen steel*PR \_\_\_\_ SB acciaio inox scotch brite | *stainless steel scotch brite*PR \_\_\_\_ BR ottone grezzo | *untreated brass*

Profilo / Profile n°	P Kg/m		A m <sup>2</sup> /m	Jx cm <sup>4</sup>	Jy cm <sup>4</sup>	L m	Profilo / Profile n°	P Kg/m		A m <sup>2</sup> /m	Jx cm <sup>4</sup>	Jy cm <sup>4</sup>	L m
	ZN / I - CT	OT						ZN / I - CT	OT				
PA1194 /NE	0,20	Al argento/nero   Al silver/black				3 - 4 - 6	PR2606	0.48	0.52				6
GUM145	0.23	PVC				3 - 4 - 6	PR2607	0.51	0.55				6
GU2994L	0.63	PVC				3	PR2627	0.47	0.51				6
GU1311	0,13	PVC				3	PR2629	0.49	0.53				6
GU2905	0,44	PVC				3	PR2638	0.60	0.68				6
GU2995L	0.24	PVC				3	PA2606	0.17	alluminio   aluminium				6
GU2996L	0.11	PVC				3	PA2607	0.23	alluminio   aluminium				6

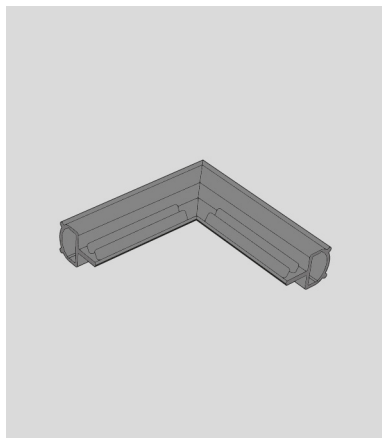
**AC1305G**

Guarnizione d'angolo  
vulcanizzata per GE1305S

*Vulcanised corner weather strip  
for GE1305S*

**AC2993P**

Accessorio assiemaggio telaio  
PR2986

*Frame assembling accessory  
PR2986*

**AC2993PM**

Accessorio assiemaggio telaio  
PR2987.2

*Frame assembling accessory  
PR2987.2*

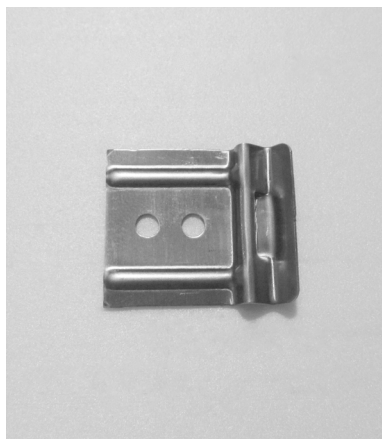
**AC2608**

Clips per fissaggio fermavetri  
PR2629 - PR2638

*Clips for glazing bead  
PR2629 - PR2638*

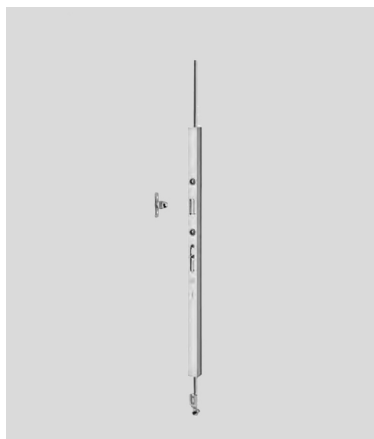
**AG2989L.AB**

Kit prolunga aggiuntiva  
cremonese

*Additional extension kit for  
cremone bolt set*

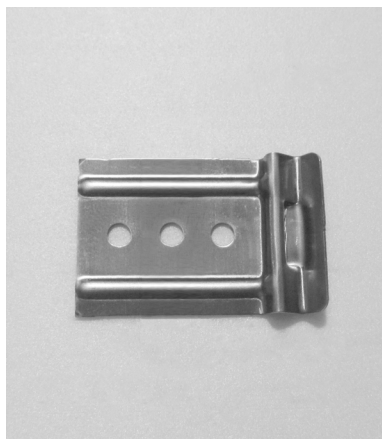
**AC 2608AR**

Clips per fissaggio fermavetri  
PR2606 - PR2607 - PR2627

*Clips for securing  
PR2606 - PR2607 - PR2627*

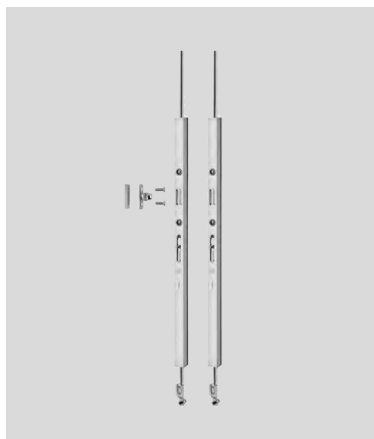
**AG2989L.EF**

Kit prolunga aggiuntiva  
cremonese per soluzione  
coassiale

*Additional extension kit for  
cremone bolt set on coaxial leaf  
solution*

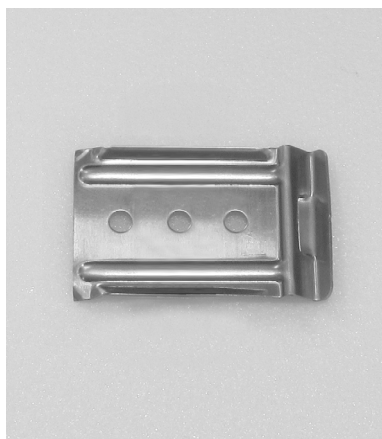
**AC 2609AR**

Clips per fissaggio fermavetri  
su profilo PR2954

*Clips for securing glazing beads  
on PR2954 profile*

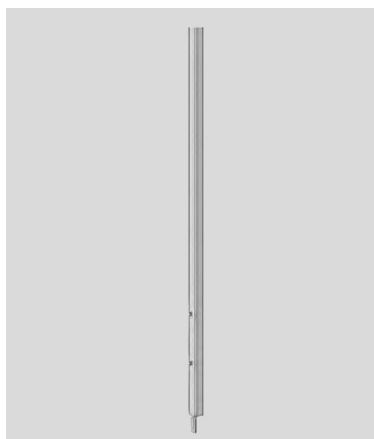
**AG2989 C**

Profilo di copertura aggiuntivo  
cremonese  
H 1000 mm

*Additional covering profile for  
cremone bolt  
H 1000 mm*

**AG2992L.AB**

Rostro aggiuntio

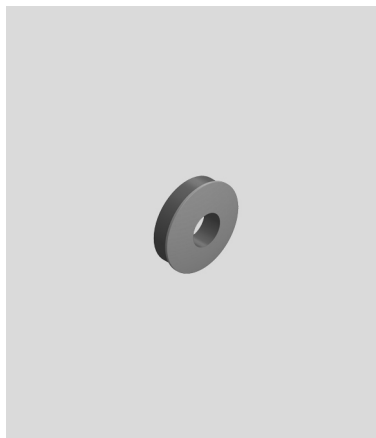
*Additional hook bolt***CV5403 I**

Rondella in acciaio inox/EPDM vulcanizzato per viti di assiemaggio telaio inferiore PR2981.2-2983 - PR2984 con PR1195 e PR2983C con PR1185

*Stainless steel/vulcanised EPDM washer for assembly screws on botom-rail profil PR2981.2-2983 - PR2984 with PR1195 and PR2983C with PR1185***AG2992L.EF**

Rostro aggiuntio per soluzione coassiale

*Additional hook bolt on coaxial leaf solution***CV1243.**

Vite trilobata per boccola CV5012 TPS M4x8

*Thread cutting machine screw for bushing CV5012 TPS M4x8*CV1243 acciaio zincato | galvanized steel  
CV1243I acciaio inox | stainless steel**CV5012.**

Boccola per fermavetro in alluminio PA2606

*Bushing for aluminium glazing bead PA2606*CV5012 acciaio zincato | galvanized steel  
CV5012I acciaio inox | stainless steel



Tabella determinazione range dimensione ante per ordine kit movimentazione e tenuta

Table for sash range for the order of the handling and sealing kit

<b>250 kg</b>	altezza - height					
<b>AG2996-7.xx</b>	1135 1750	1751 2100	2101 2350	2351 2700	2701 2908	
larghezza width	<b>700 - 1925</b>	A1	B1	C1	D1	E1
H maniglia - handle	396	996	996	996	996	

Schema | Type A

**AG2996A.xx**

Kit movimentazione e tenuta  
1 anta apribile - anta DX

portata fino a 250 kg

1 leaf handling and sealing  
kit - RH

load up to 250 kg

Schema | Type B

**AG2997B.xx**

Kit movimentazione e tenuta 2  
ante apribili - 1^ anta SX

portata fino a 250 kg

2 leaf handling and sealing  
kit - LH master

load up to 250 kg

Schema | Type A

**AG2997A.xx**

Kit movimentazione e tenuta  
1 anta apribile - anta SX

portata fino a 250 kg

1 leaf handling and sealing  
kit - LH

load up to 250 kg

Schema | Type C

**AG2996C.xx**

Kit movimentazione e tenuta  
1 anta apribile continua  
anta DX

portata fino a 250 kg

1 continuous leaf handling and  
sealing kit - RH

load up to 250 kg

Schema | Type B

**AG2996B.xx**

Kit movimentazione e tenuta 2  
ante apribili - 1^ anta DX

portata fino a 250 kg

2 leaf handling and sealing  
kit - RH master

load up to 250 kg

Schema | Type C

**AG2997C.xx**

Kit movimentazione e tenuta  
1 anta apribile continua  
anta SX

portata fino a 250 kg

1 continuous leaf handling and  
sealing kit - LH

load up to 250 kg

Schema | Type E

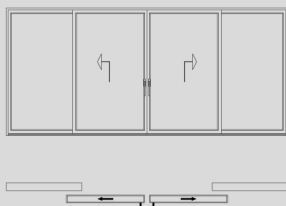
kg  
250**AG2996E.xx**Kit movimentazione e tenuta  
ante apribili coassiali

portata fino a 250 kg

*2 coaxial leaf handling and  
sealing kit**load up to 250 kg*

Schema | Type B3

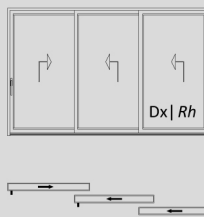
kg  
250**AG2996B3.xx**Kit movimentazione e tenuta  
3 ante - anta DX

portata fino a 250 kg

*3 leaf handling and sealing  
kit - RH**load up to 250 kg*

Schema | Type F

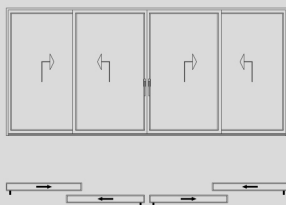
kg  
250**AG2996F.xx**Kit movimentazione e tenuta  
ante apribili coassiali

portata fino a 250 kg

*4 coaxial leaf handling and  
sealing kit**load up to 250 kg*

Schema | Type B3

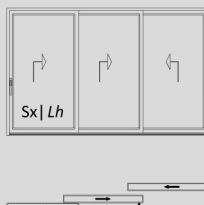
kg  
250**AG2997B3.xx**Kit movimentazione e tenuta  
3 ante - anta SX

portata fino a 250 kg

*3 leaf handling and sealing  
kit - LH**load up to 250 kg*

Schema | Type A3

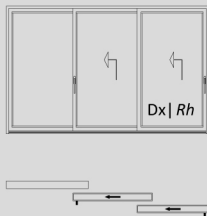
kg  
250**AG2996A3.xx**Kit movimentazione e tenuta  
2 ante - anta DX

portata fino a 250 kg

*2 leaf handling and sealing  
kit - RH**load up to 250 kg*

Schema | Type C3

kg  
250**AG2996C3.xx**Kit movimentazione e tenuta  
2 ante - anta DX

portata fino a 250 kg

*2 leaf handling and sealing  
kit - RH**load up to 250 kg*

Schema | Type A3

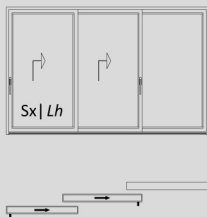
kg  
250**AG2997A3.xx**Kit movimentazione e tenuta  
2 ante - anta SX

portata fino a 250 kg

*2 leaf handling and sealing  
kit - LH**load up to 250 kg*

Schema | Type C3

kg  
250**AG2997C3.xx**Kit movimentazione e tenuta  
2 ante - anta SX

portata fino a 250 kg

*2 leaf handling and sealing  
kit - LH**load up to 250 kg*

Schema | Type E3

kg  
250**AG2996E3.xx**

Kit movimentazione e tenuta 4 ante apribili coassiali

portata fino a 250 kg

4 coaxial leaf handling and sealing kit

load up to 250 kg

Schema | Type S2

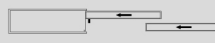
kg  
250**AG2996S2.xx**

Kit movimentazione e tenuta 2 ante a scomparsa - anta DX

portata fino a 250 kg

2 concealed leaf handling and sealing kit - RH

load up to 250 kg

Schema | Type F3

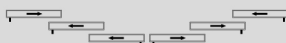
kg  
250**AG2996F3.xx**

Kit movimentazione e tenuta 6 ante apribili coassiali

portata fino a 250 kg

6 coaxial leaf handling and sealing kit

load up to 250 kg

Schema | Type S2

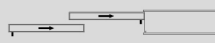
kg  
250**AG2997S2.xx**

Kit movimentazione e tenuta 2 ante a scomparsa - anta SX

portata fino a 250 kg

2 concealed leaf handling and sealing kit - LH

load up to 250 kg

Schema | Type S1

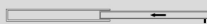
kg  
250**AG2996S1.xx**

Kit movimentazione e tenuta 1 anta scomparsa - anta DX

portata fino a 250 kg

1 concealed leaf handling and sealing kit - RH

load up to 250 kg

Schema | Type S3

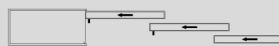
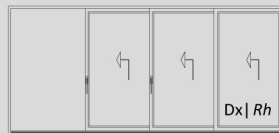
kg  
250**AG2996S3.xx**

Kit movimentazione e tenuta 3 ante a scomparsa - anta DX

portata fino a 250 kg

3 concealed leaf handling and sealing kit - RH

load up to 250 kg

Schema | Type S1

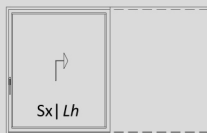
kg  
250**AG2997S1.xx**

Kit movimentazione e tenuta 1 anta scomparsa - anta SX

portata fino a 250 kg

1 concealed leaf handling and sealing kit - LH

load up to 250 kg

Schema | Type S3

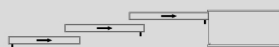
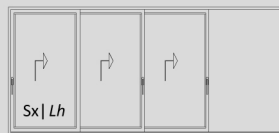
kg  
250**AG2997S3.xx**

Kit movimentazione e tenuta 3 ante a scomparsa - anta SX

portata fino a 250 kg

3 concealed leaf handling and sealing kit - LH

load up to 250 kg

Schema | Type T1

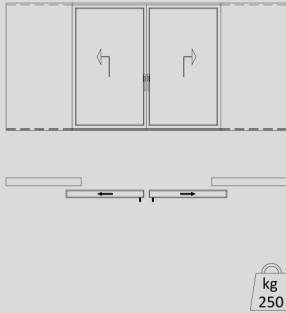
**AG2996T1.xx**

Kit movimentazione e tenuta  
2 ante a scomparsa coassiali

portata fino a 250 kg

*2 coaxial concealed leaf  
handling and sealing kit*

*load up to 250 kg*

Schema | Type T2

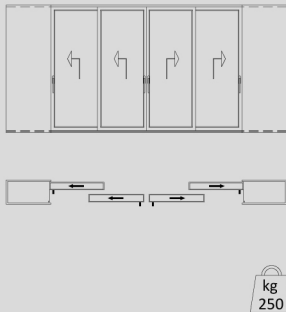
**AG2996T2.xx**

Kit movimentazione e tenuta  
4 ante a scomparsa coassiali

portata fino a 250 kg

*4 coaxial concealed leaf  
handling and sealing kit*

*load up to 250 kg*

Schema | Type T3

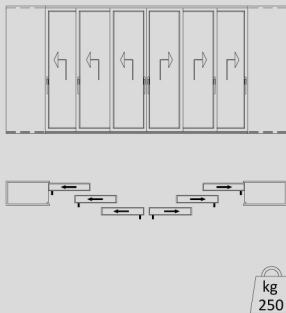
**AG2996T3.xx**

Kit movimentazione e tenuta  
6 ante a scomparsa coassiali

portata fino a 250 kg

*6 coaxial concealed leaf  
handling and sealing kit*

*load up to 250 kg*

Tabelle di determinazione range di utilizzo kit motorizzazione ante

Table for motorisation range kit selection

## 250 kg

	1751 2100	2101 2350	2351 2700	2701 2908
larghezza width	1135 - 1925	B1	C1	D1 E1
H sblocco - unlock	996	996	996	996

Schema | Type A

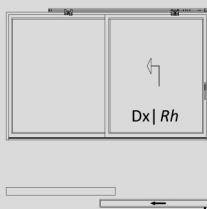

### MG2996A.xx

Kit movimentazione e tenuta per ante motorizzate  
1 anta apribile - anta DX

portata fino a 250 kg

*Motorised leaf handling and sealing kit  
1 leaf - RH*

*load up to 250 kg*

### MBSxxx

Motorizzazione scorrimento vedi pg. 2.3.8  
*Sliding motorisation see pg. 2.3.8*

Schema | Type A

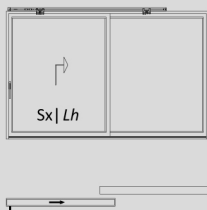

### MG2997A.xx

Kit movimentazione e tenuta per ante motorizzate  
1 anta apribile - anta SX

portata fino a 250 kg

*Motorised leaf handling and sealing kit  
1 leaf - LH*

*load up to 250 kg*

### MBSxxx

Motorizzazione scorrimento vedi pg. 2.3.8  
*Sliding motorisation see pg. 2.3.8*

Schema | Type B

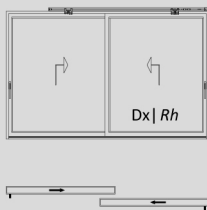

### MG2996B.xx

Kit movimentazione e tenuta per ante motorizzate  
2 ante apribili  
1 anta motorizzata - DX

portata fino a 250 kg

*Motorised leaf handling and sealing kit  
2 leafs  
1 leaf motorised - RH*

*load up to 250 kg*

### MBSxxx

Motorizzazione scorrimento vedi pg. 2.3.8  
*Sliding motorisation see pg. 2.3.8*

Schema | Type B

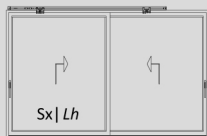
**MG2997B.xx**

Kit movimentazione e tenuta per ante motorizzate  
2 ante apribili  
1 anta motorizzata - SX

portata fino a 250 kg

*Motorised leaf handling and sealing kit  
2 leafs  
1 leaf motorised - LH*

*load up to 250 kg*

**MBSxxx**

Motorizzazione scorrimento vedi pg. 2.3.8  
*Sliding motorisation see pg. 2.3.8*

Schema | Type C

**MG2996C.xx**

Kit movimentazione e tenuta per ante motorizzate  
1 anta apribile - anta DX

portata fino a 250 kg

*Motorised leaf handling and sealing kit  
1 leaf - RH*

*load up to 250 kg*

**MBSxxx**

Motorizzazione scorrimento vedi pg. 2.3.8  
*Sliding motorisation see pg. 2.3.8*

Schema | Type C

**MG2997C.xx**

Kit movimentazione e tenuta per ante motorizzate  
1 anta apribile - anta SX

portata fino a 250 kg

*Motorised leaf handling and sealing kit  
1 leaf - LH*

*load up to 250 kg*

**MBSxxx**

Motorizzazione scorrimento vedi pg. 2.3.8  
*Sliding motorisation see pg. 2.3.8*

Schema | Type E

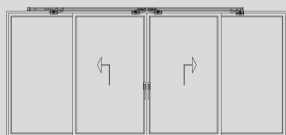
**MG2996E.xx**

Kit movimentazione e tenuta per ante motorizzate  
2 ante apribili coassiali

portata fino a 250 kg

*Motorised leaf handling and sealing kit  
2 coaxial leafs*

*load up to 250 kg*

**MBXxxx**

Motorizzazione scorrimento vedi pg. 2.3.8  
*Sliding motorisation see pg. 2.3.8*

Schema | Type F

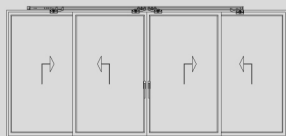
**MG2996F.xx**

Kit movimentazione e tenuta per ante motorizzate  
4 ante apribili  
2 ante coassiali motorizzate

portata fino a 250 kg

*Motorised leaf handling and sealing kit  
4 leafs  
2 coaxial leafs motorised*

*load up to 250 kg*

**MBXxxx**

Motorizzazione scorrimento vedi pg. 2.3.8  
*Sliding motorisation see pg. 2.3.8*

Schema | Type C3

**MG2996C3.xx**

Kit movimentazione e tenuta per ante motorizzate  
1 anta apribile - anta DX

portata fino a 250 kg

*Motorised leaf handling and sealing kit  
1 leaf - RH*

*load up to 250 kg*

**MBSxxx**

Motorizzazione scorrimento vedi pg. 2.3.8  
*Sliding motorisation see pg. 2.3.8*

Schema | Type C3

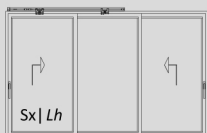
**MG2997C3.xx**

Kit movimentazione e tenuta per ante motorizzate  
1 anta apribile - anta SX

portata fino a 250 kg

*Motorised leaf handling and sealing kit  
1 leaf - LH*

*load up to 250 kg*

**MBSxxx**

Motorizzazione scorrimento vedi pg. 2.3.8  
*Sliding motorisation see pg. 2.3.8*

Schema | Type S1

**MG2996S1.xx**

Kit movimentazione e tenuta per ante motorizzate  
1 anta scomparsa - anta DX

portata fino a 250 kg

*Motorised leaf handling and sealing kit  
1 concealed leaf - RH*

*load up to 250 kg*

**MBSxxx**

Motorizzazione scorrimento vedi pg. 2.3.8  
*Sliding motorisation see pg. 2.3.8*

Schema | Type S1

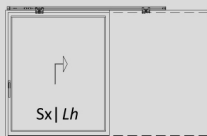
**MG2997S1.xx**

Kit movimentazione e tenuta per ante motorizzate  
1 anta scomparsa - anta SX

portata fino a 250 kg

*Motorised leaf handling and sealing kit  
1 concealed leaf - LH*

*load up to 250 kg*

**MBSxxx**

Motorizzazione scorrimento vedi pg. 2.3.8  
*Sliding motorisation see pg. 2.3.8*

Schema | Type T1

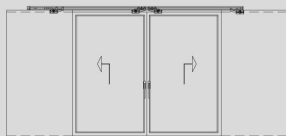
**MG2996T1.xx**

Kit movimentazione e tenuta per ante motorizzate  
2 ante scomparsa coassiali

portata fino a 250 kg

*Motorised leaf handling and sealing kit  
2 concealed coaxial leaves*

*load up to 250 kg*

**MBXxxx**

Motorizzazione scorrimento vedi pg. 2.3.8  
*Sliding motorisation see pg. 2.3.8*

Kit motorizzazione scorrimento (da abbinare al kit movimentazione e tenuta per ante motorizzate MG299xxx.xx)

*Sliding motorisation kit (to be combined with the handling and sealing kit for MG299xxx.xx motorised leaves)*

SCHEMA TYPE	MOTORE MOTOR	LARGHEZZA ANTA SASH WIDTH	LUNGHEZZA MOTORE MOTOR LENGTH
A-B S1	<b>MB S 140</b>	1135 - 1430	2174
C-C3	<b>MB S 200</b>	1431 - 1995	2774
E F	<b>MB X 150</b>	1135 - 1500	3974
T1	<b>MB X 200</b>	1501 - 1995	4974



Profili | Profiles

Prospetto | View  
Vista interna | Internal view

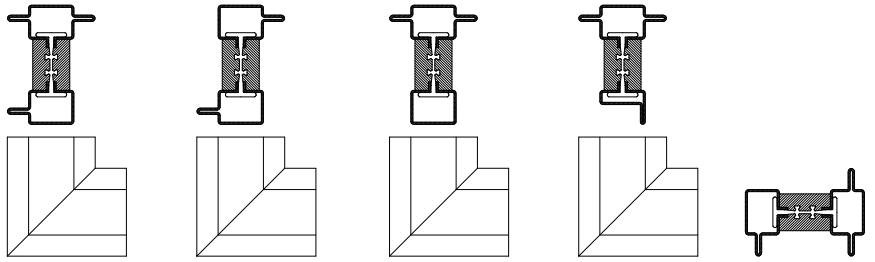

Schema | Type A-B

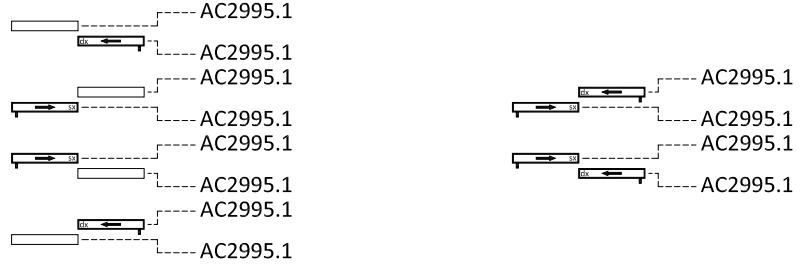
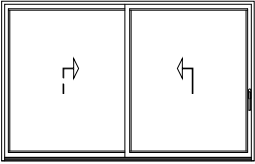

Schema | Type C

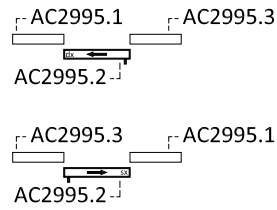
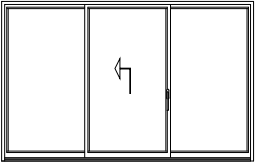

Schema | Type E-F

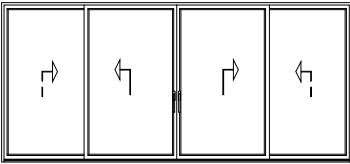

Schema | Type A3-B3

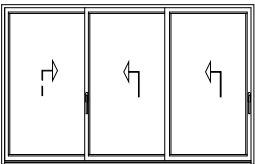

Schema | Type C3

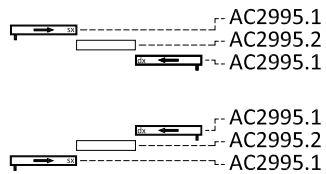
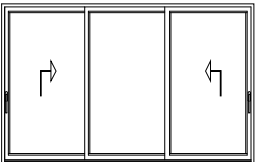

Schema | Type E3-F3

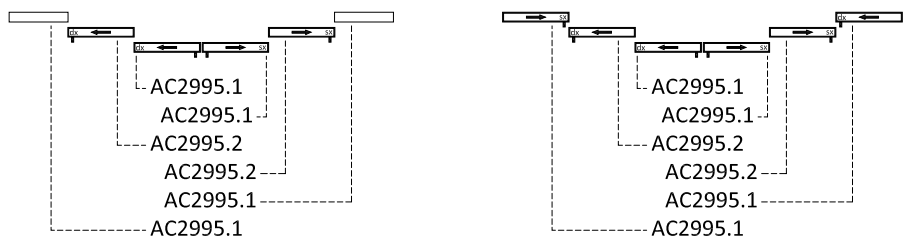
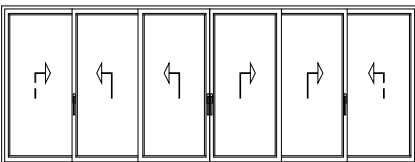

Profili | Profiles

Prospetto | View  
Vista interna | Internal view

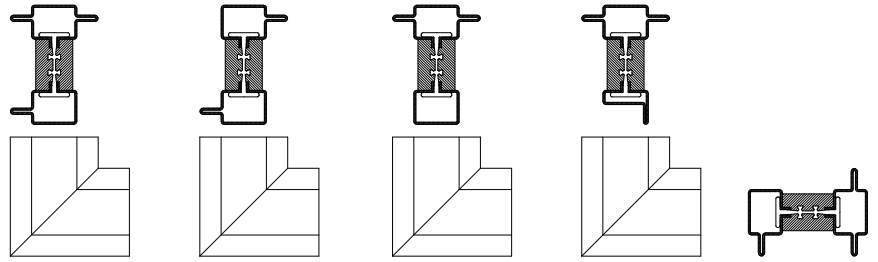

Schema | Type S1

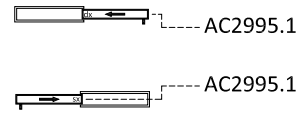
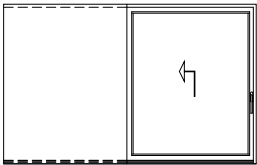

Schema | Type S2

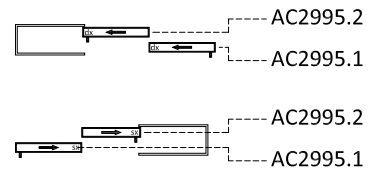
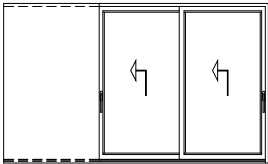

Schema | Type S3

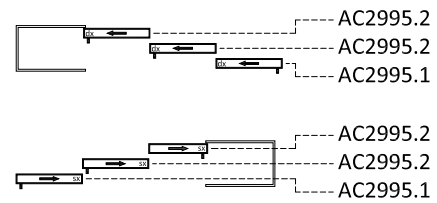
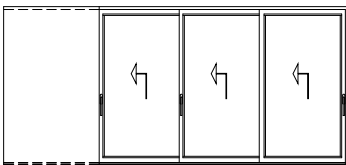

Schema | Type T1

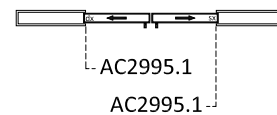
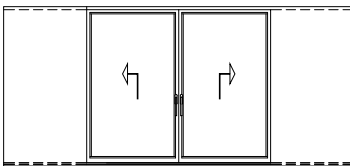

Schema | Type T2

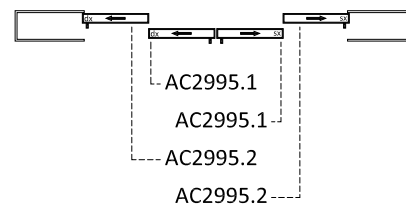
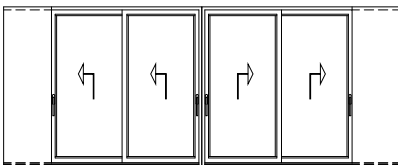

Schema | Type T3

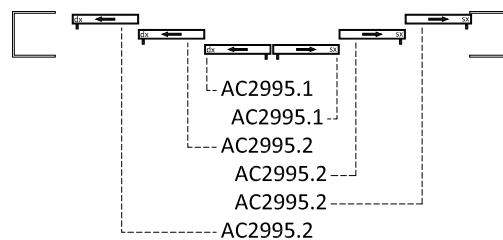
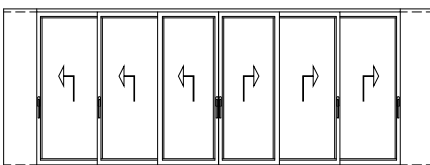

**AC1730I**

Kit per giunzione telaio esterno  
PR1320  
Acciaio inox

*Kit of external frame junction  
PR1320  
Stainless steel*

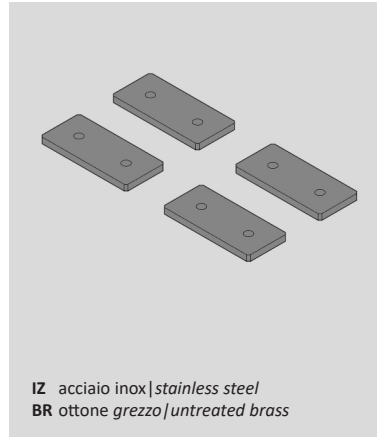
**AC2995R.xx**

Kit piastrelle di giunzione telaio  
esterno  
PR2986-PR2987

*Kit of external frame junction  
plates  
PR2986-PR2987*

IZ acciaio inox | stainless steel  
BR ottone grezzo | untreated brass

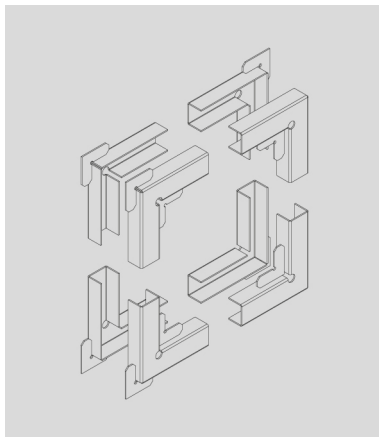
**AC2995.1**

Kit squadrette di giunzione angoli  
per anta apribile o fissa  
PR2995-PR2995-PR2995-PR2992  
PR2995-PR2995-PR2995-PR2993

Acciaio inox

*Corner joint kit for openable or  
fixed sash  
PR2995-PR2995-PR2995-PR2992  
PR2995-PR2995-PR2995-PR2993*

*Stainless steel*

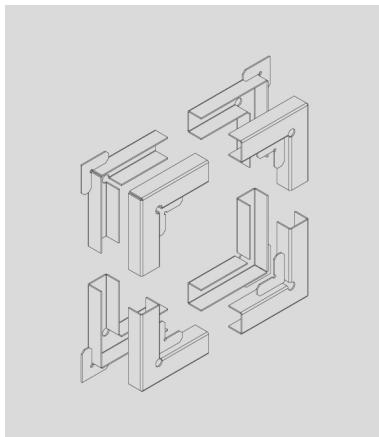
**AC2995.2**

Kit squadrette di giunzione angoli  
per anta centrale apribile o fissa  
PR2995-PR2992-PR2995-PR2993

Acciaio inox

*Corner joint kit for central  
openable or fixed sash  
PR2995-PR2992-PR2995-PR2993*

*Stainless steel*

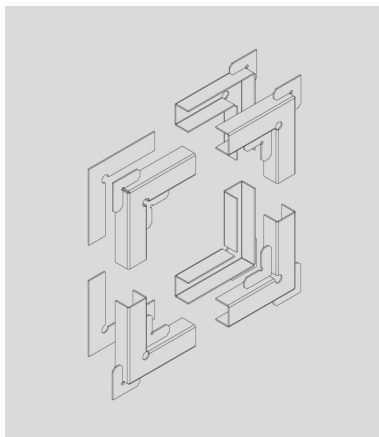
**AC2995.3**

Kit squadrette di giunzione angoli  
per anta fissa  
schema C  
PR2995-PR2992C-PR2995-PR2995

Acciaio inox

*Corner joint kit for fixed sash  
type C  
PR2995-PR2992C-PR2995-PR2995*

*Stainless steel*

**ACV110.xx**

Vaschetta esterna "VITRUVIO"

*"VITRUVIO" External flush handle*

BR ottone grezzo | *untreated brass*  
 BB ottone brunito | *burnished brass*  
 CZ acciaio corten | *corten steel*  
 SB acciaio inox | *stainless steel*  
 IX acciaio inox brunito | *burnished stainless steel*

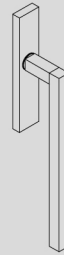
**ACV222.xx**Maniglione singolo "VITRUVIO"  
copertina lunga  
L | quadra | tronca □18*Single "VITRUVIO" handle  
long cover  
L | square | cut □18*

BR ottone grezzo | *untreated brass*  
 BB ottone brunito | *burnished brass*  
 CZ acciaio corten | *corten steel*  
 SB acciaio inox | *stainless steel*  
 IX acciaio inox brunito | *burnished stainless steel*

**ACV212.xx**Maniglione singolo "VITRUVIO"  
copertina corta  
L | quadra | tronca □18*Single "VITRUVIO" handle  
short cover  
L | square | cut □18*

BR ottone grezzo | *untreated brass*  
 BB ottone brunito | *burnished brass*  
 CZ acciaio corten | *corten steel*  
 SB acciaio inox | *stainless steel*  
 IX acciaio inox brunito | *burnished stainless steel*

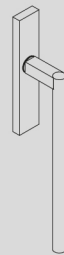
**ACV223.xx**Maniglione singolo "VITRUVIO"  
copertina lunga  
L | tonda | tronca Ø18*Single "VITRUVIO" handle  
long cover  
L | round | cut Ø18*

BR ottone grezzo | *untreated brass*  
 BB ottone brunito | *burnished brass*  
 CZ acciaio corten | *corten steel*  
 SB acciaio inox | *stainless steel*  
 IX acciaio inox brunito | *burnished stainless steel*

**ACV213.xx**Maniglione singolo "VITRUVIO"  
copertina corta  
L | tonda | tronca Ø18*Single "VITRUVIO" handle  
short cover  
L | round | cut Ø18*

BR ottone grezzo | *untreated brass*  
 BB ottone brunito | *burnished brass*  
 CZ acciaio corten | *corten steel*  
 SB acciaio inox | *stainless steel*  
 IX acciaio inox brunito | *burnished stainless steel*

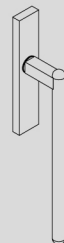
**ACV225.xx**Maniglione singolo "VITRUVIO"  
copertina lunga  
L | tonda | sfera Ø18*Single "VITRUVIO" handle  
long cover  
L | round | sphere Ø18*

BR ottone grezzo | *untreated brass*  
 BB ottone brunito | *burnished brass*  
 CZ acciaio corten | *corten steel*  
 SB acciaio inox | *stainless steel*  
 IX acciaio inox brunito | *burnished stainless steel*

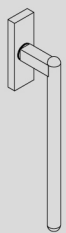
**ACV215.xx**Maniglione singolo "VITRUVIO"  
copertina corta  
L | tonda | sfera Ø18*Single "VITRUVIO" handle  
short cover  
L | round | sphere Ø18*

BR ottone grezzo | *untreated brass*  
 BB ottone brunito | *burnished brass*  
 CZ acciaio corten | *corten steel*  
 SB acciaio inox | *stainless steel*  
 IX acciaio inox brunito | *burnished stainless steel*

**ACV222Y.xx**Maniglione singolo "VITRUVIO"  
copertina lunga con foro chiave  
europea  
L | quadra | tronca □18*Single "VITRUVIO" handle  
long cover with European key  
hole  
L | square | cut □18*

BR ottone grezzo | *untreated brass*  
 BB ottone brunito | *burnished brass*  
 CZ acciaio corten | *corten steel*  
 SB acciaio inox | *stainless steel*  
 IX acciaio inox brunito | *burnished stainless steel*

**ACV223Y.xx**

Maniglione singolo "VITRUVIO"  
copertina lunga con foro chiave  
europea  
L | tonda | tronca Ø18

*Single "VITRUVIO" handle  
long cover with European key  
hole  
L | round | cut Ø18*

**BR** ottone grezzo | *untreated brass*  
**BB** ottone brunito | *burnished brass*  
**CZ** acciaio corten | *corten steel*  
**SB** acciaio inox | *stainless steel*  
**IX** acciaio inox brunito | *burnished stainless steel*

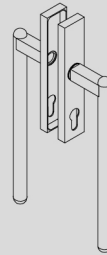
**ACV235Y.xx**

Maniglione doppio "VITRUVIO"  
copertina lunga con foro chiave  
europea  
L | tonda | sfera Ø18

*Double "VITRUVIO" handle  
long cover with European key  
hole  
L | round | sphere Ø18*

**BR** ottone grezzo | *untreated brass*  
**BB** ottone brunito | *burnished brass*  
**CZ** acciaio corten | *corten steel*  
**SB** acciaio inox | *stainless steel*  
**IX** acciaio inox brunito | *burnished stainless steel*

**ACV225Y.xx**

Maniglione singolo "VITRUVIO"  
copertina lunga con foro chiave  
europea  
L | tonda | sfera Ø18

*Single "VITRUVIO" handle  
long cover with European key  
hole  
L | round | sphere Ø18*

**BR** ottone grezzo | *untreated brass*  
**BB** ottone brunito | *burnished brass*  
**CZ** acciaio corten | *corten steel*  
**SB** acciaio inox | *stainless steel*  
**IX** acciaio inox brunito | *burnished stainless steel*

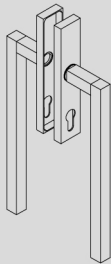
**ACV232Y.xx**

Maniglione doppio "VITRUVIO"  
copertina lunga con foro chiave  
europea  
L | quadra | tronca □18

*Double "VITRUVIO" handle  
long cover with European key  
hole  
L | square | cut □18*

**BR** ottone grezzo | *untreated brass*  
**BB** ottone brunito | *burnished brass*  
**CZ** acciaio corten | *corten steel*  
**SB** acciaio inox | *stainless steel*  
**IX** acciaio inox brunito | *burnished stainless steel*

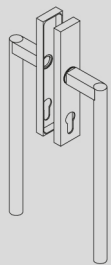
**ACV233Y.xx**

Maniglione doppio "VITRUVIO"  
copertina lunga con foro chiave  
europea  
L | tonda | tronca Ø18

*Double "VITRUVIO" handle  
long cover with European key  
hole  
L | round | cut Ø18*

**BR** ottone grezzo | *untreated brass*  
**BB** ottone brunito | *burnished brass*  
**CZ** acciaio corten | *corten steel*  
**SB** acciaio inox | *stainless steel*  
**IX** acciaio inox brunito | *burnished stainless steel*

**GE1011**

Guarnizione interna fermavetro  
spessore 3-4 mm

*Internal gasket on 3-4 mm thick  
glazing bead*

**GE2905S**

Guarnizione superiore ante

*Top-rail gasket*

**GE1142**

Guarnizione di tenuta labirinto

*Labyrinth sealing gasket*

**GE2907TT**

Guarnizione sotto vetro

*Under glass gasket*

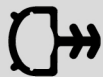
**GE1305S**

Guarnizione laterale e inferiore  
ante

*Sash uproghts an bottom rail  
gasket*

**GP0095**

Guarnizione interna fermavetro  
spessore 3 mm

*Internal glass gasket  
3 mm thick*

**GE2606**

Guarnizione adesiva esterno  
vetro  
vedi pg. 5.1.1

*Adhesive weather strip outer  
window  
see pg. 5.1.2*

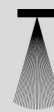
**GU1387**

Spazzolino per labirinto  
H=13 mm

*Brush for labyrinth joint  
H=13 mm*

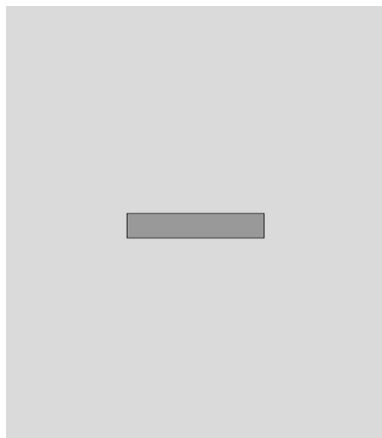
**GU2036**

Piattina adesiva morbida  
per fondo giunto esterno vetro  
12x4 mm

*Soft adhesive shim for  
external window joint  
12x4 mm*

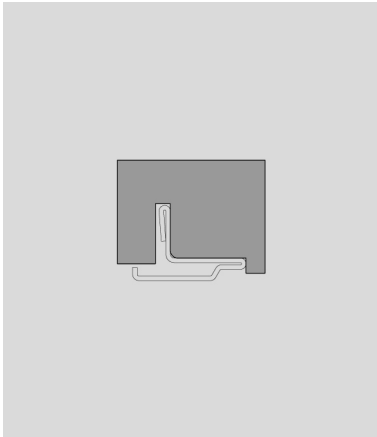
**AT2038**

Ganasce di taglio per  
PR2638

*Cutting jaws for  
PR2638*

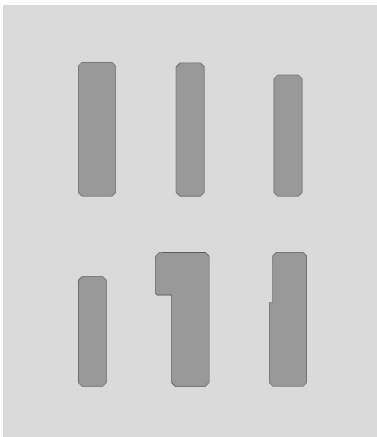
**AT2900**

Kit ganasce di taglio

*Kit of cutting jaws for profiles*

**AT2828**

Maschera per esecuzione fori  
fissaggio fermavetri

*Drill jig for glazing beads  
securing*

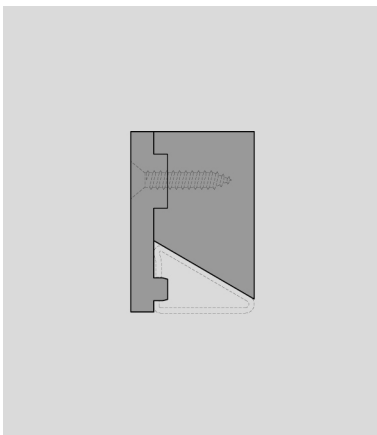
**AT2829**

Ganasce di taglio per  
fermavetro PR2629

*Kit of cutting jaws  
for glazin bead PR2629*



**SA005/01**

Liquido neritore per brunitura  
1 Kg

*Burnishing liquid*  
1 Kg

**SA005/10**

Liquido neritore per brunitura  
10 Kg

*Burnishing liquid*  
10 Kg

**SA2031**

Liquido deumidificante vetri

*Glass dehumidifying liquid*

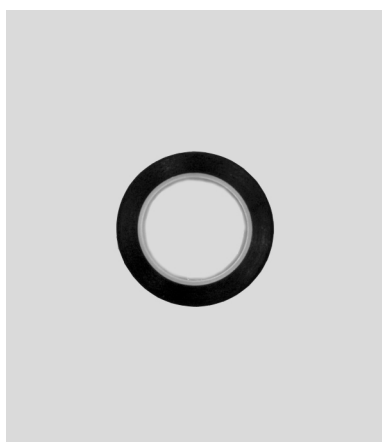
**SA1033**

Nastro adesivo protettivo per  
verniciatura  
33 mm

*Adhesive tape for painting*  
33 mm

**SA2032**

Primer di adesione per profili  
verniciati

*Adhesion primer for painted  
profiles*

**SA2001**

Spray detergente antimpronta  
per superfici in acciaio inox

*Anti-fingerprint detergent spray  
for stainless steel surfaces*

**SA2033**

Liquido di adesione per  
materiale plastico

*Adhesion liquid for plastic*

**SA2002**

Spray solvente per rimozione  
collanti su superfici in acciaio  
inox

*Solvent adhesive remover spray  
for stainless steel surfaces*

**SA3001**

Acido per ossidazione corten

*Oxidising acid for corten*

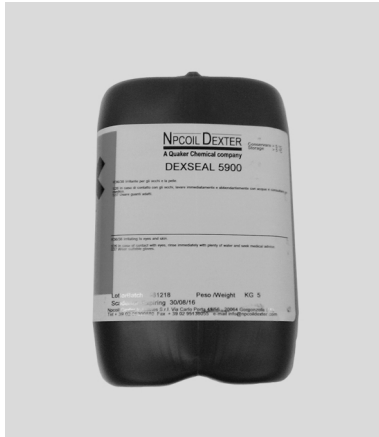
**SA3002**

Passivante per ossidazione corten  
25 Kg

*Passivating agent for corten  
25 Kg*

**SA3002/5**

Passivante per ossidazione corten  
5 Kg

*Passivating agent for corten  
5 Kg*

**SL0022**

Adesivo cianoacrilico per  
tamponi in neoprene

*Cyanoacrylic adhesive for  
neoprene pads*

**SA3003**

Cera d'api per finitura corten

*Beeswax for Corten finishing*

**SL0019**

Sigillante a freddo per giunzione  
angoli e traversi

*Cold sealant for corner and  
transom joints*

1 kg

**SL0021**

Silicone nero per guarnizioni

*Black silicone for gaskets*

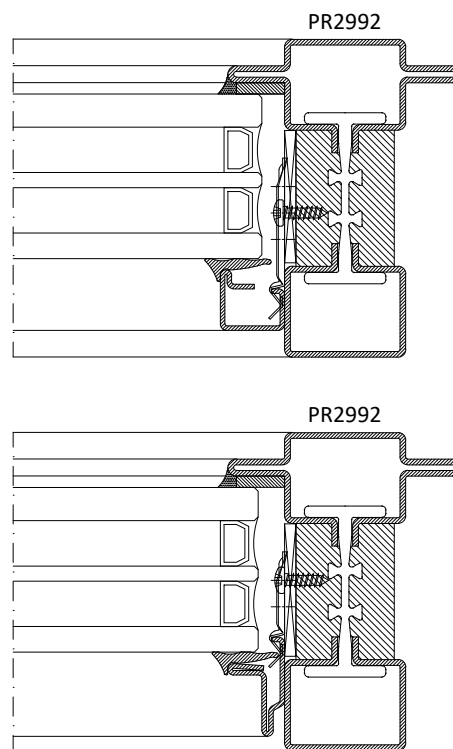
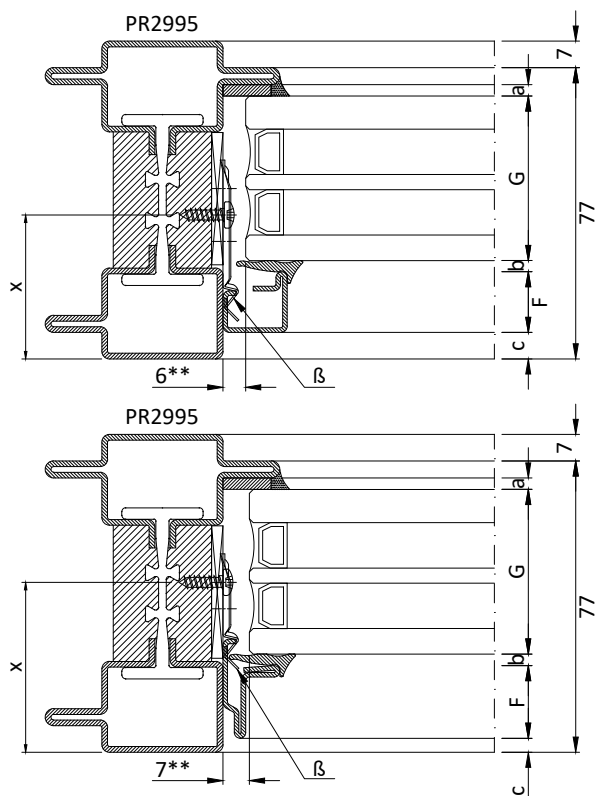

F	G	Guarnizioni - gasket		asse fissaggio viti fermavetro glazing beads securing axis	rientro fermavetro glazing beads gap	clips fissaggio fermavetro glazing beads securing clips
		GU2036 3 mm + sigillatura + seal	GP0095 2 / 3 mm			
fermavetro glazing beads	spessore vetro glass thickness					
codice code	mm					
 PR2606	35 - 51			47 - 31	16 - 0	AC2608AR*
 PR2607	35 - 48			44 - 31	13 - 0	AC2608AR*
 PR2627	35 - 48	3	3	44 - 31	13 - 0	AC2608AR*
 PR2629	35 - 45			52 - 42	10 - 0	AC2608AR*
 PR2638	35 - 48			54.5 - 41.5	13 - 0	AC2608

\* fissare tramite il secondo foro della clip

\* screw in the second hole of the clip

\*\* 7 mm per PR2638

\*\* 7 mm for PR2638

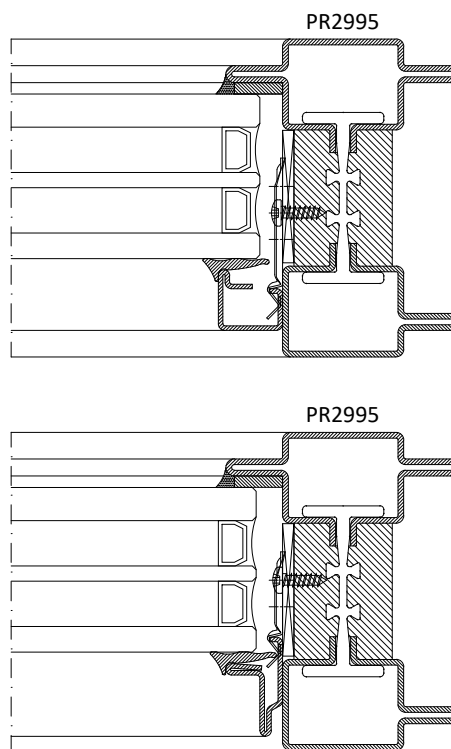
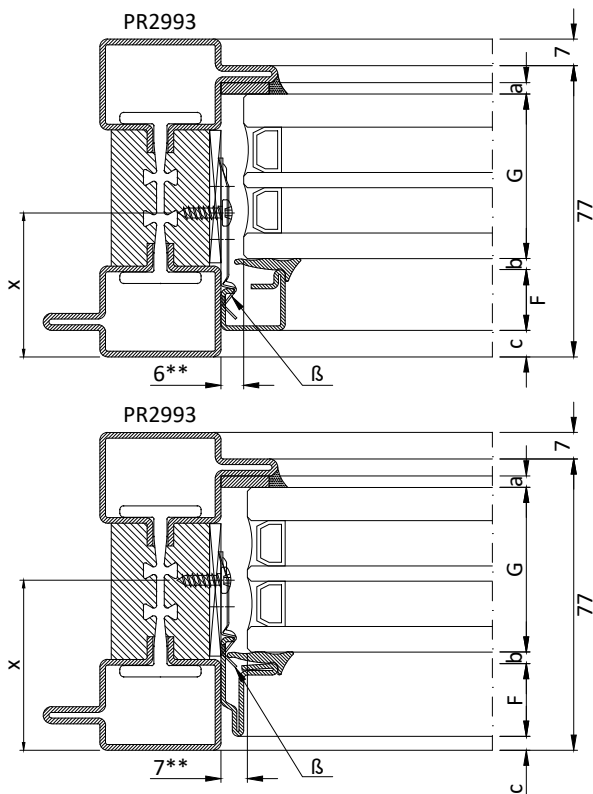

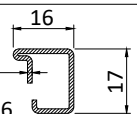
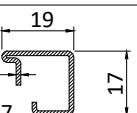
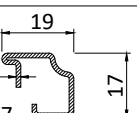
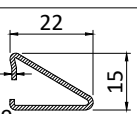
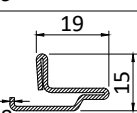
F	G	Guarnizioni - gasket		asse fissaggio viti fermavetro glazing beads securing axis	rientro fermavetro glazing beads gap	clips fissaggio fermavetro glazing beads securing clips
		GU2036 3 mm + sigillatura + seal	GP0095 2 / 3 mm			
fermavetro glazing beads	spessore vetro glass thickness					
codice code	mm					
 PR2606	35 - 51			47 - 31	16 - 0	AC2608AR*
 PR2607	35 - 48			44 - 31	13 - 0	AC2608AR*
 PR2627	35 - 48	3	3	44 - 31	13 - 0	AC2608AR*
 PR2629	35 - 45			52 - 42	10 - 0	AC2608AR*
 PR2638	35 - 48			54.5 - 41.5	13 - 0	AC2608

\* fissare tramite il secondo foro della clip  
 \* screw in the second hole of the clip  
 \*\* 7 mm per PR2638  
 \*\* 7 mm for PR2638

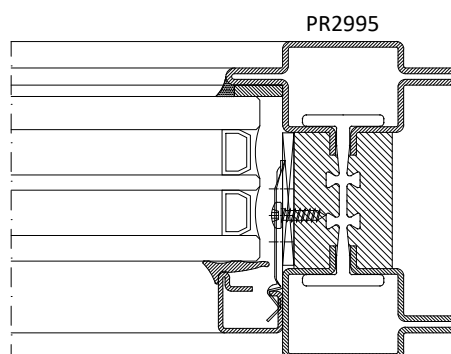
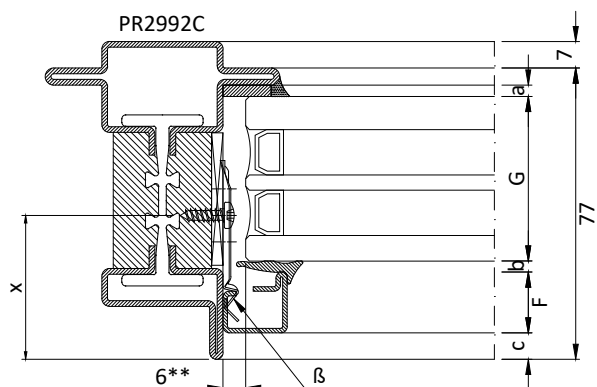

F	G	Guarnizioni - gasket				
fermavetro glazing beads	spessore vetro glass thickness	GU2036 3 mm + sigillatura + seal	GP0095 2 / 3 mm	asse fissaggio viti fermavetro glazing beads securing axis	rientro fermavetro glazing beads gap	clips fissaggio fermavetro glazing beads securing clips
codice code	mm	a	b	x	c	β
 PR2606	44	3	3	38	7	AC2608AR*
 PR2607	41			38	7	AC2608AR*
 PR2627	Non utilizzabile su PR2992C Cannot be used on PR2992C					
 PR2629	Non utilizzabile su PR2992C Cannot be used on PR2992C					
 PR2638	Non utilizzabile su PR2992C Cannot be used on PR2992C					

\* fissare tramite il secondo foro della clip  
 \* screw in the second hole of the clip  
 \*\* 7 mm per PR2638  
 \*\* 7 mm for PR2638

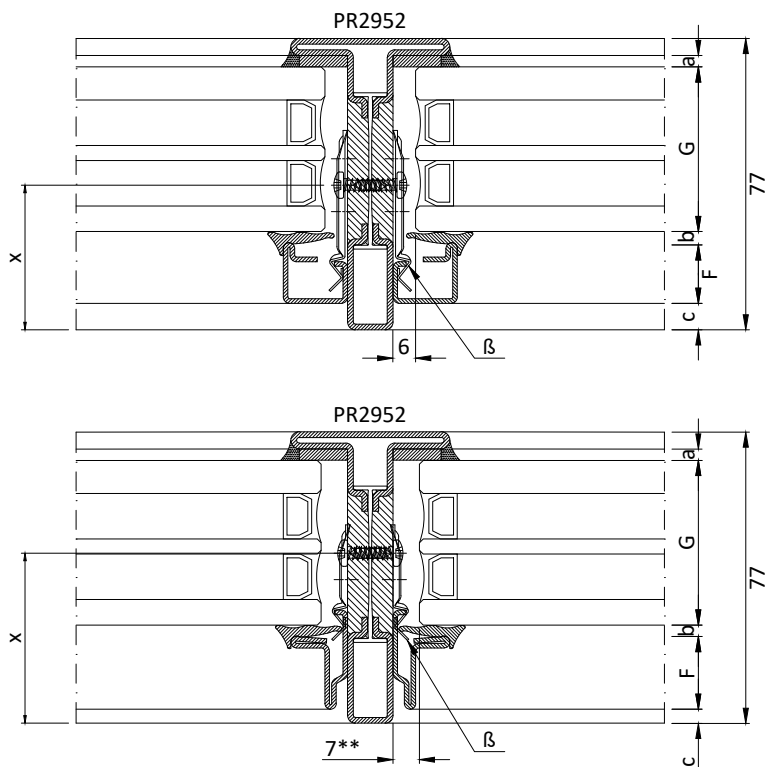

F	G	Guarnizioni - gasket		asse fissaggio viti fermavetro glazing beads securing axis	rientro fermavetro glazing beads gap	clips fissaggio fermavetro glazing beads securing clips
		GU2036 3 mm + sigillatura + seal	GP0095 2 / 3 mm			
PR2606 	35 - 51	3	3	47 - 31	16 - 0	AC2608AR*
PR2607 	35 - 48			44 - 31	13 - 0	AC2608AR*
PR2627 	35 - 48			44 - 31	13 - 0	AC2608AR*
PR2629 	35 - 45			52 - 42	10 - 0	AC2608AR*
PR2638 	35 - 48			54.5 - 41.5	13 - 0	AC2608

\* fissare tramite il secondo foro della clip

\* screw in the second hole of the clip

\*\* 7 mm per PR2638

\*\* 7 mm for PR2638

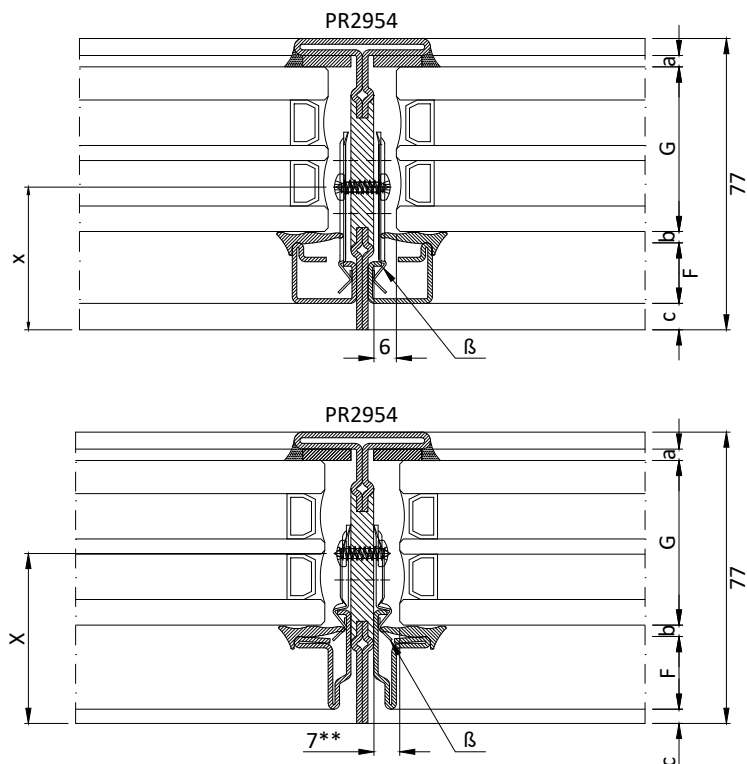

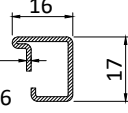
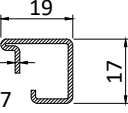
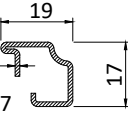
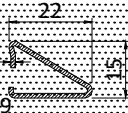
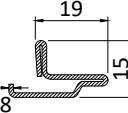
F	G	Guarnizioni - gasket		asse fissaggio viti fermavetro glazing beads securing axis	rientro fermavetro glazing beads gap	boccole e viti fissaggio fermavetro Bushings and screws for fixing of glazing bead
		GU2036 3 mm + sigillatura + seal	GP0095 2 / 3 mm			
 PR2606	43 - 51!!			39 - 31	8 - 0	AC2609AR*
 PR2607	40 - 48	3	3	39 - 31	8 - 0	AC2609AR*
 PR2627	40 - 48			39 - 31	8 - 0	AC2609AR*
 PR2629	Non utilizzabile su PR2954 Cannot be used on PR2954					
 PR2638	35 - 48			54.5 - 41.5	13 - 0	AC2608

\* fissare tramite il secondo foro della clip  
 \* screw in the second hole of the clip  
 \*\* 7 mm per PR2638  
 \*\* 7 mm for PR2638

!! da 43 a 51 mm fissare tramite il secondo foro della clip  
 con rondella di spessoramento da 1 mm  
 !! from 43 to 51 mm fix through the second hole of the clip  
 with shim washer of 1 mm

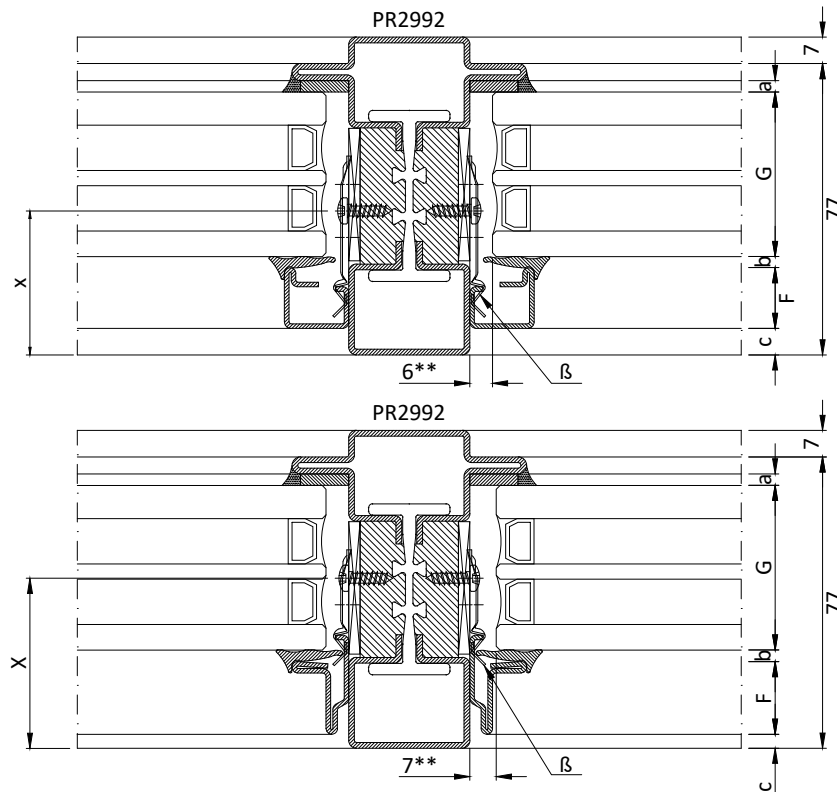

F	G	Guarnizioni - gasket		asse fissaggio viti fermavetro glazing beads securing axis	rientro fermavetro glazing beads gap	clips fissaggio fermavetro glazing beads securing clips
		GU2036 3 mm + sigillatura + seal	GP0095 2 / 3 mm			
PR2606 	35 - 51	3	3	47 - 31	16 - 0	AC2608AR*
PR2607 	35 - 48			44 - 31	13 - 0	AC2608AR*
PR2627 	35 - 48			44 - 31	13 - 0	AC2608AR*
PR2629 	35 - 45			52 - 42	10 - 0	AC2608AR*
PR2638 	35 - 48			54.5 - 41.5	13 - 0	AC2608

\* fissare tramite il secondo foro della clip

\* screw in the second hole of the clip

\*\* 7 mm per PR2638

\*\* 7 mm for PR2638



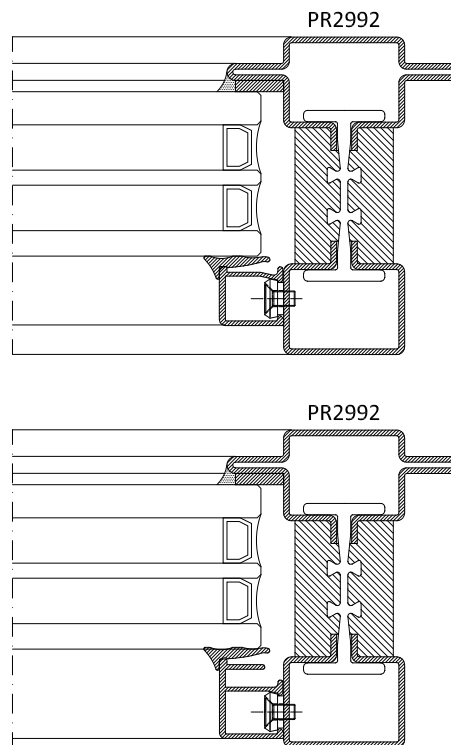
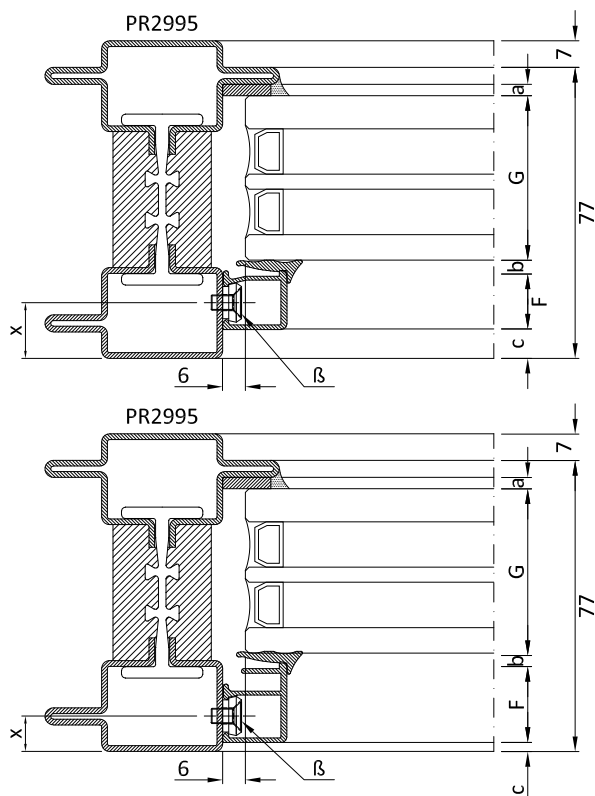

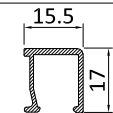
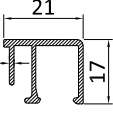
F	G	Guarnizioni - gasket		asse fissaggio viti fermavetro glazing beads securing axis	rientro fermavetro glazing beads gap	clips fissaggio fermavetro glazing beads securing clips
		GU2036 3 mm + sigillatura + seal	GP0095 2 / 3 mm			
fermavetro glazing beads	spessore vetro glass thickness	a	b	x	c	β
codice code	mm	a	b	x	c	β
PA2606 	40 - 51	3	3	18 - 7	11 - 0	CV1243(I) CV5012(I)
PA2607 	35 - 46			18 - 7	11 - 0	CV1243(I) CV5012(I)

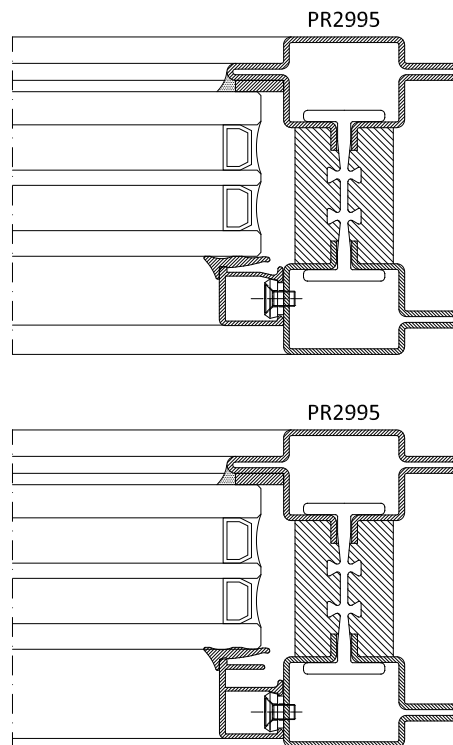
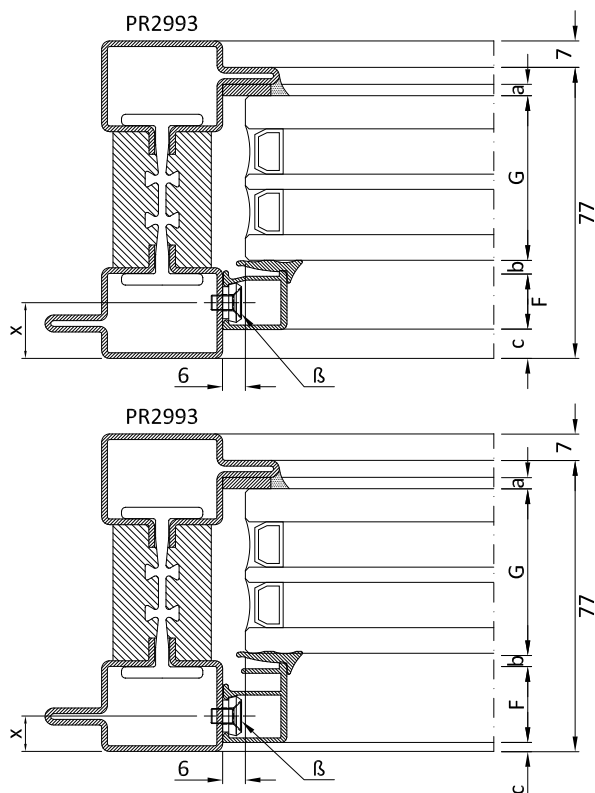

F	G	Guarnizioni - gasket		asse fissaggio viti fermavetro glazing beads securing axis	rientro fermavetro glazing beads gap	clips fissaggio fermavetro glazing beads securing clips
		GU2036 3 mm + sigillatura + seal	GP0095 2 / 3 mm			
fermavetro glazing beads	spessore vetro glass thickness	a	b	x	c	β
codice code	mm	a	b	x	c	β
PA2606 	40 - 51	3	3	18 - 7	11 - 0	CV1243(I) CV5012(I)
PA2607 	35 - 46			18 - 7	11 - 0	CV1243(I) CV5012(I)

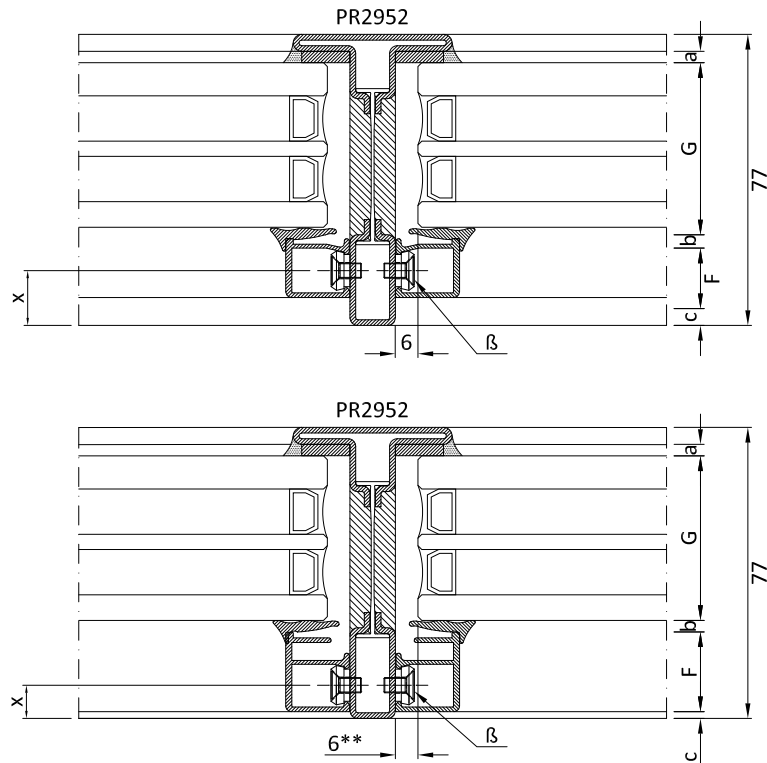

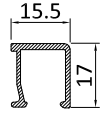
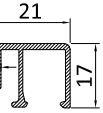
F	G	Guarnizioni - gasket				
fermavetro glazing beads	spessore vetro glass thickness	GU2036 3 mm + sigillatura + seal	GP0095 2 / 3 mm	asse fissaggio viti fermavetro glazing beads securing axis	rientro fermavetro glazing beads gap	clips fissaggio fermavetro glazing beads securing clips
codice code	mm	a	b	x	c	β
PA2606 	40 - 51	3	3	18 - 7	11 - 0	CV1243(I) CV5012(I)
PA2607 	35 - 46			18 - 7	11 - 0	CV1243(I) CV5012(I)

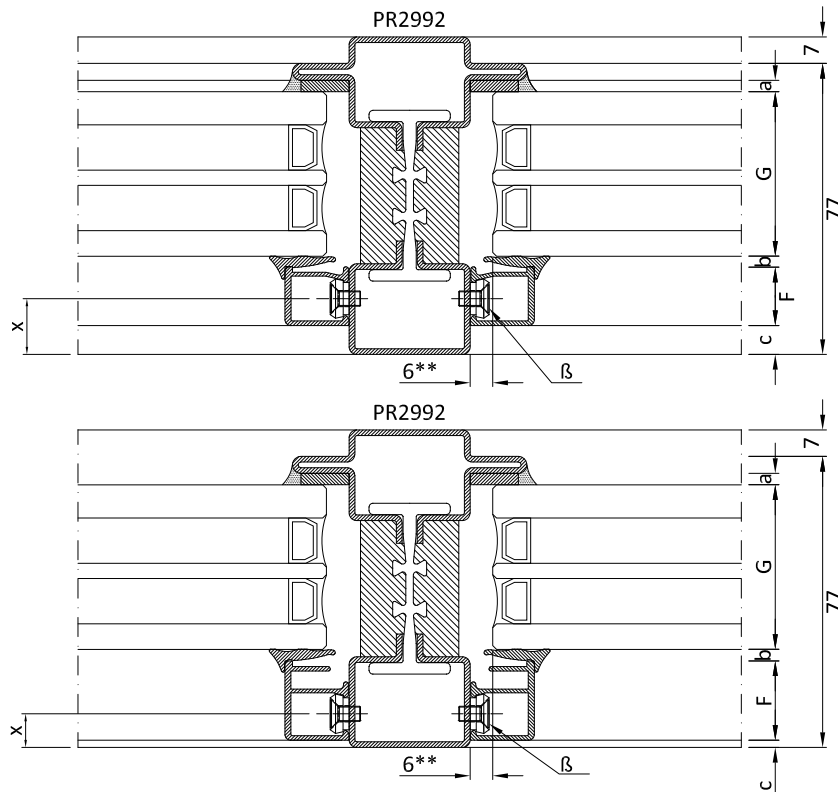

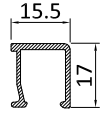
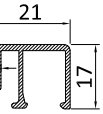
F	G	Guarnizioni - gasket				
fermavetro glazing beads	spessore vetro glass thickness	GU2036 3 mm + sigillatura + seal	GP0095 2 / 3 mm	asse fissaggio viti fermavetro glazing beads securing axis	rientro fermavetro glazing beads gap	clips fissaggio fermavetro glazing beads securing clips
codice code	mm	a	b	x	c	β
PA2606 	40 - 51	3	3	18 - 7	11 - 0	CV1243(I) CV5012(I)
PA2607 	35 - 46			18 - 7	11 - 0	CV1243(I) CV5012(I)

Fissaggio fermavetri PR2606-PR2607-PR2627-PR2629-PR2638: clip AC2608/AC2608AR/AC2609AR con vite TC 3.5 x 9.5 (non fornite)  
 Glazing beads fixing PR2606-PR2607-PR2627-PR2629-PR2638: clip AC2608/AC2608AR/AC2609AR with screw TC 3.5 x 9.5 (not included)

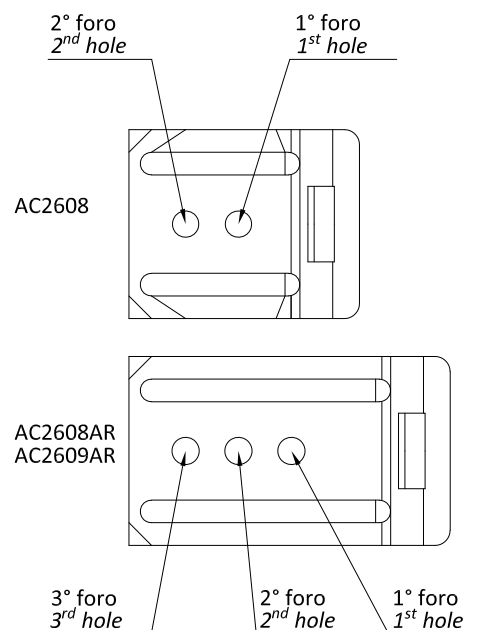
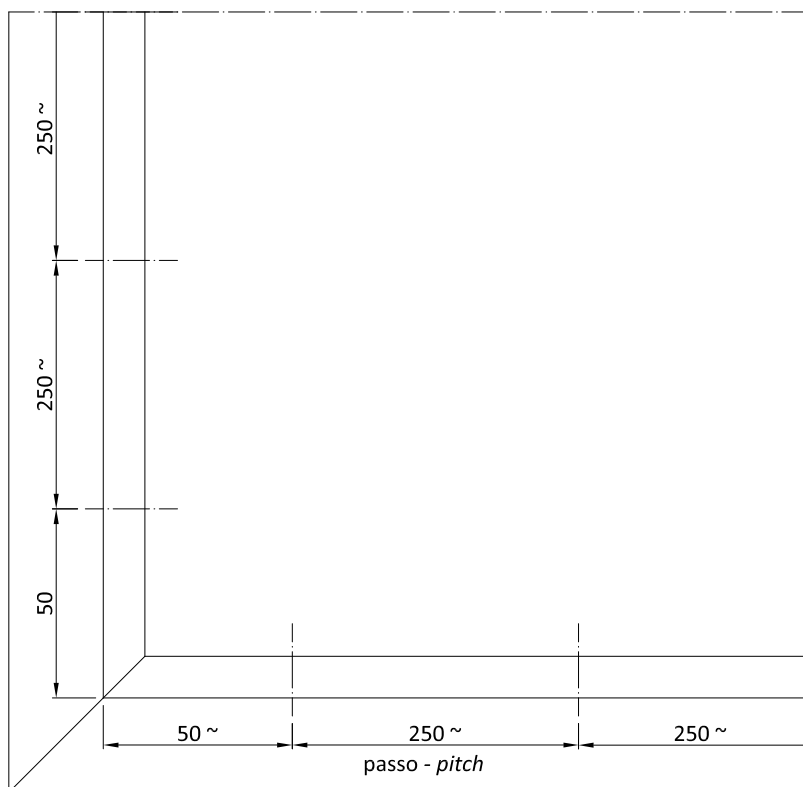
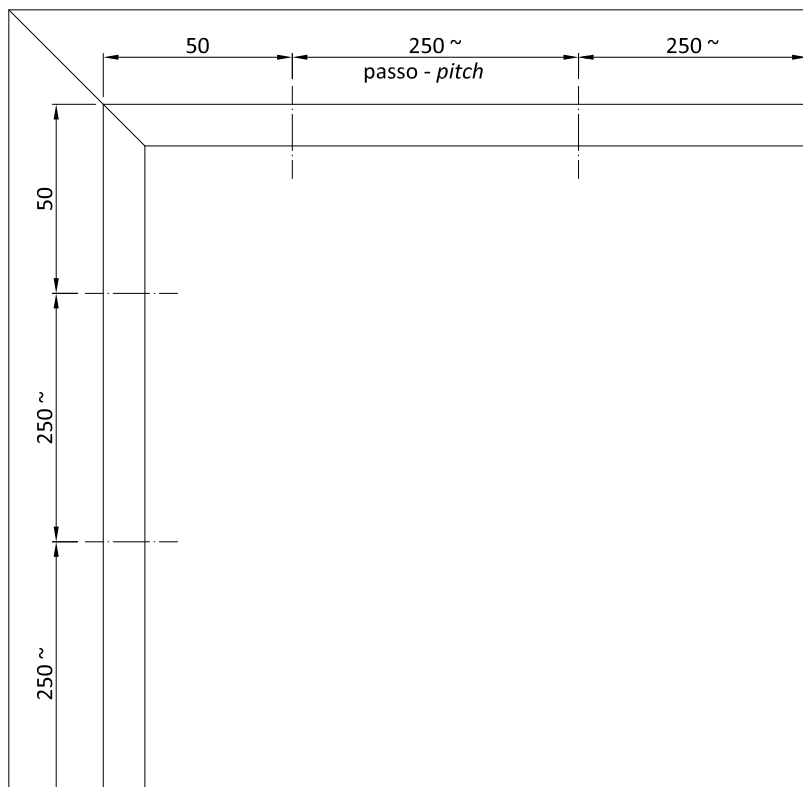

Passo clips fissaggio fermavetri  
 Clip pitch for glazing beads securing

Fissaggio fermavetri PA2606-PA2607: vite CV1243(I) TPS 4.2x13 e boccola CV5012(I)  
Glazing bead fixing PA2606-PA2607: screw CV1243(I) TPS 4.2x13 and bushing CV5012(I)

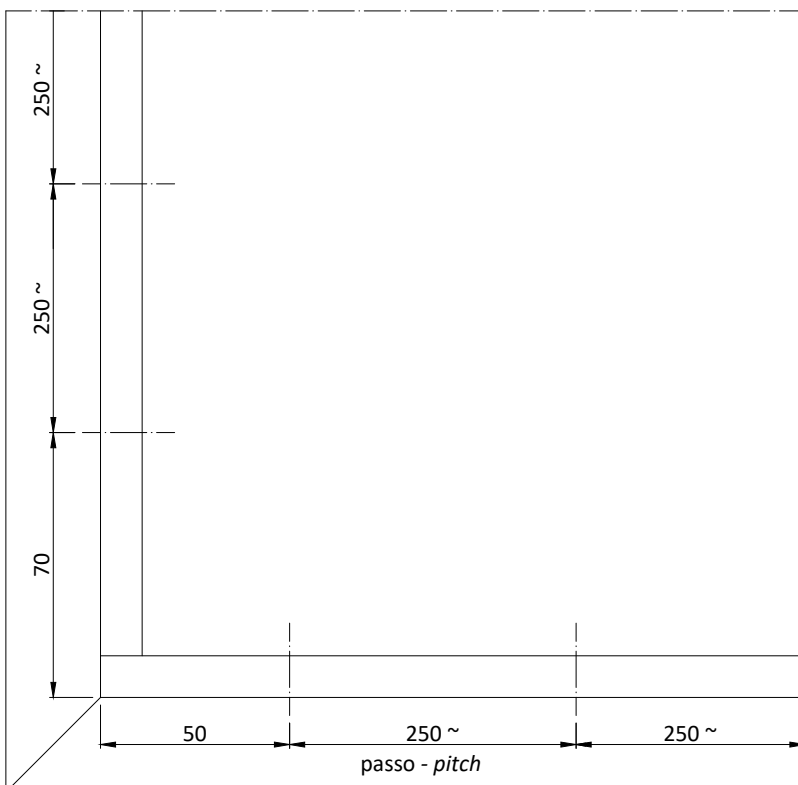
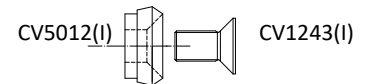
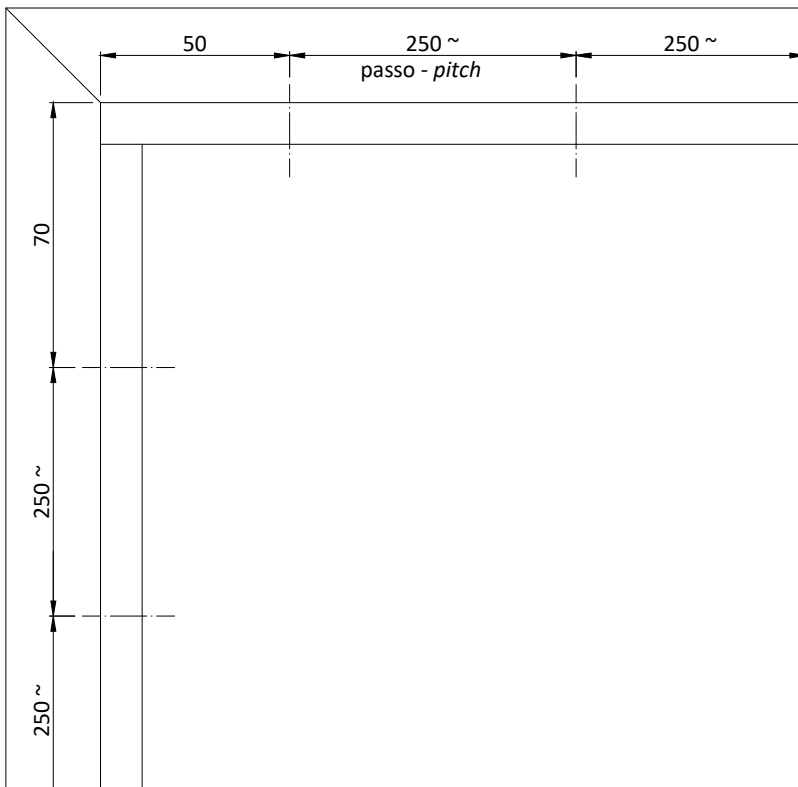

Passo vite e boccola fissaggio fermavetri  
Screw and bushing pitch for glazing beads fixing

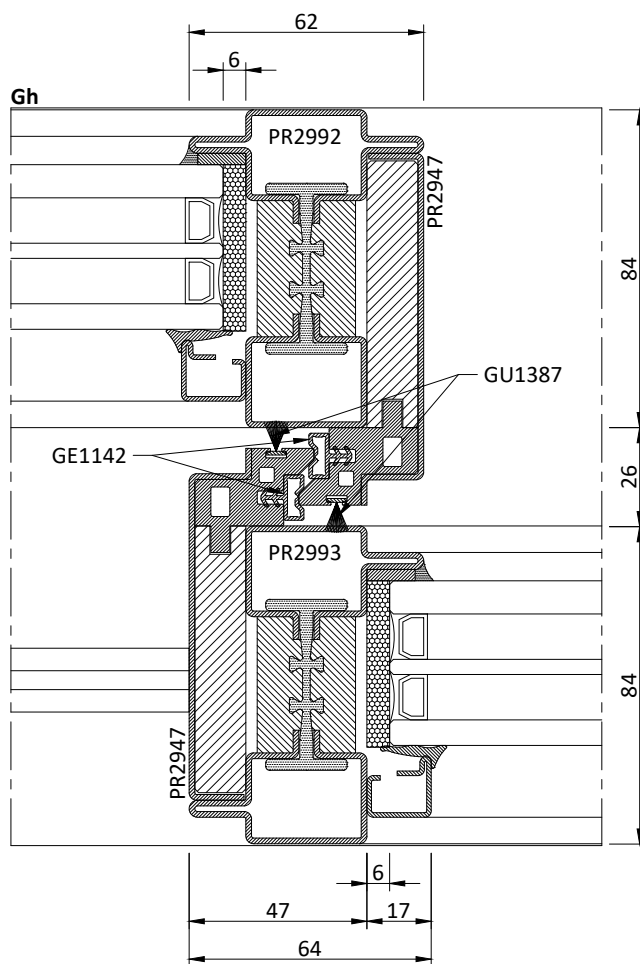
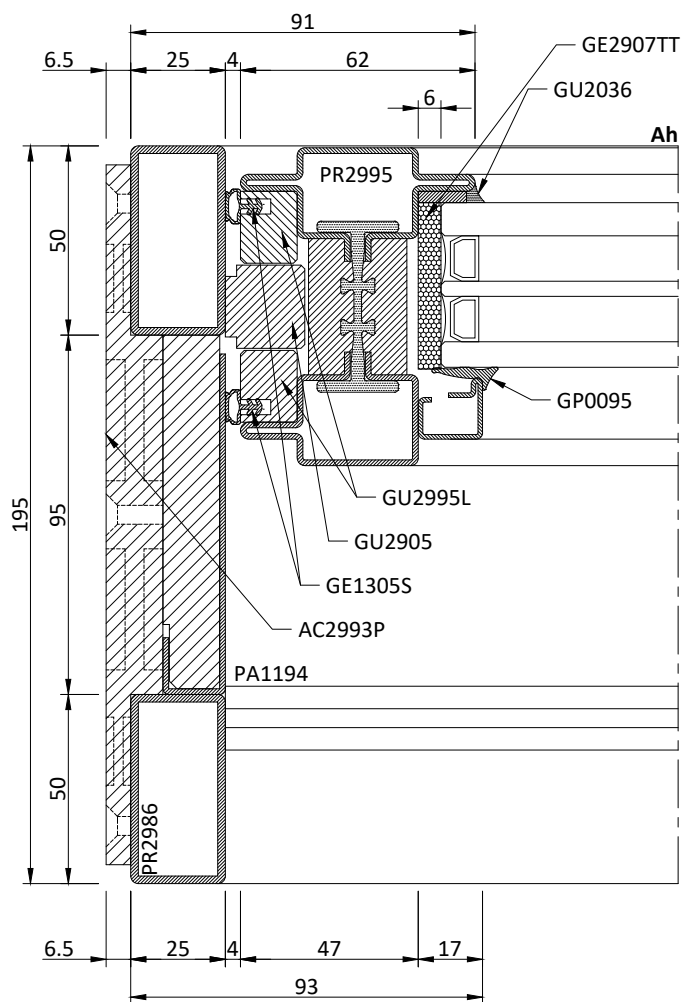
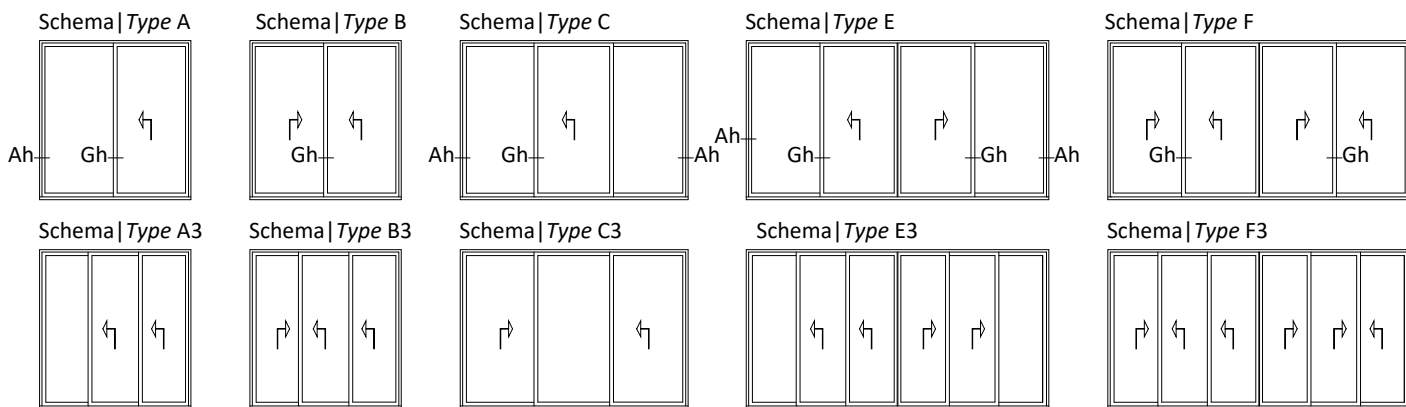

Schema | Type A

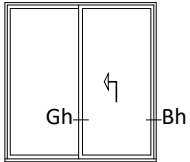

Schema | Type B

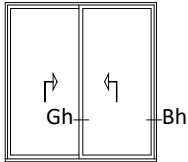

Schema | Type C

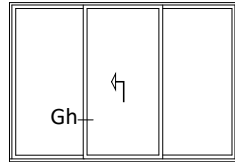

Schema | Type E

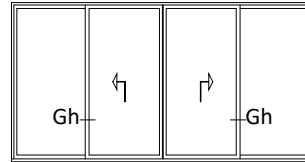

Schema | Type F

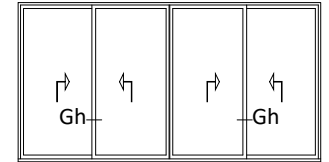

Schema | Type A3

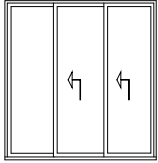

Schema | Type B3

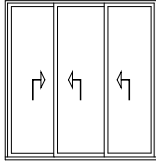

Schema | Type C3

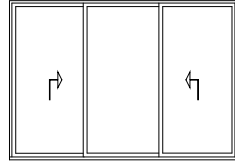

Schema | Type E3

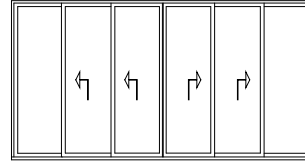

Schema | Type F3

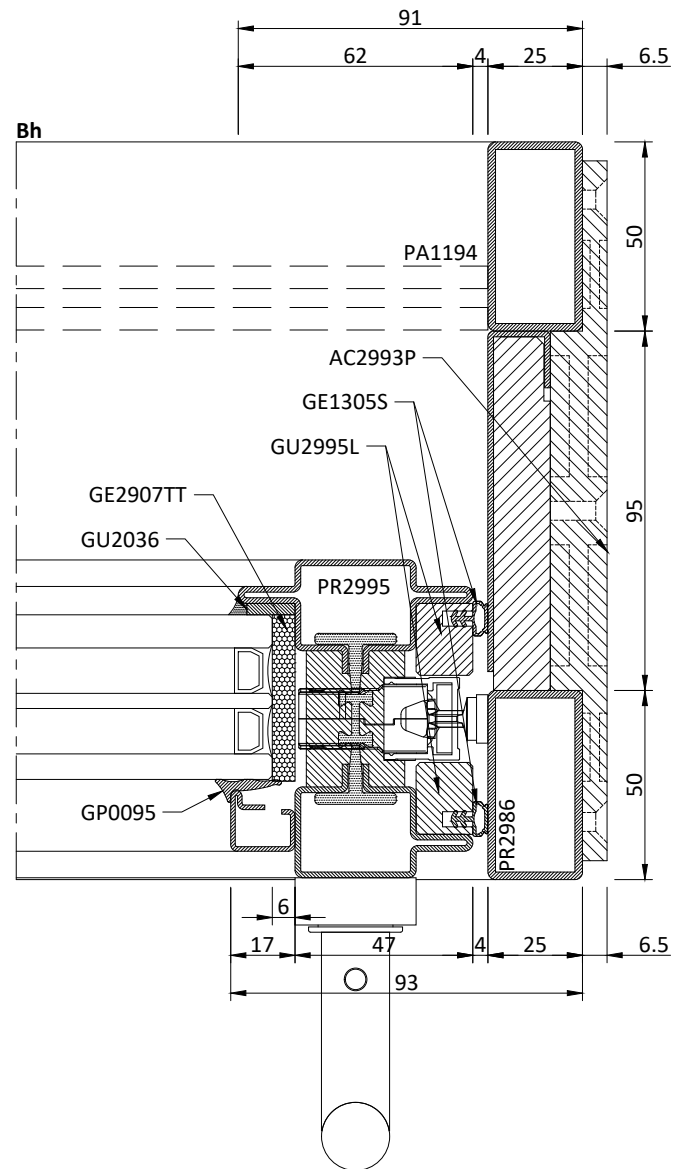
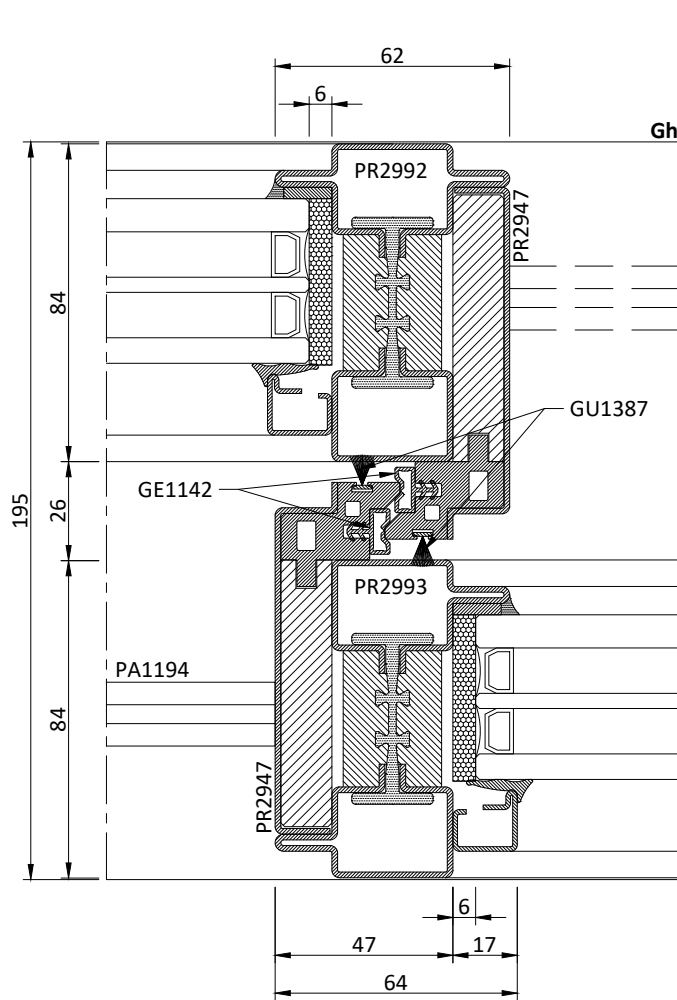
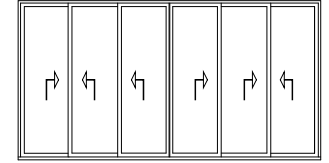



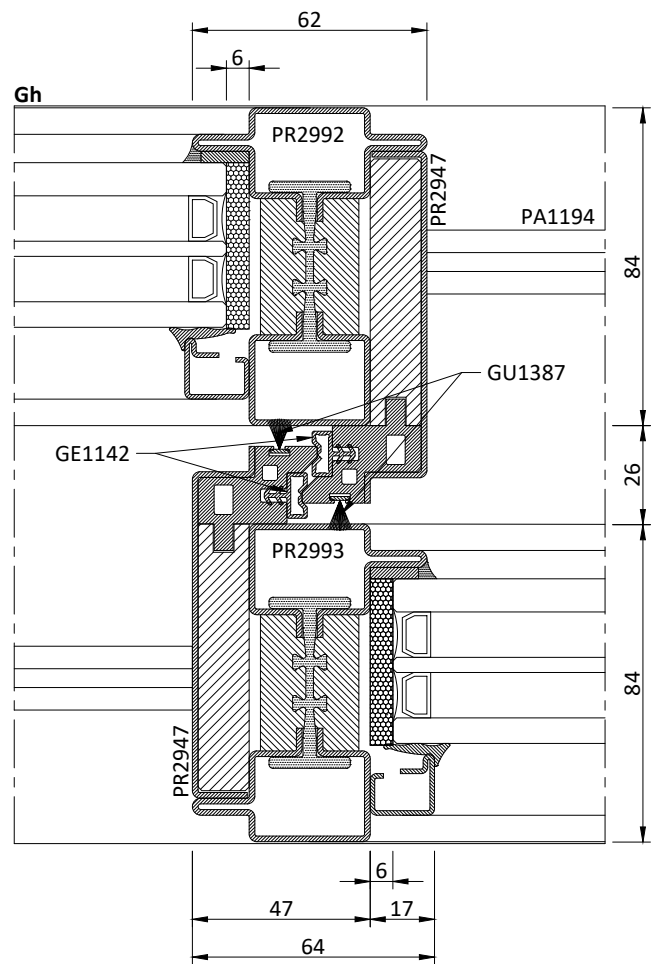
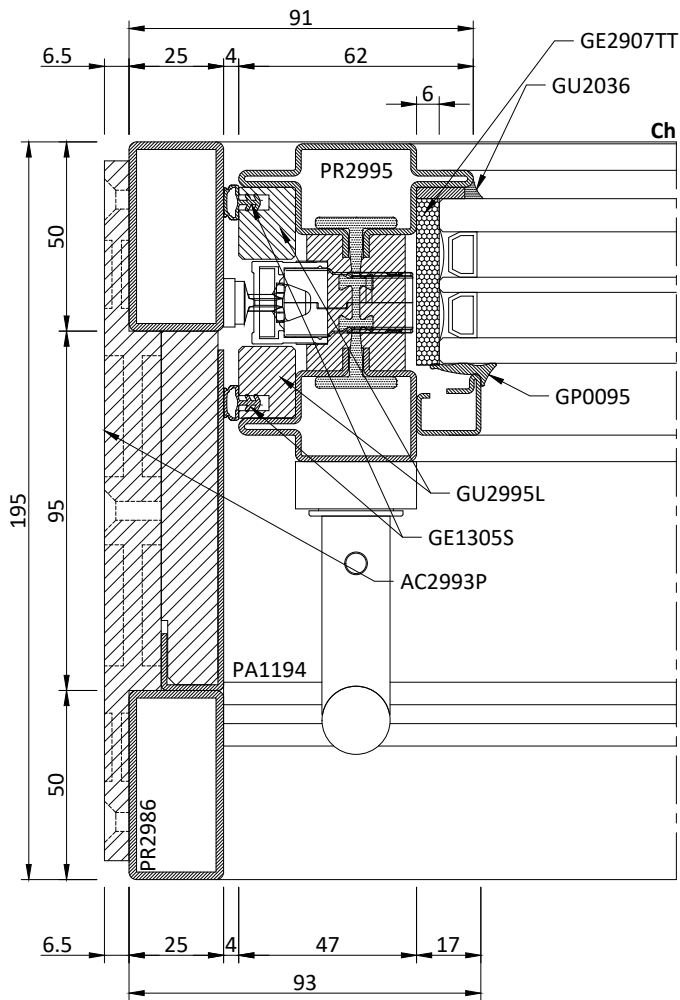
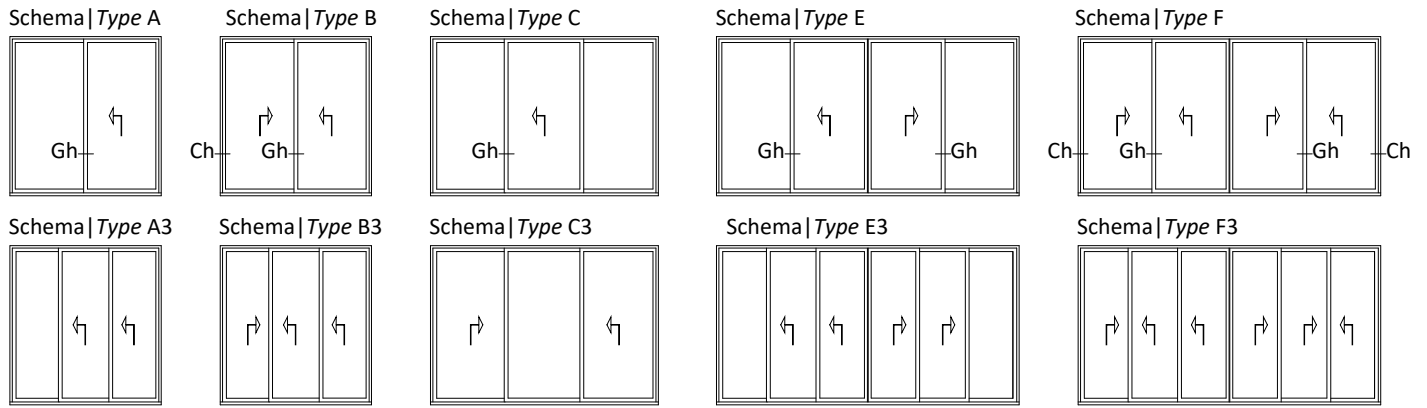

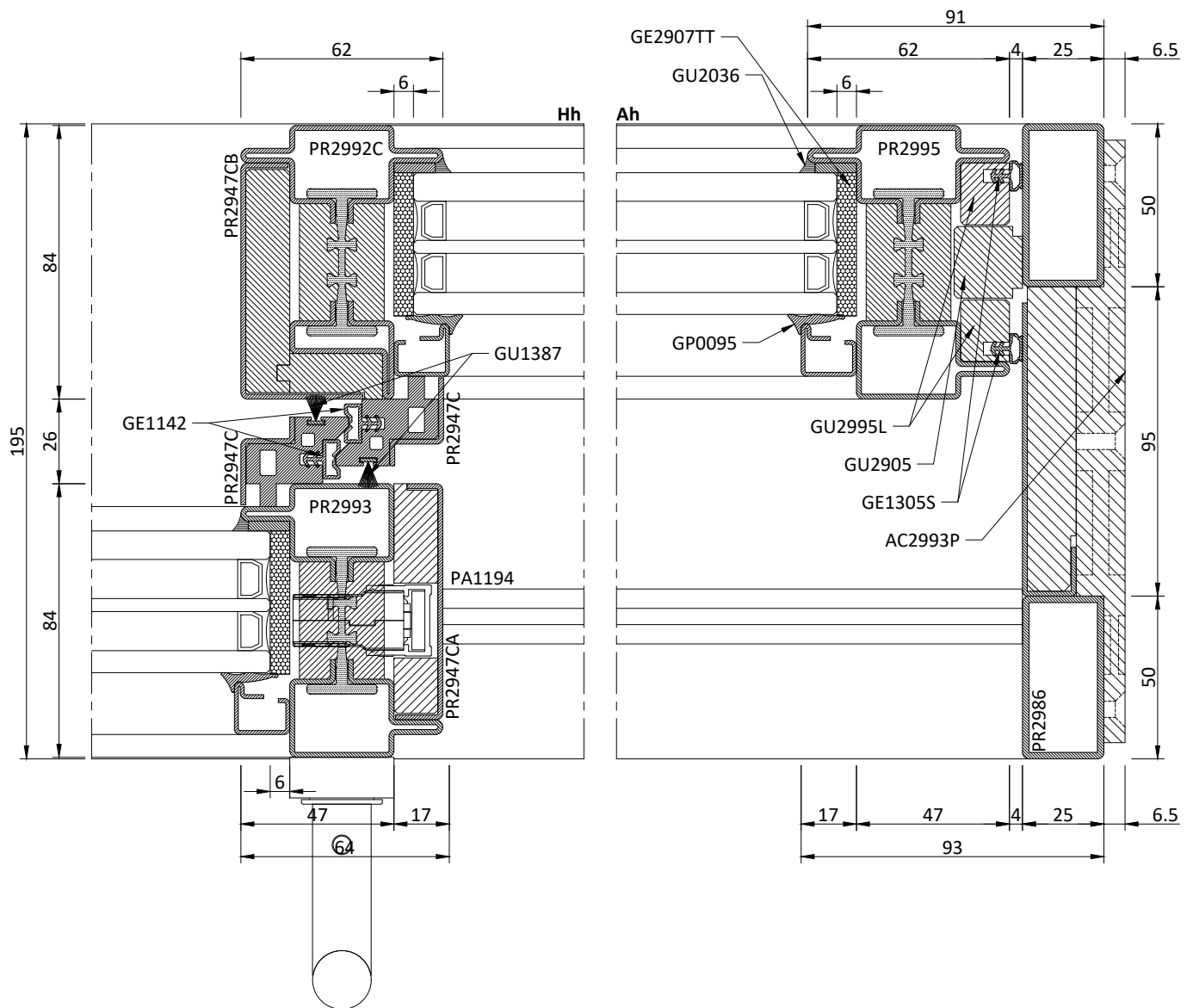
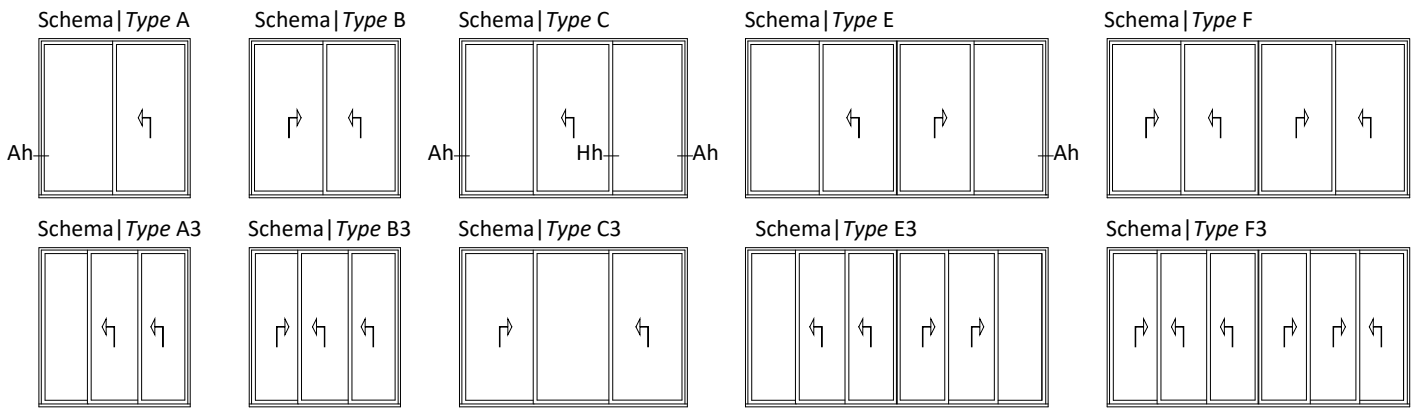

Schema | Type A

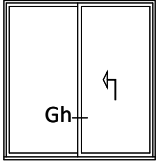

Schema | Type B

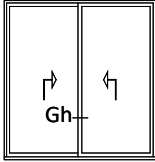

Schema | Type C

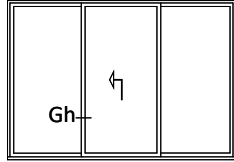

Schema | Type E

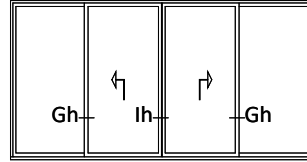

Schema | Type F

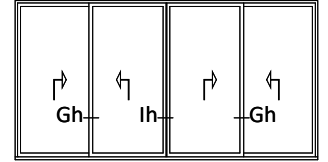

Schema | Type A3

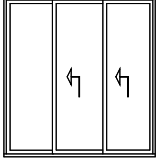

Schema | Type B3

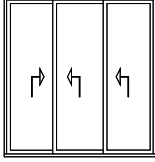

Schema | Type C3

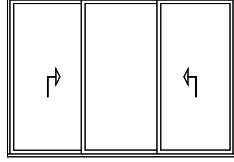

Schema | Type E3

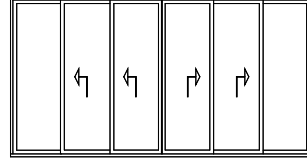

Schema | Type F3

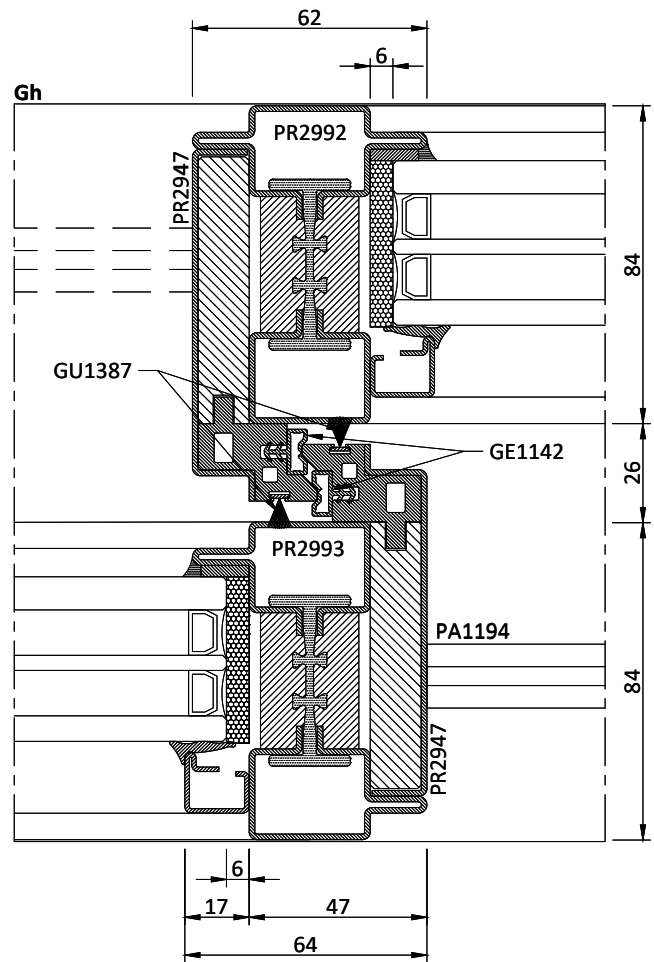
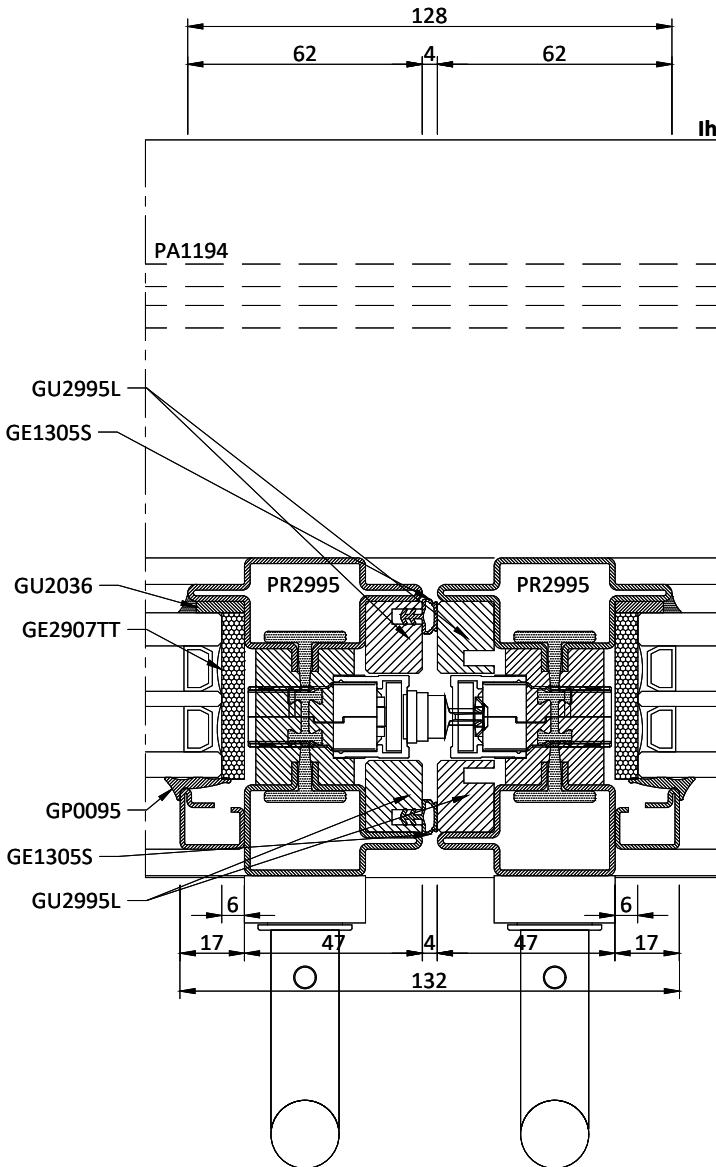
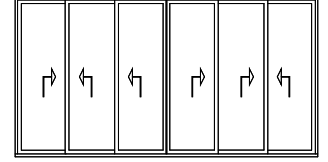

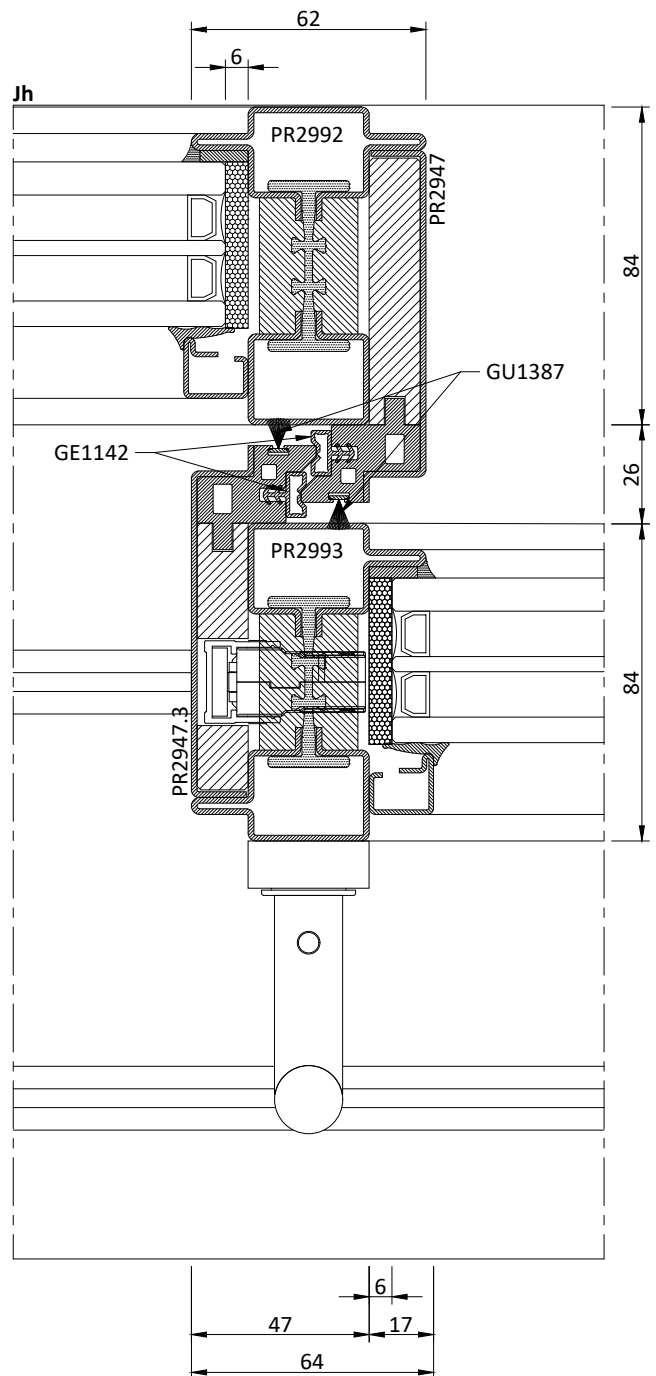
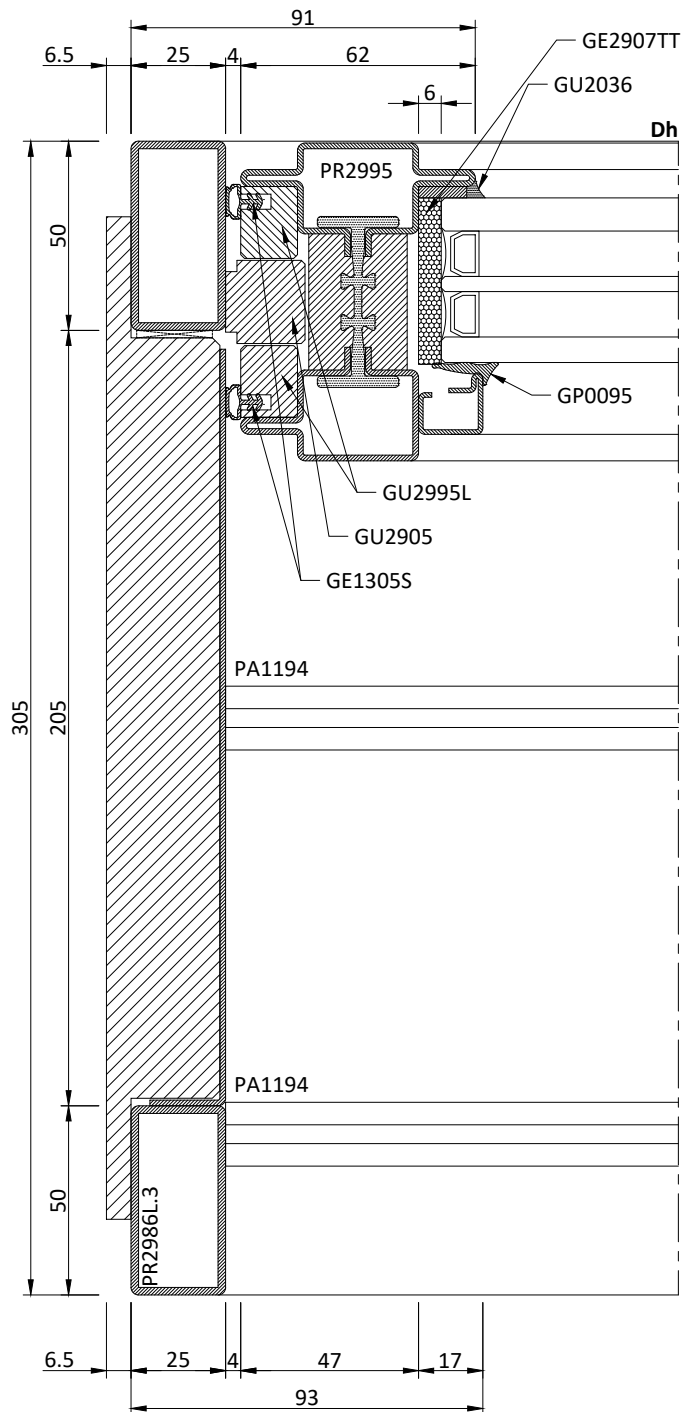
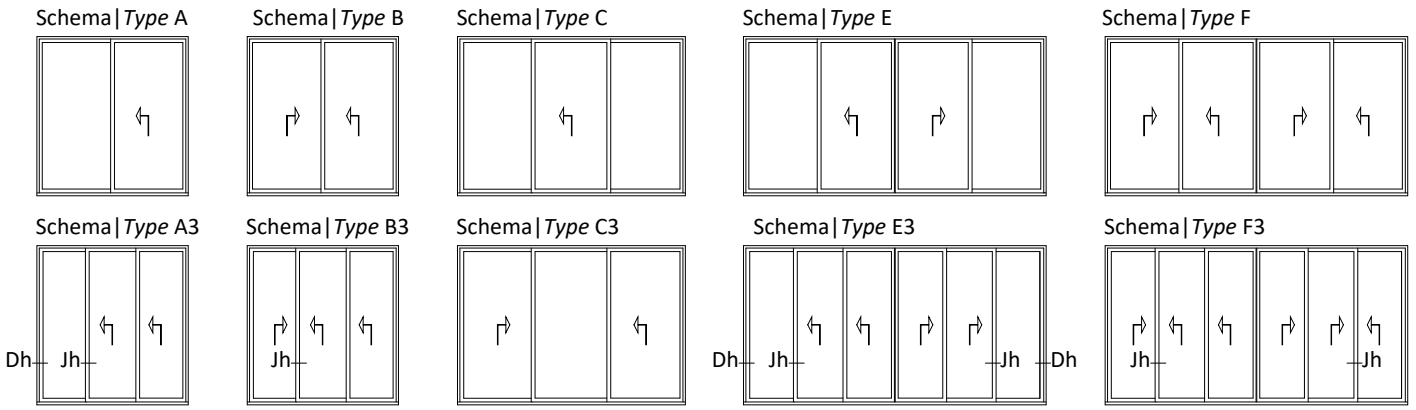

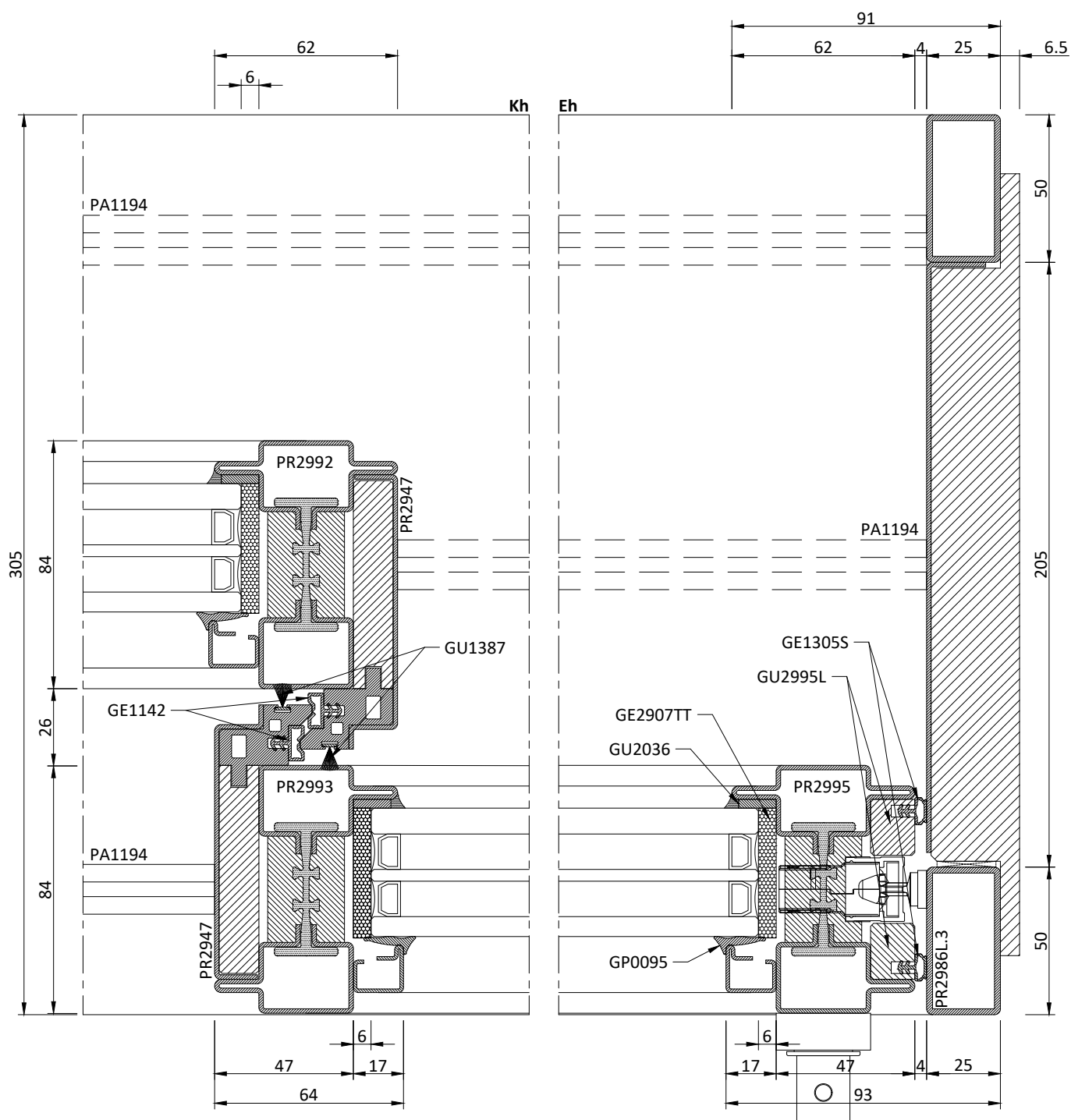
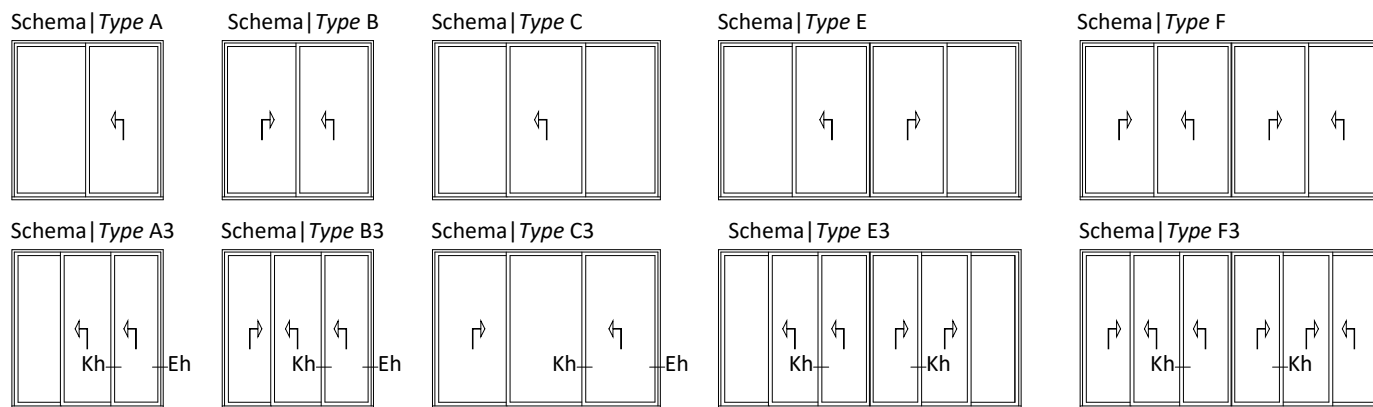

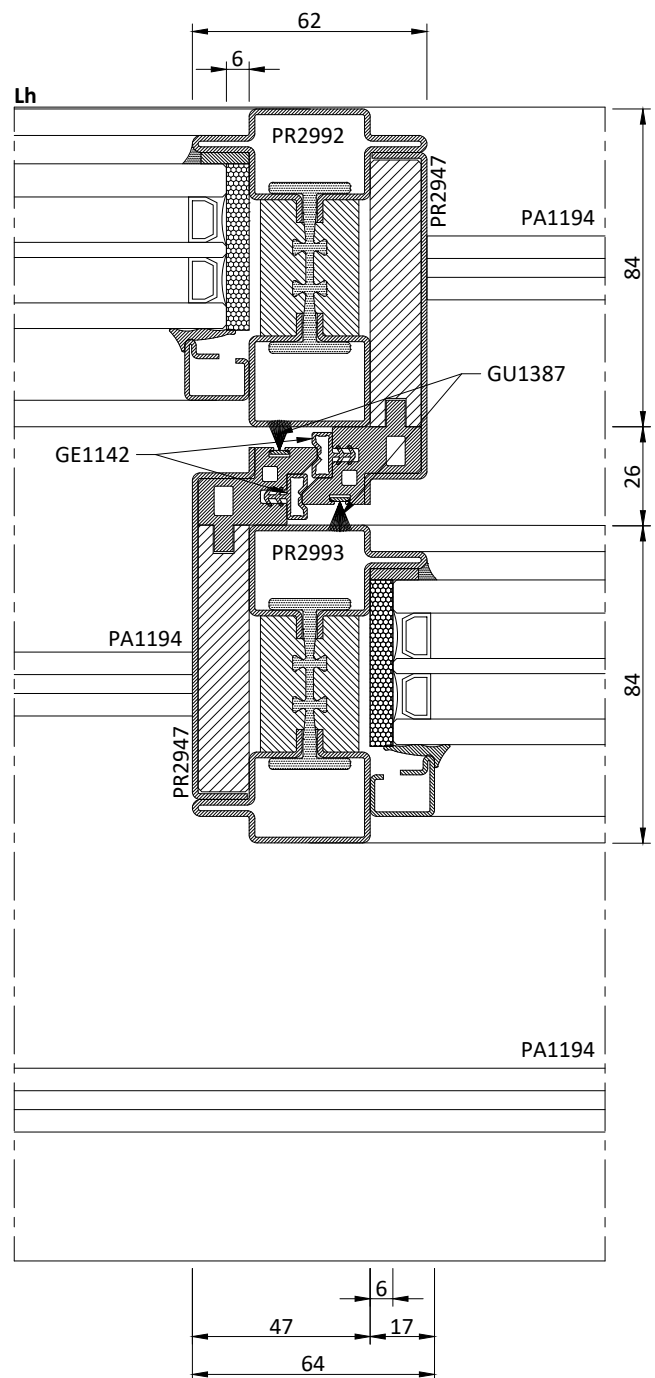
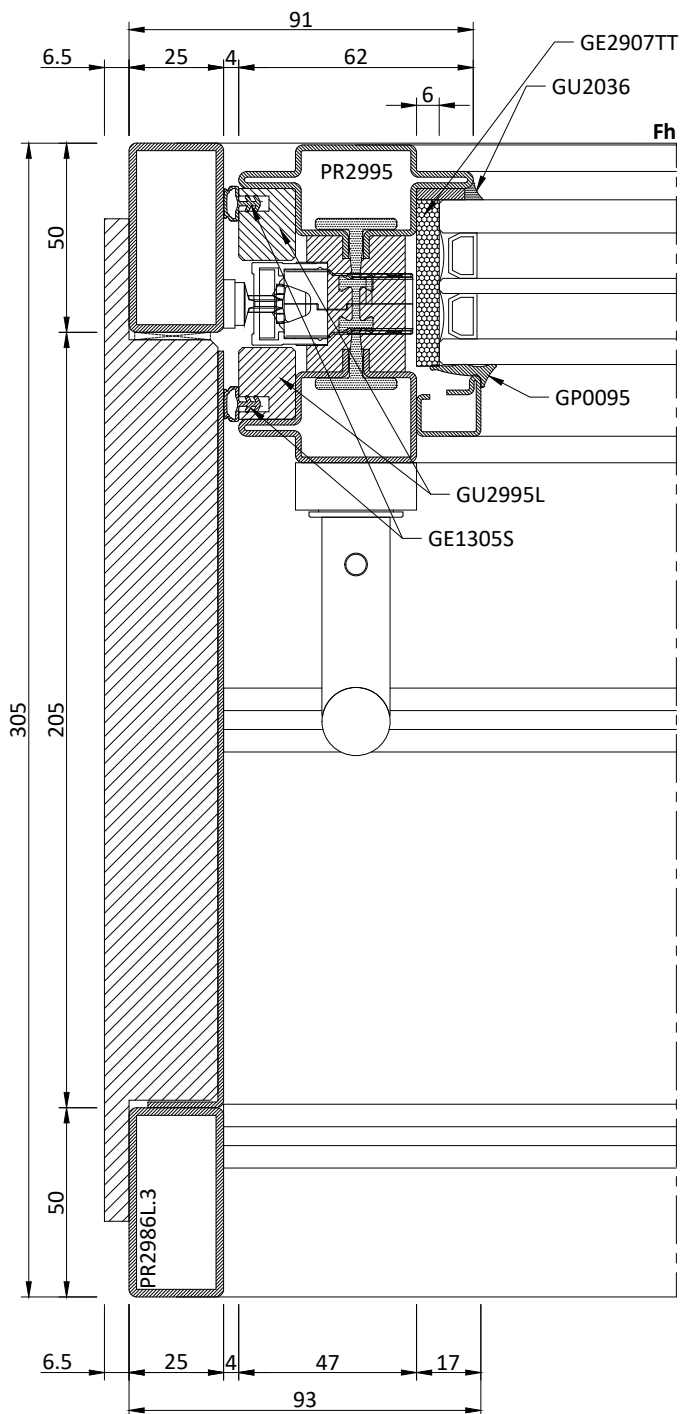
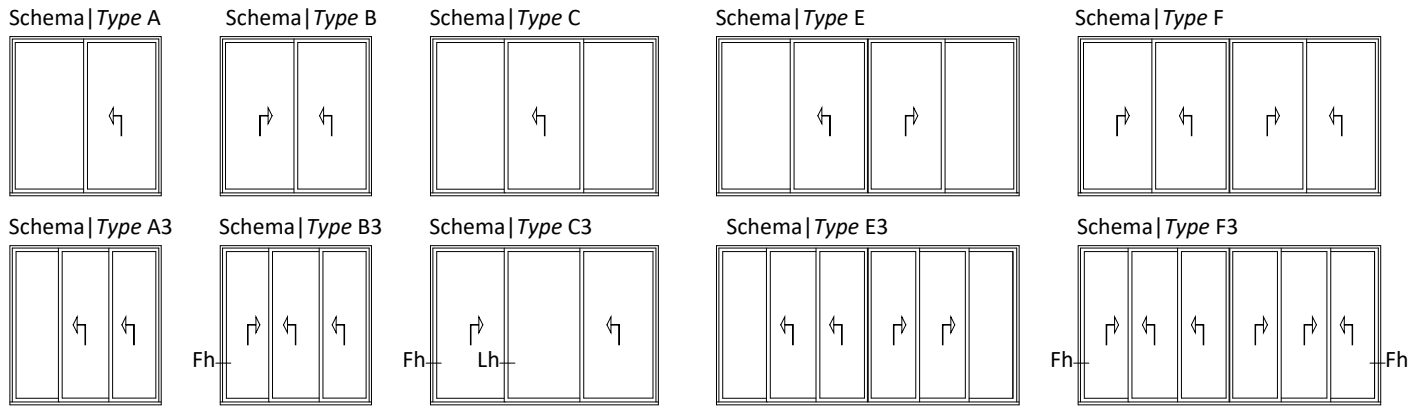

Schema | Type A

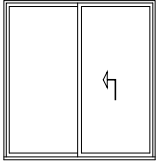

Schema | Type B

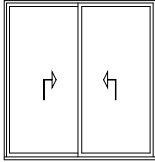

Schema | Type C

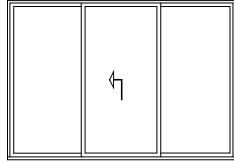

Schema | Type E

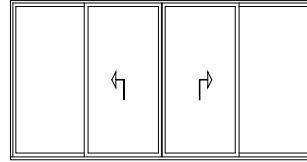

Schema | Type F

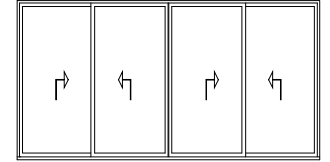

Schema | Type A3

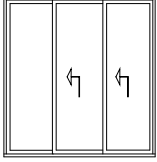

Schema | Type B3

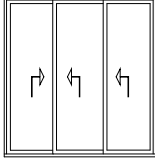

Schema | Type C3

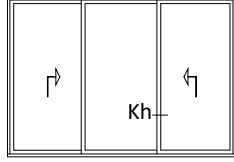

Schema | Type E3

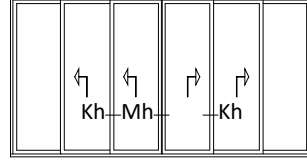

Schema | Type F3

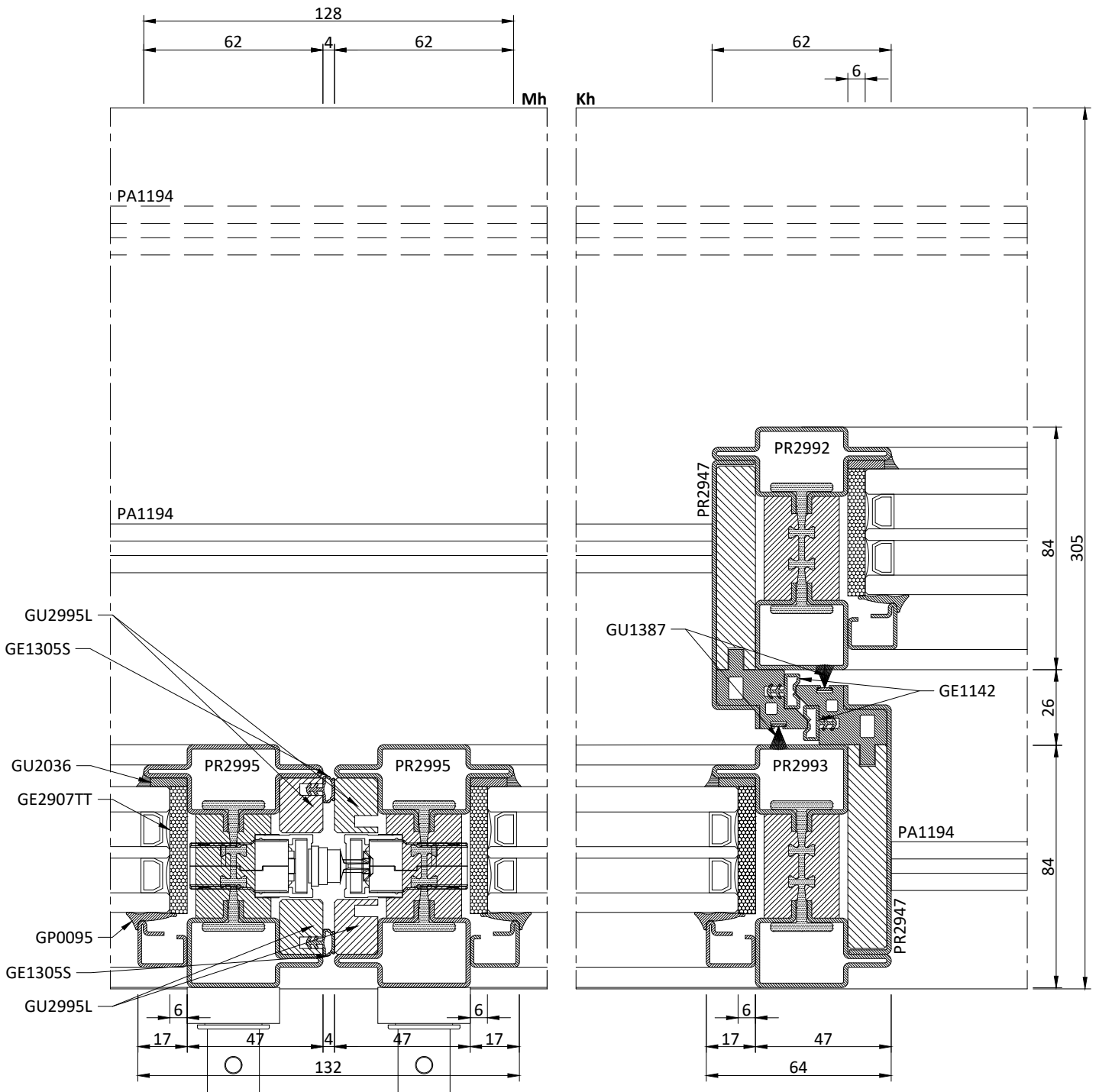
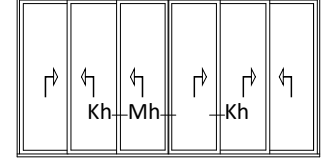

Schema | Type A

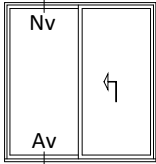

Schema | Type B

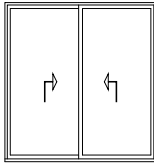

Schema | Type C

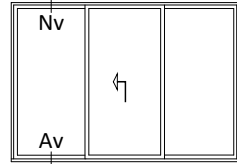

Schema | Type E

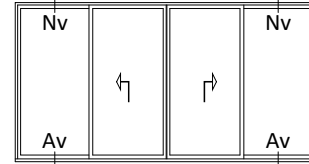

Schema | Type F

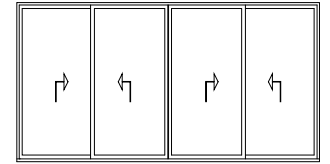

Schema | Type A3

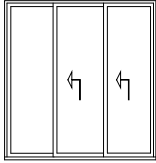

Schema | Type B3

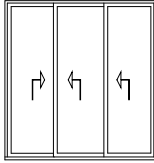

Schema | Type C3

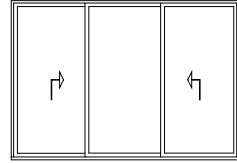

Schema | Type E3

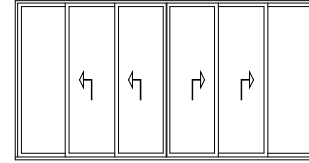

Schema | Type F3

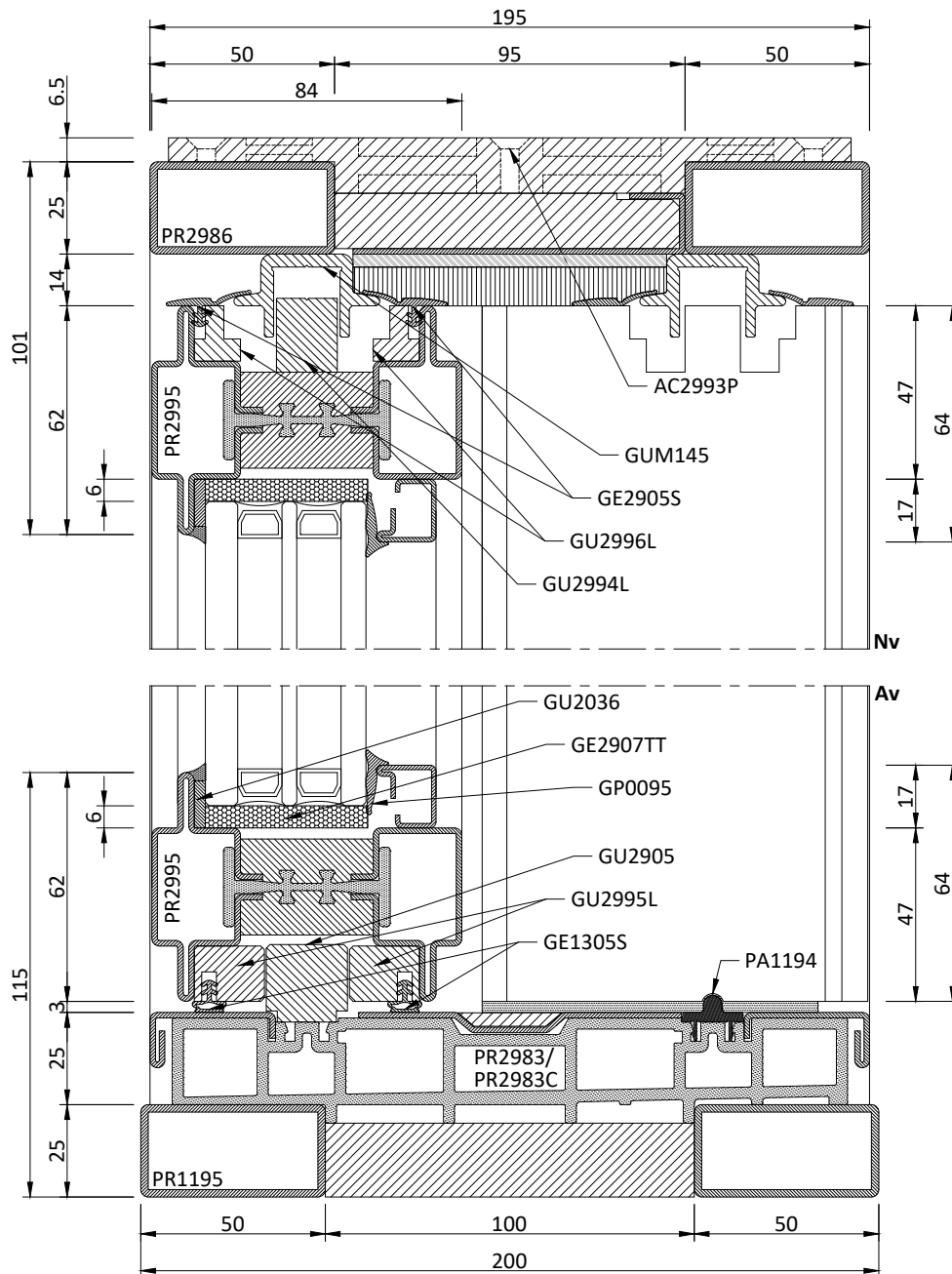
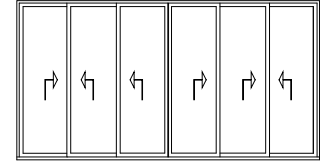



Schema | Type A

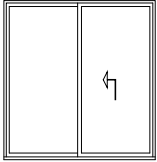

Schema | Type B

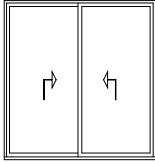

Schema | Type C

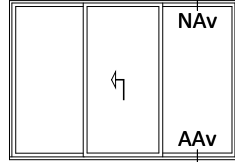

Schema | Type E

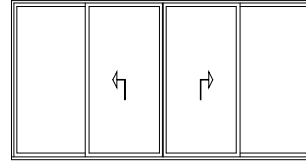

Schema | Type F

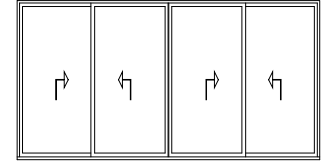

Schema | Type A3

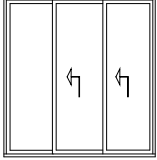

Schema | Type B3

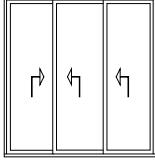

Schema | Type C3

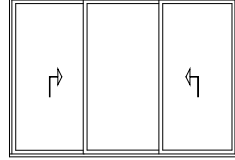

Schema | Type E3

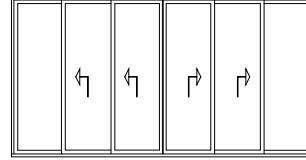

Schema | Type F3

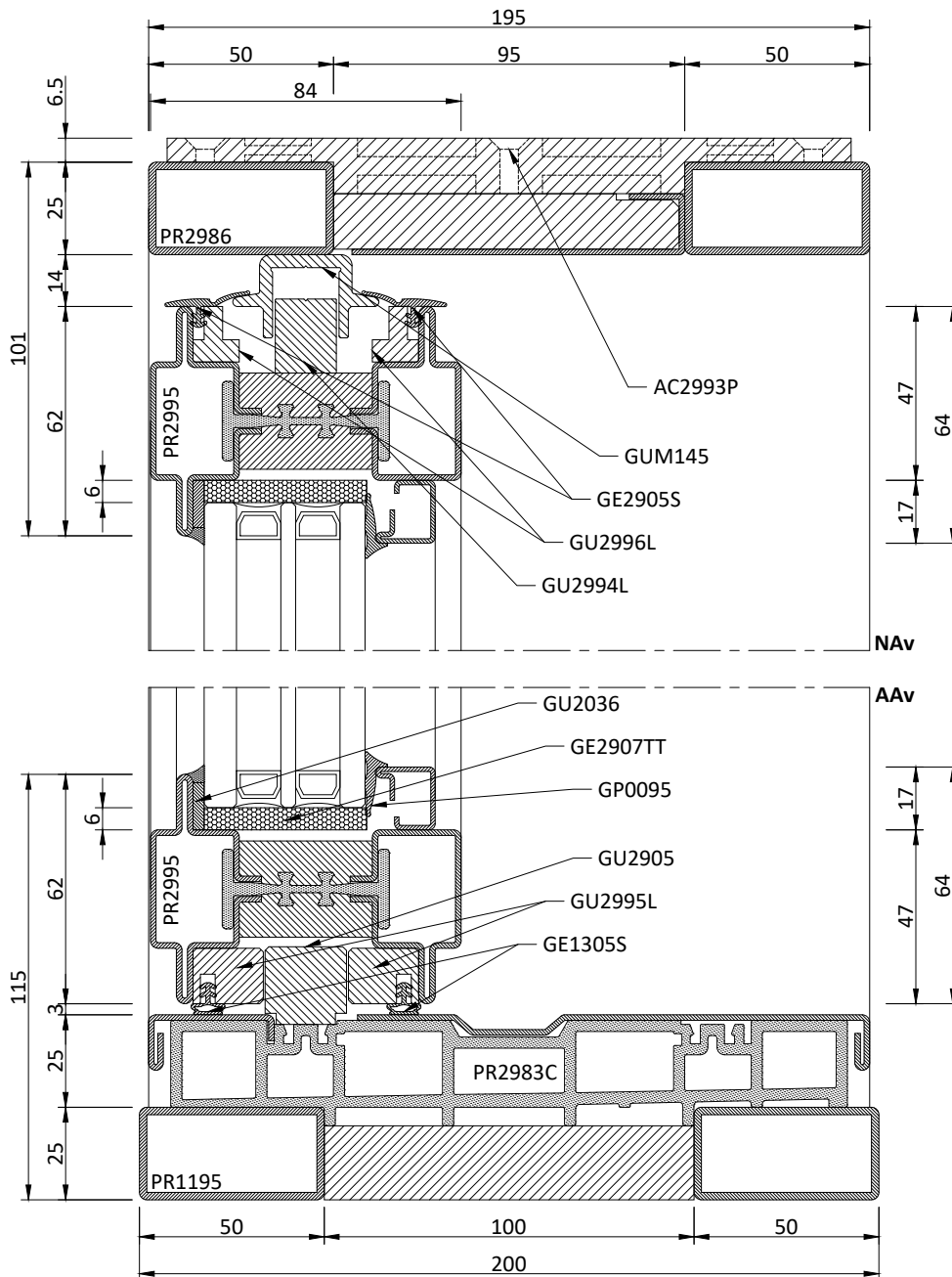
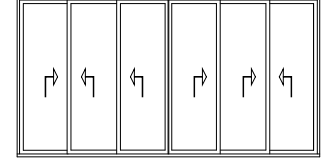

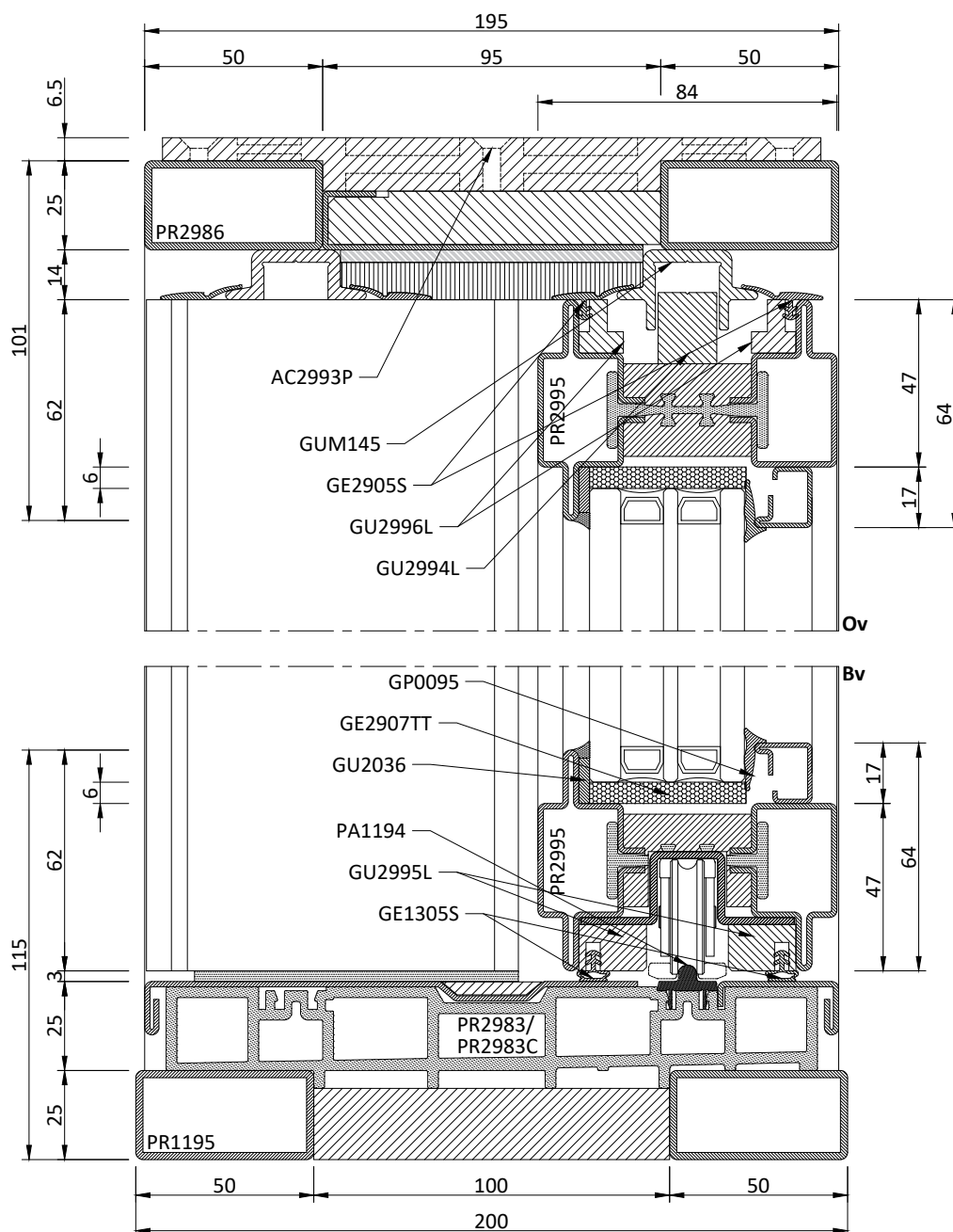
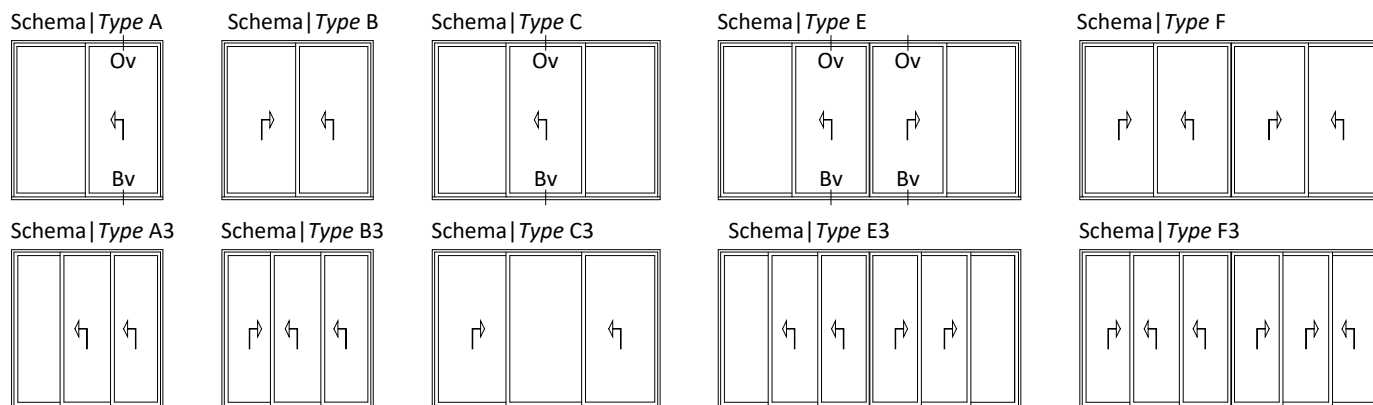

Schema | Type A

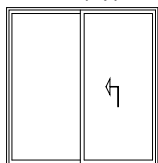

Schema | Type B

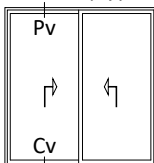

Schema | Type C

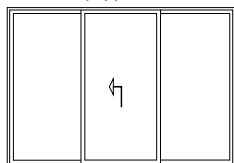

Schema | Type E

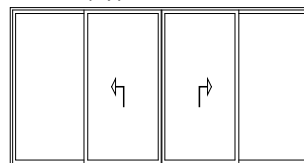

Schema | Type F

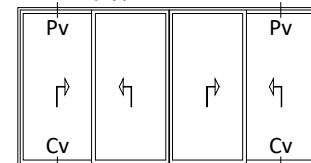

Schema | Type A3

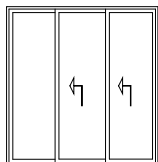

Schema | Type B3

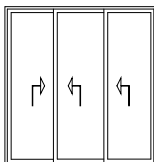

Schema | Type C3

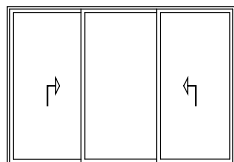

Schema | Type E3

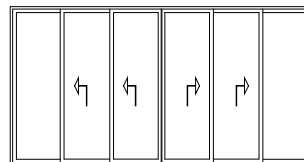

Schema | Type F3

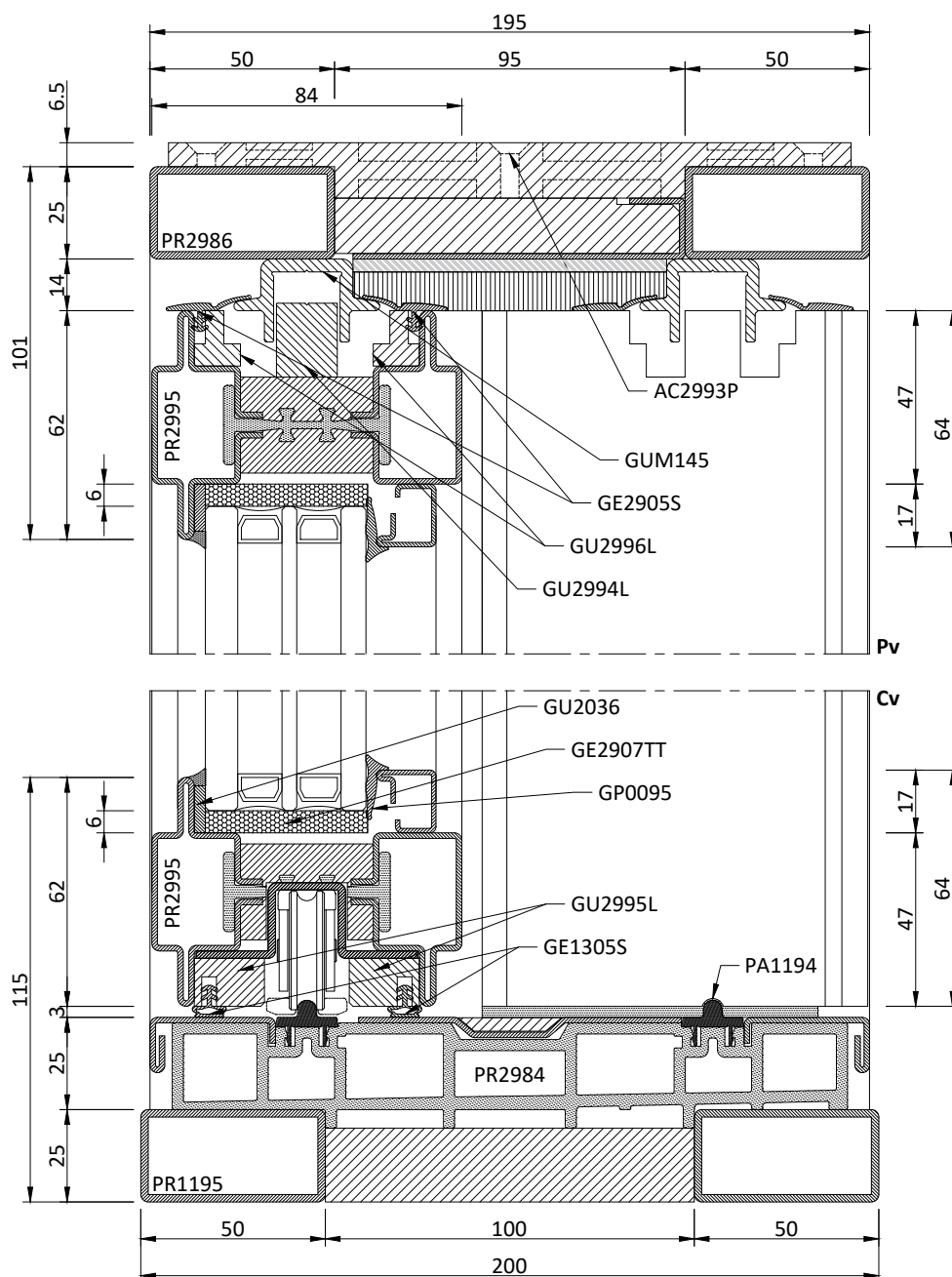
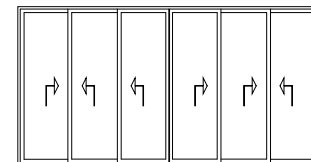

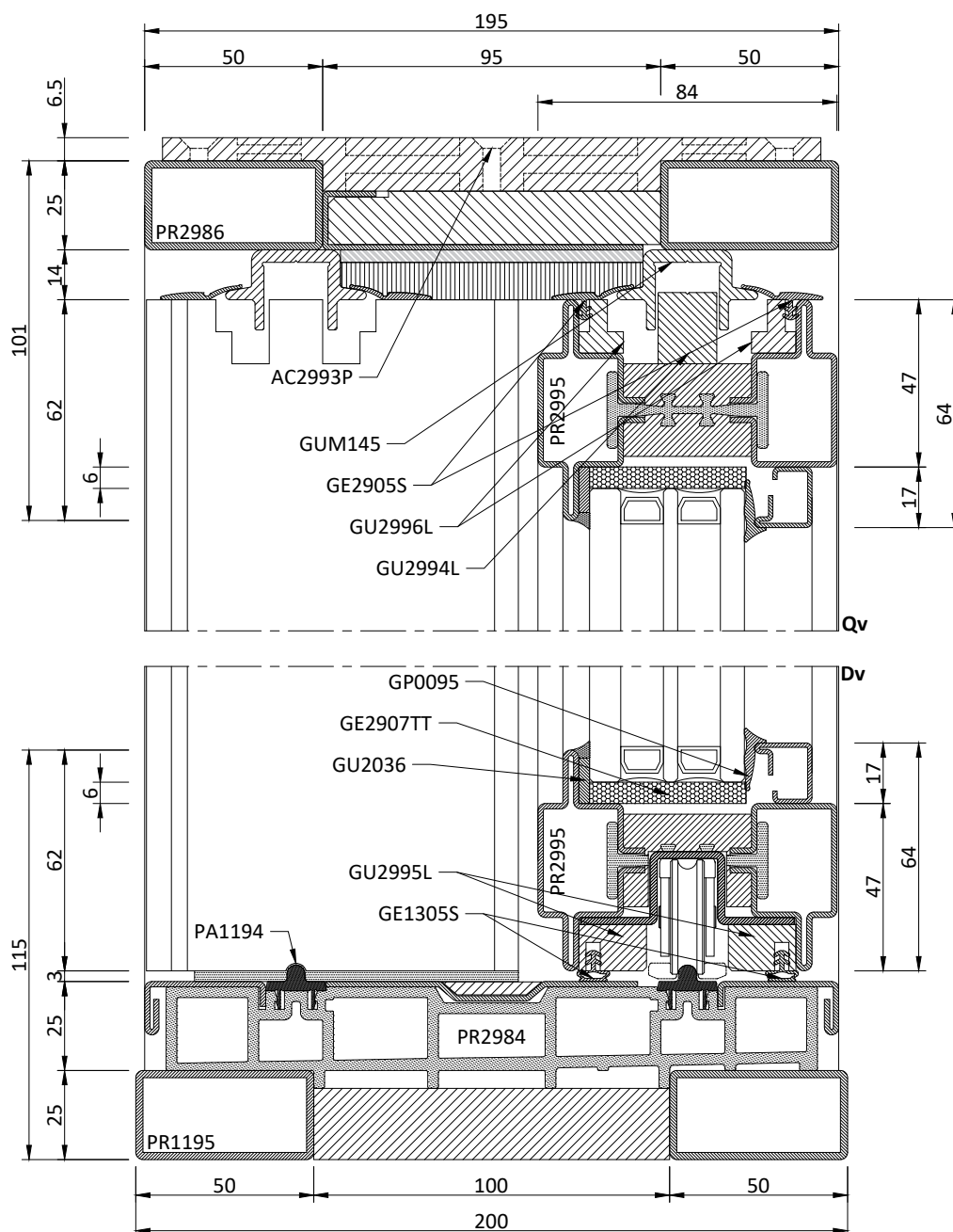
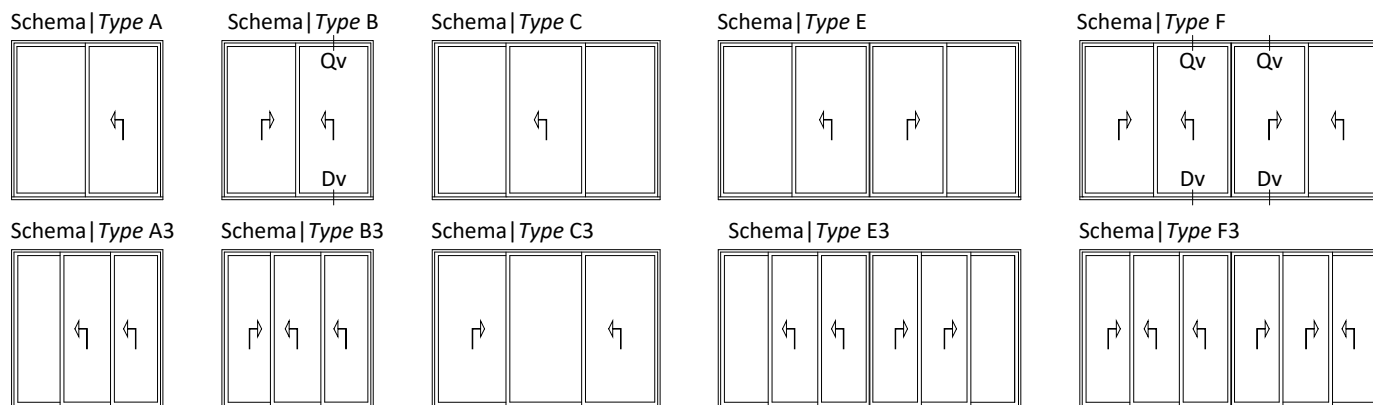

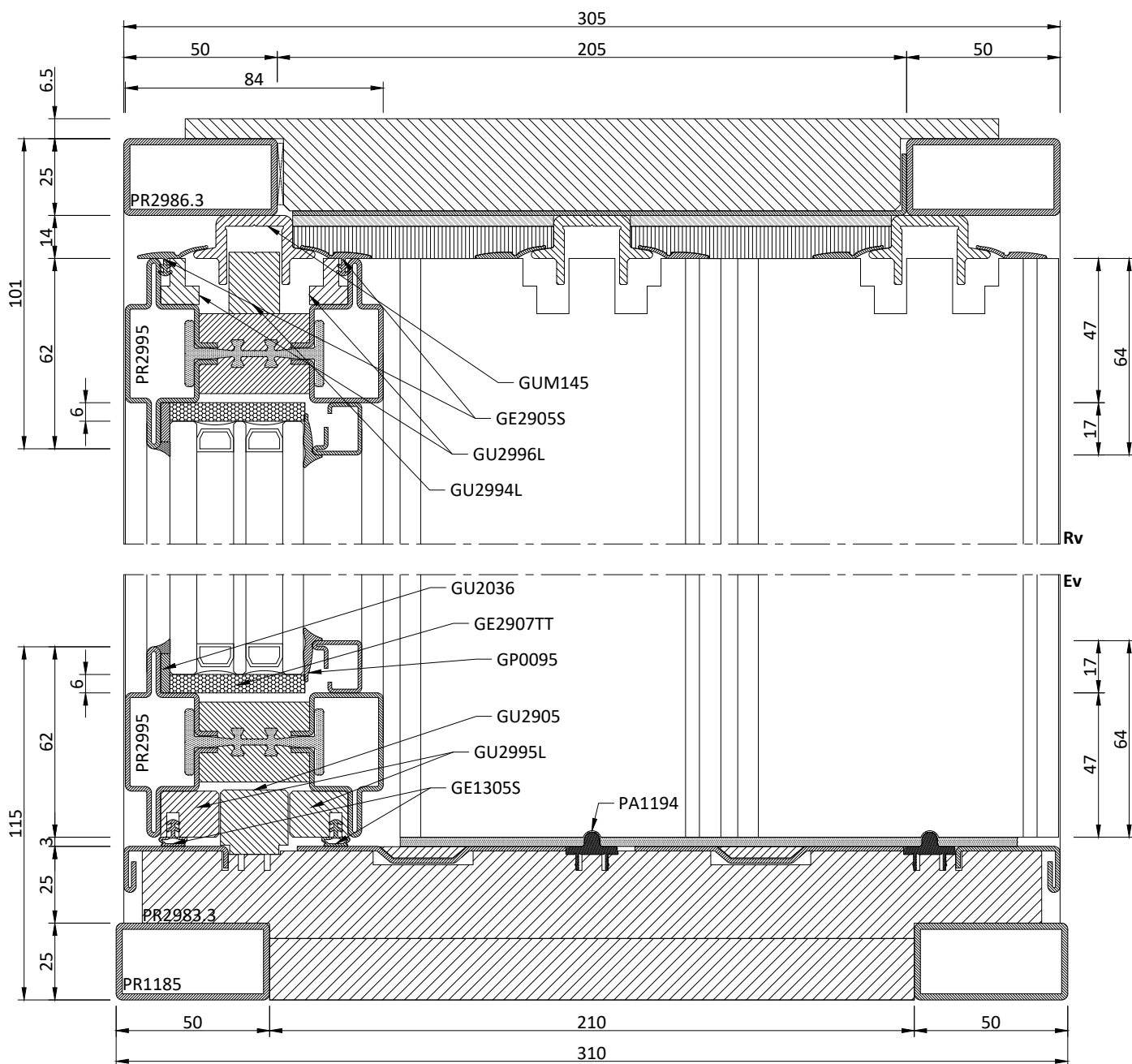
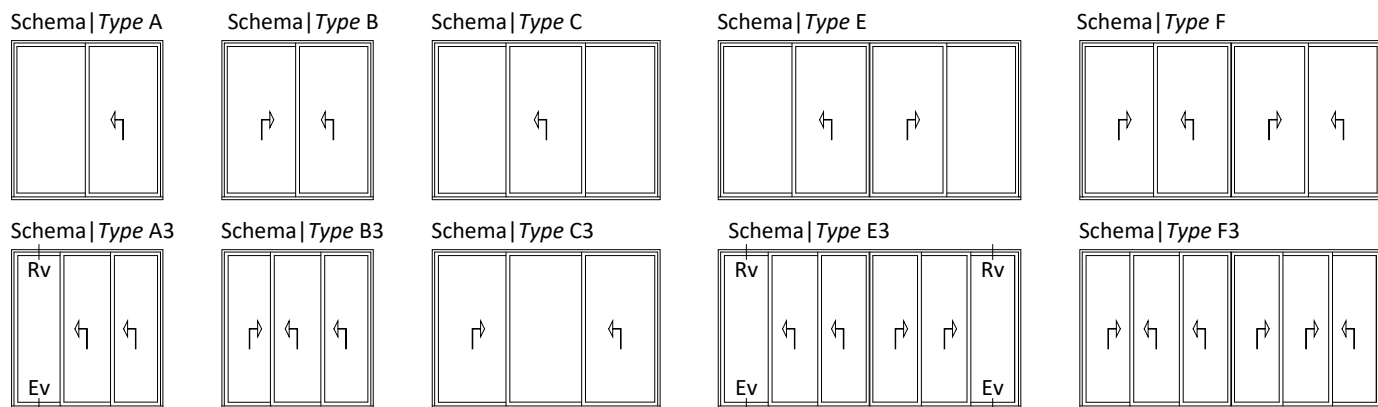

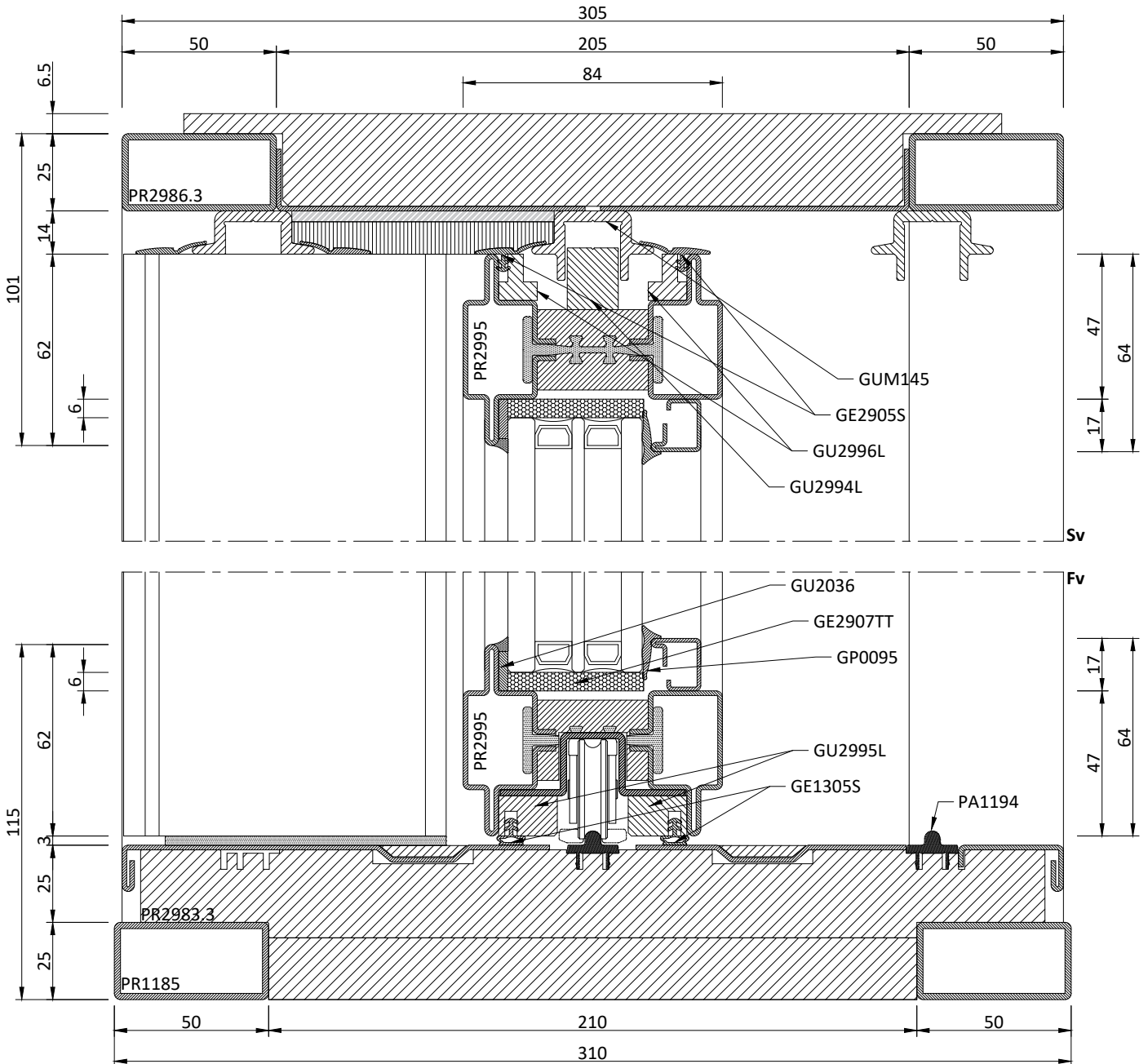
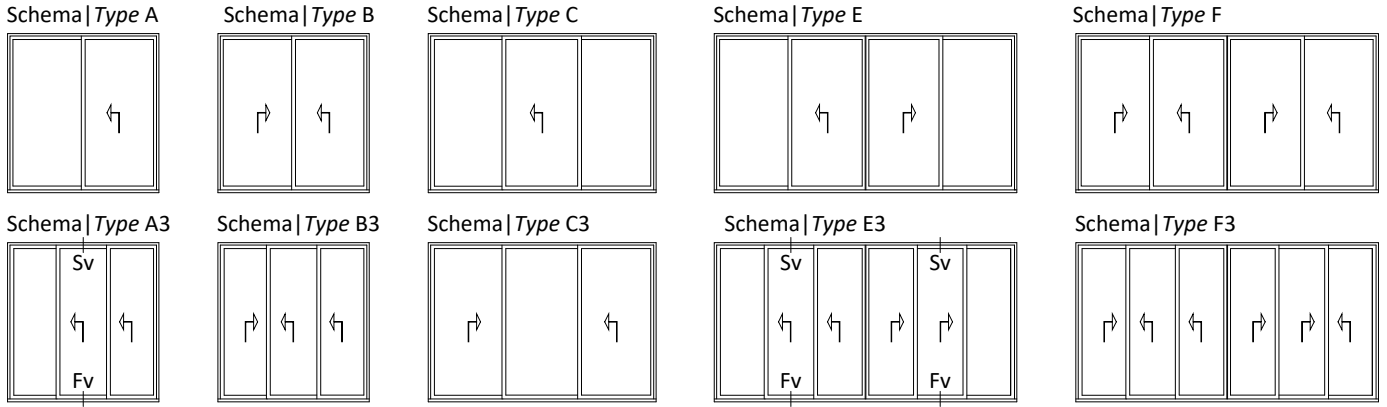

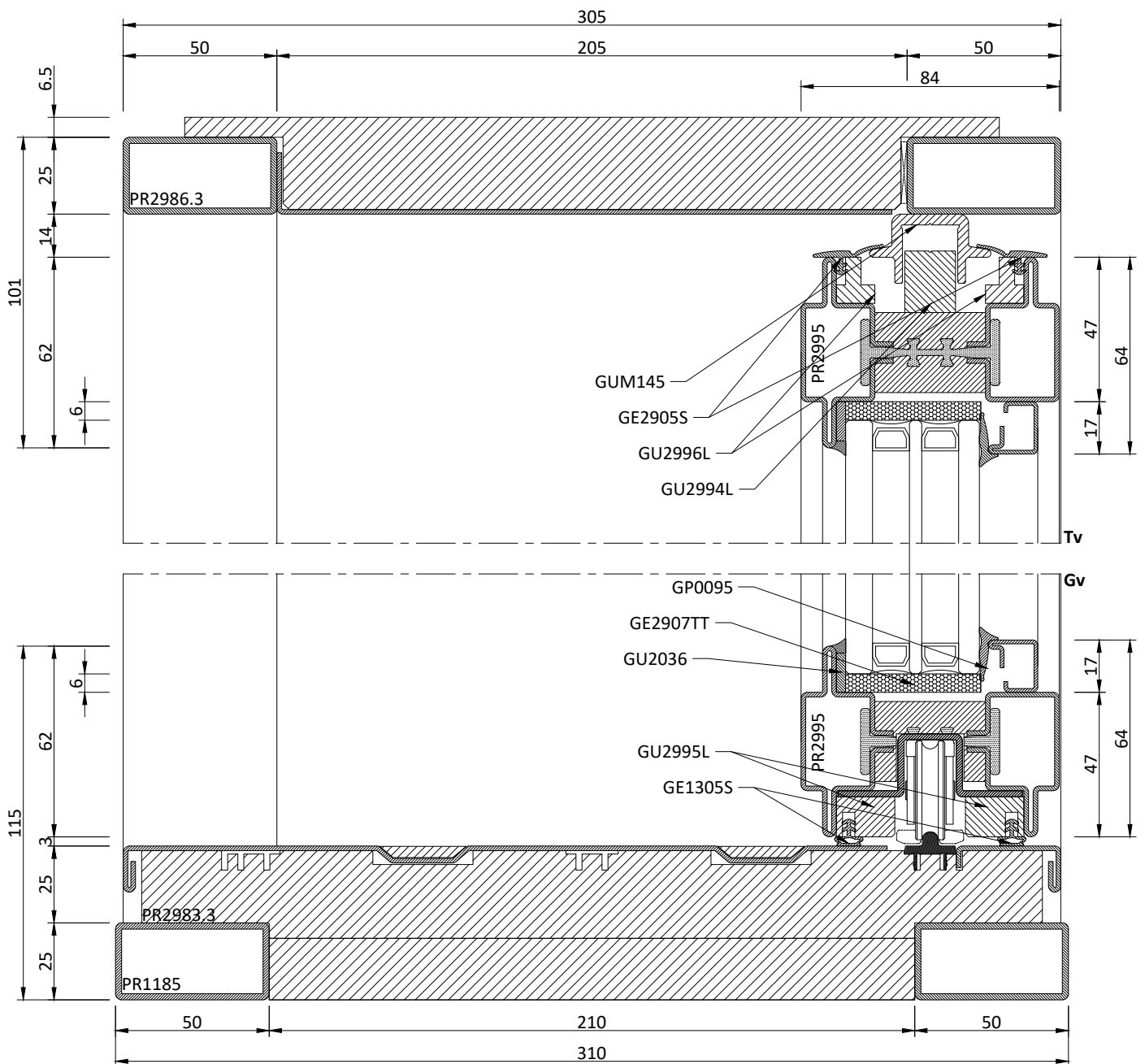
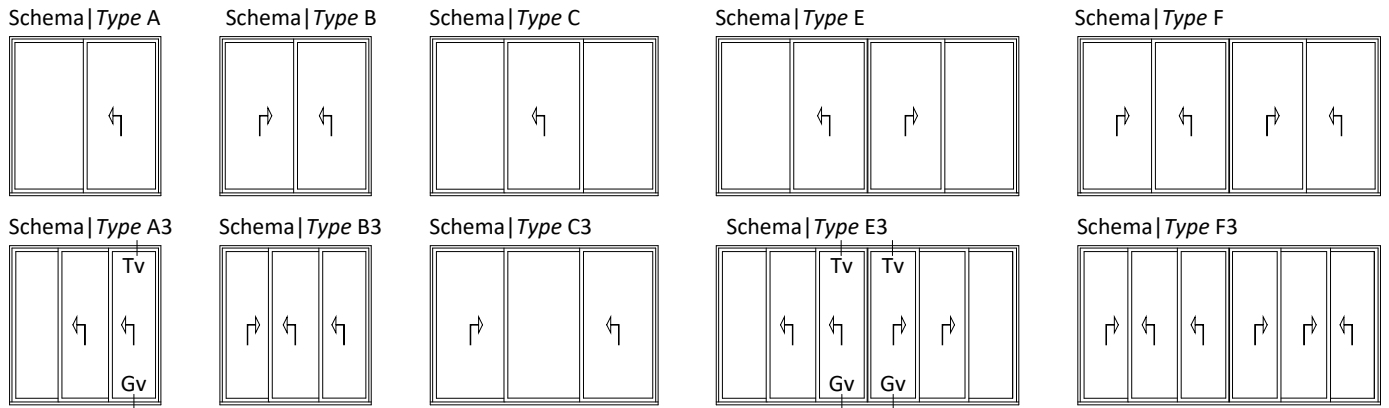

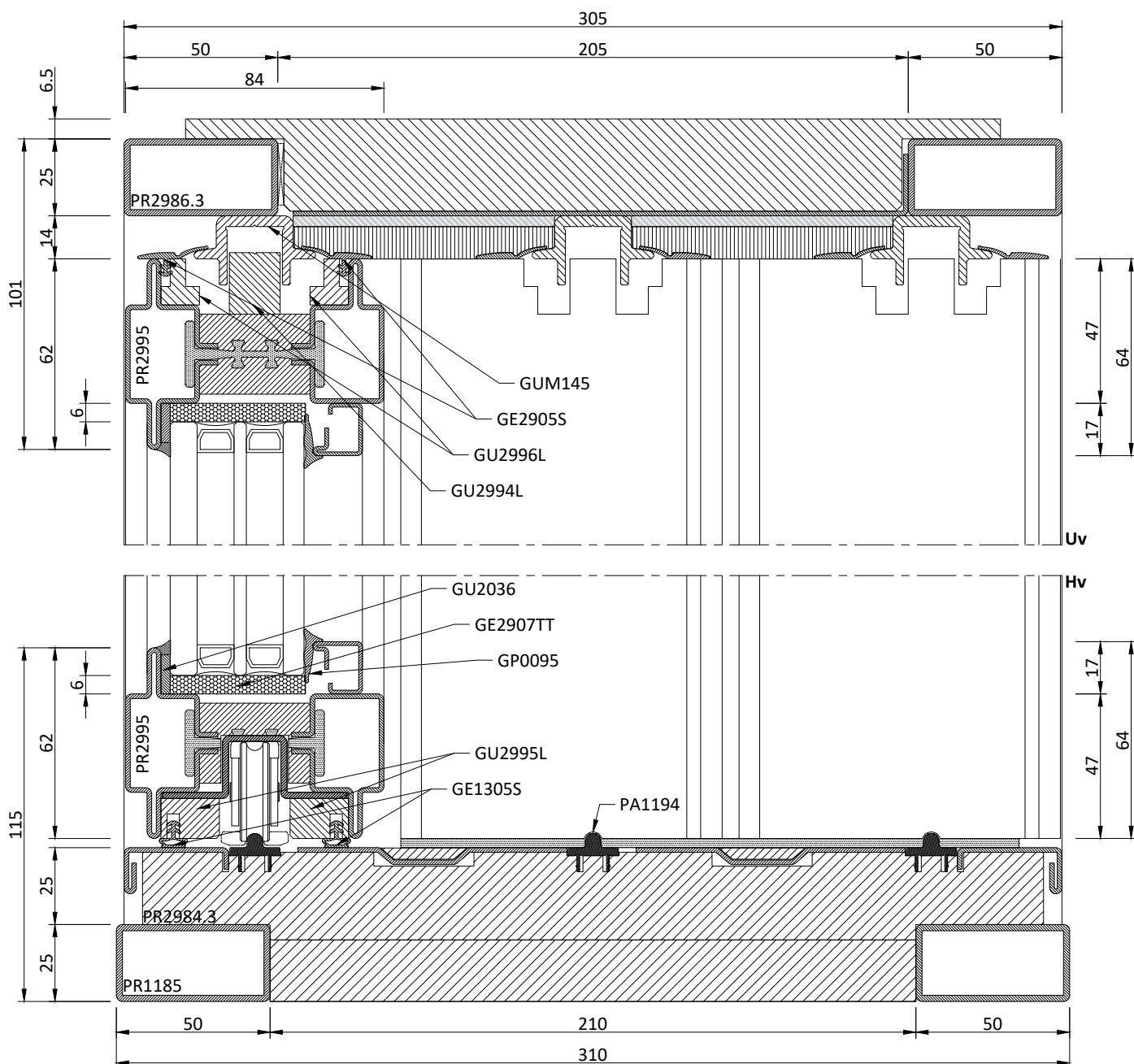
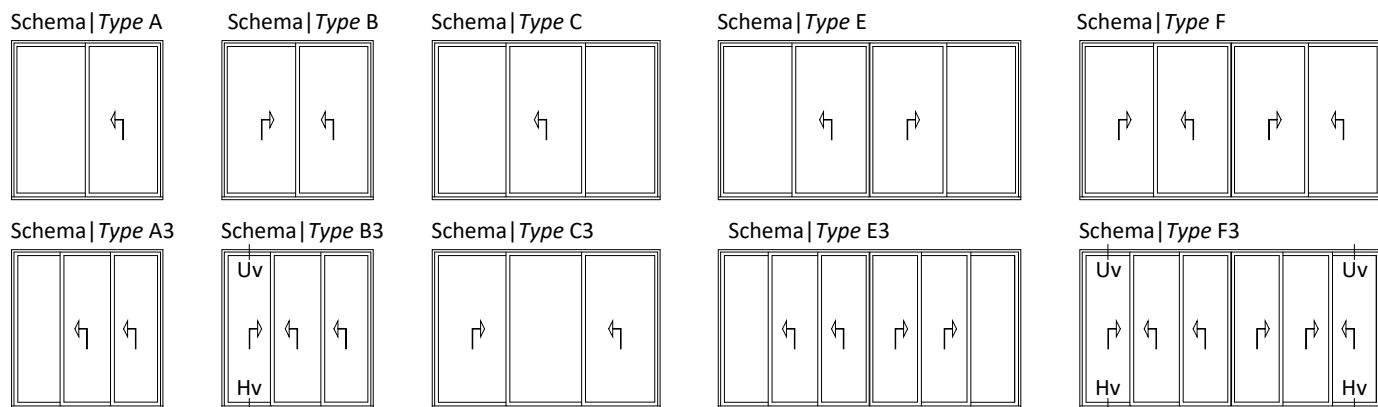



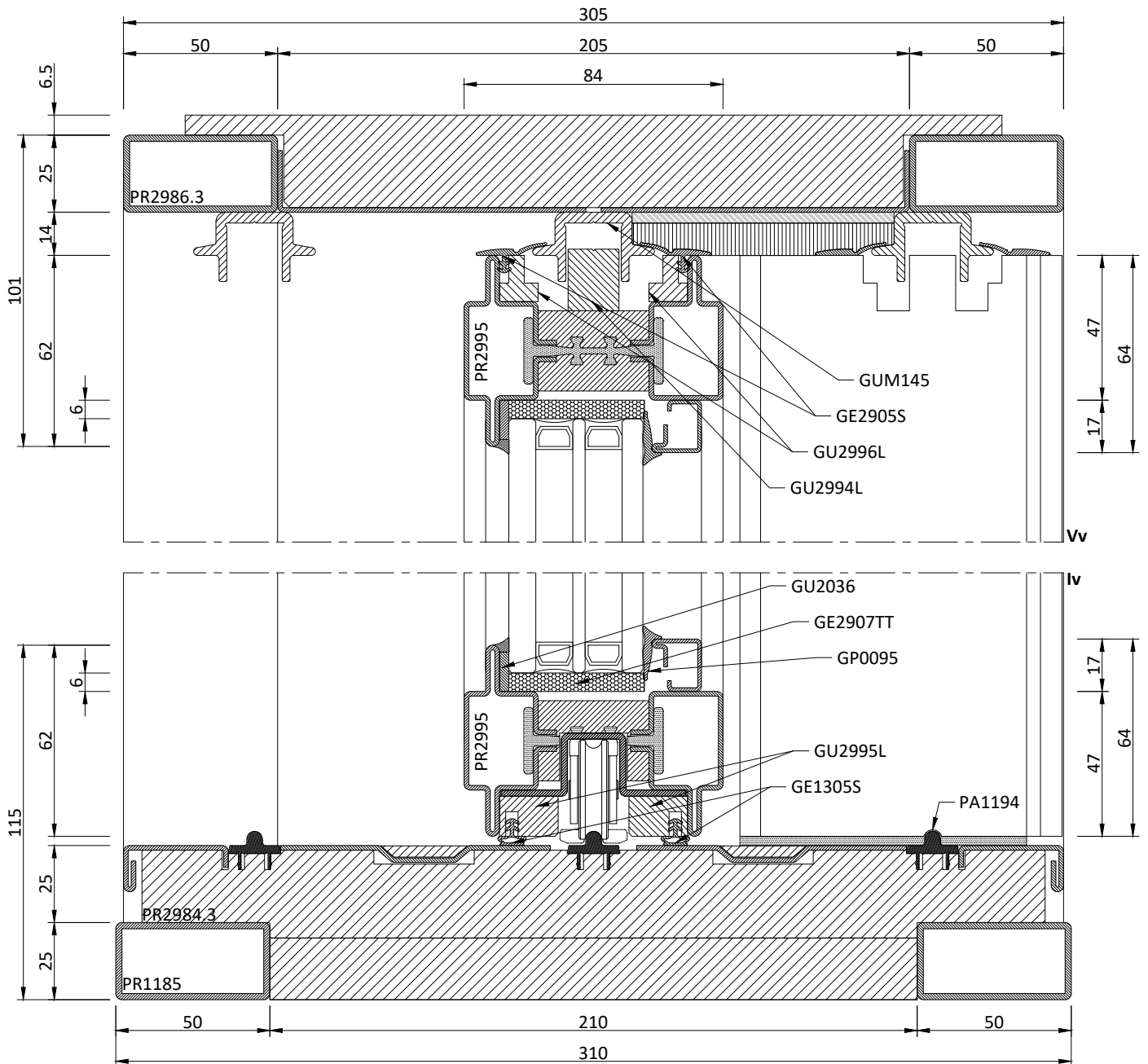
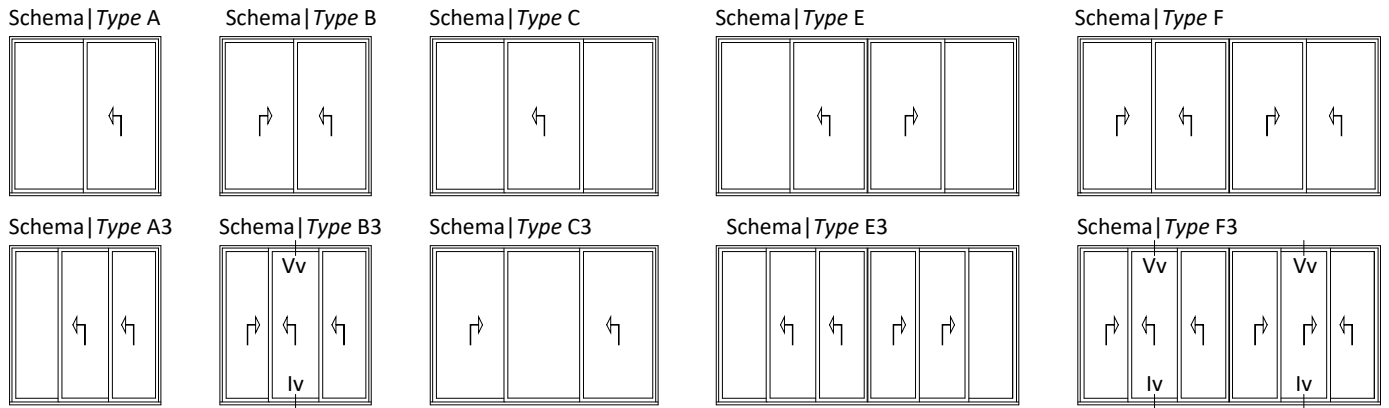

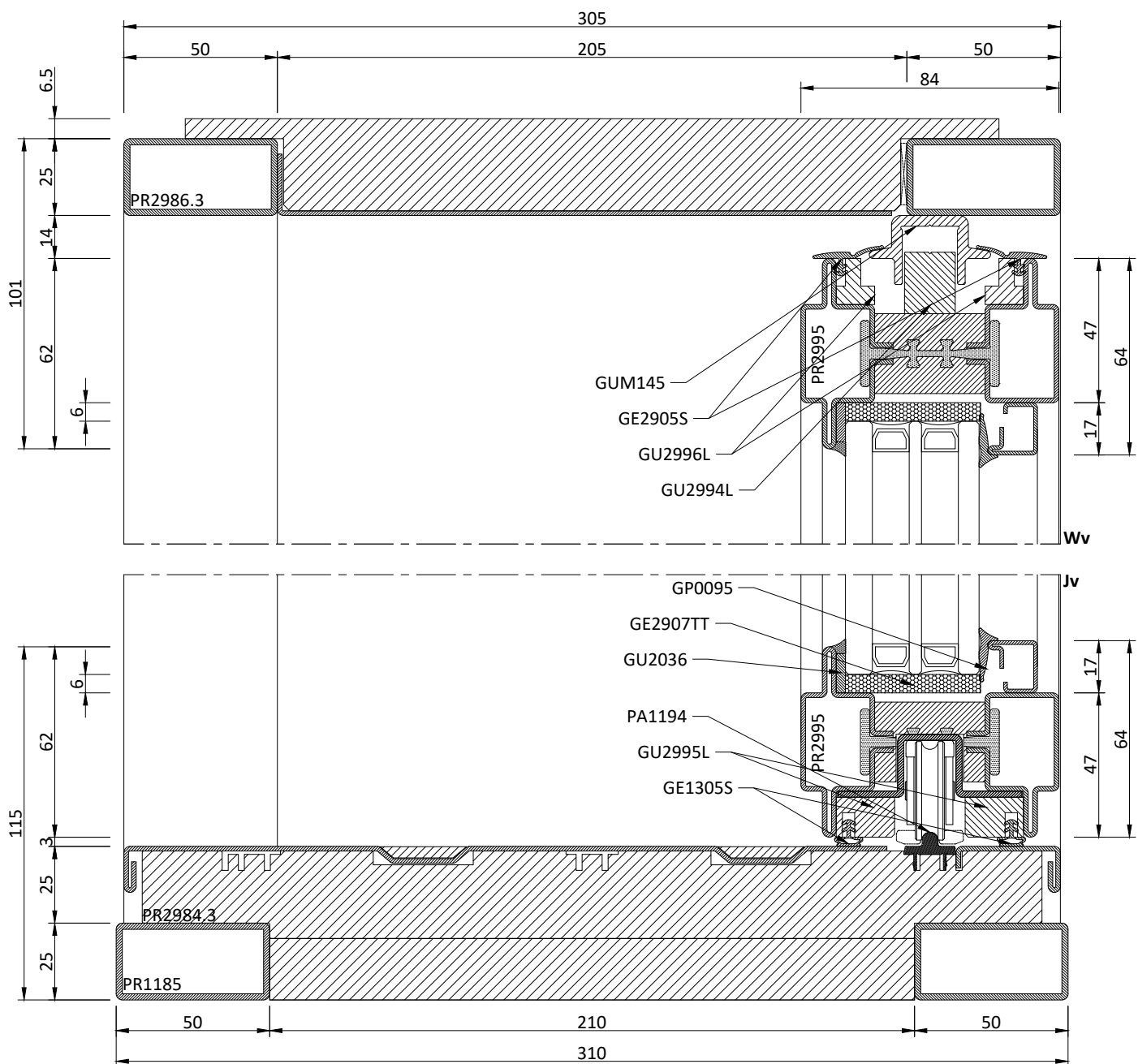
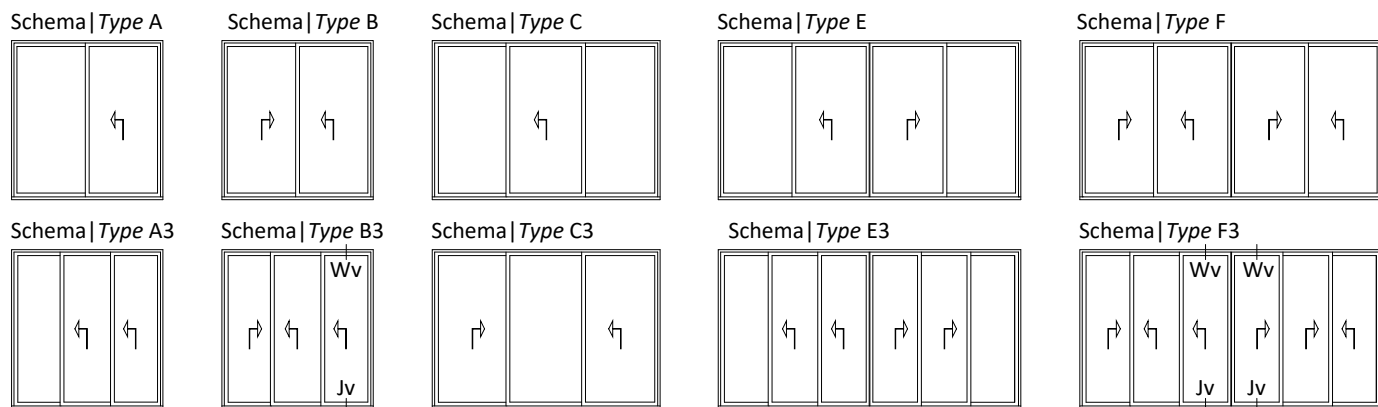

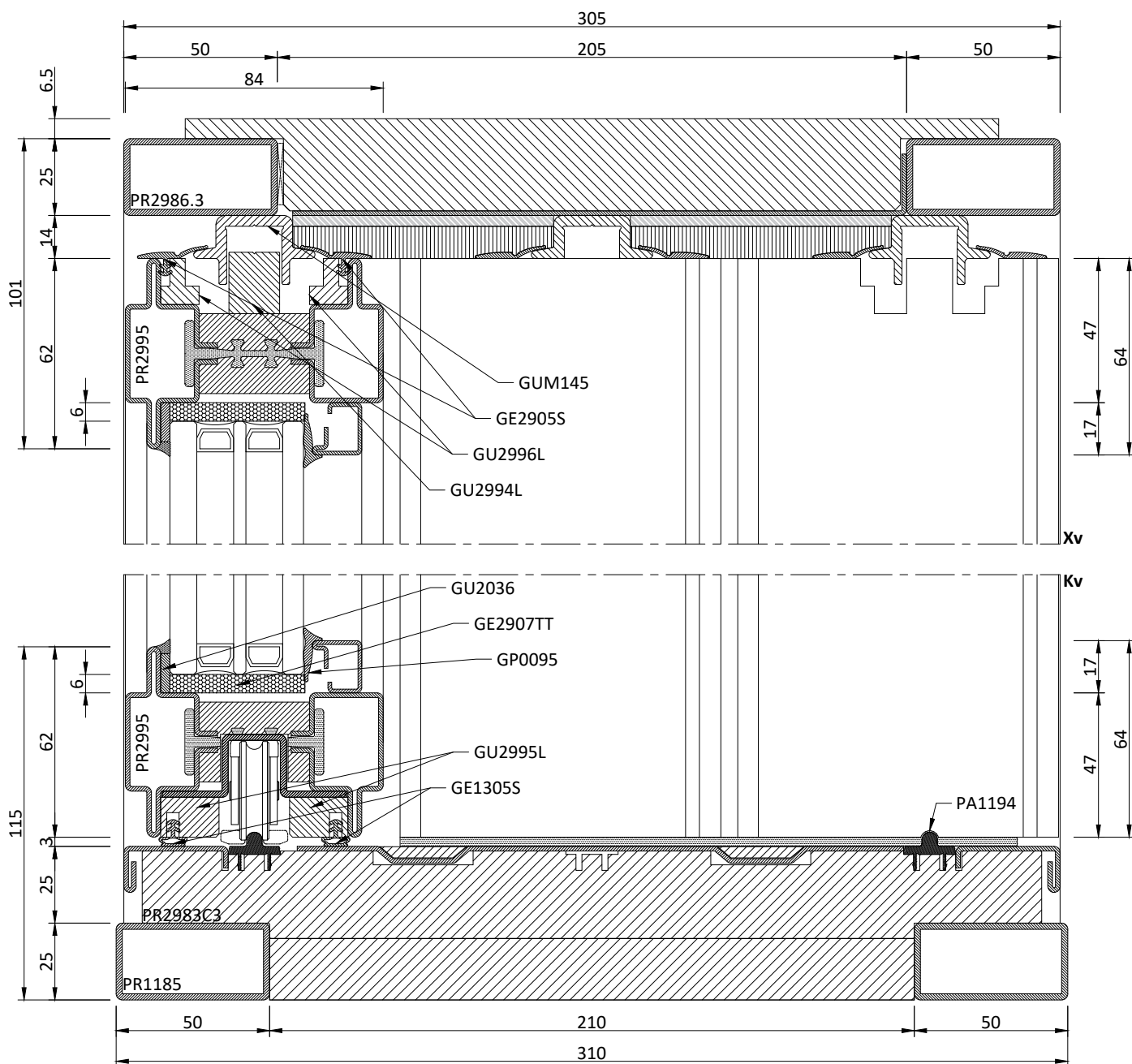
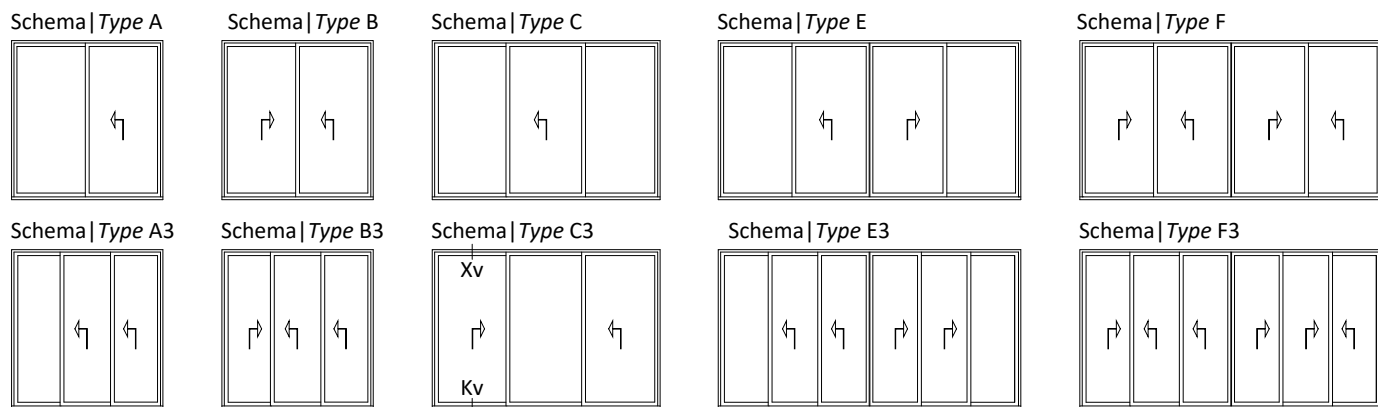

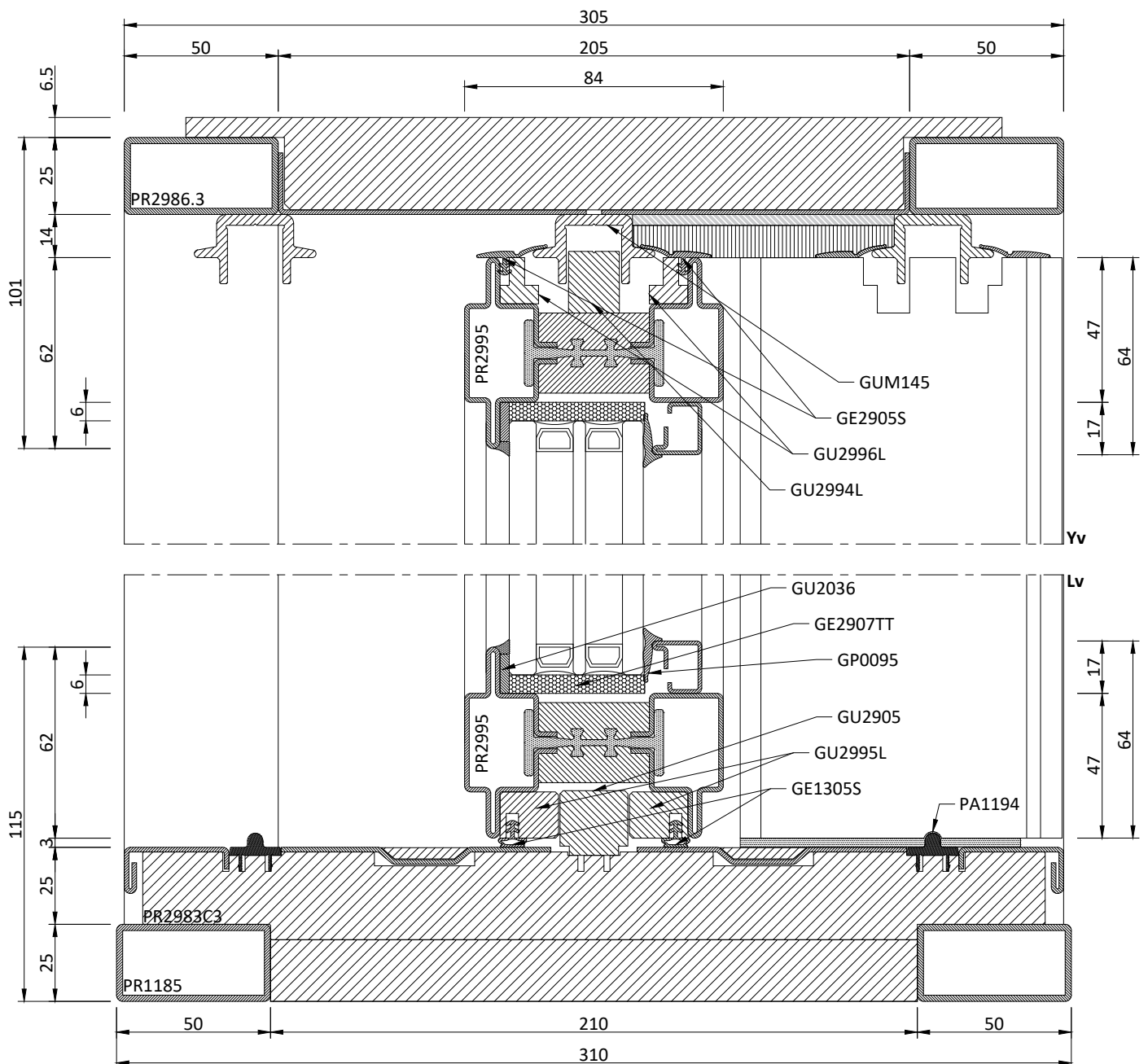
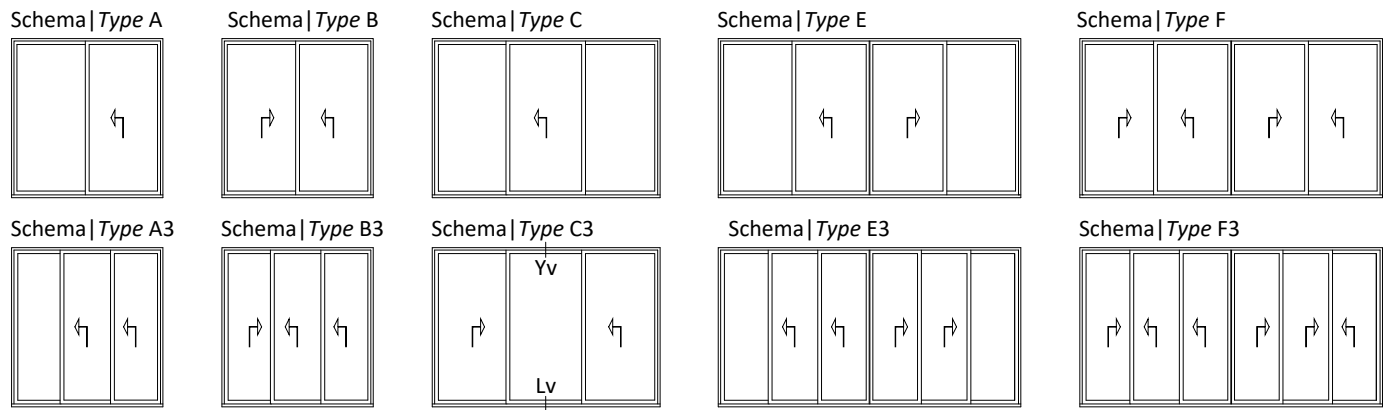

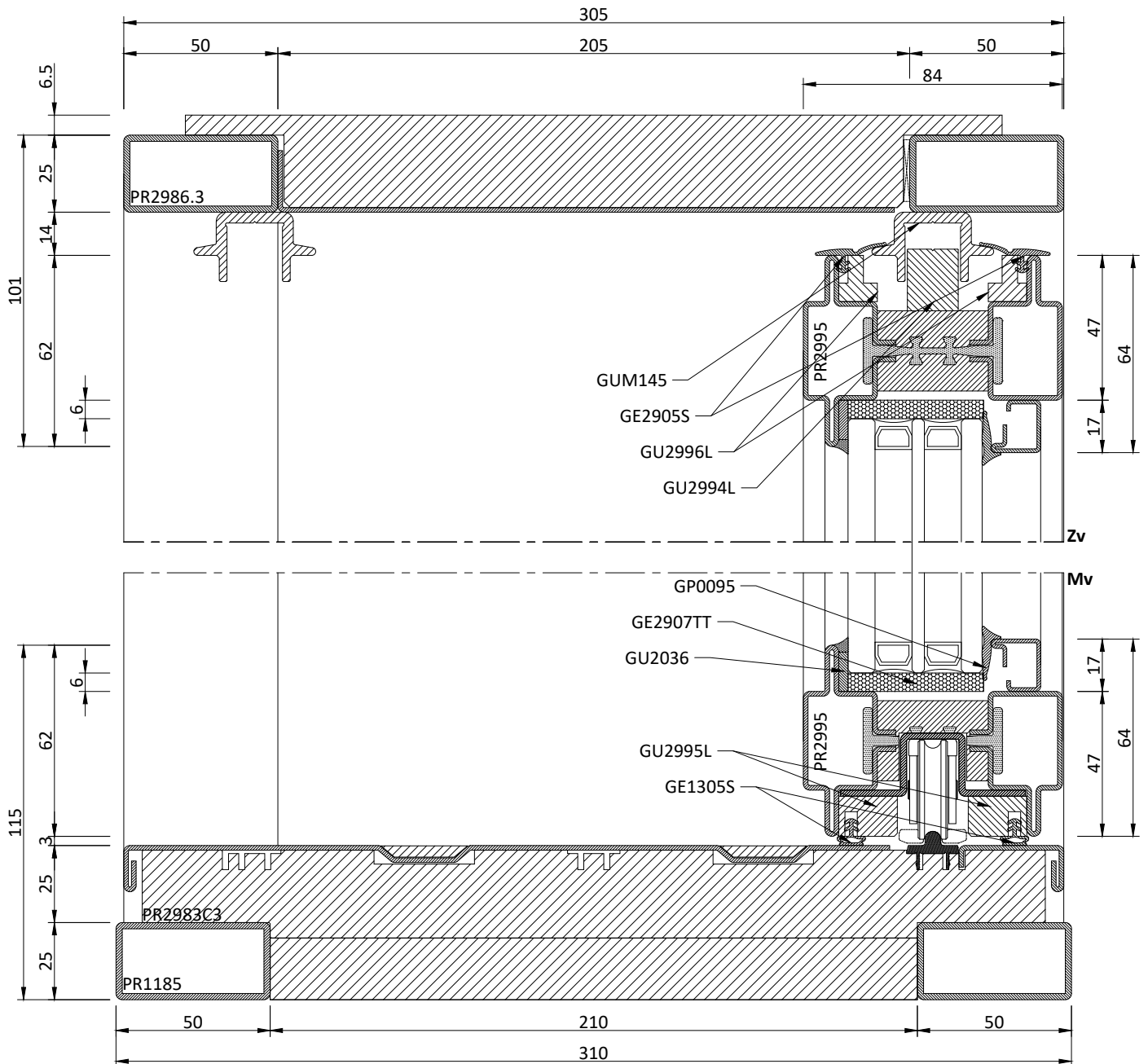
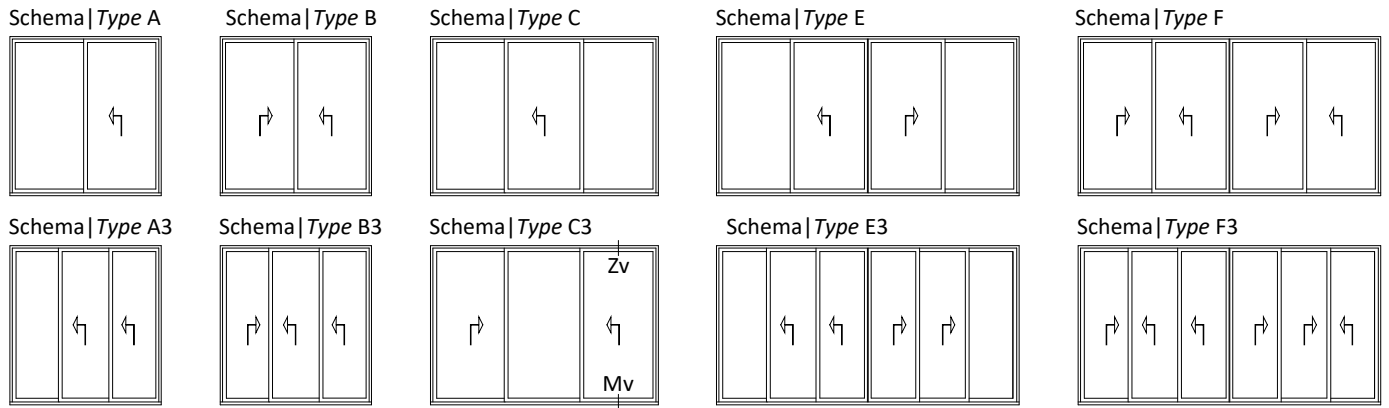

Schema | Type S1

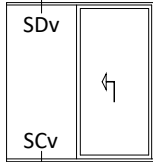

Schema | Type S2

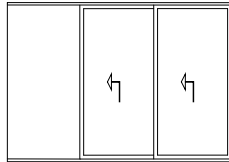

Schema | Type S3

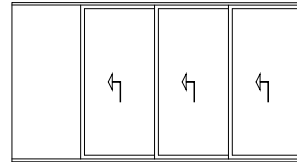

Schema | Type T1

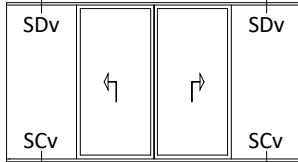

Schema | Type T2

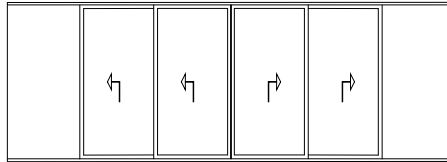

Schema | Type T3

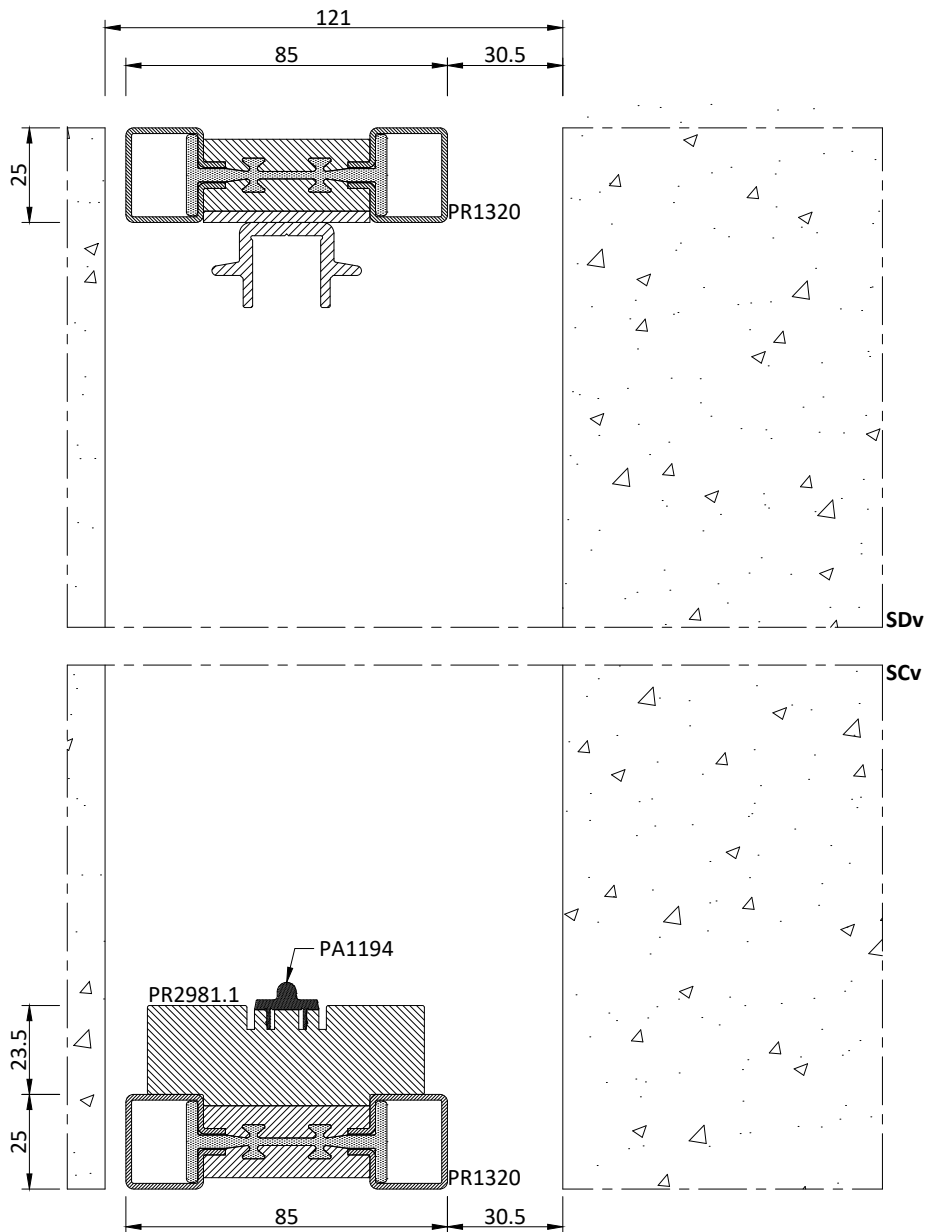
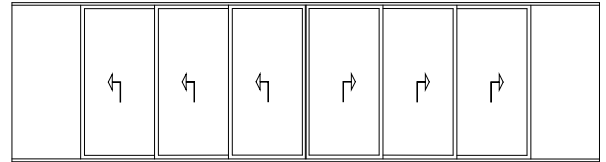

Schema | Type S1

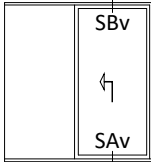

Schema | Type S2

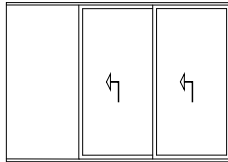

Schema | Type S3

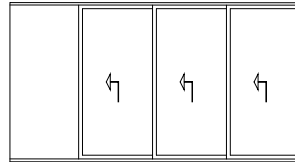

Schema | Type T1

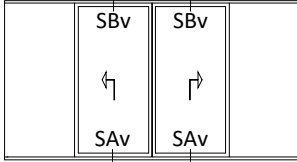

Schema | Type T2

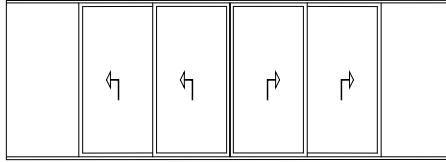

Schema | Type T3

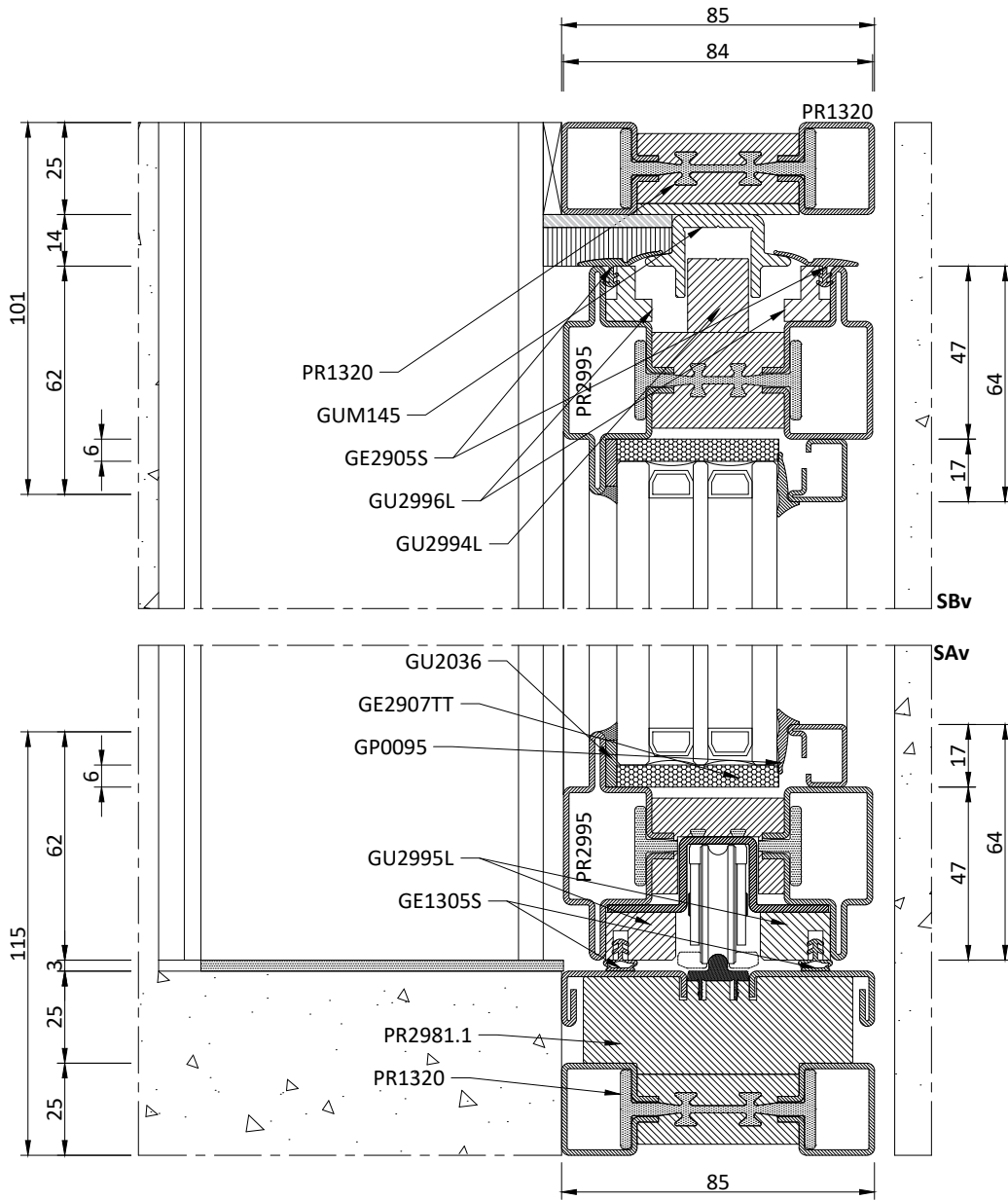
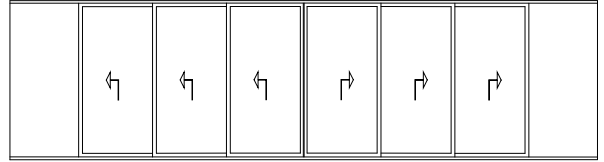

Schema | Type S1

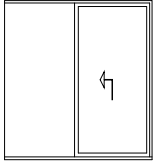

Schema | Type S2

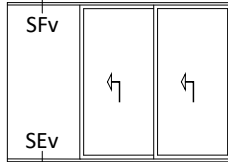

Schema | Type S3

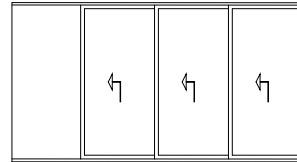

Schema | Type T1

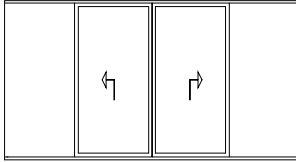

Schema | Type T2

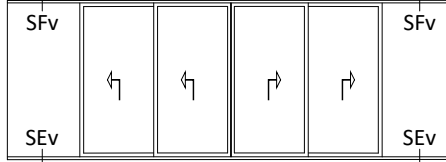

Schema | Type T3

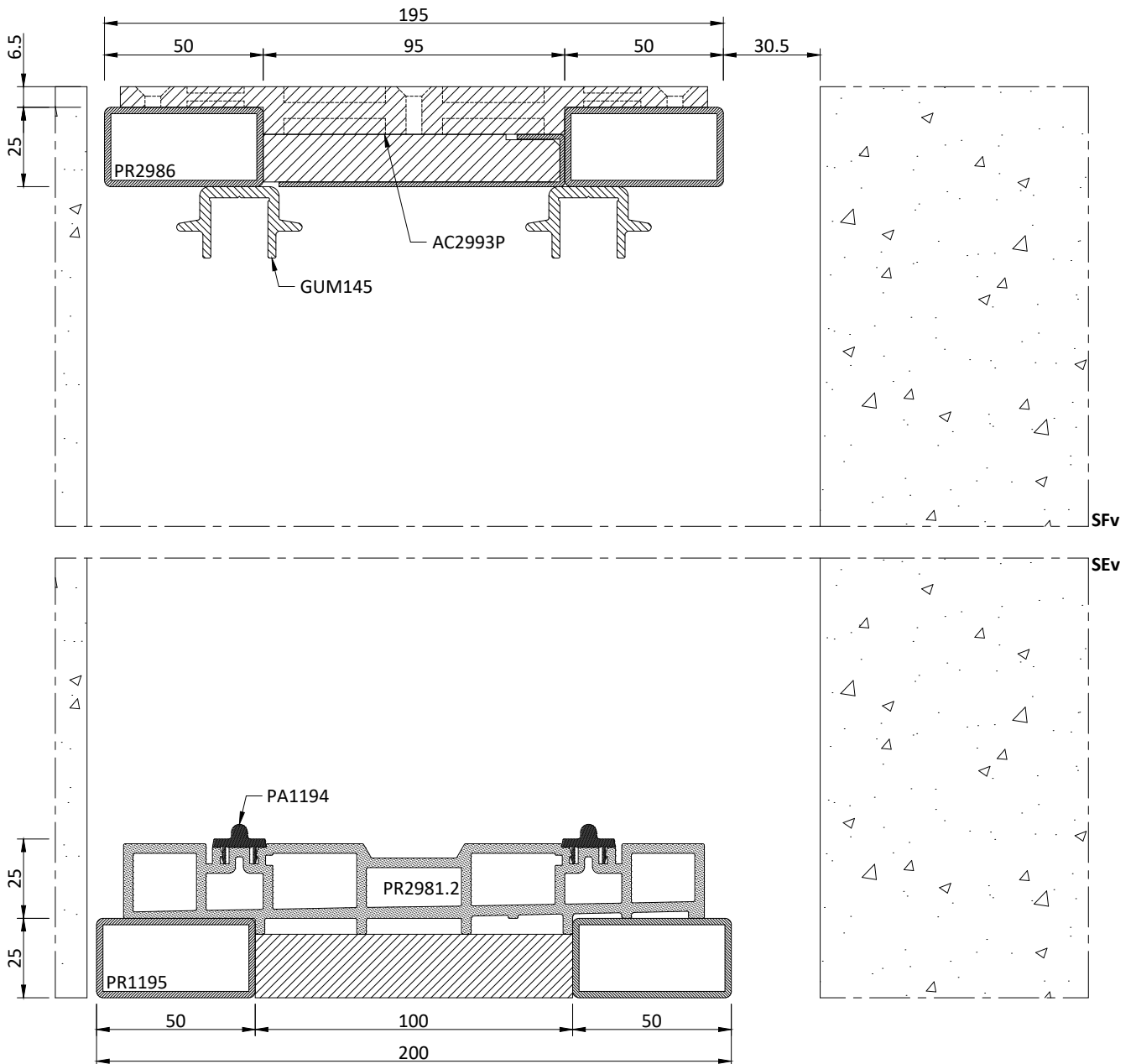
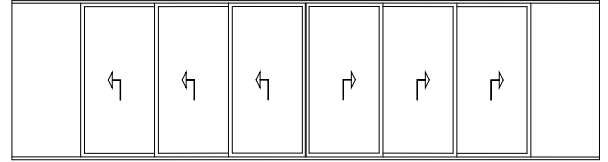



Schema | Type S1

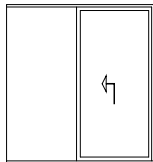

Schema | Type S2

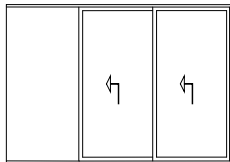

Schema | Type S3

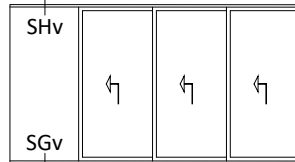

Schema | Type T1

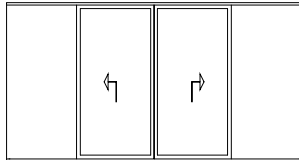

Schema | Type T2

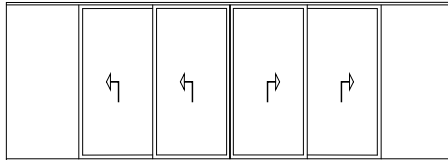

Schema | Type T3

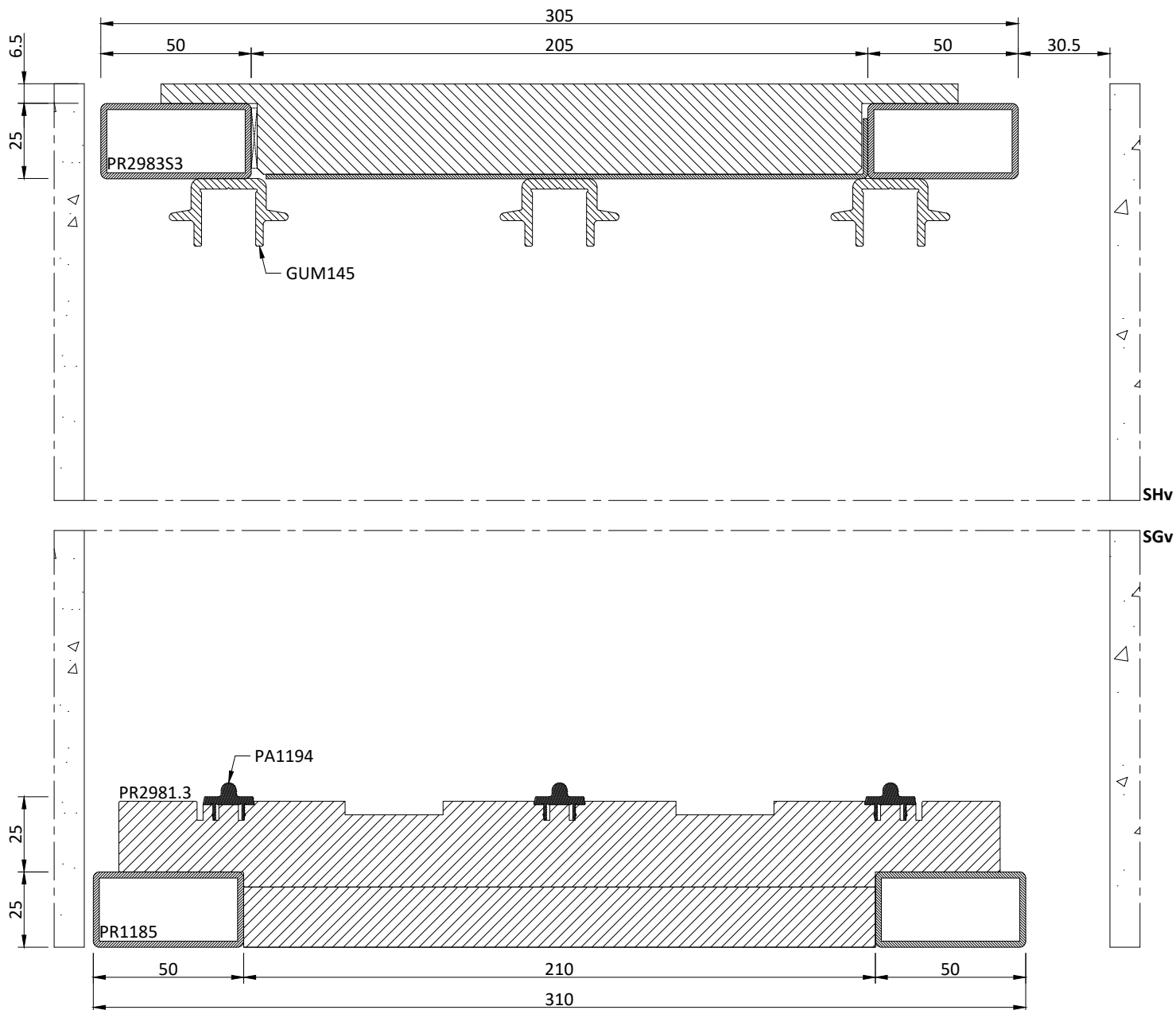
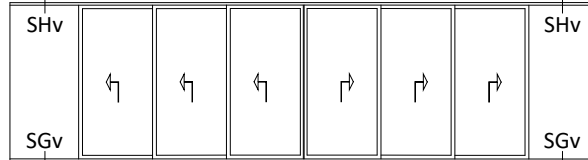

Schema | Type S1

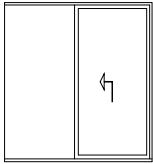

Schema | Type S2

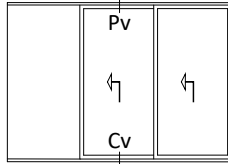

Schema | Type S3

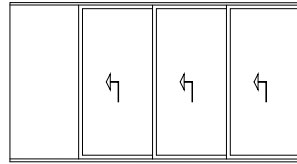

Schema | Type T1

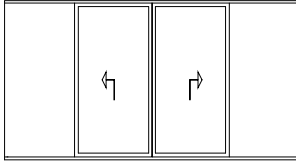

Schema | Type T2

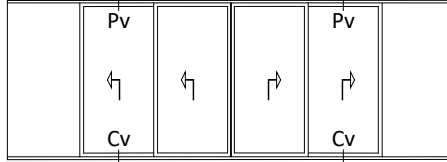

Schema | Type T3

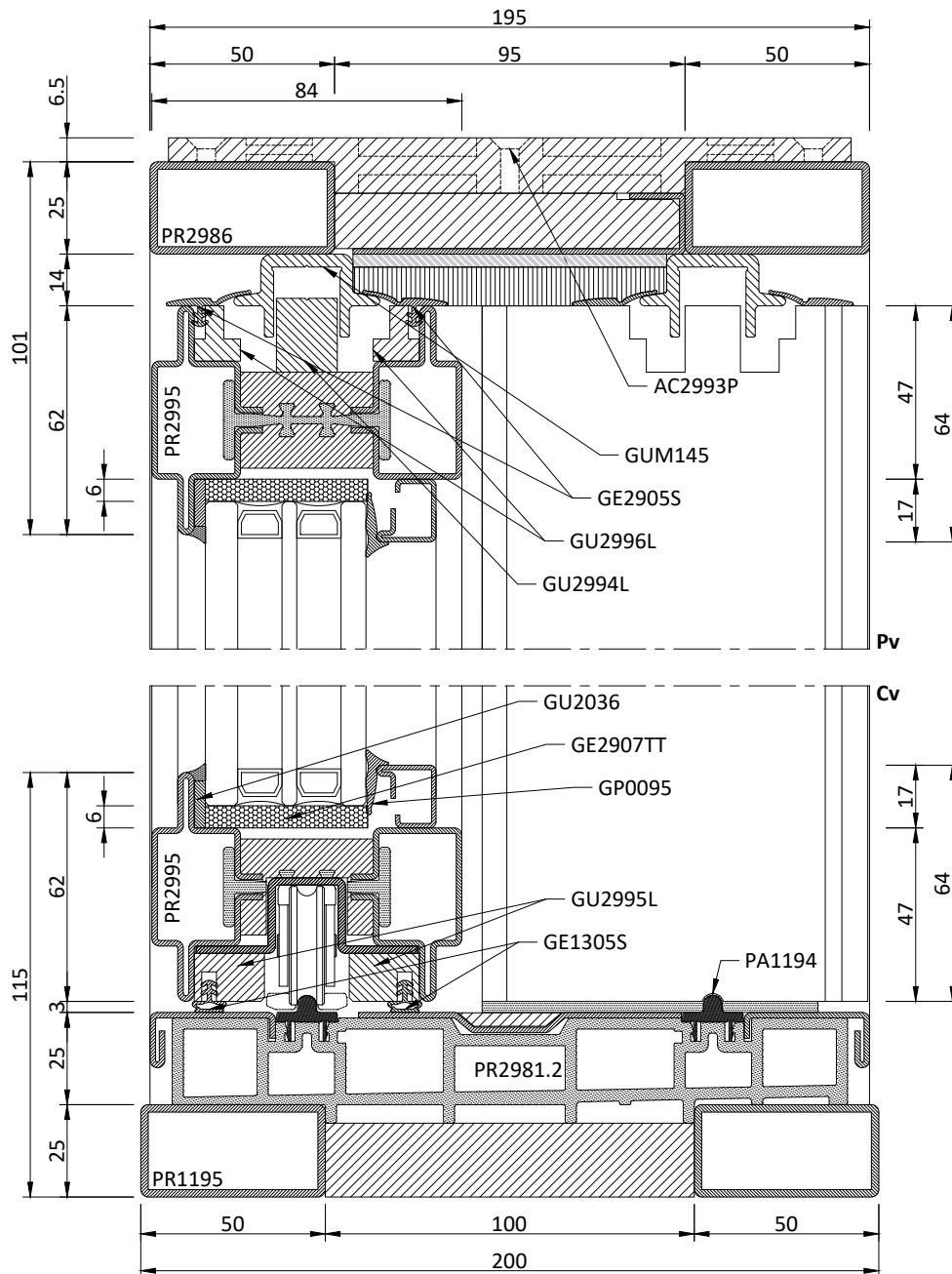
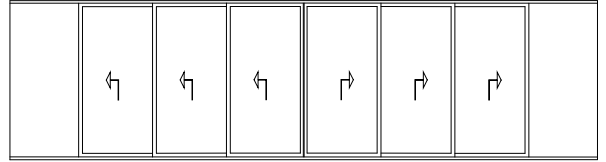

Schema | Type S1

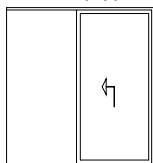

Schema | Type S2

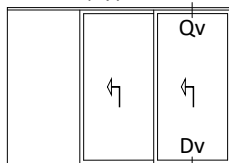

Schema | Type S3

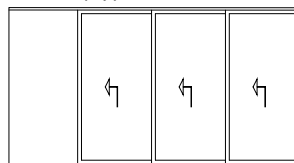

Schema | Type T1

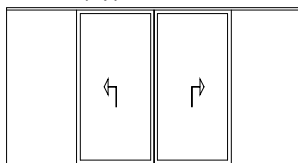

Schema | Type T2

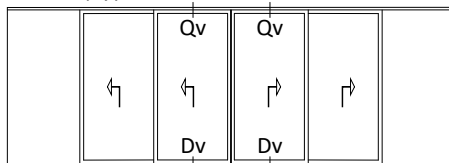

Schema | Type T3

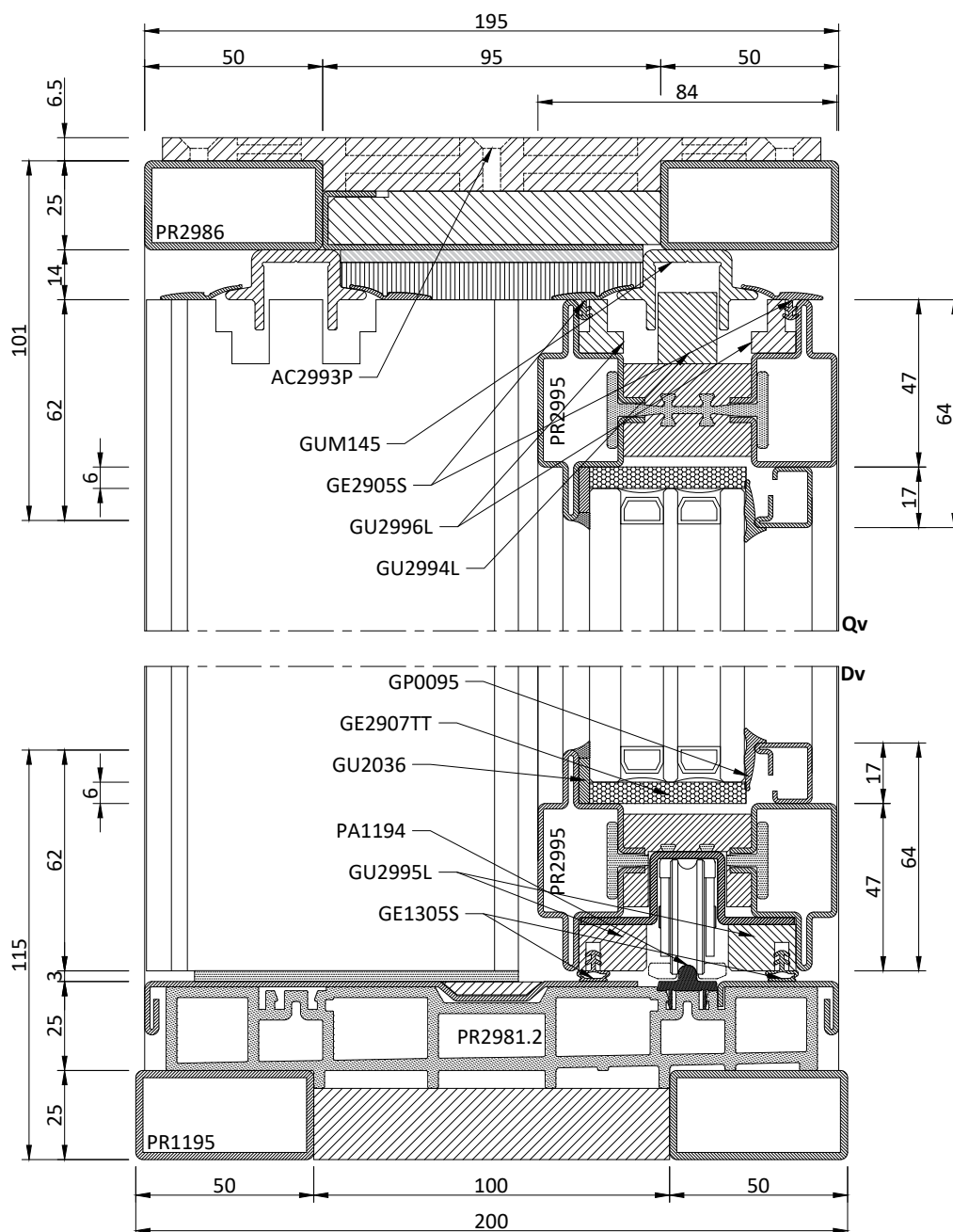
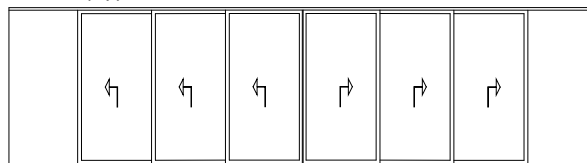

Schema | Type S1

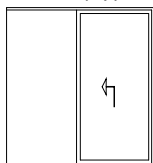

Schema | Type S2

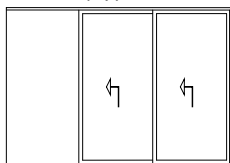

Schema | Type S3

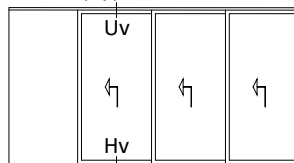

Schema | Type T1

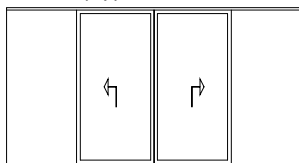

Schema | Type T2

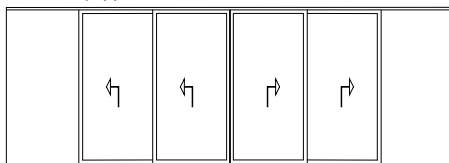

Schema | Type T3

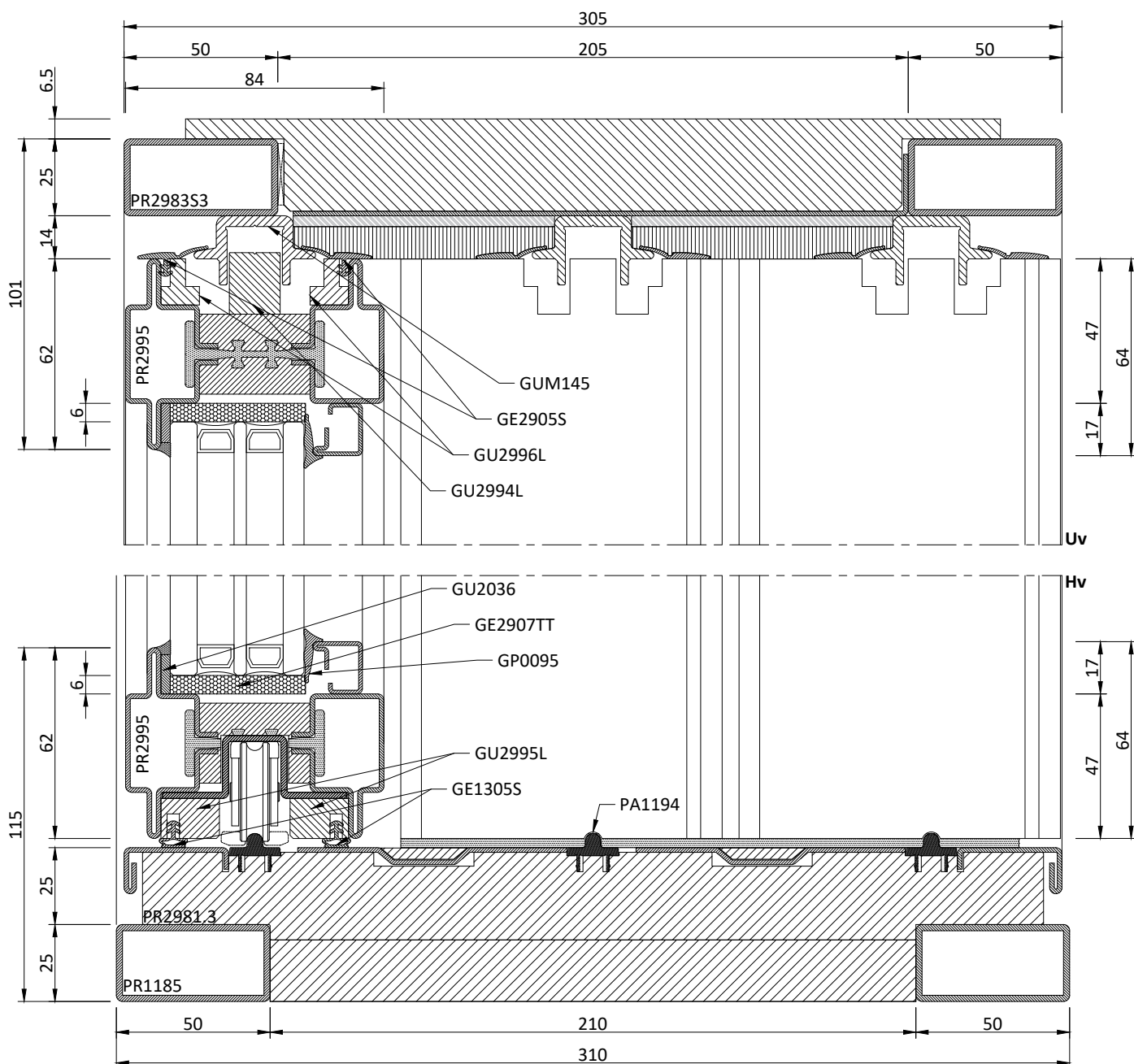
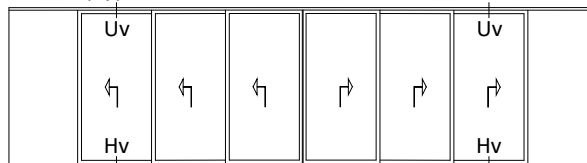

Schema | Type S1

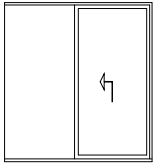

Schema | Type S2

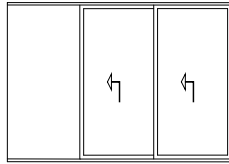

Schema | Type S3

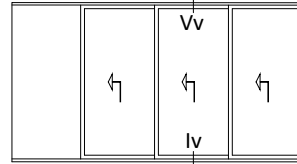

Schema | Type T1

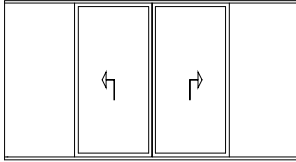

Schema | Type T2

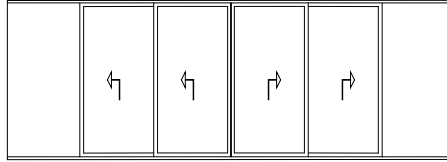

Schema | Type T3

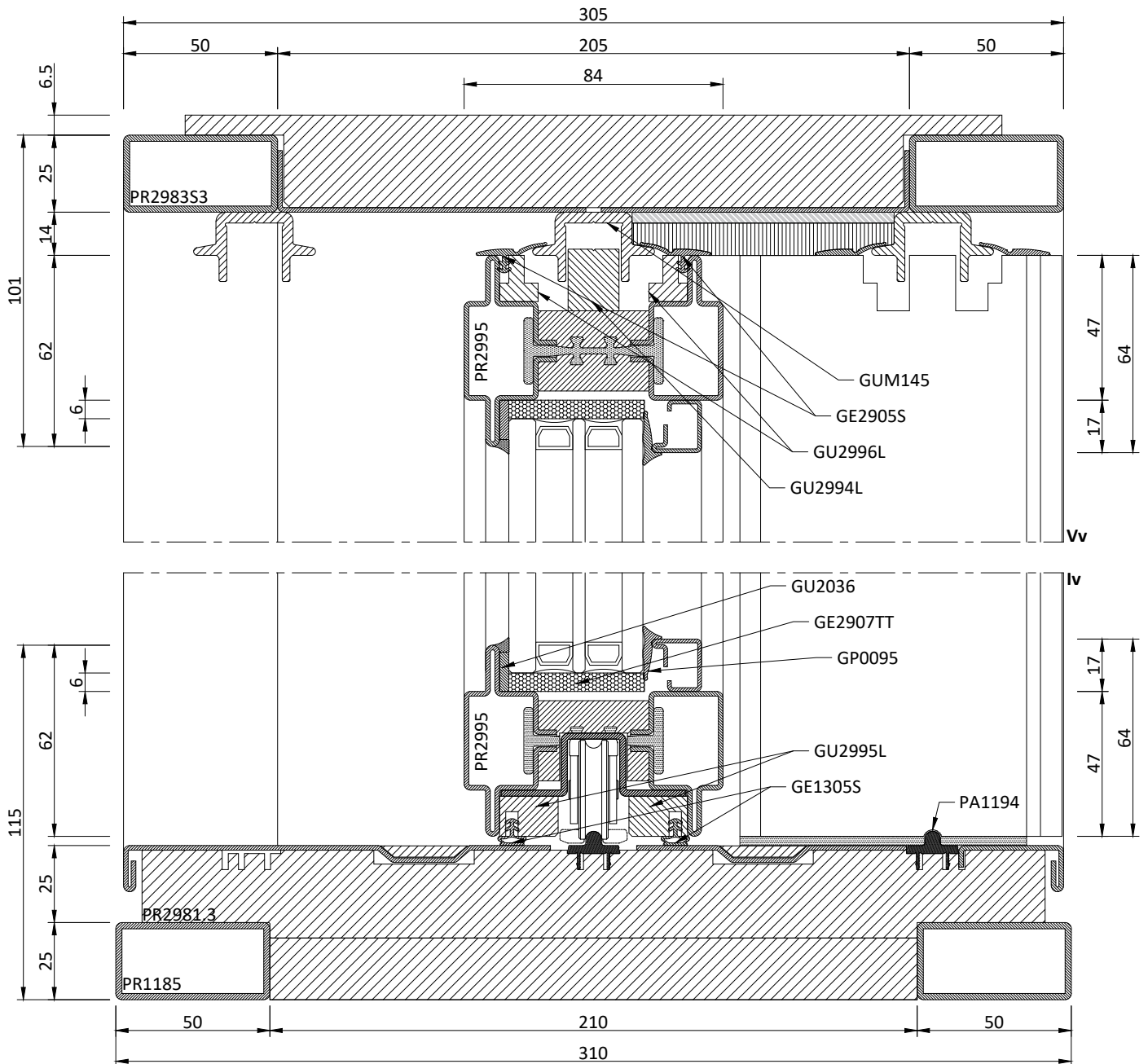
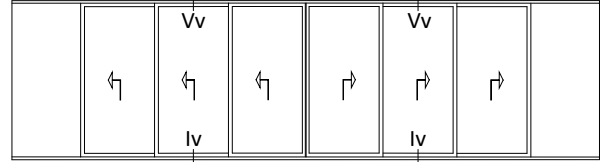

Schema | Type S1

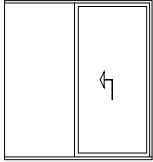

Schema | Type S2

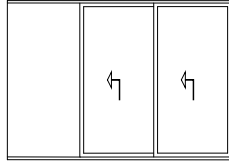

Schema | Type S3

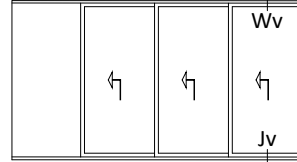

Schema | Type T1

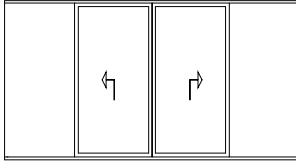

Schema | Type T2

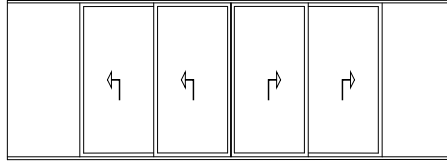

Schema | Type T3

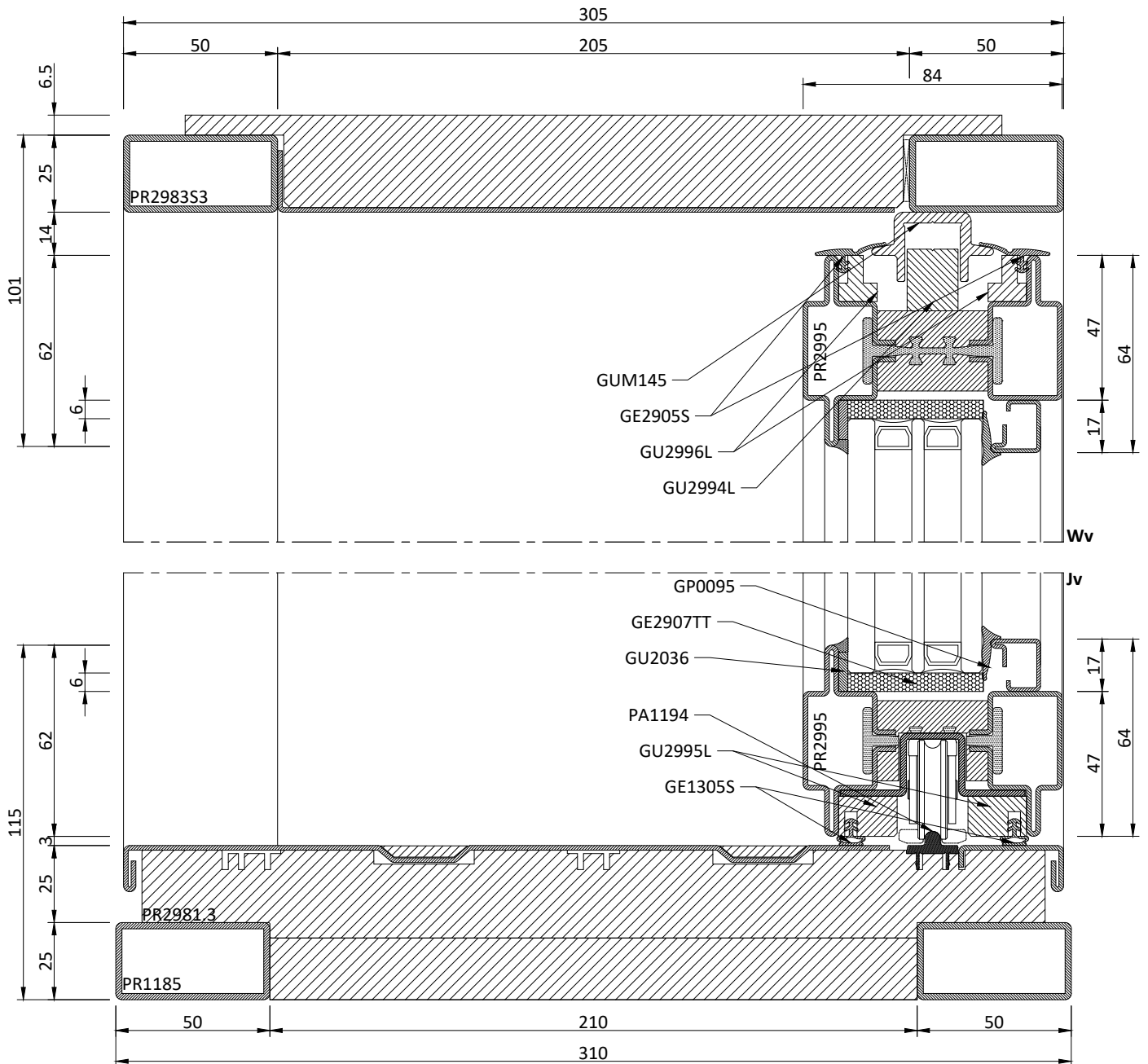
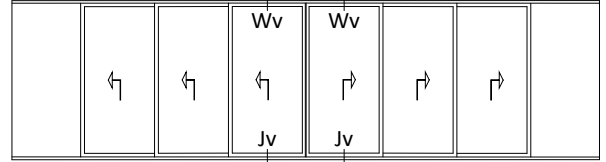

Schema | Type S1

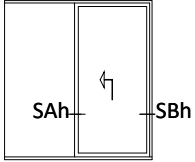

Schema | Type S2

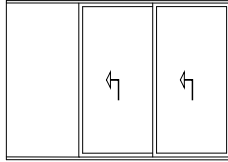

Schema | Type S3

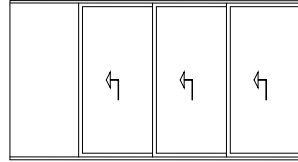

Schema | Type T1

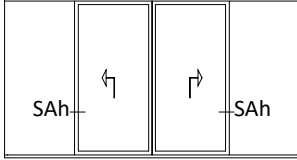

Schema | Type T2

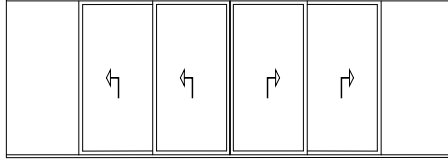

Schema | Type T3

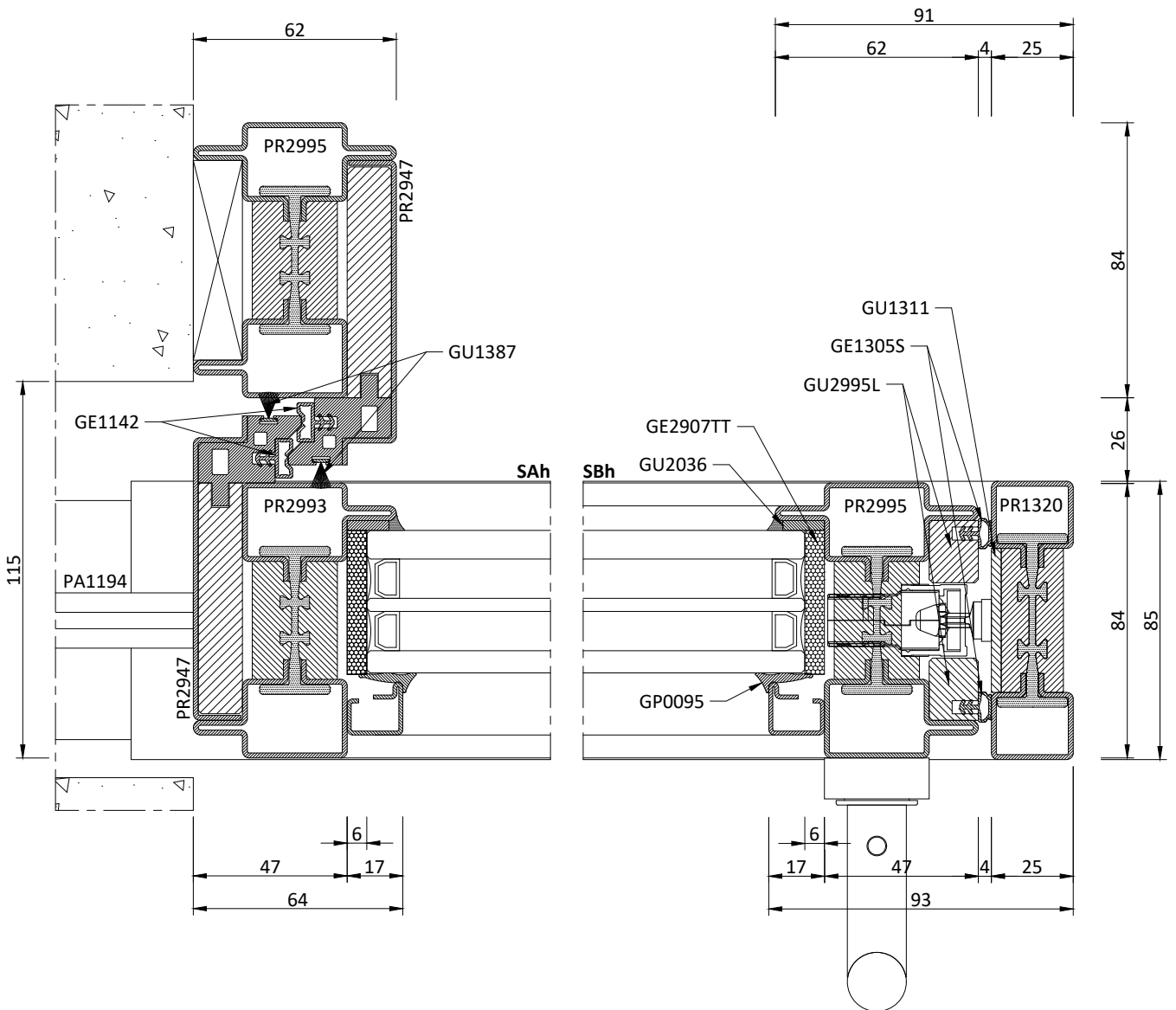
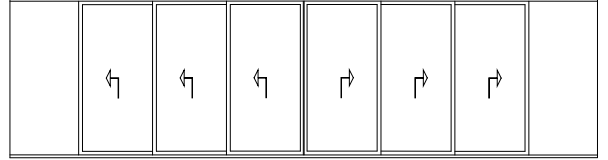

Schema | Type S1

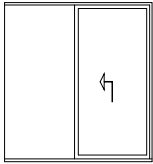

Schema | Type S2

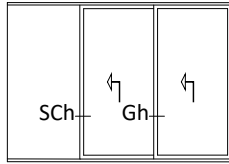

Schema | Type S3

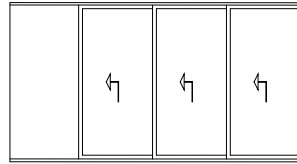

Schema | Type T1

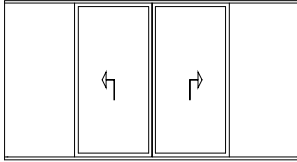

Schema | Type T2

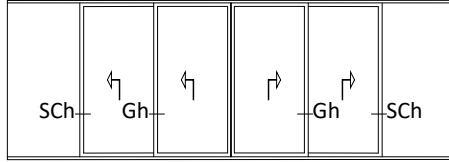

Schema | Type T3

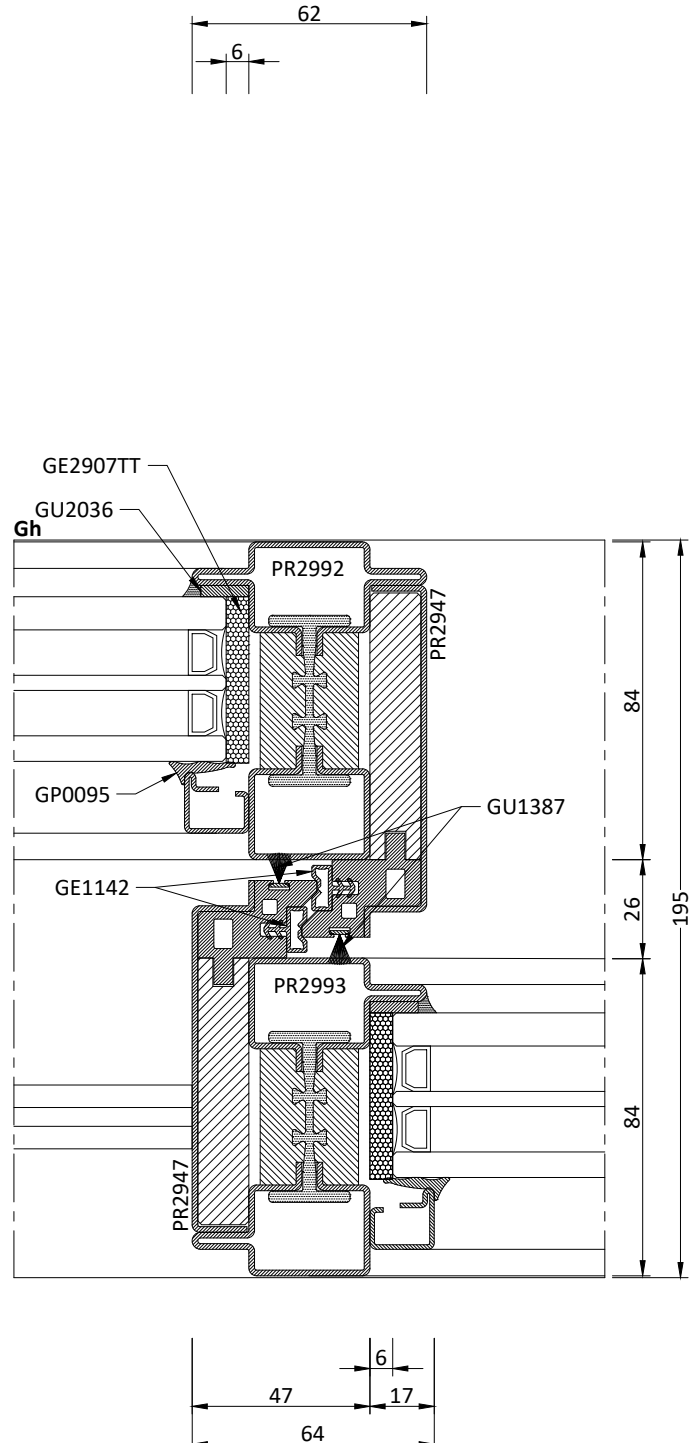
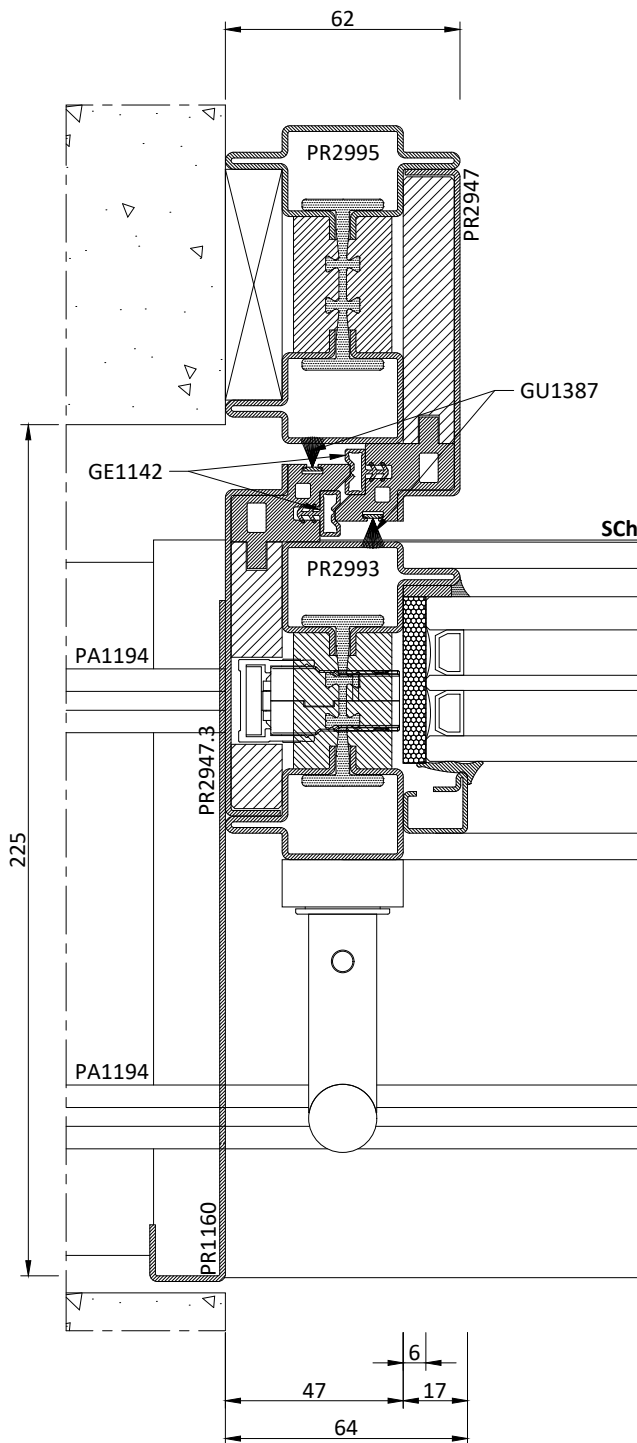
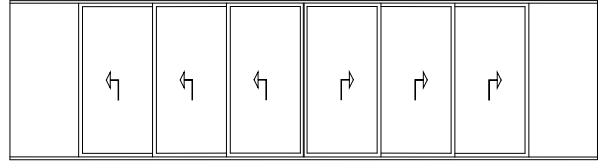



Schema | Type S1

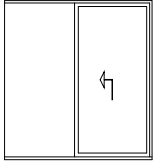

Schema | Type S2

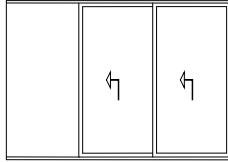

Schema | Type S3

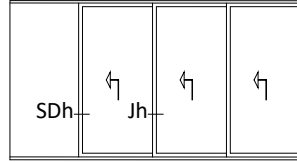

Schema | Type T1

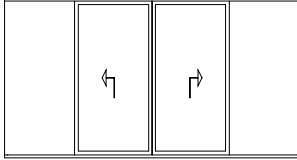

Schema | Type T2

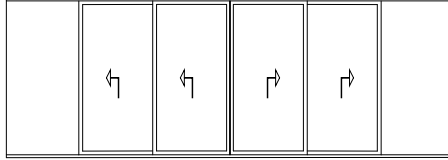

Schema | Type T3

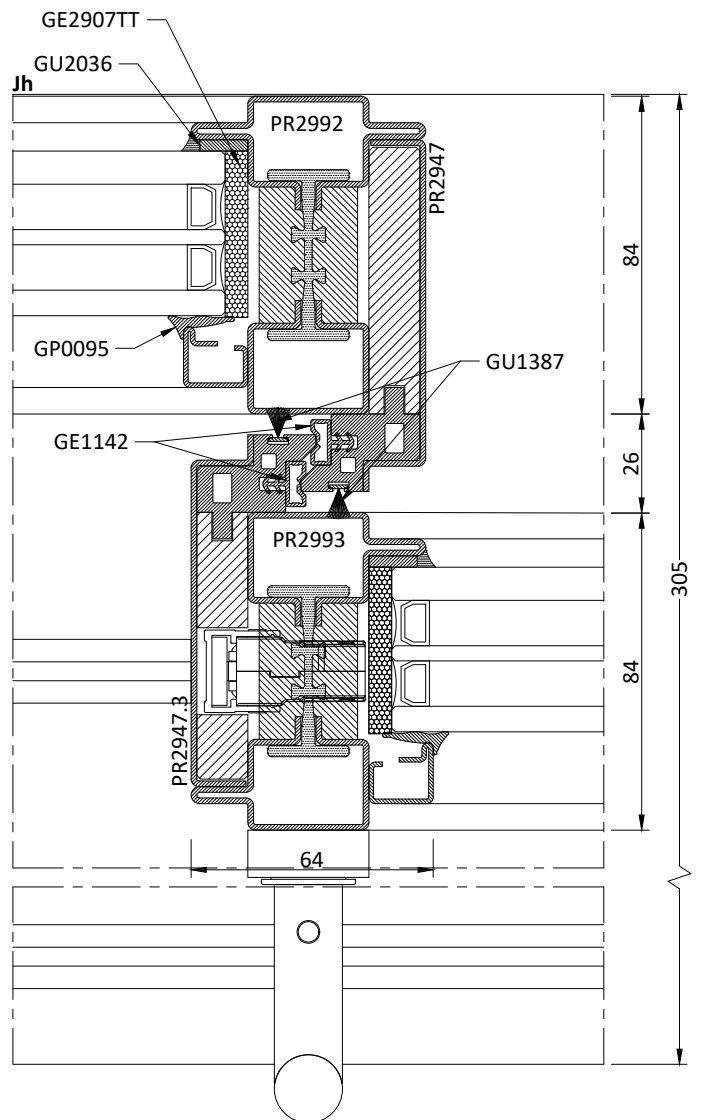
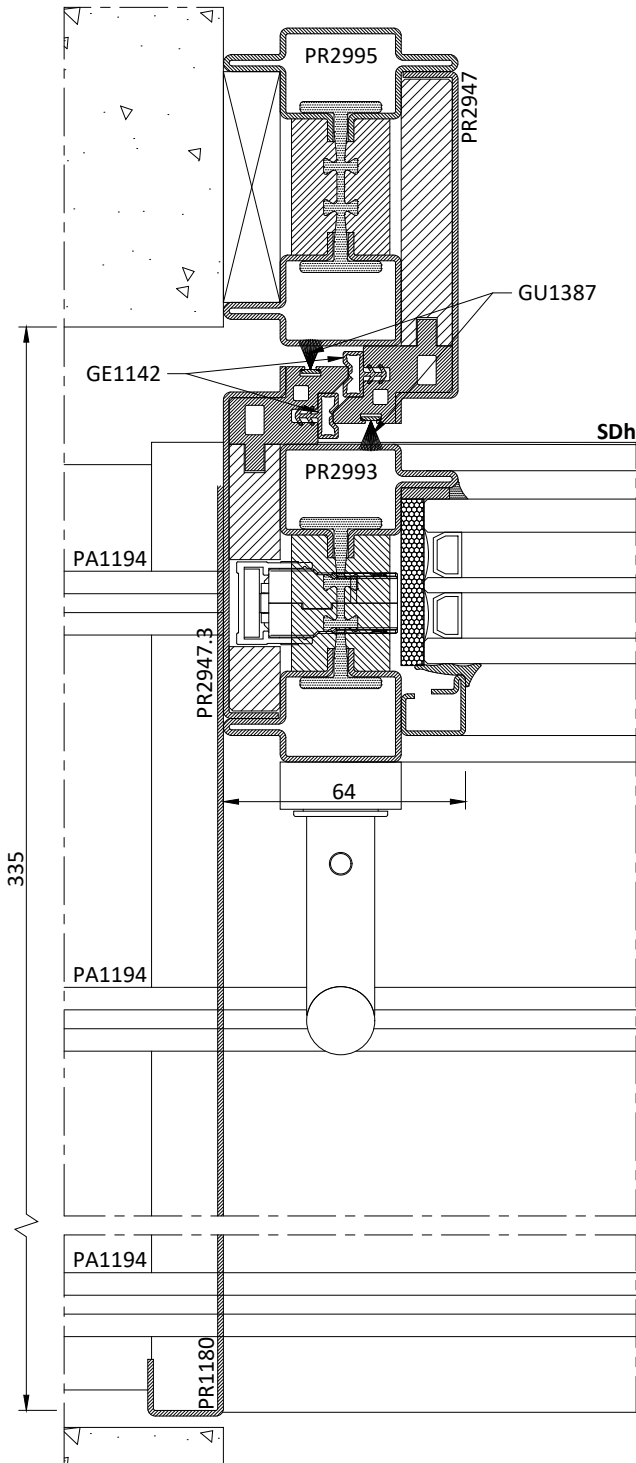
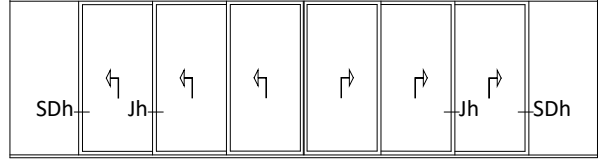

Schema | Type S1

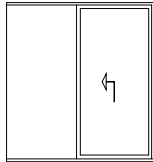

Schema | Type S2

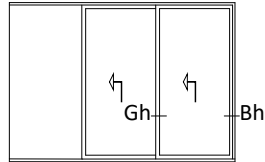

Schema | Type S3

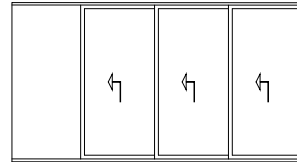

Schema | Type T1

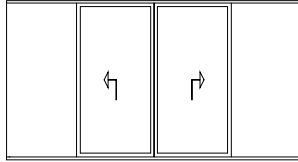

Schema | Type T2

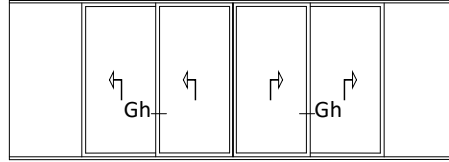

Schema | Type T3

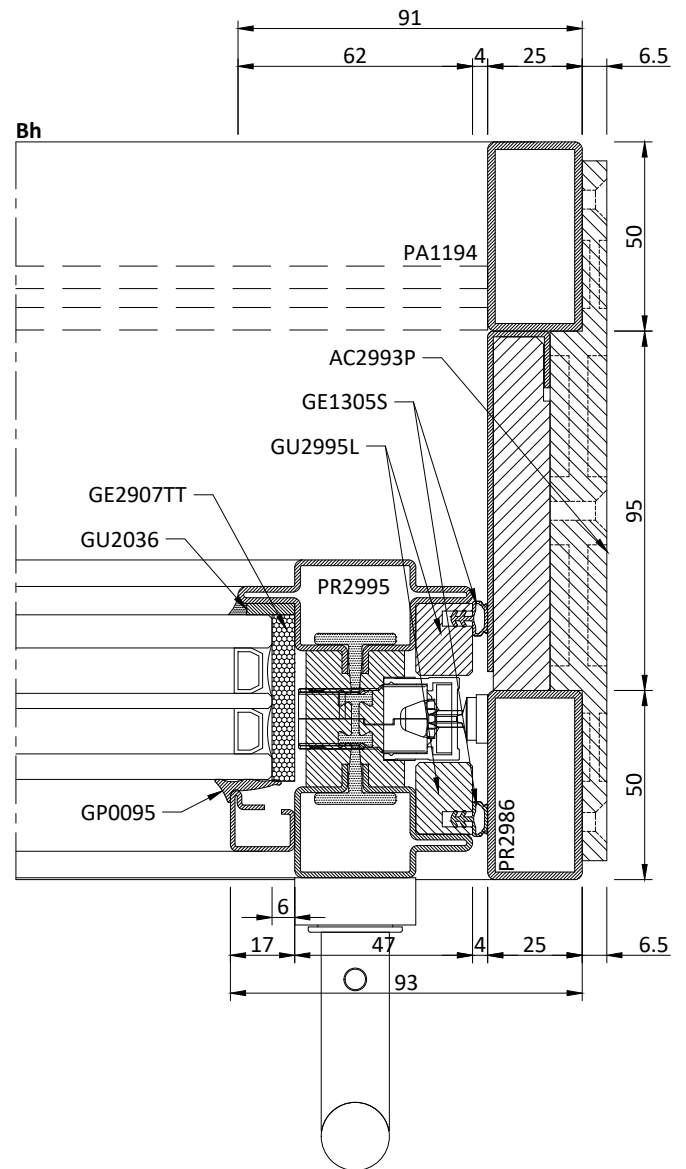
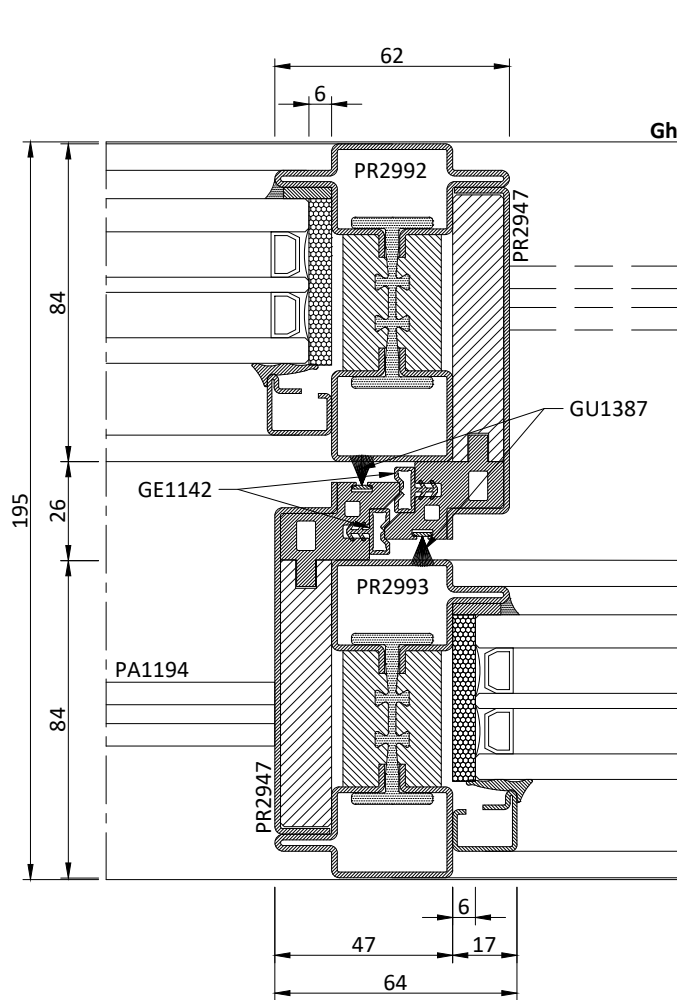
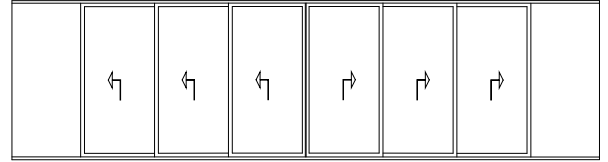

Schema | Type S1

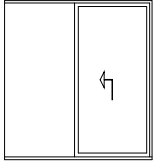

Schema | Type S2

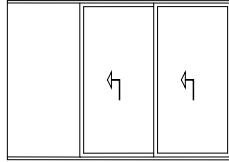

Schema | Type S3

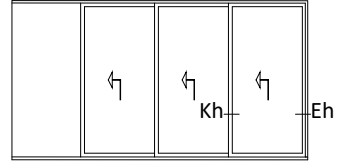

Schema | Type T1

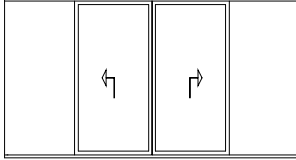

Schema | Type T2

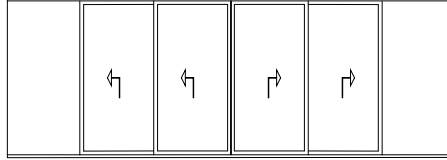

Schema | Type T3

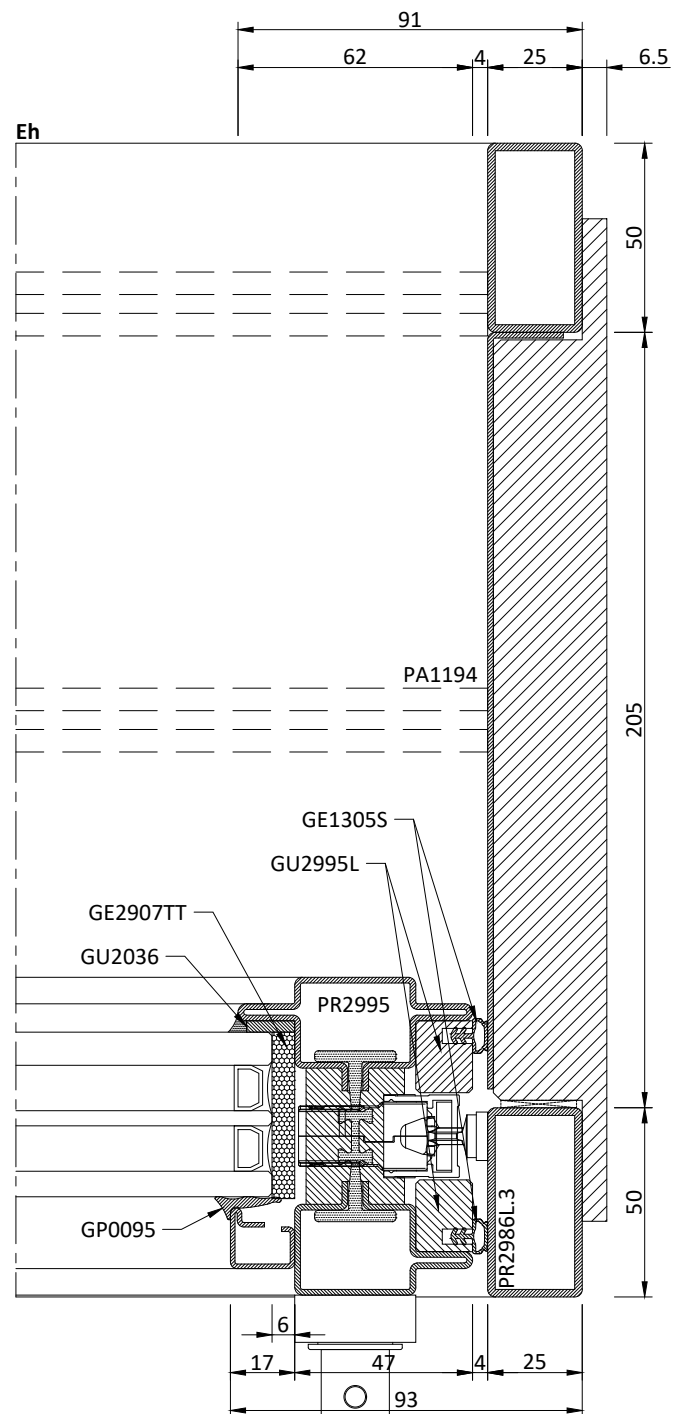
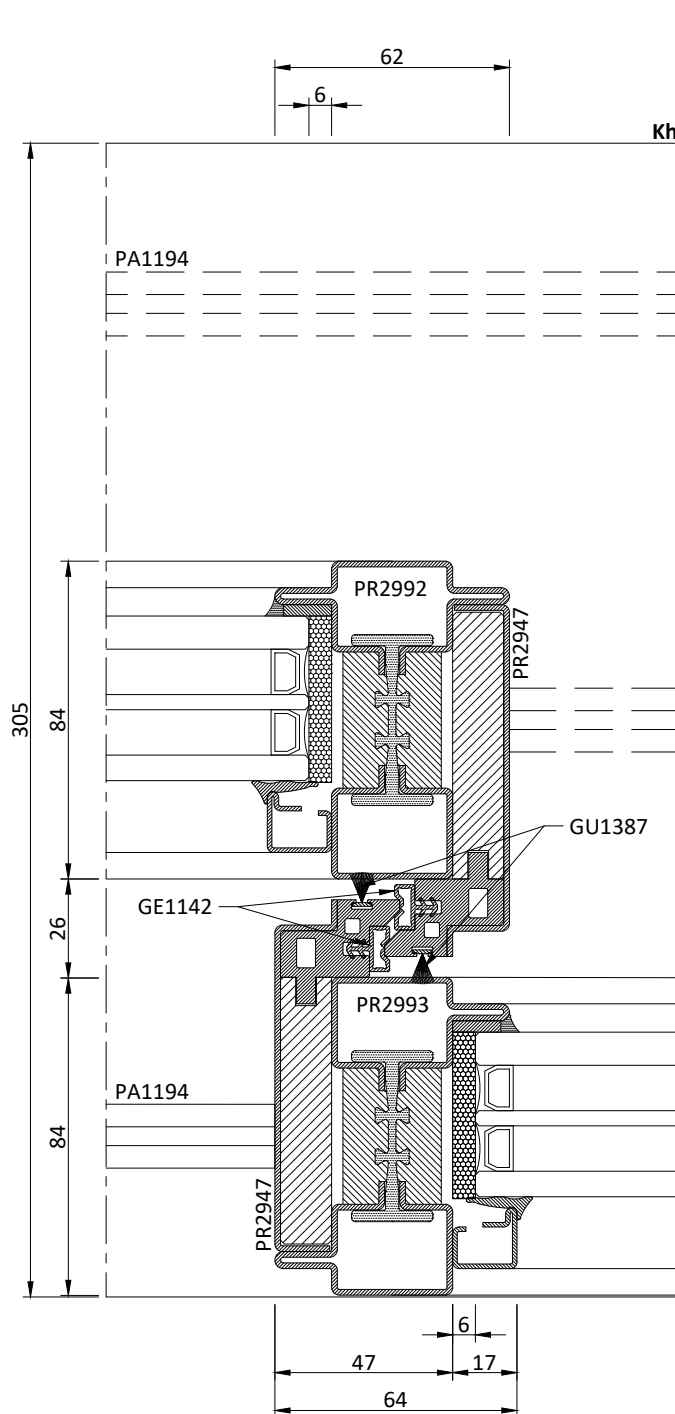
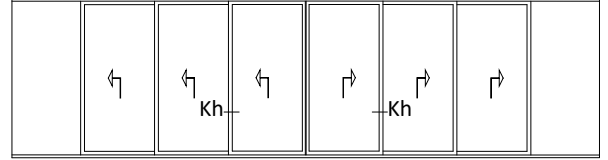

Schema | Type S1

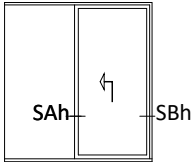

Schema | Type S2

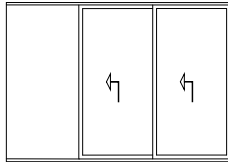

Schema | Type S3

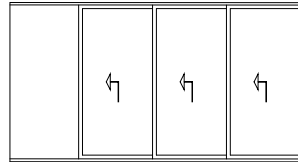

Schema | Type T1

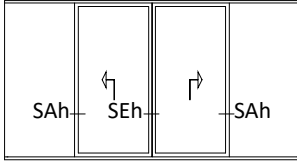

Schema | Type T2

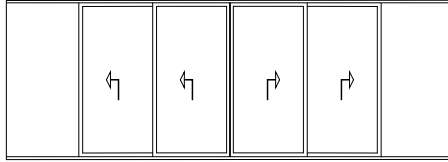

Schema | Type T3

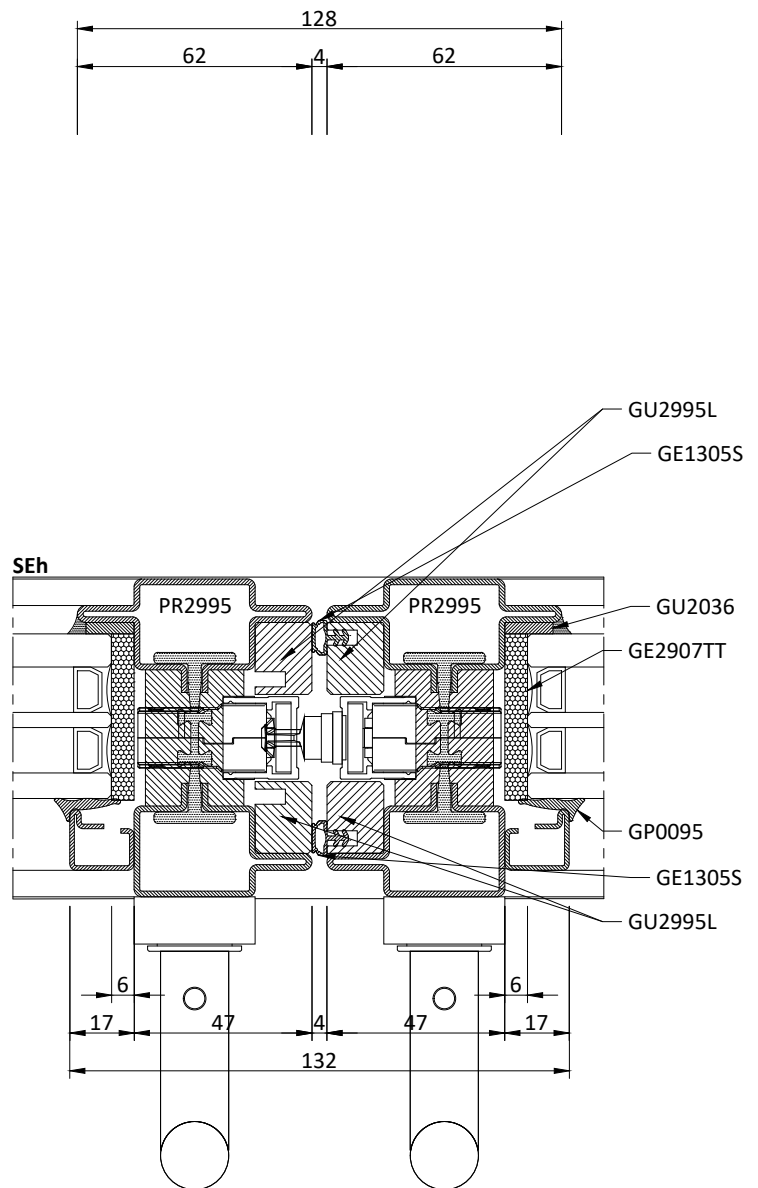
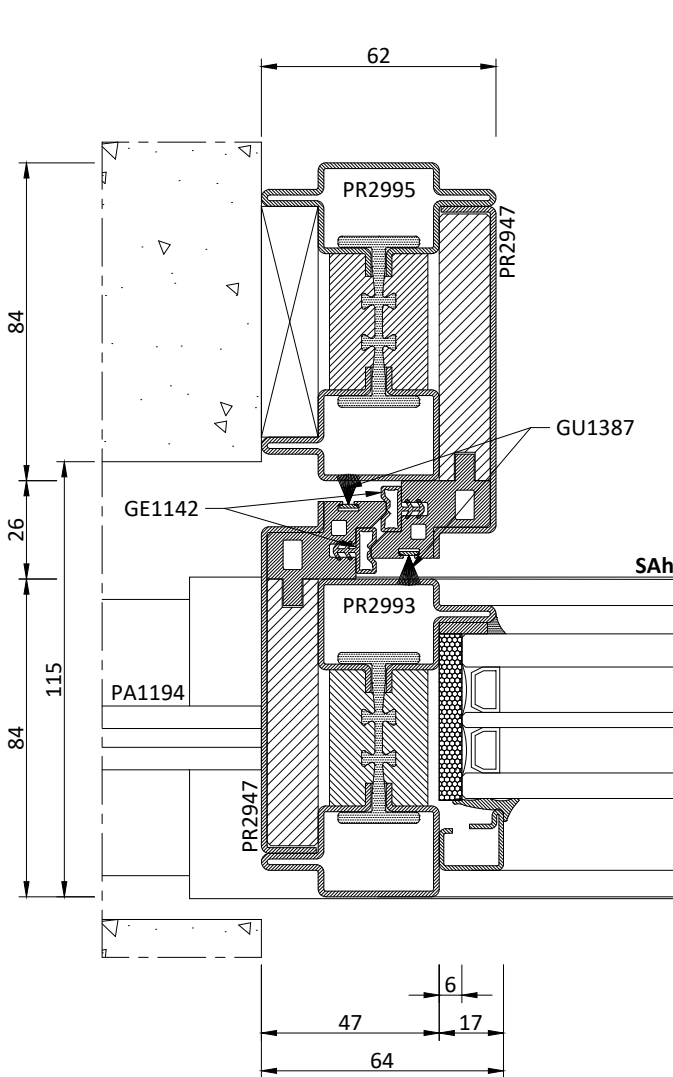
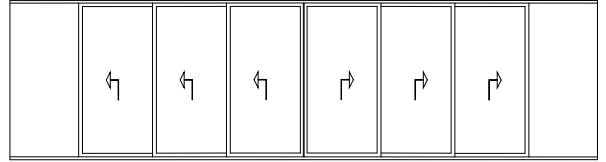

Schema | Type S1

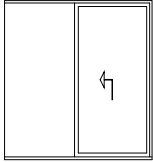

Schema | Type S2

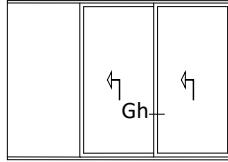

Schema | Type S3

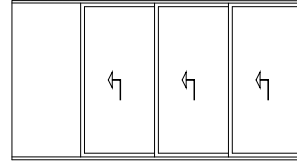

Schema | Type T1

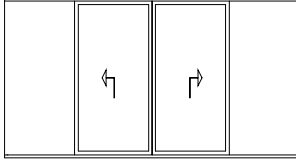

Schema | Type T2

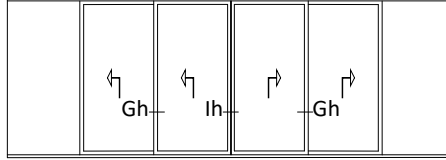

Schema | Type T3

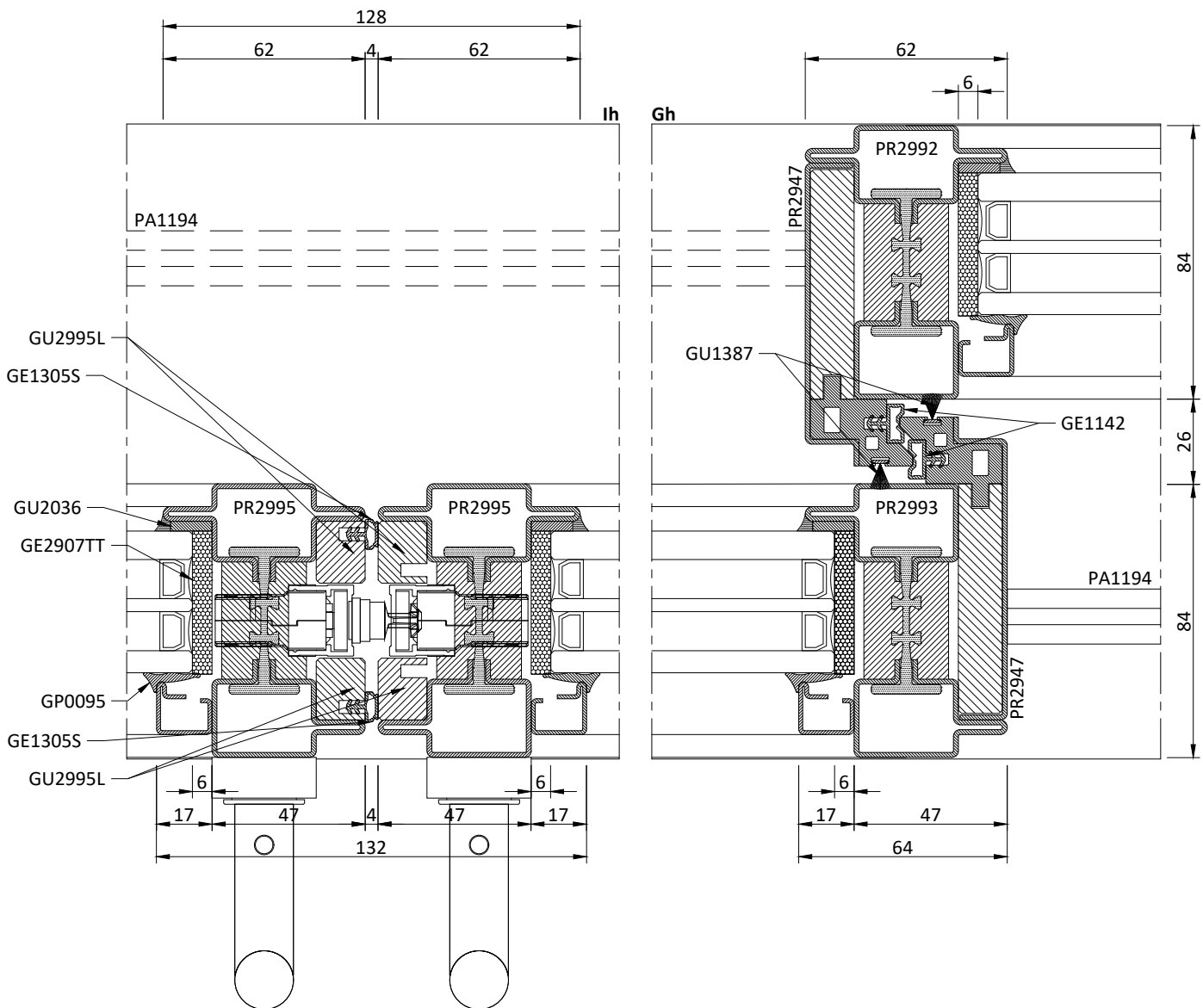
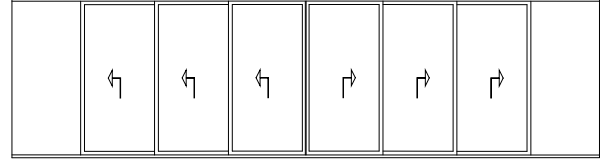

Schema | Type S1

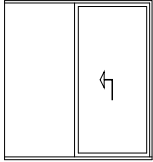

Schema | Type S2

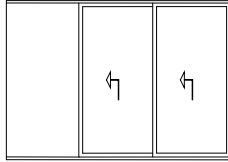

Schema | Type S3

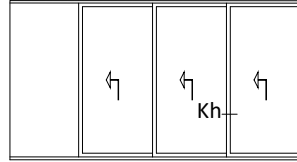

Schema | Type T1

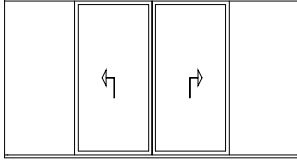

Schema | Type T2

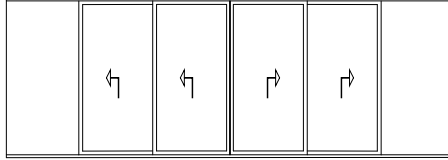

Schema | Type T3

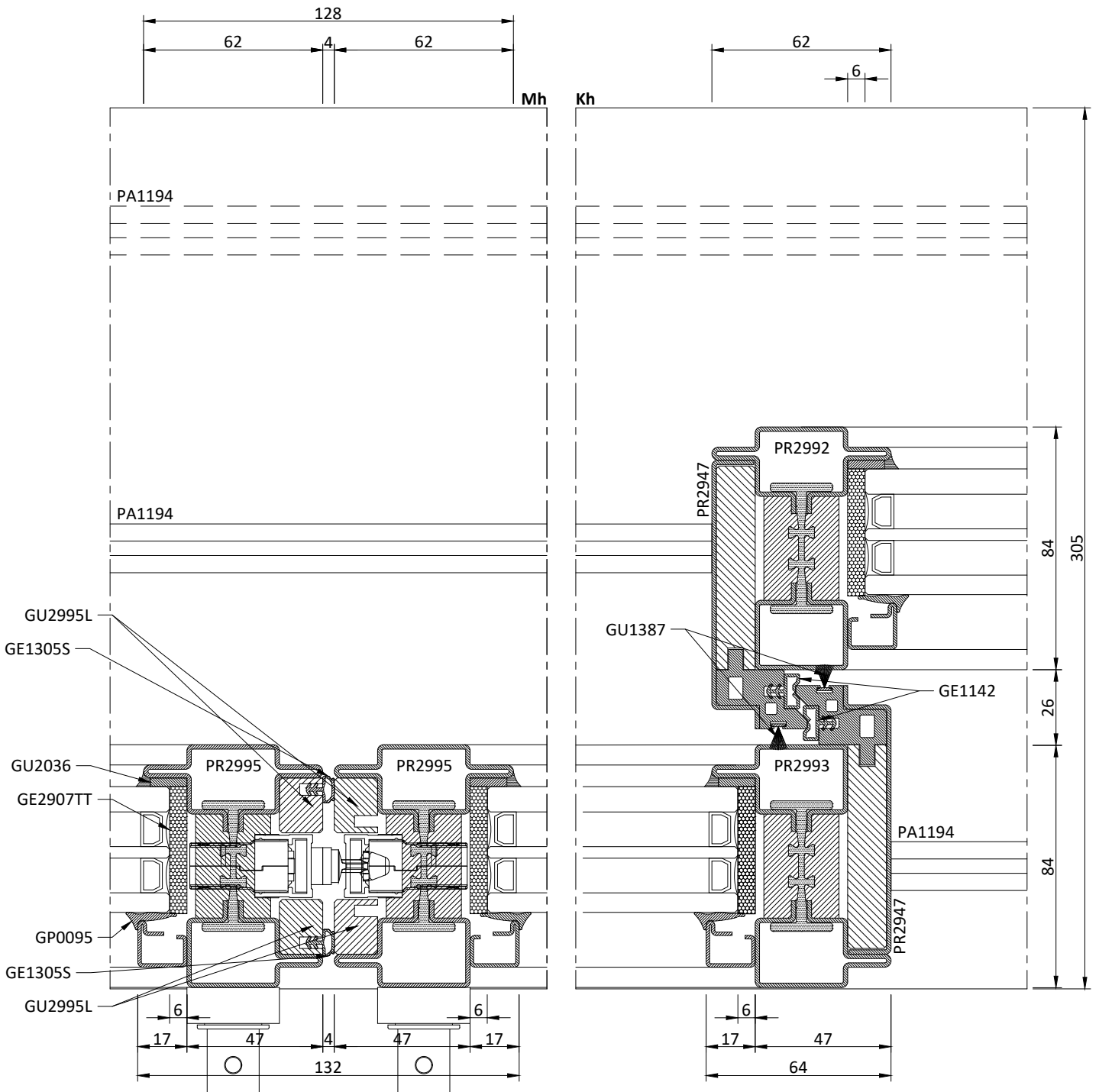
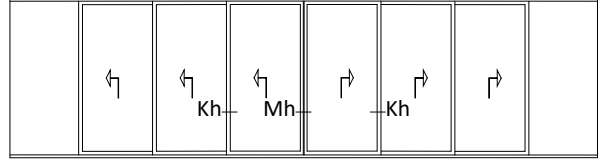

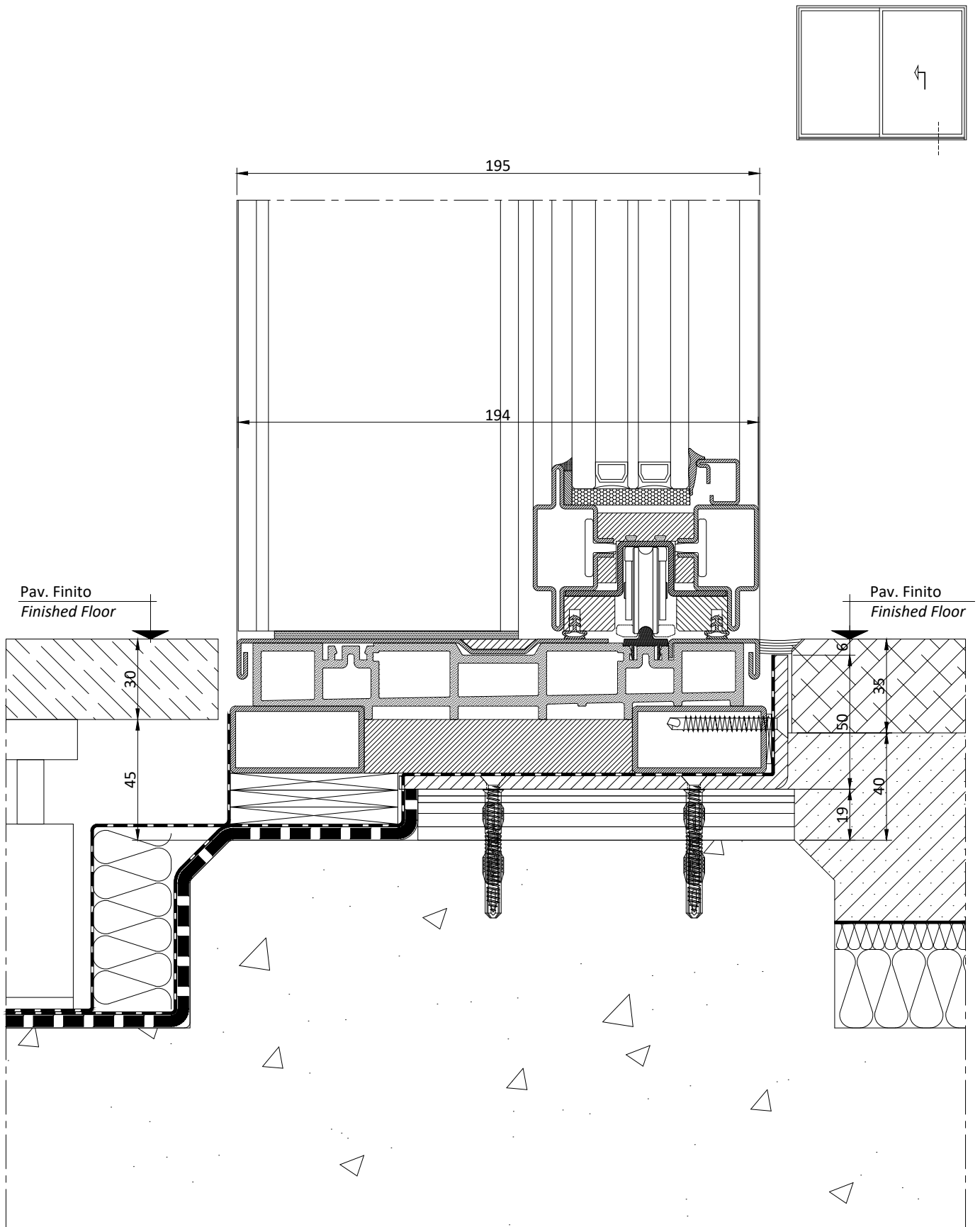

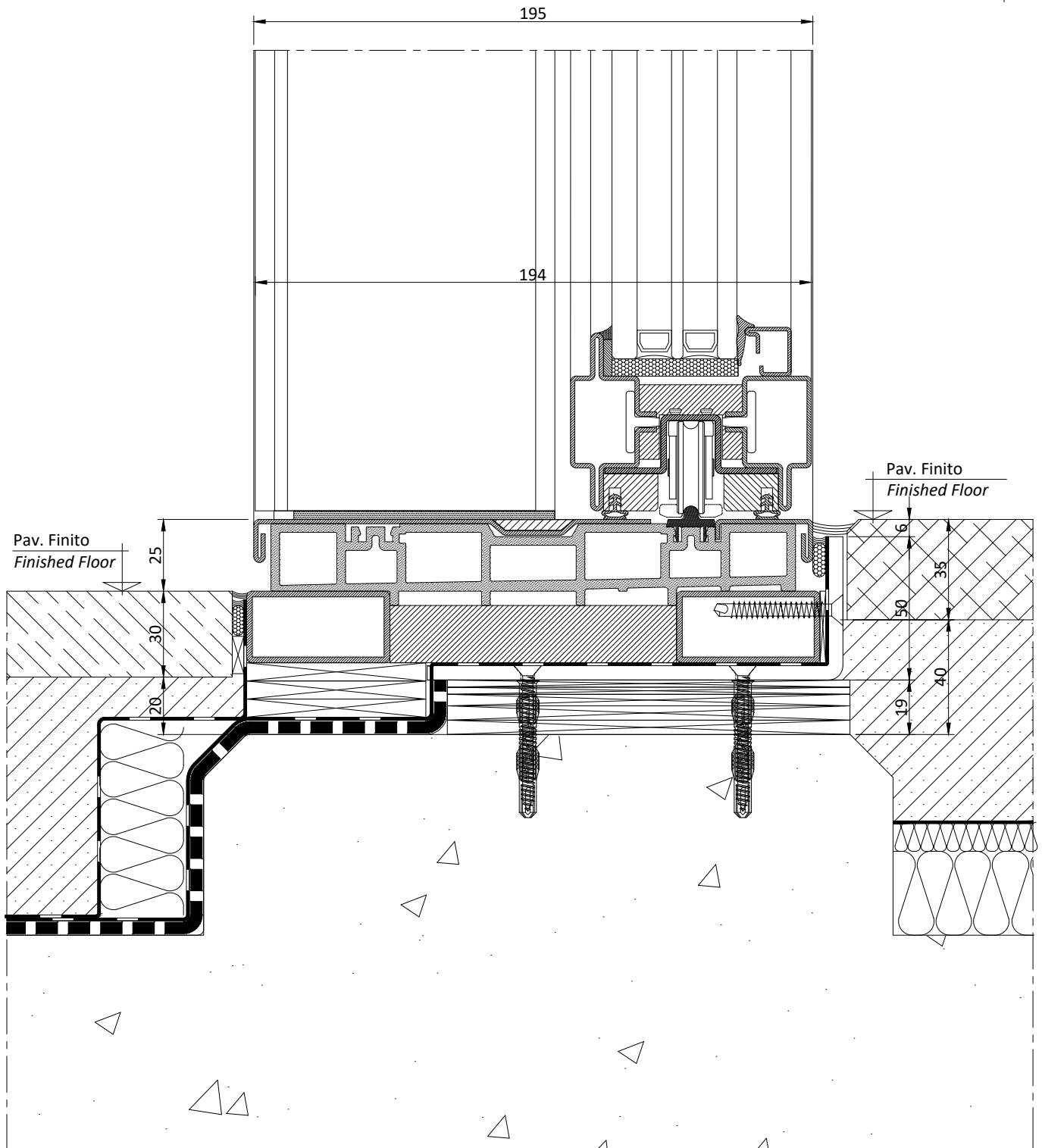
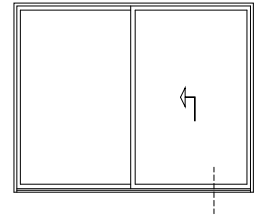



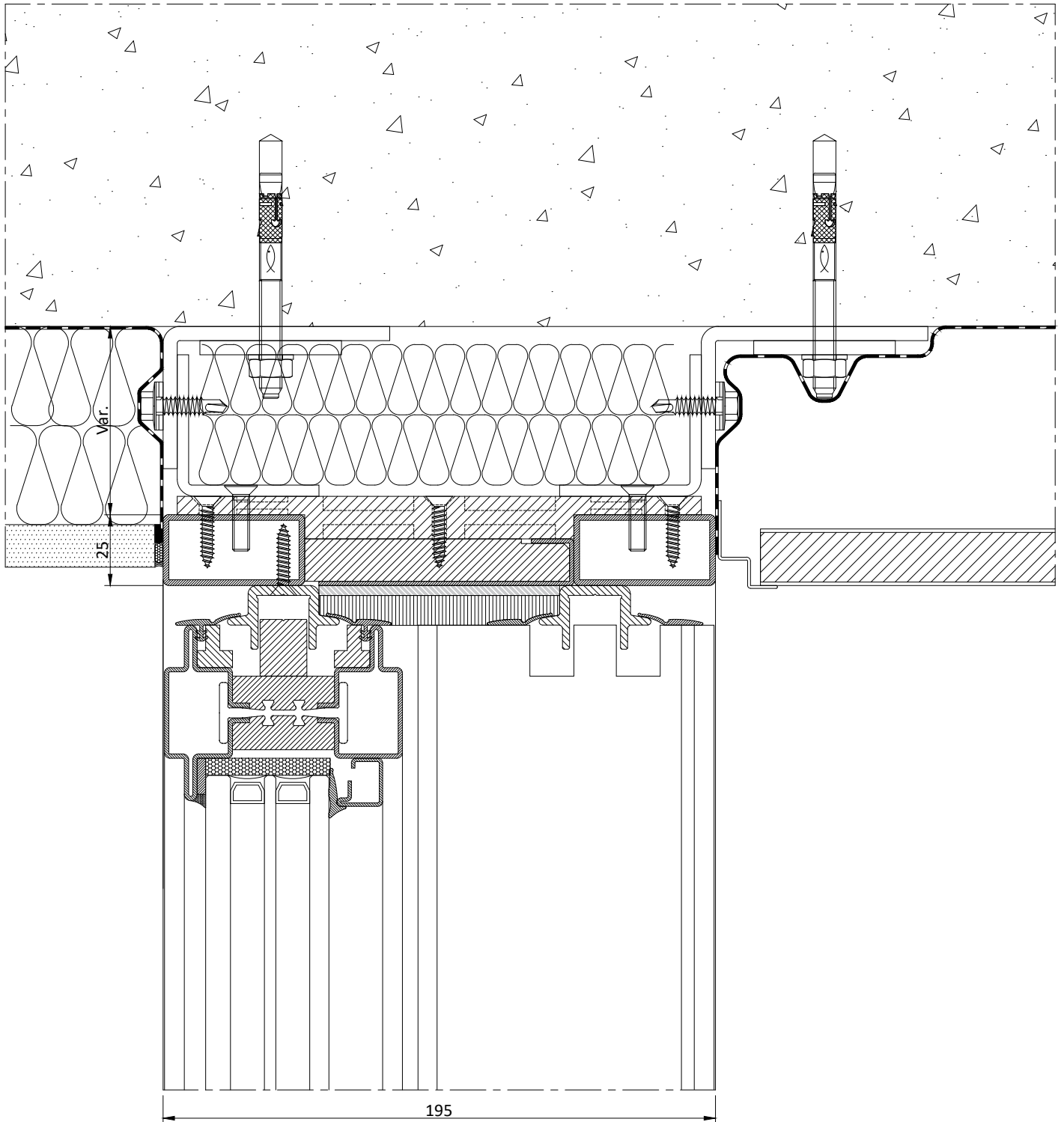
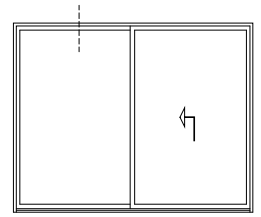

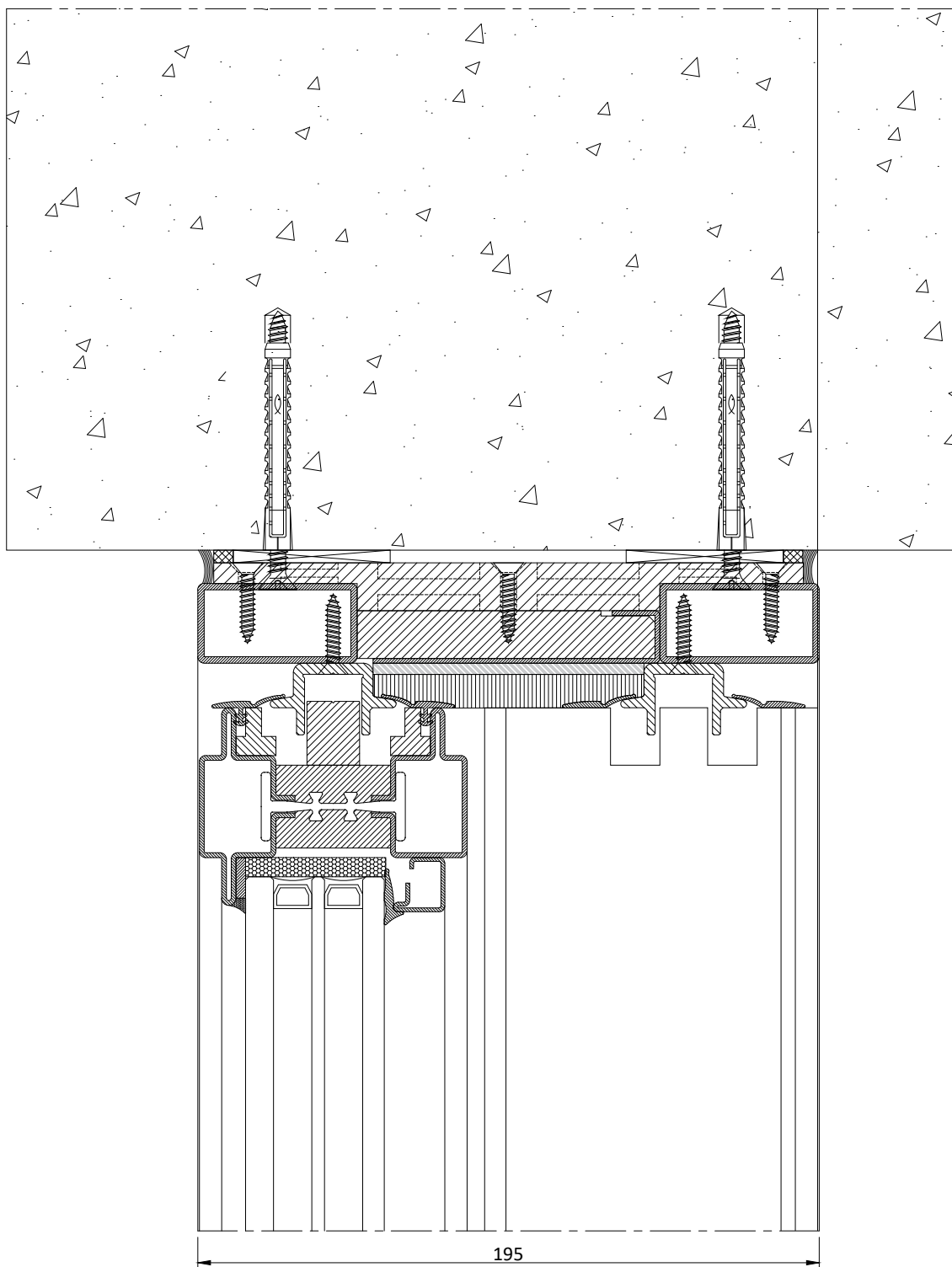
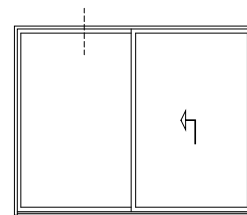

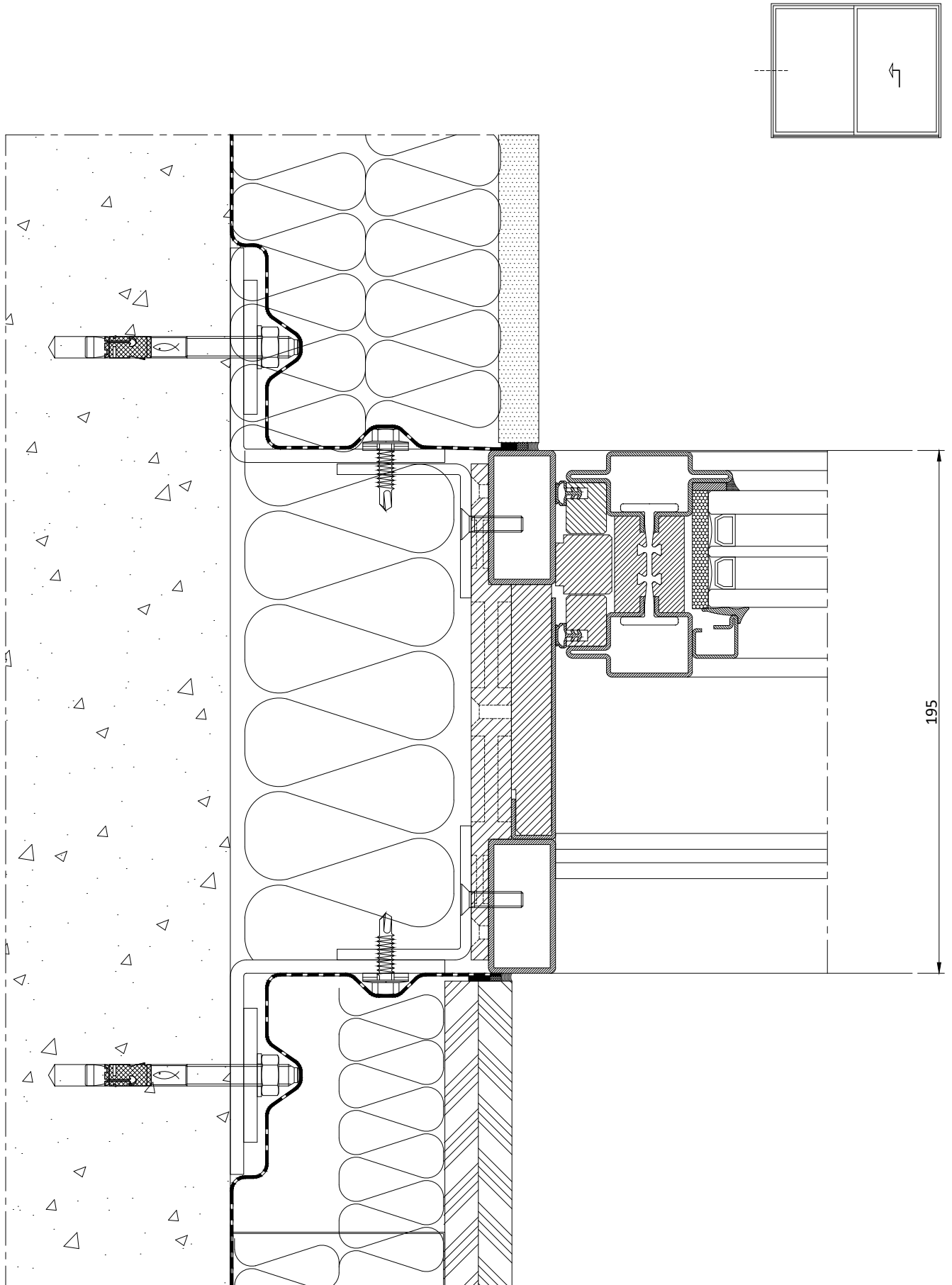

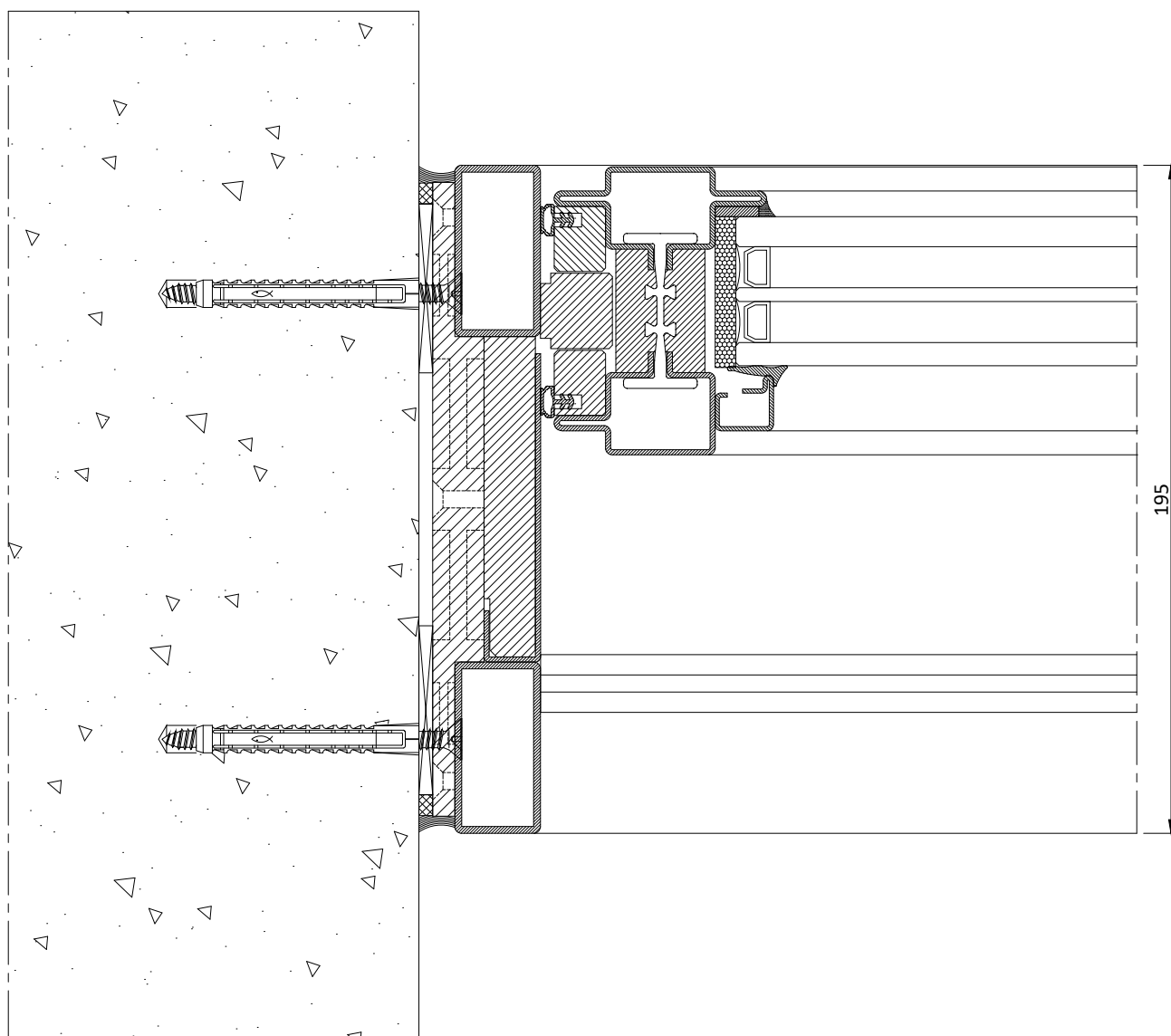
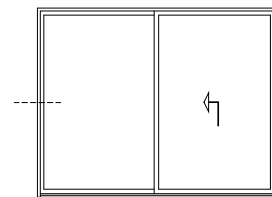

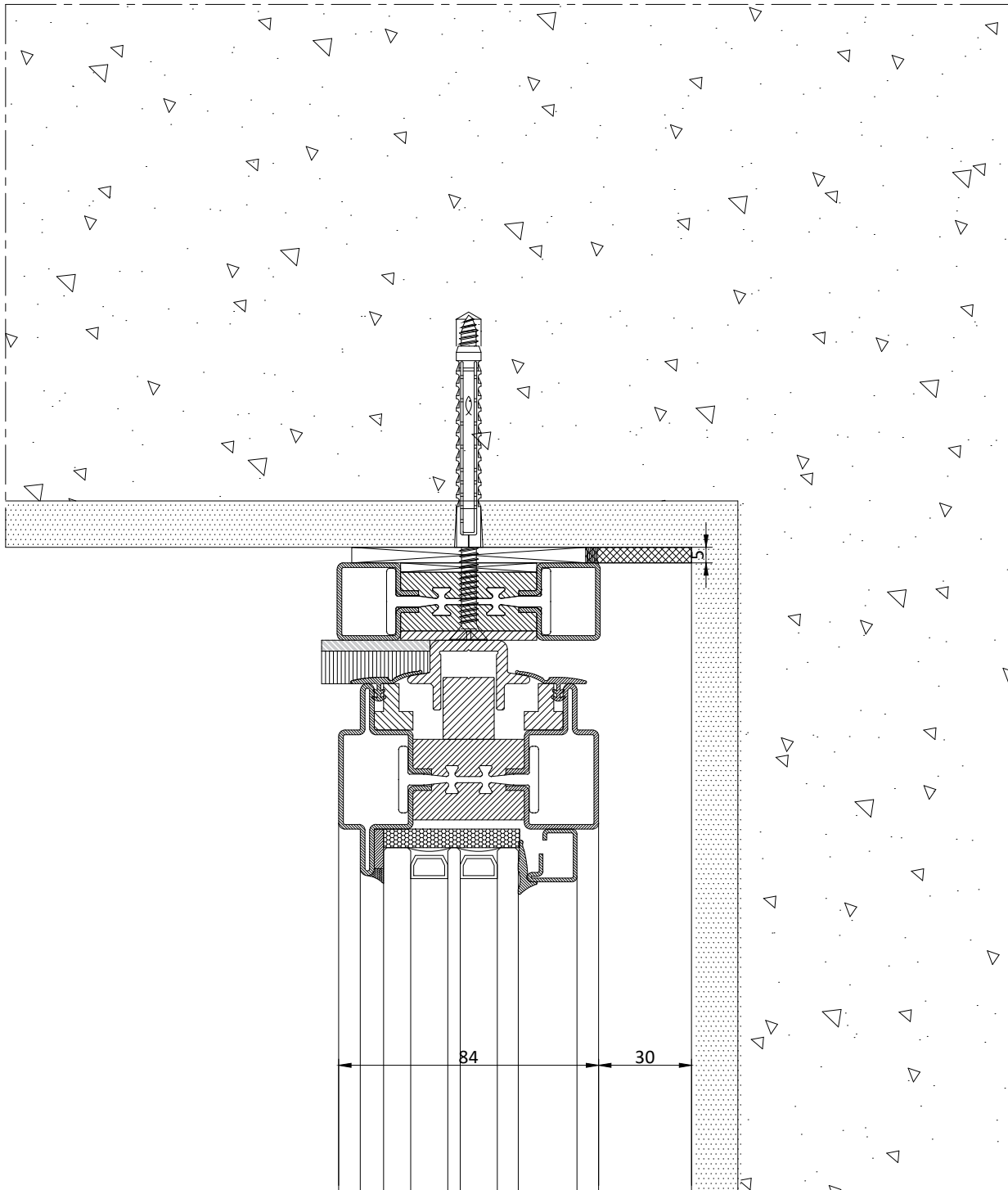
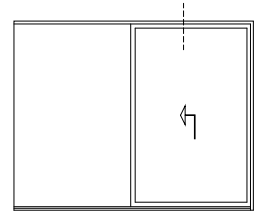

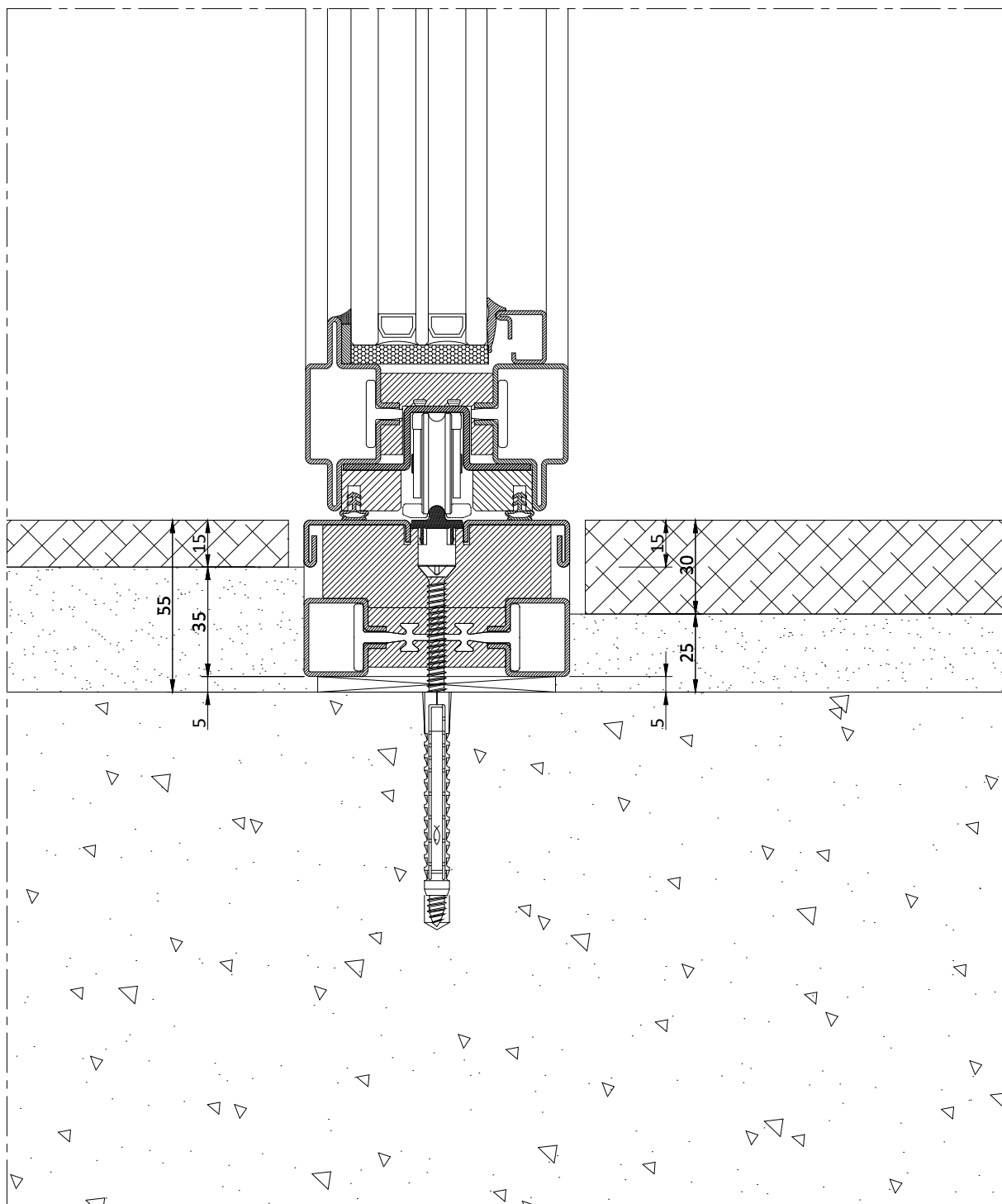
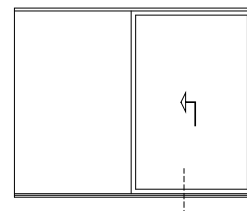

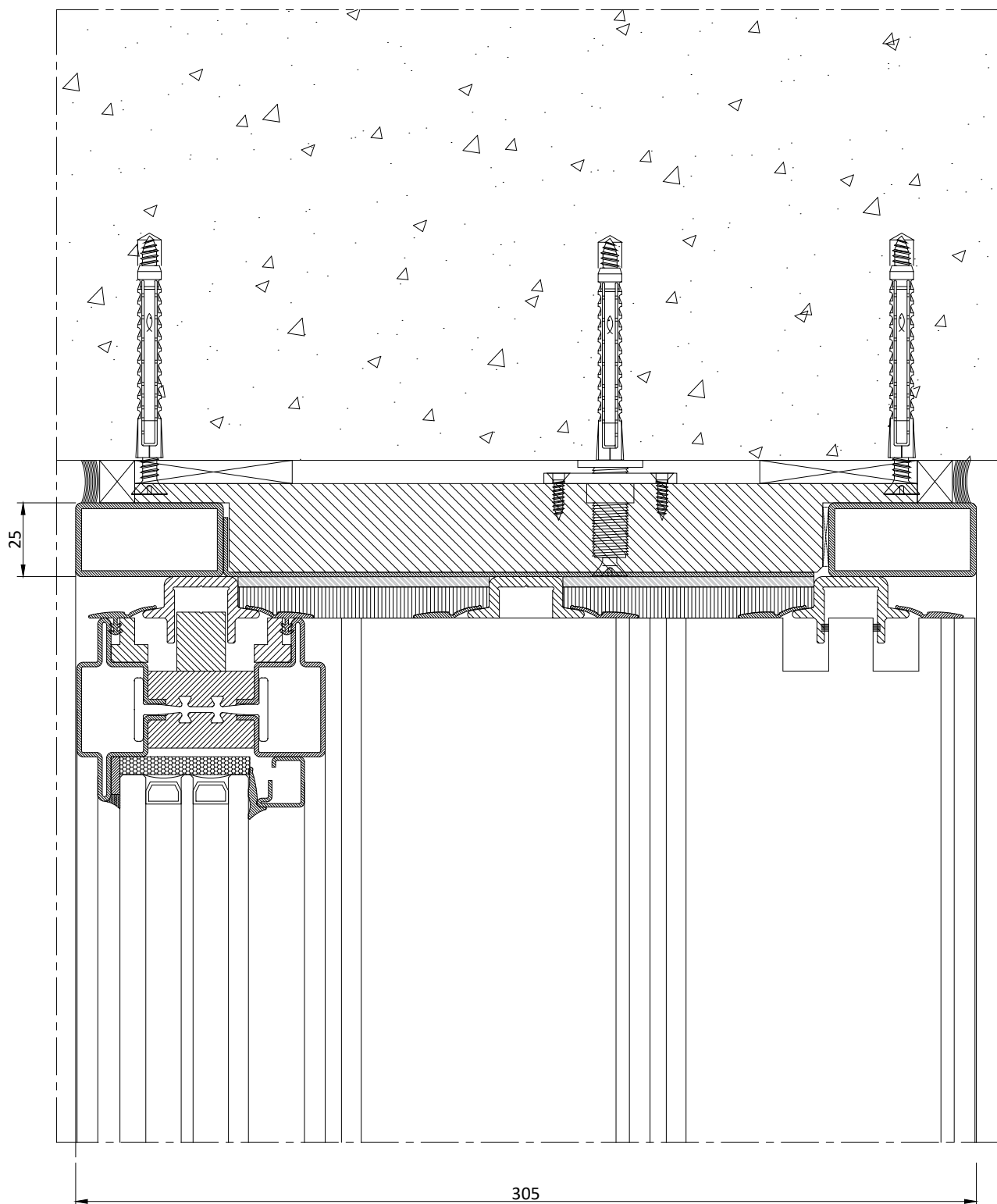
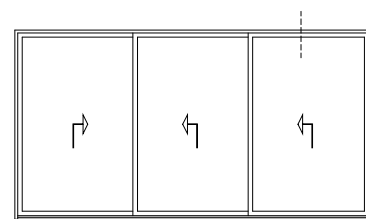

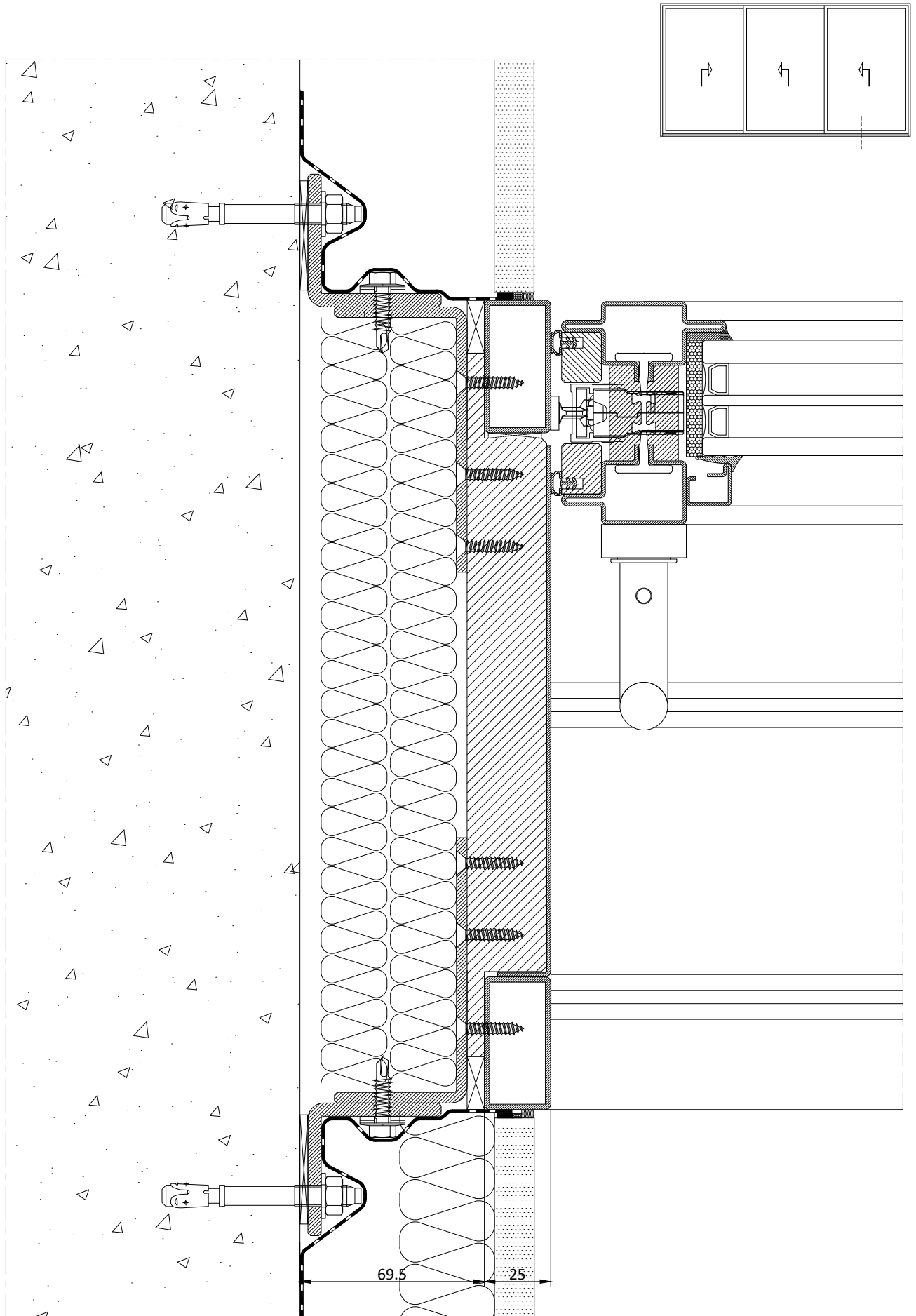



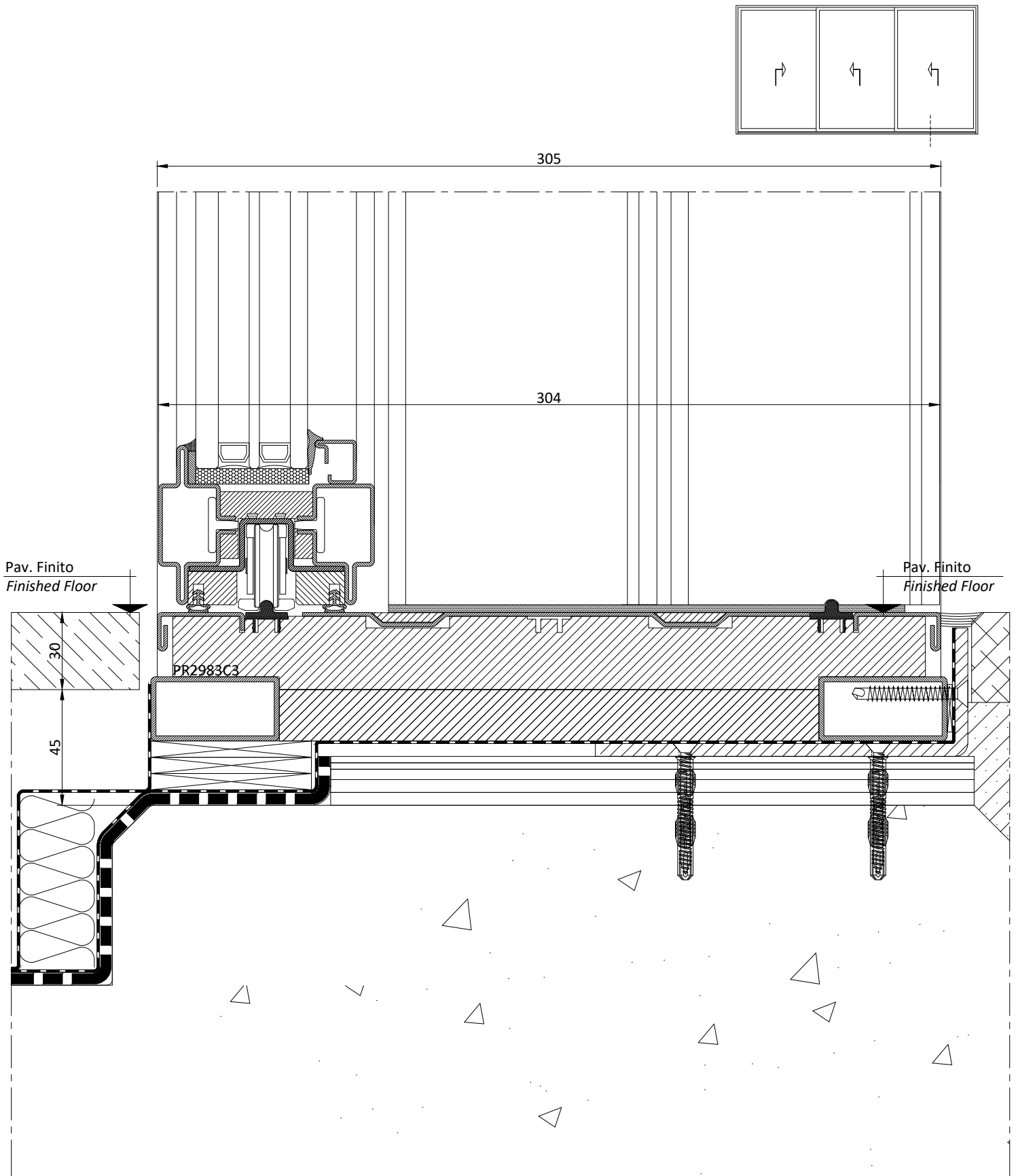

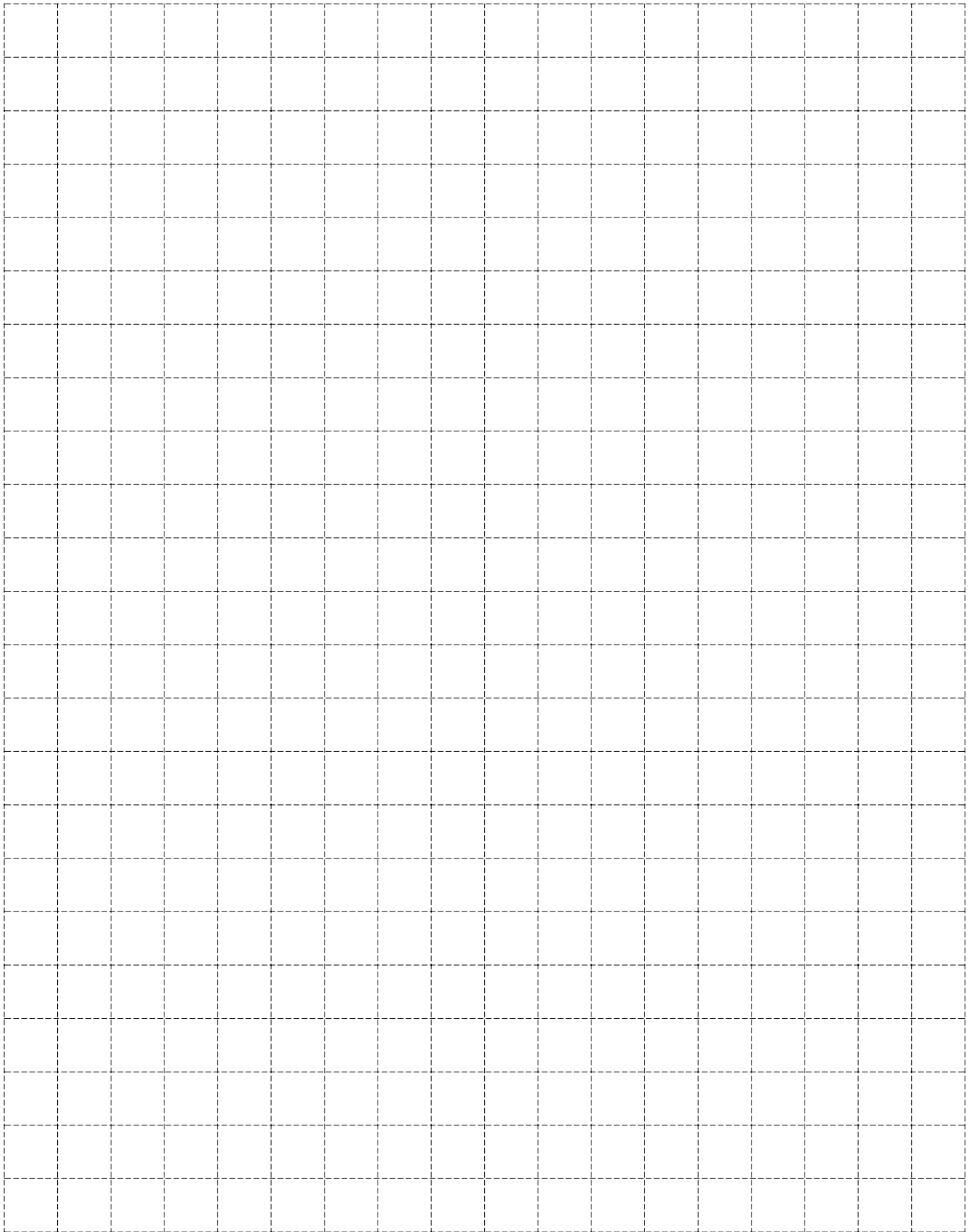

**Distinta di taglio e lista componenti | Cutting list and components list**

Le distinte di taglio e le liste accessori individuate per le diverse tipologie sono state redatte per un serramento tipo. E' compito dei tecnici specializzati delle ditte produttrici analizzare criticamente tali indicazioni al fine di verificare la compatibilità del tipo e numero di accessori previsti con il serramento oggetto della commessa reale.

*The cutting and hardware lists, which have been identified for the different typologies, have been produced for a standard window. The window manufacturers' specialized technicians will have to critically analyze such information in order to verify the compatibility of both the type and the number of accessories provided with the window object of the real order.*

Schema | Type A

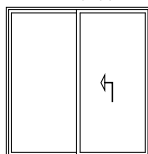

Schema | Type A3

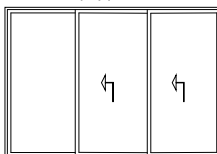

Schema | Type B

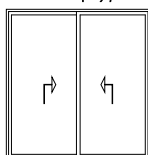

Schema | Type B3

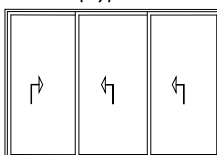

Schema | Type C

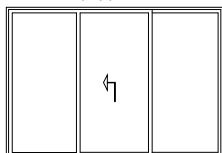

Schema | Type C3

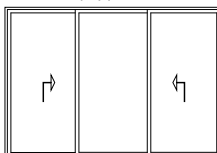

Schema | Type E

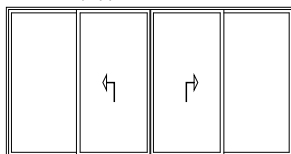

Schema | Type E3

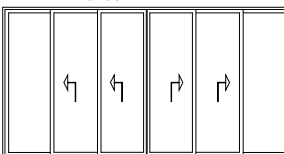

Schema | Type F

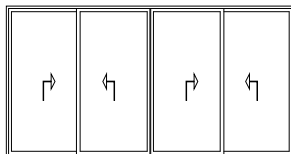

Schema | Type F3

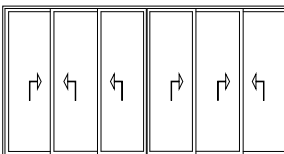

Schema | Type S1

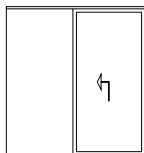

Schema | Type T1

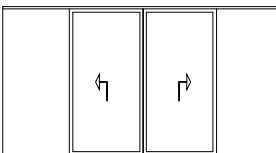

Schema | Type S2

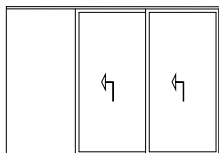

Schema | Type T2

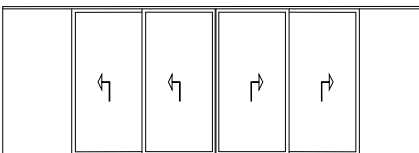

Schema | Type S3

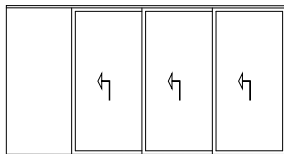

Schema | Type T3

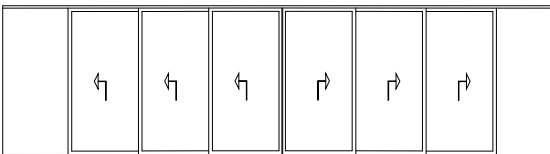

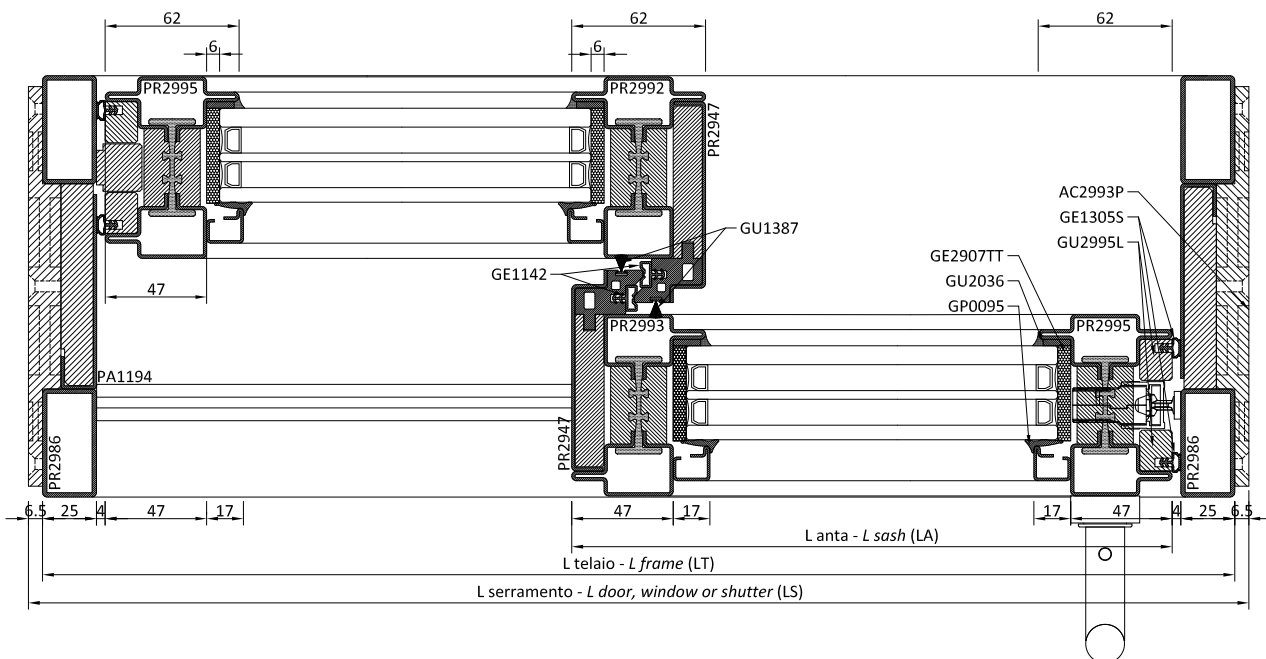
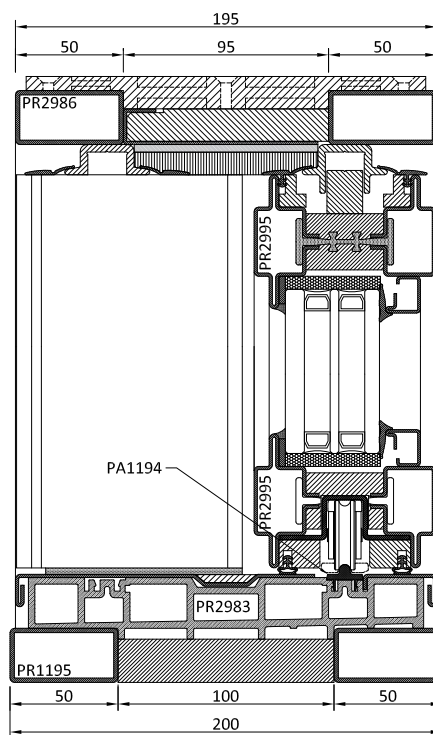
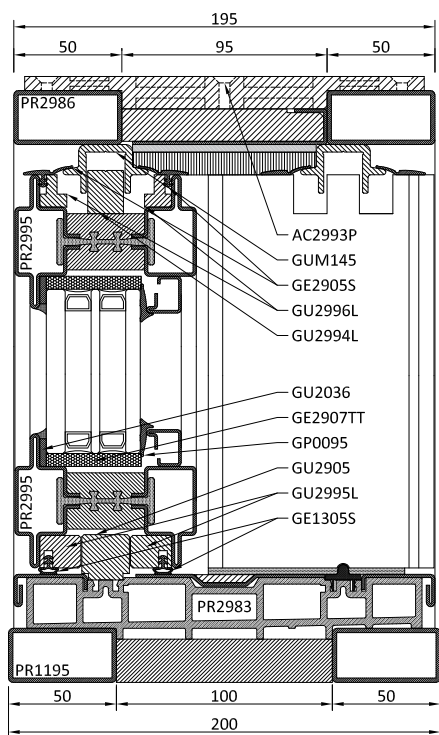
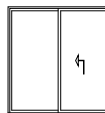

Cod.	PROFILI Descrizione	PROFILES Description	n°	Dim.	Taglio/Cutting
	<b>Telaio</b>	<b>Frame</b>			
PR2986	Profilo 50x25	Profile 50x25	2	LT	90 90
	Profilo 50x25	Profile 50x25	4	HT-25	90 90
	Profilo plastico	Plastic profile	2	LT/2	90 90
	Profilo plastico	Plastic profile	2	HT-25	90 90
	Profilo centrale a "C"	"C" profile	2	LT/2-3	90 90
	Profilo centrale a "C"	"C" profile	2	HT-25	90 90
PR1195	Tubo in acciaio 50x25 mm	50x25 mm steel tube	2	LT-50	90 90
	Estruso centrale di unione	Central extrusion junction	1	LT-50	90 90
PR2983	Telaio base - copertina esterna (Part. A)	Lower frame - external cover (Detail A)	1	LT/2-25	90 90
	Telaio base - copertina interna (Part. A)	Lower frame - internal cover (Detail A)	1	LT-50	90 90
	Telaio base - copertina centrale (Part. B)	Lower frame - central cover (Detail B)	1	LT/2-53	90 90
	Telaio base - copertina esterna (Part. C)	Lower frame - external cover (Detail C)	1	LT/2-25	90 90
	Telaio base - profilo poliammide di supporto guide	Lower frame - polyamide profile of rails	1	LT-50	90 90
	<b>Guide</b>	<b>Rail</b>			
GUM145	Profilo guida superiore anta mobile	Upper rail of sliding sash	1	LT-50	90 90
	Profilo guida superiore anta fissa	Upper rail of fixed sash	1	LT/2+3	90 90
PA1194	Profilo guida inferiore	Lower profile	1	LT-50	90 90
	<b>Anta</b>	<b>Sash</b>			
PR2995	Profilo zoccolo	Bottom rail profile	4	LT/2+2	45 45
	Profilo zoccolo	Bottom rail profile	2	HT-92	45 45
PR2992	Profilo a "T"	"T" profile	1	HT-92	45 45
PR2993	Profilo a "Z"	"Z" profile	1	HT-92	45 45
PR2947	Profilo labirinto centrale - anta mobile (Part. 1)	Central labyrinth profile - sliding sash (Detail 1)	1	HT-92	90 90
	Profilo labirinto centrale - anta mobile (Part. 2-3)	Central labyrinth profile - sliding sash (Detail 2)	1	HT-132	90 90
	Profilo labirinto centrale - anta fissa (Part. 1)	Central labyrinth profile - sliding sash (Detail 1)	1	HT-92	90 90
	Profilo labirinto centrale - anta fissa (Part. 2-3)	Central labyrinth profile - sliding sash (Detail 2)	1	HT-132	90 90
GU2995L	Profilo plastico porta guarnizione perimetrale	Plastic profile for rebate gasket support	4	HT-92	45 45
	Profilo plastico porta guarnizione perimetrale	Plastic profile for rebate gasket support	2	LT/2-13	45 90
	Profilo plastico porta guarnizione perimetrale	Plastic profile for rebate gasket support	2	LT/2-13	90 45
GU2996L	Profilo plastico porta guarnizione superiore	Plastic profile for rebate gasket support	2	LT/2-13	90 45
	Profilo plastico porta guarnizione superiore	Plastic profile for rebate gasket support	2	LT/2-13	45 90
GU2994L	Pattino di scorrimento anta mobile e fissa	Runner for sliding and fixed sash	2	LT/2-3	90 90
GU2905	Estruso di compensazione	Compensation extrusion	1	HT-107	90 90
	Estruso di compensazione	Compensation extrusion	1	LT/2-78	90 90
	<b>Fermavetri</b>	<b>Glazing beads</b>			
PR2606	Profilo fermavetro	Glazing bead profile	4	LT/2-92	45 45
	Profilo fermavetro	Glazing bead profile	4	HT-186	45 45
	<b>Vetri</b>	<b>Glass unit</b>			
	Vetrocamera	Double glazing	2	(LT/2-104) x (HT-198)	
	<b>ACCESSORI</b>	<b>HARDWARE</b>			
Cod.	Descrizione	Description	n°	Note/Notes	
AC2995R.xx	Kit piastrine di giunzione telaio esterno PR2986	Kit of external frame junction plates PR2986	4		
AC2993P	Accessorio assiemaggio telaio	Frame assemblage accessory	var.		
CV5403I	Rondella in acciaio inox/epdm	Stainless steel/vulcanised epdm washer	var.		
AG2992L.AB	Rostro aggiuntivo	Additional hook bolt	opz.		
AG2996J7A.xx	Kit alzante scorrevole	Lift and slide kit	1		
ACV__	Maniglione	Large handle	1		
AC2995.1	Kit squadrette di giunzione ante	Corner joint kit Sashes	2		
AG2989L.AB	Prolunga superiore cremonese	Upper cremonese extention	opz.	>2908	
AG2989C	Profilo di copertura aggiuntivo	Additional covering profile	opz.	>2908	
AC1305G	Angolo vulcanizzato per GE1305S	Vulcanised corner gasket for GE1305S	4		
AC2608AR	Clips fissaggio fermavetri	Clips for glazing bead	var.		
	<b>GUARNIZIONI*</b>	<b>GASKETS*</b>			
Cod.	Descrizione	Description	n°	Dim.	
GU2036	Piattina adesiva morbida esterno vetro	Soft adhesive shim for external window	1	2xLT + 4xHT	
GU2907TT	Guarnizione sotto vetro	Under glass gasket	1	2xLT + 4xHT	
GP0095	Guarnizione interna vetro	Internal glass gasket	1	2xLT + 4xHT	
GE2905S	Guarnizione superiore ante	Gasket for upper sash	1	2xLT	
GE1305S	Guarnizione perimetrale ante	Gasket for side sash	1	2xLT + 4xHT	
GE1142	Guarnizione labirinto centrale	Gasket for central labyrinth	1	2xHT	
GU1387	Spazzolino verticale labirinto	Vertical labyrinth brush + adhesive	1	2xHT	
* le dimensioni delle guarnizioni sono indicative e devono essere aumentate del 10% per adattamenti e ritiri del materiale nel tempo					
* the gasket dimensions are indicative and have to be increased by 10% owing to adaptation and contractions of the material over time					

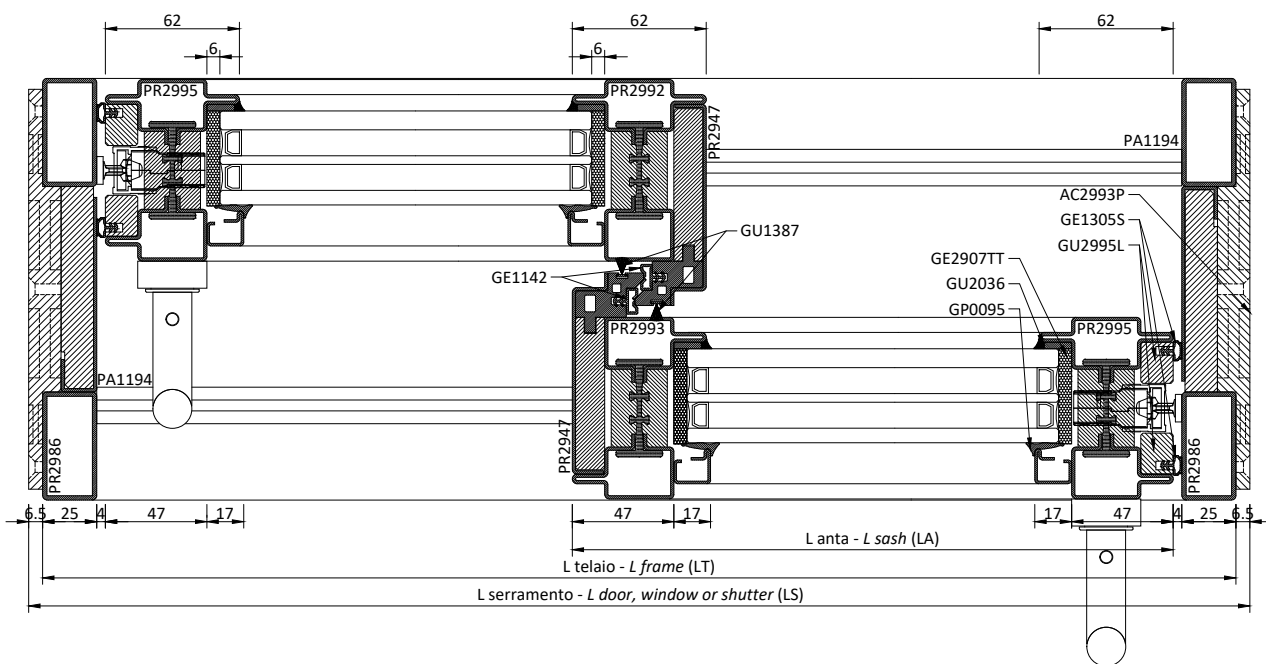
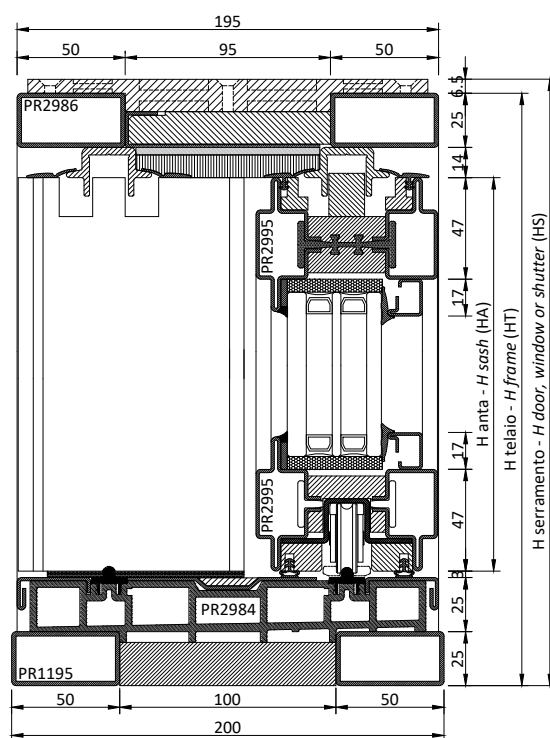
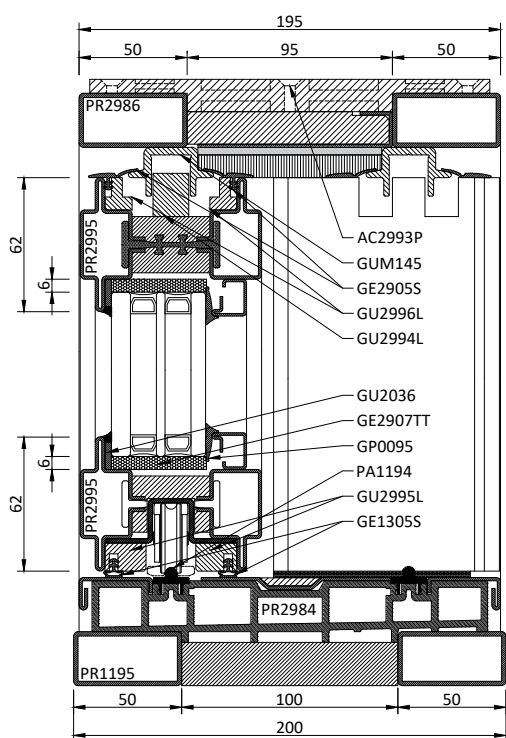
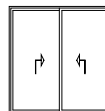

PROFILI		PROFILES			
Cod.	Descrizione	Description	n°	Dim.	Taglio/Cutting
<b>Telaio</b> <b>Frame</b>					
PR2986	Profilo 50x25	Profile 50x25	2	LT	90 90
	Profilo 50x25	Profile 50x25	4	HT-25	90 90
	Profilo plastico	Plastic profile	2	LT/2	90 90
	Profilo plastico	Plastic profile	2	HT-25	90 90
	Profilo centrale a "C"	"C" profile	2	LT/2-3	90 90
	Profilo centrale a "C"	"C" profile	2	HT-25	90 90
PR1195	Tubo in acciaio 50x25 mm	50x25 mm steel tube	2	LT-50	90 90
	Profilo plastico	Plastic profile	1	LT-50	90 90
PR2984	Telaio base - copertina interna (Part. A)	Lower frame - internal cover (Detail A)	2	LT-50	90 90
	Telaio base - copertina centrale (Part. B)	Lower frame - central cover (Detail B)	2	LT/2-53	90 90
	Telaio base - profilo poliammide di supporto guide	Lower frame - polyamide profile of rails	1	LT-50	90 90
<b>Guide</b> <b>Rail</b>					
GUM145	Profilo guida superiore anta mobile	Upper rail of sliding sash	2	LT-50	90 90
PA1194	Profilo guida inferiore	Lower profile	2	LT-50	90 90
<b>Anta</b> <b>Sash</b>					
PR2995	Profilo zoccolo	Bottom rail profile	4	LT/2+2	45 45
	Profilo zoccolo	Bottom rail profile	2	HT-92	45 45
PR2992	Profilo a "T"	"T" profile	1	HT-92	45 45
PR2993	Profilo a "Z"	"Z" profile	1	HT-92	45 45
PR2947	Profilo labirinto centrale - anta mobile (Part. 1)	Central labyrinth profile - sliding sash (Detail 1)	2	HT-92	90 90
	Profilo labirinto centrale - anta mobile (Part. 2-3)	Central labyrinth profile - sliding sash (Detail 2)	2	HT-132	90 90
GU2995L	Profilo plastico porta guarnizione perimetrale	Plastic door profile for rebate gasket support	4	HT-92	45 45
	Profilo plastico porta guarnizione perimetrale	Plastic door profile for rebate gasket support	2	LT/2-13	45 90
	Profilo plastico porta guarnizione perimetrale	Plastic door profile for rebate gasket support	2	LT/2-13	90 45
GU2996L	Profilo plastico porta guarnizione superiore	Plastic door profile for rebate gasket support	2	LT/2-13	90 45
	Profilo plastico porta guarnizione superiore	Plastic door profile for rebate gasket support	2	LT/2-13	45 90
GU2994L	Pattino di scorrimento anta mobile e fissa	Runner for sliding and fixed sash	2	LT/2-3	90 90
<b>Fermavetri</b> <b>Glazing beads</b>					
PR2606	Profilo fermavetro	Glazing bead profile	4	LT/2-92	45 45
	Profilo fermavetro	Glazing bead profile	4	HT-186	45 45
<b>Vetri</b> <b>Glass unit</b>					
	Vetrocamera	Double glazing	2	(LT/2-104) x (HT-198)	
<b>ACCESSORI</b> <b>HARDWARE</b>					
Cod.	Descrizione	Description	n°	Note/Notes	
AC2995R.xx	Kit piastrine di giunzione telaio esterno PR2986	Kit of external frame junction plates PR2986	4		
AC2993P	Accessorio assiemaggio telaio	Frame assemblage accessory	var.		
CV5403I	Rondella in acciaio inox/apdm	Stainless steel/vulcanised epdm washer	var.		
AG2992L.AB	Rostro aggiuntivo	Additional hook bolt	opz.		
AG2996J7B.xx	Kit alzante scorrevole	Lift and slide kit	1		
ACV	Maniglione	Large handle	2		
AC2995.1	Kit squadrette di giunzione ante	Corner joint kit Sashes	2		
AG2989L.AB	Prolunga superiore cremonese	Upper cremonese extension	1	> 2908	
AG2989C	Profilo di copertura aggiuntivo	Additional covering profile	1	> 2908	
AC1305G	Angolo vulcanizzato per GE1305S	Vulcanised corner gasket for GE1305S	4		
AC2608AR	Clips fissaggio fermavetri	Clips for glazing bead	var.		
<b>GUARNIZIONI*</b> <b>GASKETS*</b>					
Cod.	Descrizione	Description	n°	Dim.	
GU2036	Piattina adesiva morbida esterno vetro	Soft adhesive shim for external window	1	2xLT+4xHT	
GU2907TT	Guarnizione sotto vetro	Under glass gasket	1	2xLT+4xHT	
GP0095	Guarnizione interna vetro	Internal glass gasket	1	2xLT+4xHT	
GE2905S	Guarnizione superiore ante	Gasket for upper sash	1	2xLT	
GE1305S	Guarnizione perimetrale ante	Gasket for side sash	1	2xLT+4xHT	
GE1142	Guarnizione labirinto centrale	Gasket for central labyrinth	1	2xHT	
GU1387	Spazzolino verticale labirinto	Vertical labyrinth brush + adhesive	1	2xHT	

\* Le dimensioni delle guarnizioni sono indicative e devono essere aumentate del 10% per adattamenti e ritiri del materiale nel tempo

\* the gasket dimensions are indicative and have to be increased by 10% owing to adaptation and contractions of the material over time

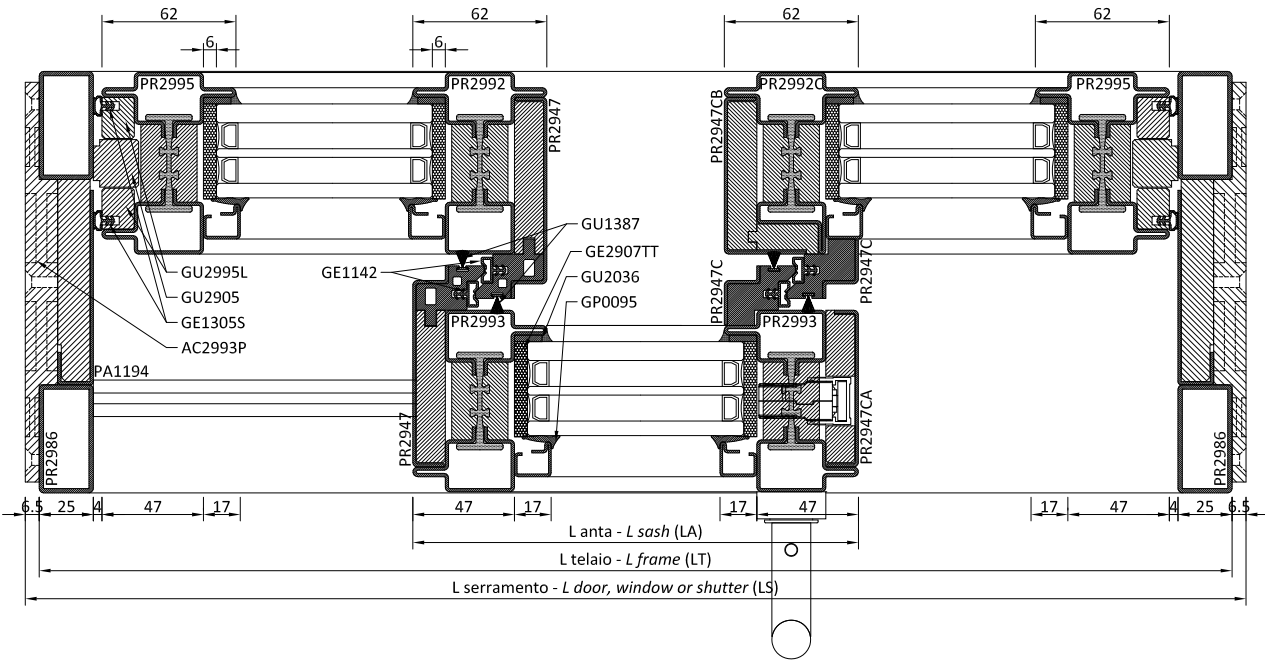
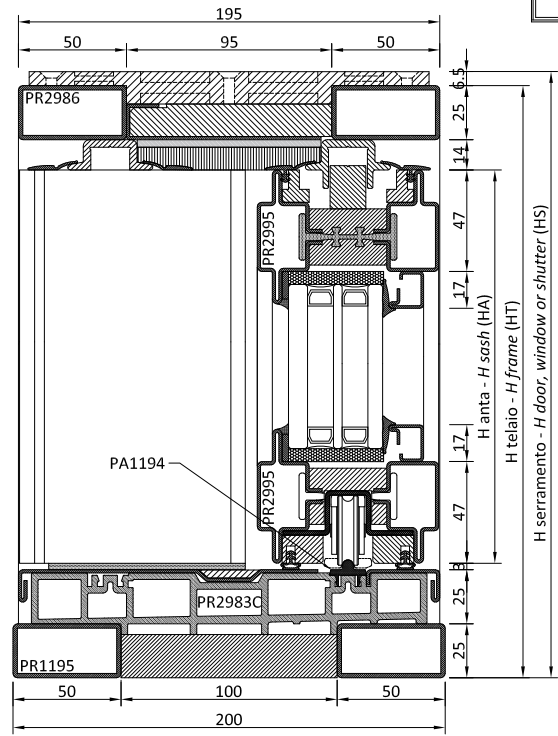
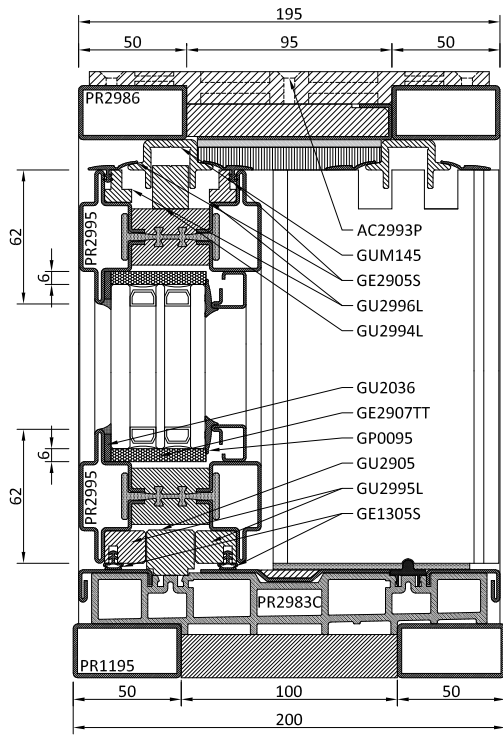
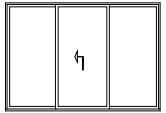



PROFILI		PROFILES			
Cod.	Descrizione	Description	n°	Dim.	Taglio/Cutting
<b>Telaio</b>					
<b>Frame</b>					
PR2986	Profilo 50x25	Profile 50x25	2	LT	90 90
	Profilo 50x25	Profile 50x25	4	HT-25	90 90
	Profilo plastico	Plastic profile	2	LT/3+20	90 90
	Profilo plastico	Plastic profile	1	LT/3-40	90 90
	Profilo plastico	Plastic profile	2	HT-25	90 90
	Profilo centrale a "C"	"C" profile	2	LT/3+17	90 90
	Profilo centrale a "C"	"C" profile	1	LT/3-45	90 90
PR1195	Tubo in acciaio 50x25 mm	50x25 mm steel tube	2	LT-50	90 90
	Profilo plastico	Plastic profile	1	LT-50	90 90
PR2983C	Telaio base - copertina esterna (Part. A)	Lower frame - external cover (Detail A)	2	LT/3-5	90 90
	Telaio base - copertina interna (Part. A)	Lower frame - internal cover (Detail A)	1	2LT/3-45	90 90
	Telaio base - copertina centrale (Part. B)	Lower frame - central cover (Detail B)	1	LT/3-33	90 90
	Telaio base - copertina esterna (Part. C)	Lower frame - external cover (Detail C)	1	LT/3-40	90 90
	Telaio base - copertina interna (Part. C)	Lower frame - internal cover (Detail C)	1	LT/3-5	90 90
	Telaio base - profilo poliammide di supporto guide	Lower frame - polyamide profile of rails	1	LT-50	90 90
<b>Guide</b>					
<b>Rail</b>					
GUM145	Profilo guida superiore ante mobile	Upper rail of sliding sash	1	LT-50	90 90
GUM145	Profilo guida superiore ante fissa	Upper rail of sliding sash	2	LT/3+23	90 90
PA1194	Profilo guida inferiore	Lower profile	1	2LT/3-45	90 90
<b>Anta</b>					
<b>Sash</b>					
PR2995	Profilo zoccolo	Bottom rail profile	6	LT/3+22	45 45
	Profilo zoccolo	Bottom rail profile	2	HT-92	45 45
PR2992	Profilo a "T"	"T" profile	2	HT-92	45 45
PR2993	Profilo a "Z"	"Z" profile	2	HT-92	45 45
PR2947	Profilo labirinto centrale - ante mobile (Part. 1)	Central labyrinth profile - sliding sash (Detail 1)	1	HT-92	90 90
	Profilo labirinto centrale - ante mobile (Part. 2-3)	Central labyrinth profile - sliding sash (Detail 2)	1	HT-132	90 90
	Profilo labirinto centrale - ante fissa (Part. 1)	Central labyrinth profile - sliding sash (Detail 1)	1	HT-92	90 90
	Profilo labirinto centrale - ante fissa (Part. 2-3)	Central labyrinth profile - sliding sash (Detail 2)	1	HT-132	90 90
PR2947CA	Profilo labirinto centrale - ante mobile (Part. 1)	Central labyrinth profile - sliding sash (Detail 1)	1	HT-92	90 90
	Profilo labirinto centrale - ante mobile (Part. 2-3)	Central labyrinth profile - sliding sash (Detail 2)	1	HT-132	90 90
PR2947CB	Profilo labirinto centrale - ante mobile (Part. 1)	Central labyrinth profile - sliding sash (Detail 1)	1	HT-92	90 90
	Profilo labirinto centrale - ante mobile (Part. 2)	Central labyrinth profile - sliding sash (Detail 2)	1	HT-132	90 90
PR2947C	Profilo labirinto centrale - ante mobile (Part. 1)	Central labyrinth profile - sliding sash (Detail 1)	2	HT-92	90 90
	Profilo labirinto centrale - ante mobile (Part. 2)	Central labyrinth profile - sliding sash (Detail 2)	2	HT-132	90 90
GU2995L	Profilo plastico porta guarnizione perimetrale	Plastic door profile for rebate gasket support	4	HT-92	45 45
	Profilo plastico porta guarnizione perimetrale	Plastic door profile for rebate gasket support	2	LT/3+7	45 90
	Profilo plastico porta guarnizione perimetrale	Plastic door profile for rebate gasket support	2	LT/3+7	90 45
	Profilo plastico porta guarnizione perimetrale	Plastic door profile for rebate gasket support	2	LT/3-8	90 90
GU2996L	Profilo plastico porta guarnizione superiore	Plastic door profile for rebate gasket support	2	LT/3+7	90 45
	Profilo plastico porta guarnizione superiore	Plastic door profile for rebate gasket support	2	LT/3+7	45 90
	Profilo plastico porta guarnizione superiore	Plastic door profile for rebate gasket support	2	LT/3-8	90 90
GU2994L	Pattino di scorrimento ante mobile e fissa	Runner for sliding and fixed sash	3	LT/3+17	90 90
GU2905	Estruso di compensazione	Compensation extrusion	2	LT/3-11	90 90
	Estruso di compensazione	Compensation extrusion	2	HT-107	90 90
<b>Fermavetri</b>					
<b>Glazing beads</b>					
PR2606	Profilo fermavetro	Glazing bead profile	6	LT/3-72	45 45
	Profilo fermavetro	Glazing bead profile	6	HT-186	45 45
<b>Vetri</b>					
<b>Glass unit</b>					
	Vetrocamera	Double glazing	2	(LT/3-84)×(HT-198)	
<b>ACCESSORI</b>					
<b>HARDWARE</b>					
Cod.	Descrizione	Description	n°	Note/Notes	
AC2995R.xx	Kit piastrene di giunzione telaio esterno PR2986	Kit of external frame junction plates PR2986	4		
AC2993P	Accessorio assemblaggio telaio	Frame assembly accessory	var.		
CV5403I	Rondella in acciaio inox/epdm	Stainless steel/vulcanised epdm washer	var.		
AG2996/7C.xx	Kit alzante scorrevole	Lift and slide kit	1		
ACV__	Maniglione	Large handle	1		
AC2995.1	Kit squadrette di giunzione ante	Corner joint kit Sashes	1		
AC2995.2	Kit squadrette di giunzione ante	Corner joint kit Sashes	1		
AC2995.3	Kit squadrette di giunzione ante	Corner joint kit Sashes	1		
AC1305G	Angolo vulcanizzato per GE1305S	Vulcanised corner gasket for GE1305S	4		
AC2608AR	Clips fissaggio fermavetri	Clips for glazing bead	var.		
<b>GUARNIZIONI*</b>					
<b>GASKETS*</b>					
Cod.	Descrizione	Description	n°	Dim.	
GU2036	Piattina adesiva morbida esterno vetro	Soft adhesive shim for external window	1	2xLT+6xHT	
GU2907TT	Guarnizione sotto vetro	Under glass gasket	1	2xLT+6xHT	
GP0095	Guarnizione interna vetro	Internal glass gasket	1	2xLT+6xHT	
GE2905S	Guarnizione superiore ante	Gasket for upper sash	1	2xLT	
GE1305S	Guarnizione perimetrale ante	Gasket for side sash	1	2xLT+4xHT	
GE1142	Guarnizione labirinto centrale	Gasket for central labyrinth	1	4xHT	
GU1387	Spazzolino verticale labirinto	Vertical labyrinth brush + adhesive	1	4xHT	
* Le dimensioni delle guarnizioni sono indicative e devono essere aumentate del 10% per adattamenti e ritiri del materiale nel tempo					
* the gasket dimensions are indicative and have to be increased by 10% owing to adaptation and contractions of the material over time					

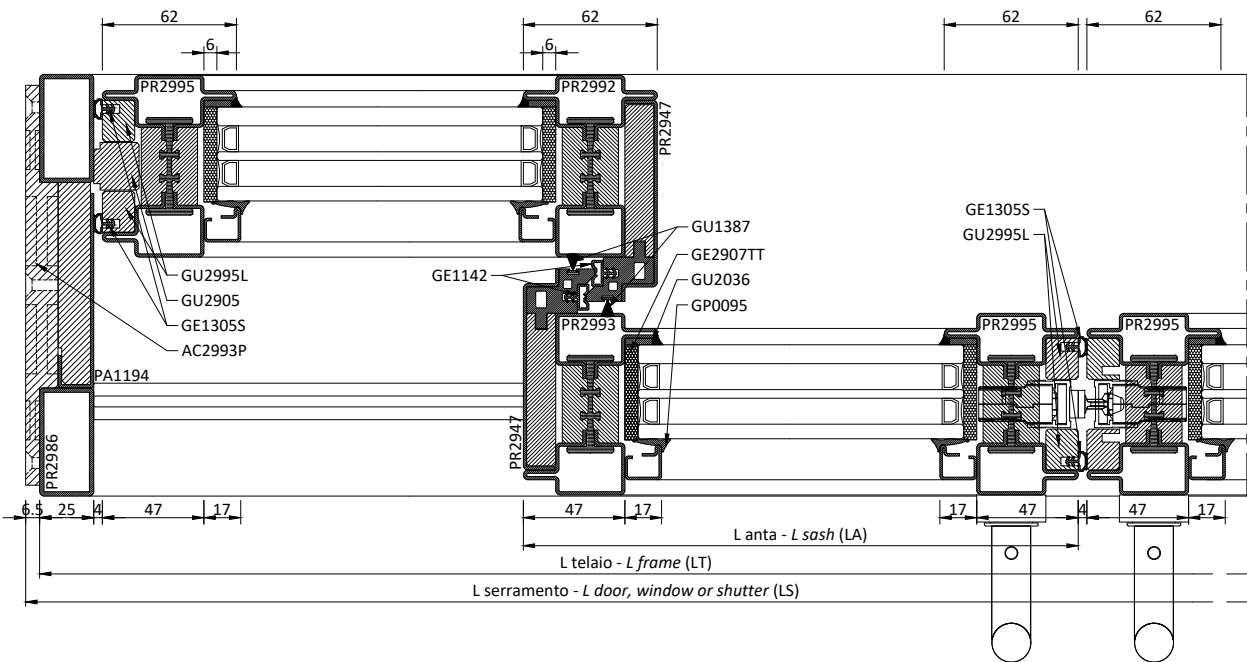
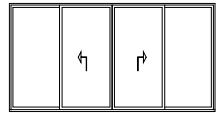
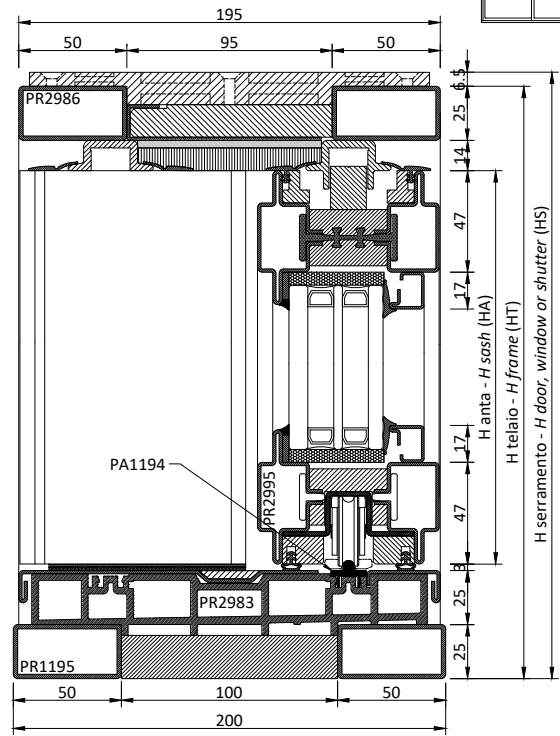
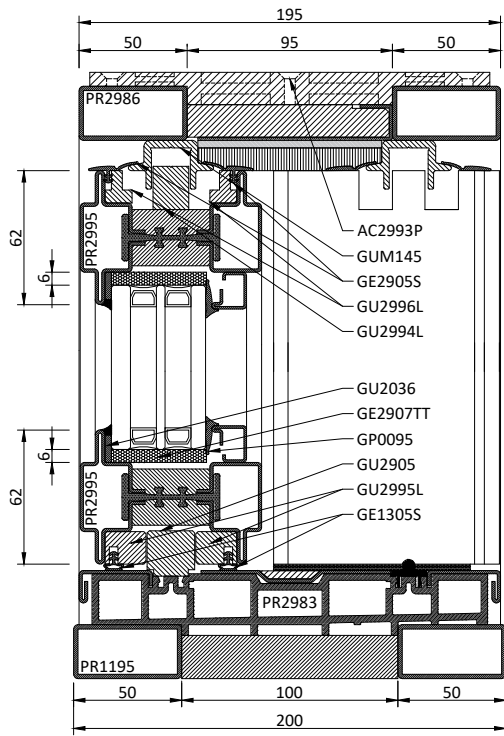

<b>PROFILI</b>		<b>PROFILES</b>			
Cod.	Descrizione	Description	n°	Dim.	Taglio/Cutting
<b>Telaio</b>		<b>Frame</b>			
PR2986	Profilo 50x25	Profile 50x25	2	LT	90 90
	Profilo 50x25	Profile 50x25	4	HT-25	90 90
	Profilo plastico	Plastic profile	2	LT/4+13	90 90
	Profilo plastico	Plastic profile	1	LT/2-26	90 90
	Profilo plastico	Plastic profile	2	HT-25	90 90
	Profilo centrale a "C"	"C" profile	2	LT/4+10	90 90
	Profilo centrale a "C"	"C" profile	1	LT/2-31	90 90
PR1195	Tubo in acciaio 50x25 mm	50x25 mm steel tube	2	LT-50	90 90
	Profilo plastico	Plastic profile	1	LT-50	90 90
PR2983	Telaio base - copertina esterna (Part. A)	Lower frame - external cover (Detail A)	2	LT/4-11,5	90 90
	Telaio base - copertina interna (Part. A)	Lower frame - internal cover (Detail A)	1	LT-50	90 90
	Telaio base - copertina centrale (Part. B)	Lower frame - central cover (Detail B)	2	LT/4-39	90 90
	Telaio base - copertina esterna (Part. C)	Lower frame - external cover (Detail C)	1	LT/2-27	90 90
	Telaio base - profilo poliammide di supporto guide	Lower frame - polyamide profile of rails	1	LT-50	90 90
<b>Guide</b>		<b>Rail</b>			
GUM145	Profilo guida superiore anta mobile	Upper rail of sliding sash	1	LT-50	90 90
	Profilo guida superiore anta fissa	Upper rail of fixed sash	2	LT/4+16	90 90
PA1194	Profilo guida inferiore	Lower profile	1	LT-50	90 90
<b>Anta</b>		<b>Sash</b>			
PR2995	Profilo zoccolo	Bottom rail profile	8	LT/4+15,5	45 45
	Profilo zoccolo	Bottom rail profile	4	HT-92	45 45
PR2992	Profilo a "T"	"T" profile	2	HT-92	45 45
PR2993	Profilo a "Z"	"Z" profile	2	HT-92	45 45
PR2947	Profilo labirinto centrale - anta mobile (Part. 1)	Central labyrinth profile - sliding sash (Detail 1)	2	HT-92	90 90
	Profilo labirinto centrale - anta mobile (Part. 2-3)	Central labyrinth profile - sliding sash (Detail 2)	2	HT-132	90 90
	Profilo labirinto centrale - anta fissa (Part. 1)	Central labyrinth profile - sliding sash (Detail 1)	2	HT-92	90 90
	Profilo labirinto centrale - anta fissa (Part. 2-3)	Central labyrinth profile - sliding sash (Detail 2)	2	HT-132	90 90
GU2995L	Profilo plastico porta guarnizione perimetrale	Plastic profile for rebate gasket support	8	HT-92	45 45
	Profilo plastico porta guarnizione perimetrale	Plastic profile for rebate gasket support	4	LT/4	45 90
	Profilo plastico porta guarnizione perimetrale	Plastic profile for rebate gasket support	4	LT/4	90 45
GU2996L	Profilo plastico porta guarnizione superiore	Plastic profile for rebate gasket support	4	LT/4	90 45
	Profilo plastico porta guarnizione superiore	Plastic profile for rebate gasket support	4	LT/4	45 90
GU2994L	Pattino di scorrimento anta mobile e fissa	Runner for sliding and fixed sash	4	LT/4+10	90 90
GU2905	Estruso di compensazione	Compensation extrusion	2	HT-107	90 90
	Estruso di compensazione	Compensation extrusion	2	LT/4-65	90 90
<b>Fermavetri</b>		<b>Glazing beads</b>			
PR2606	Profilo fermavetro	Glazing bead profile	4	LT/4-78,5	45 45
	Profilo fermavetro	Glazing bead profile	4	HT-186	45 45
<b>Vetri</b>		<b>Glass unit</b>			
	Vetrocamera	Double glazing	2	(LT/4-90,5)*(HT-198)	
<b>ACCESSORI</b>		<b>HARDWARE</b>			
Cod.	Descrizione	Description	n°	Note/Notes	
AC2995R.xx	Kit piastrelle di giunzione telaio esterno PR2986	Kit of external frame junction plates PR2986	4		
AC2993P	Accessorio assemblaggio telaio	Frame assemblage accessory	var.		
CV5403I	Rondella in acciaio inox/epdm	Stainless steel/vulcanised epdm washer	var.		
AG2992L.EF	Rostro aggiuntivo	Additional hook bolt	opz.		
AG2996E.xx	Kit alzanze scorrevole	Lift and slide kit	1		
ACV ____	Maniglione	Large handle	2		
AC2995.1	Kit squadrette di giunzione ante	Corner joint kit Sashes	4		
AG2989L.EF	Prolunga superiore cremonese	Upper cremonese extension	1	>2908	
AG2989C	Profilo di copertura aggiuntivo	Additional covering profile	1	>2908	
AC1305G	Angolo vulcanizzato per GE1305S	Vulcanised corner gasket for GE1305S	6		
AC2608AR	Clips fissaggio fermavetri	Clips for glazing bead	var.		
<b>GUARNIZIONI*</b>		<b>GASKETS*</b>			
Cod.	Descrizione	Description	n°	Dim.	
GU2036	Piattina adesiva morbida esterno vetro	Soft adhesive shim for external window	1	2xLT+8xHT	
GU2907TT	Guarnizione sotto vetro	Under glass gasket	1	2xLT+8xHT	
GP0095	Guarnizione interna vetro	Internal glass gasket	1	2xLT+8xHT	
GE2905S	Guarnizione superiore ante	Gasket for upper sash	1	2xLT	
GE1305S	Guarnizione perimetrale ante	Gasket for side sash	1	2xLT+6xHT	
GE1142	Guarnizione labirinto centrale	Gasket for central labyrinth	1	4xHT	
GU1387	Spazzolino verticale labirinto	Vertical labyrinth brush + adhesive	1	4xHT	
* le dimensioni delle guarnizioni sono indicative e devono essere aumentate del 10% per adattamenti e ritiri del materiale nel tempo					
* the gasket dimensions are indicative and have to be increased by 10% owing to adaptation and contractions of the material over time					

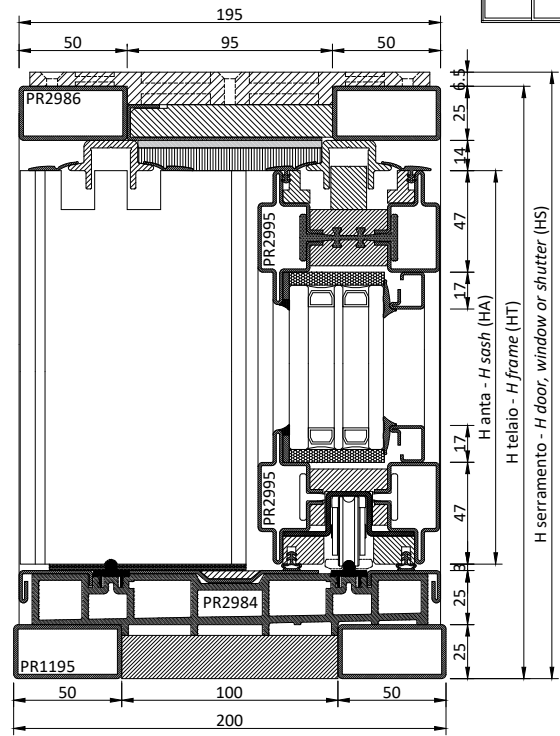
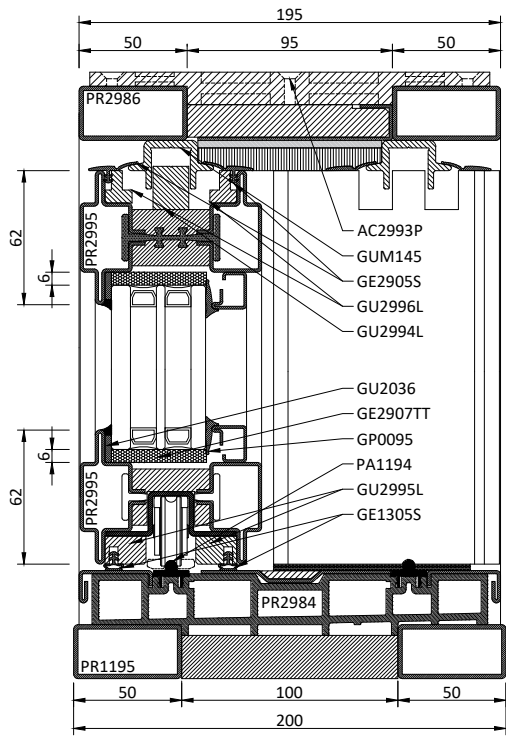

↗	↘	↗	↘
---	---	---	---

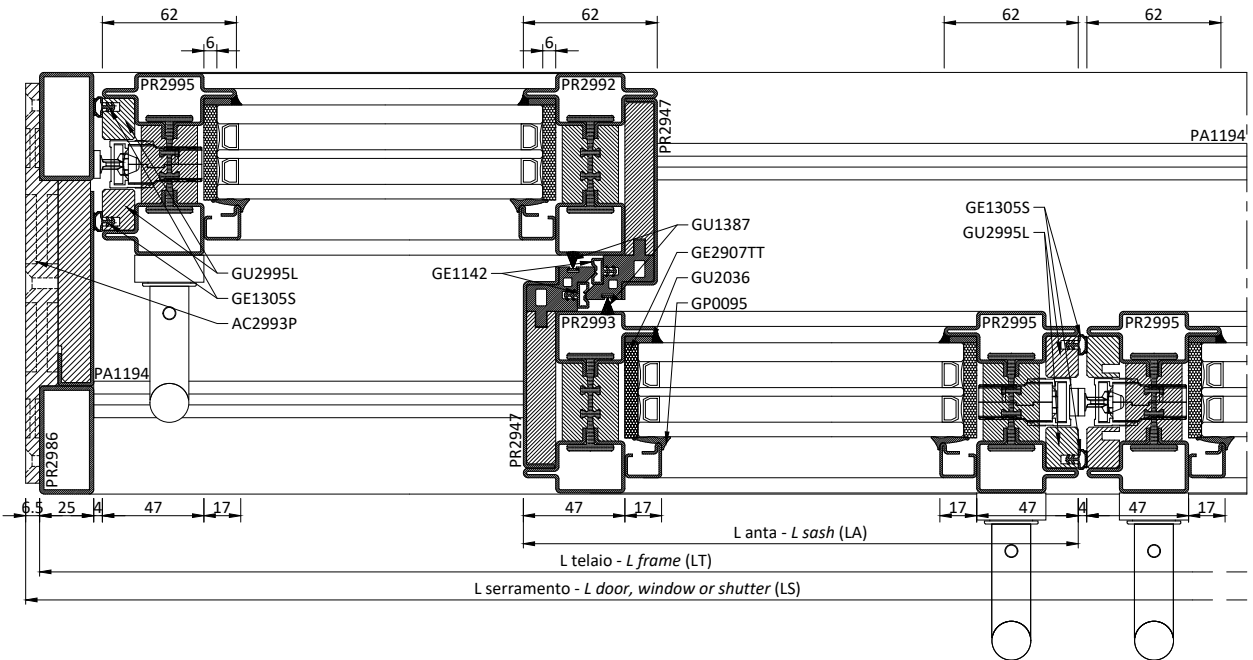

PROFILI		PROFILES			
Cod.	Descrizione	Description	n°	Dim.	Taglio/Cutting
<b>Telaio</b>					
<b>Frame</b>					
PR2986	Profilo 50x25	Profile 50x25	2	LT	90 90
	Profilo 50x25	Profile 50x25	4	HT-25	90 90
	Profilo plastico	Plastic profile	2	LT/4+13	90 90
	Profilo plastico	Plastic profile	1	LT/2-26	90 90
	Profilo plastico	Plastic profile	2	HT-25	90 90
	Profilo centrale a "C"	"C" profile	2	LT/4+10	90 90
	Profilo centrale a "C"	"C" profile	1	LT/2-31	90 90
PR1195	Tubo in acciaio 50x25 mm	50x25 mm steel tube	2	LT-50	90 90
	Profilo plastico	Plastic profile	1	LT-50	90 90
PR2984	Telaio base - copertina interna (Part. A)	Lower frame - internal cover (Detail A)	2	LT-50	90 90
	Telaio base - copertina centrale (Part. B)	Lower frame - central cover (Detail B)	2	LT/4-39	90 90
	Telaio base - copertina centrale (Part. B)	Lower frame - central cover (Detail B)	1	LT/2-83	90 90
	Telaio base - profilo poliammide di supporto guide	Lower frame - polyamide profile of rails	1	LT-50	90 90
<b>Guide</b>					
<b>Rail</b>					
GUM145	Profilo guida superiore anta mobile	Upper rail of sliding sash	2	LT-50	90 90
PA1194	Profilo guida inferiore	Lower profile	2	LT-50	90 90
<b>Anta</b>					
<b>Sash</b>					
PR2995	Profilo zoccolo	Bottom rail profile	8	LT/4+15,5	45 45
	Profilo zoccolo	Bottom rail profile	4	HT-92	45 45
PR2992	Profilo a "T"	"T" profile	2	HT-92	45 45
PR2993	Profilo a "Z"	"Z" profile	2	HT-92	45 45
PR2947	Profilo labirinto centrale - anta mobile (Part. 1)	Central labyrinth profile - sliding sash (Detail 1)	4	HT-92	90 90
	Profilo labirinto centrale - anta mobile (Part. 2-3)	Central labyrinth profile - sliding sash (Detail 2)	4	HT-132	90 90
GU2995L	Profilo plastico porta guarnizione perimetrale	Plastic profile for rebate gasket support	8	HT-92	45 45
	Profilo plastico porta guarnizione perimetrale	Plastic profile for rebate gasket support	4	LT/4	45 90
	Profilo plastico porta guarnizione perimetrale	Plastic profile for rebate gasket support	4	LT/4	90 45
GU2996L	Profilo plastico porta guarnizione superiore	Plastic profile for rebate gasket support	4	LT/4	90 45
	Profilo plastico porta guarnizione superiore	Plastic profile for rebate gasket support	4	LT/4	45 90
GU2994L	Pattino di scorrimento anta mobile e fissa	Runner for sliding and fixed sash	2	LT/4+10	90 90
<b>Fermavetri</b>					
<b>Glazing beads</b>					
PR2606	Profilo fermavetro	Glazing bead profile	4	LT/4-78,5	45 45
	Profilo fermavetro	Glazing bead profile	4	HT-186	45 45
<b>Vetri</b>					
<b>Glass unit</b>					
	Vetrocamera	Double glazing	2	(LT/2-90,5)×(HT-198)	
<b>ACCESSORI</b>					
<b>HARDWARE</b>					
Cod.	Descrizione	Description	n°	Note/Notes	
AC2995R.xx	Kit piastri di giunzione telaio esterno PR2986	Kit of external frame junction plates PR2986	4		
AC2993P	Accessorio assiemaggio telaio	Frame assemblage accessory	var.		
AG2992L.EF	Rostro aggiuntivo	Additional hook bolt	opz.		
AG2996F.xx	Kit alzante scorrevole	Lift and slide kit	1		
ACV___	Maniglione	Large handle	4		
AC2995.1	Kit squadrette di giunzione ante	Corner joint kit Sashes	4		
AG2989.EF	Prolunga superiore cremonese	Upper cremonese extension	opz.	> 2908	
AG2989C	Profilo di copertura aggiuntivo	Additional covering profile	opz.	> 2908	
AC1305G	Angolo vulcanizzato per GE1305S	Vulcanised corner gasket for GE1305S	6		
AC2608AR	Clips fissaggio fermavetri	Clips for glazing bead	var.		
<b>GUARNIZIONI*</b>					
<b>GASKETS*</b>					
Cod.	Descrizione	Description	n°	Dim.	
GU2036	Piattina adesiva morbida esterno vetro	Soft adhesive shim for external window	1	2xLT+8xHT	
GU2907TT	Guarnizione sotto vetro	Under glass gasket	1	2xLT+8xHT	
GP0095	Guarnizione interna vetro	Internal glass gasket	1	2xLT+8xHT	
GE2905S	Guarnizione superiore ante	Gasket for upper sash	1	2xLT	
GE1305S	Guarnizione perimetrale ante	Gasket for side sash	1	2xLT+6xHT	
GE1142	Guarnizione labirinto centrale	Gasket for central labyrinth	1	4xHT	
GU1387	Spazzolino verticale labirinto	Vertical labyrinth brush + adhesive	1	4xHT	
* le dimensioni delle guarnizioni sono indicative e devono essere aumentate del 10% per adattamenti e ritiri del materiale nel tempo					
* the gasket dimensions are indicative and have to be increased by 10% owing to adaptation and contractions of the material over time					

4	4
---	---

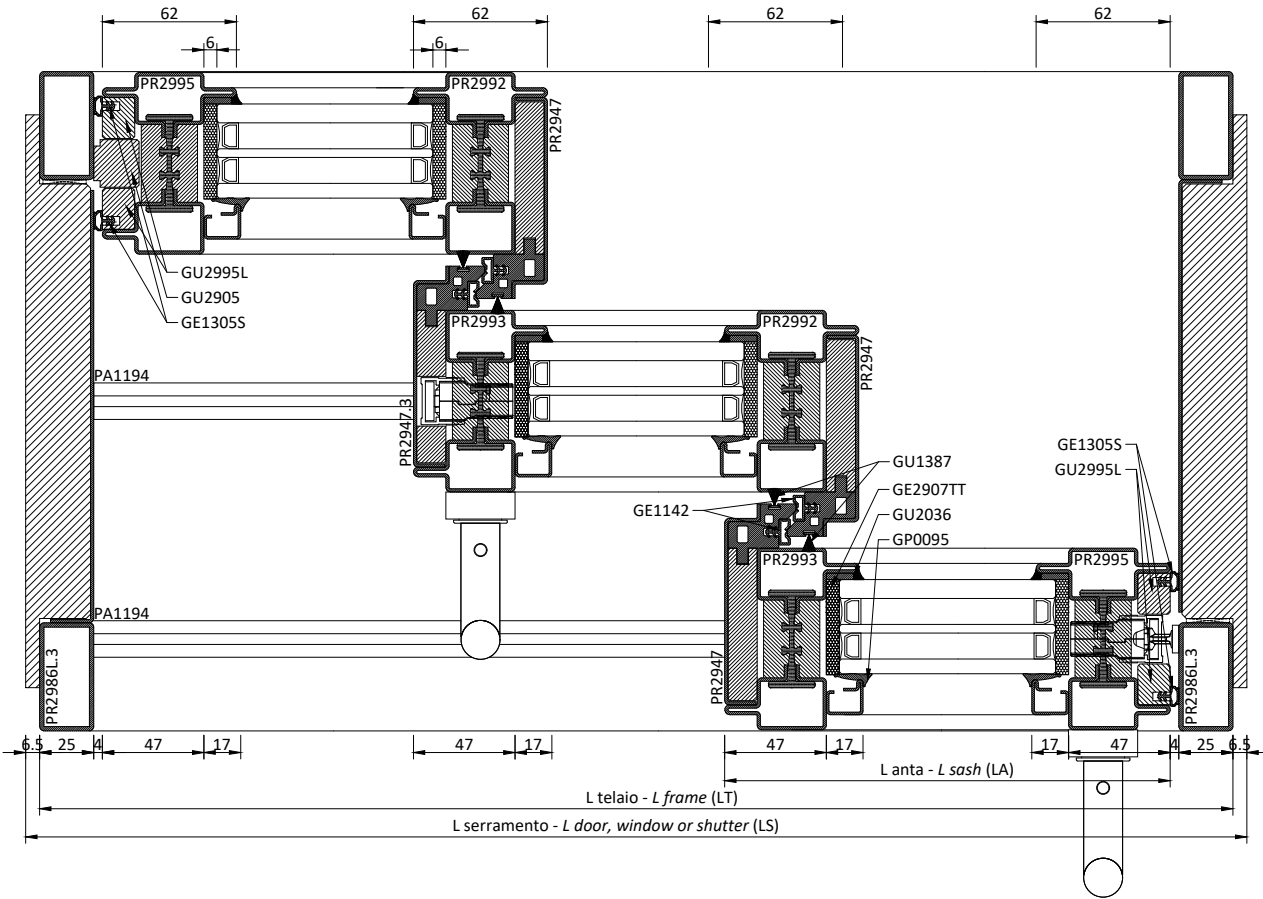
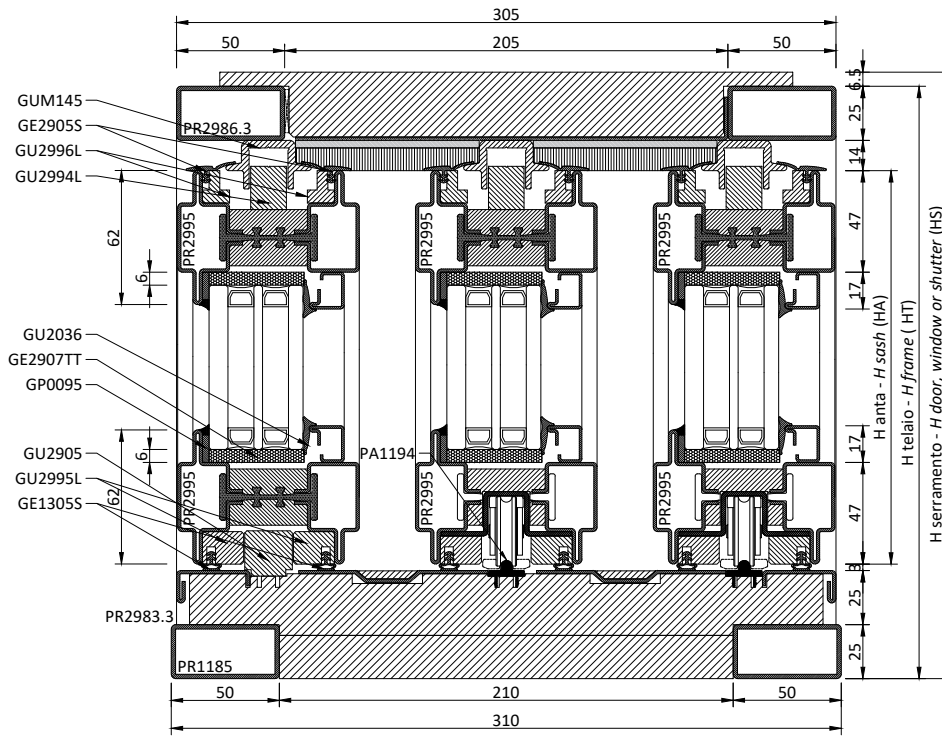

PROFILI		PROFILES			
Cod.	Descrizione	Description	n°	Dim.	Taglio/Cutting
<b>Telaio</b>		<b>Frame</b>			
PR2986.3	Profilo 50x25	Profile 50x25	2	LT	90 90
	Profilo plastico	Plastic profile	1	LT	90 90
	Profilo centrale a "L"	"L" profile	2	LT/3+17	90 90
	Profilo centrale a "C"	"C" profile	1	LT/3-40	90 90
PR2986L.3	Profilo 50x25	Profile 50x25	4	HT-25	90 90
	Profilo plastico	Plastic profile	2	HT-25	90 90
	Profilo centrale a "L"	"L" profile	2	HT-25	90 90
PR1185	Tubo in acciaio 50x25 mm	50x25 mm steel tube	2	LT-50	90 90
	Profilo plastico	Plastic profile	1	LT-50	90 90
PR2983.3	Telaio base - copertina esterna (Part. A)	Lower frame - external cover (Detail A)	1	LT/3-5	90 90
	Telaio base - copertina interna (Part. A)	Lower frame - internal cover (Detail A)	1	LT-50	90 90
	Telaio base - copertina centrale (Part. B)	Lower frame - central cover (Detail B)	1	LT/3-33	90 90
	Telaio base - copertina centrale (Part. B)	Lower frame - central cover (Detail B)	1	2LT/3-73	90 90
	Telaio base - copertina esterna (Part. C)	Lower frame - external cover (Detail C)	1	LT/3-40	90 90
	Telaio base - copertina esterna (Part. E)	Lower frame - external cover (Detail E)	1	LT/3-5	90 90
	Telaio base - profilo poliammide di supporto guide	Lower frame - polyamide profile of rails	1	LT-50	90 90
<b>Guide</b>		<b>Rail</b>			
GUM145	Profilo guida superiore anta mobile	Upper rail of sliding sash	1	LT-50	90 90
GUM145	Profilo guida superiore anta mobile	Upper rail of sliding sash	1	2LT/3-17	90 90
GUM145	Profilo guida superiore anta fissa	Upper rail of sliding sash	2	LT/3+23	90 90
PA1194	Profilo guida inferiore	Lower profile	1	LT-50	90 90
PA1194	Profilo guida inferiore	Lower profile	1	2LT/3-48	90 90
<b>Anta</b>		<b>Sash</b>			
PR2995	Profilo zoccolo	Bottom rail profile	6	LT/3+22	45 45
	Profilo zoccolo	Bottom rail profile	2	HT-92	45 45
PR2992	Profilo a "T"	"T" profile	2	HT-92	45 45
PR2993	Profilo a "Z"	"Z" profile	2	HT-92	45 45
PR2947	Profilo labirinto centrale - anta mobile (Part. 1)	Central labyrinth profile - sliding sash (Detail 1)	2	HT-92	90 90
	Profilo labirinto centrale - anta mobile (Part. 2-3)	Central labyrinth profile - sliding sash (Detail 2)	2	HT-132	90 90
	Profilo labirinto centrale - anta fissa (Part. 1)	Central labyrinth profile - sliding sash (Detail 1)	1	HT-92	90 90
	Profilo labirinto centrale - anta fissa (Part. 2-3)	Central labyrinth profile - sliding sash (Detail 2)	1	HT-132	90 90
PR2947.3	Profilo labirinto centrale - anta mobile (Part. 1)	Central labyrinth profile - sliding sash (Detail 1)	1	HT-92	90 90
	Profilo labirinto centrale - anta mobile (Part. 2-3-4)	Central labyrinth profile - sliding sash (Detail 2)	1	HT-132	90 90
GU2995L	Profilo plastico porta guarnizione perimetrale	Plastic door profile perimeter gasket	4	HT-92	45 45
	Profilo plastico porta guarnizione perimetrale	Plastic door profile perimeter gasket	2	LT/3+7	45 90
	Profilo plastico porta guarnizione perimetrale	Plastic door profile perimeter gasket	2	LT/3+7	90 45
	Profilo plastico porta guarnizione perimetrale	Plastic door profile perimeter gasket	2	LT/3-8	90 90
GU2996L	Profilo plastico porta guarnizione superiore	Plastic door profile upper gasket	2	LT/3+7	90 45
	Profilo plastico porta guarnizione superiore	Plastic door profile upper gasket	2	LT/3+7	45 90
GU2994L	Profilo plastico porta guarnizione superiore	Plastic door profile upper gasket	2	LT/3-8	90 90
	Pattino di scorrimento anta mobile e fissa	Runner for sliding and fixed sash	3	LT/3+17	90 90
GU2905	Estruso di compensazione	Compensation extrusion	1	LT/3-58	90 90
	Estruso di compensazione	Compensation extrusion	1	HT-107	90 90
<b>Fermavetri</b>		<b>Glazing beads</b>			
PR2606	Profilo fermavetro	Glazing bead profile	6	LT/3-72	45 45
	Profilo fermavetro	Glazing bead profile	6	HT-186	45 45
<b>Vetri</b>		<b>Glass unit</b>			
	Vetrocamera	Double glazing	2	(LT/3-84)×(HT-198)	
<b>ACCESSORI</b>		<b>HARDWARE</b>			
Cod.	Descrizione	Description	n°	Note/Notes	
AC2995R.xx	Kit piastine di giunzione telaio esterno PR2986	Kit of external frame junction plates PR2986	4		
AG2992L.AB	Rostro aggiuntivo	Additional hook bolt	opz.		
AG2996J7A3.xx	Kit alzante scorrevole	Lift and slide kit	1		
ACV___	Maniglione	Large handle	2		
AC2995.1	Kit squadrette di giunzione ante	Corner joint kit Sashes	2		
AC2995.2	Kit squadrette di giunzione ante	Corner joint kit Sashes	1		
AG2989L.AB	Prolunga superiore cremonese	Upper cremonese extension	opz.	> 2908	
AG2989C	Profilo di copertura aggiuntivo	Additional covering profile	opz.	> 2908	
AC1305G	Angolo vulcanizzato per GE1305S	Vulcanised corner gasket for GE1305S	4		
AC2608AR	Clips fissaggio fermavetri	Clips for glazing bead	var.		
<b>GUARNIZIONI*</b>		<b>GASKETS*</b>			
Cod.	Descrizione	Description	n°	Dim.	
GU2036	Piattina adesiva morbida esterno vetro	Soft adhesive shim for external window	1	2xLT+6xHT	
GU2907TT	Guarnizione sotto vetro	Under glass gasket	1	2xLT+6xHT	
GP0095	Guarnizione interna vetro	Internal glass gasket	1	2xLT+6xHT	
GE2905S	Guarnizione superiore ante	Gasket for upper sash	1	2xLT	
GE1305S	Guarnizione perimetrale ante	Gasket for side sash	1	2xLT+4xHT	
GE1142	Guarnizione labirinto centrale	Gasket for central labyrinth	1	4xHT	
GU1387	Spazzolino verticale labirinto	Vertical labyrinth brush + adhesive	1	4xHT	
* Le dimensioni delle guarnizioni sono indicative e devono essere aumentate del 10% per adattamenti e ritiri del materiale nel tempo					
* the gasket dimensions are indicative and have to be increased by 10% owing to adaptation and contractions of the material over time					



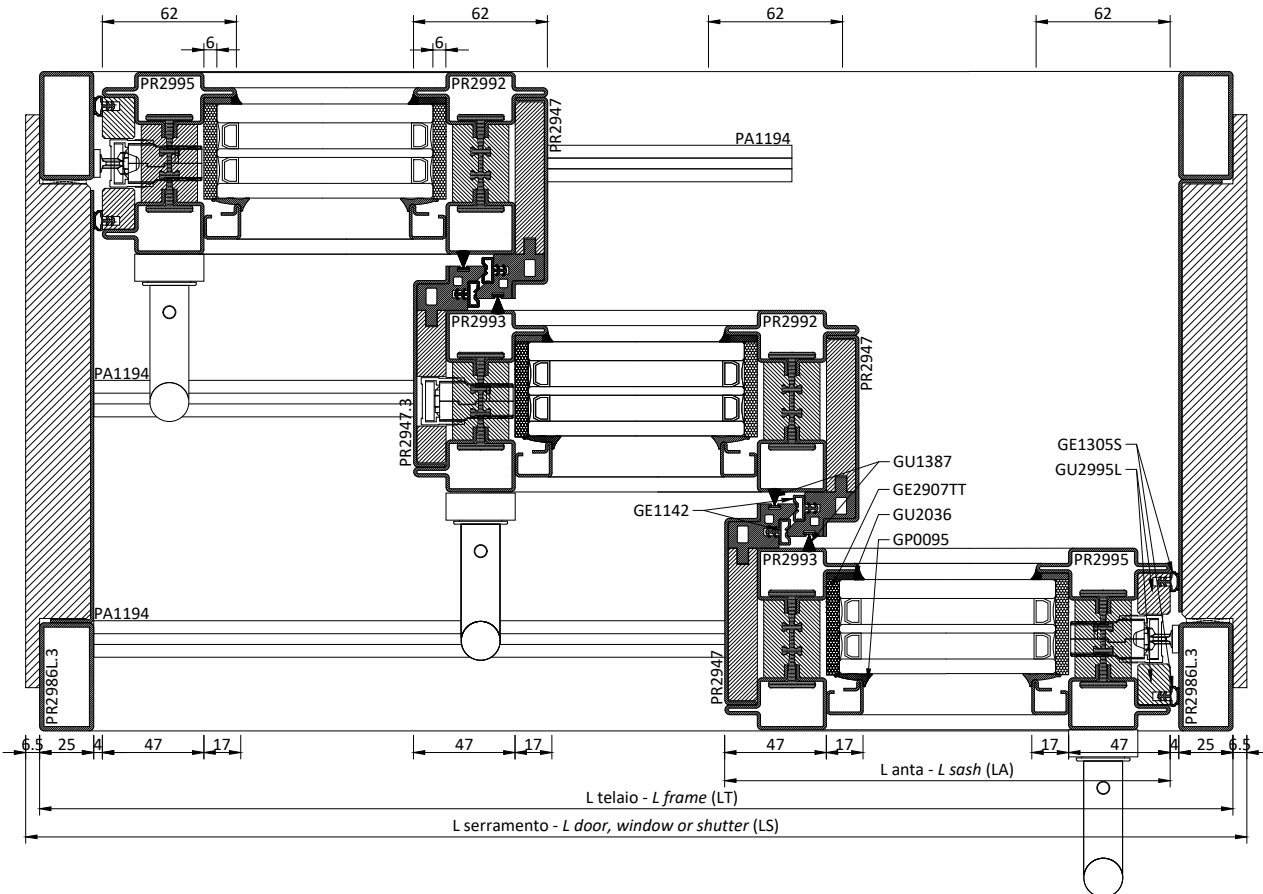
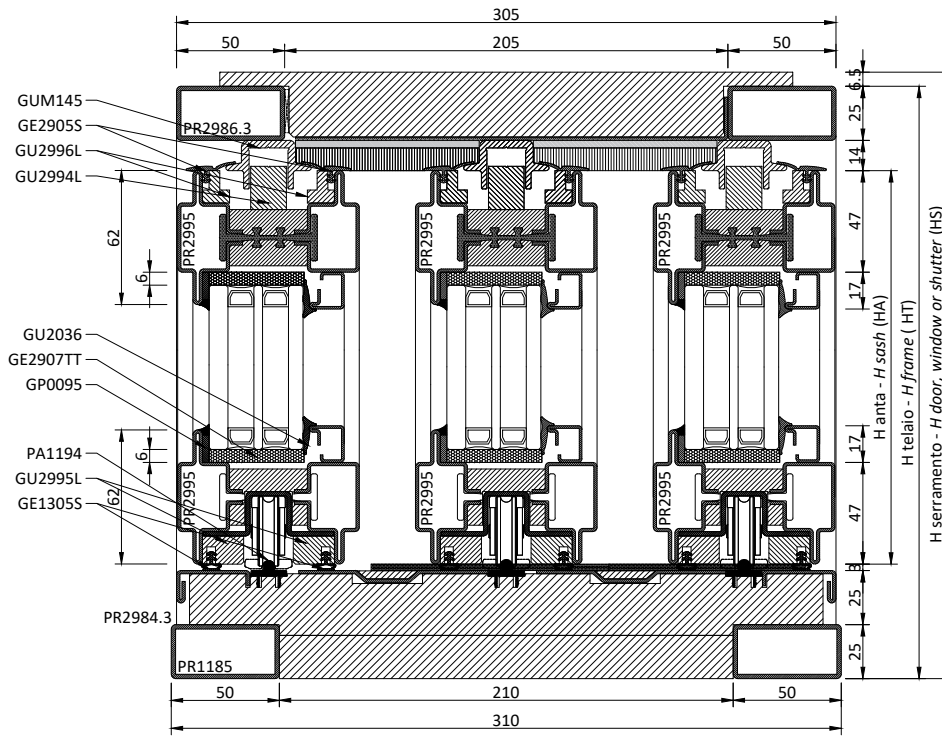
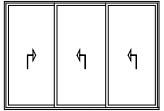



PROFILI		PROFILES				
Cod.	Descrizione	Description	n°	Dim.	Taglio/ Cutting	
<b>Telaio</b>		<b>Frame</b>				
PR2986.3	Profilo 50x25	Profile 50x25	2	LT	90	90
	Profilo plastico	Plastic profile	1	LT	90	90
	Profilo centrale a "L"	"L" profile	2	LT/3+17	90	90
	Profilo centrale a "C"	"C" profile	2	LT/3-40	90	90
PR2986L.3	Profilo 50x25	Profile 50x25	4	HT-25	90	90
	Profilo plastico	Plastic profile	2	HT-25	90	90
	Profilo centrale a "L"	"L" profile	2	HT-25	90	90
PR1185	Tubo in acciaio 50x25 mm	50x25 mm steel tube	2	LT-50	90	90
	Profilo plastico	Plastic profile	1	LT-50	90	90
PR2984.3	Telaio base - copertina esterna (Part. A)	Lower frame - external cover (Detail A)	1	2LT/3-45	90	90
	Telaio base - copertina interna (Part. A)	Lower frame - internal cover (Detail A)	1	LT-50	90	90
	Telaio base - copertina centrale (Part. B)	Lower frame - central cover (Detail B)	1	LT/3-33	90	90
	Telaio base - copertina centrale (Part. B)	Lower frame - central cover (Detail B)	1	LT/3-68	90	90
	Telaio base - copertina centrale (Part. B)	Lower frame - central cover (Detail B)	1	2LT/3-73	90	90
	Telaio base - copertina esterna (Part. E)	Lower frame - external cover (Detail E)	1	LT/3-5	90	90
	Telaio base - profilo poliammide di supporto guide	Lower frame - polyamide profile of rails	1	LT-50	90	90
<b>Guide</b>		<b>Rail</b>				
GUM145	Profilo guida superiore anta mobile	Upper rail of sliding sash	1	LT-50	90	90
GUM145	Profilo guida superiore anta mobile	Upper rail of sliding sash	2	2LT/3-17	90	90
PA1194	Profilo guida inferiore	Lower profile	1	LT-50	90	90
PA1194	Profilo guida inferiore	Lower profile	2	2LT/3-48	90	90
<b>Anta</b>		<b>Sash</b>				
PR2995	Profilo zoccolo	Bottom rail profile	6	LT/3+22	45	45
	Profilo zoccolo	Bottom rail profile	2	HT-92	45	45
PR2992	Profilo a "T"	"T" profile	2	HT-92	45	45
PR2993	Profilo a "Z"	"Z" profile	2	HT-92	45	45
PR2947	Profilo labirinto centrale - anta mobile (Part. 1)	Central labyrinth profile - sliding sash (Detail 1)	3	HT-92	90	90
	Profilo labirinto centrale - anta mobile (Part. 2-3)	Central labyrinth profile - sliding sash (Detail 2)	3	HT-132	90	90
PR2947.3	Profilo labirinto centrale - anta mobile (Part. 1)	Central labyrinth profile - sliding sash (Detail 1)	1	HT-92	90	90
	Profilo labirinto centrale - anta mobile (Part. 2-3-4)	Central labyrinth profile - sliding sash (Detail 2)	1	HT-132	90	90
GU2995L	Profilo plastico porta guarnizione perimetrale	Plastic profile for rebate gasket support	4	HT-92	45	45
	Profilo plastico porta guarnizione perimetrale	Plastic profile for rebate gasket support	2	LT/3+7	45	90
	Profilo plastico porta guarnizione perimetrale	Plastic profile for rebate gasket support	2	LT/3+7	90	45
	Profilo plastico porta guarnizione perimetrale	Plastic profile for rebate gasket support	2	LT/3-8	90	90
GU2996L	Profilo plastico porta guarnizione perimetrale	Plastic profile for rebate gasket support	2	LT/3+7	90	45
	Profilo plastico porta guarnizione perimetrale	Plastic profile for rebate gasket support	2	LT/3+7	45	90
GU2994L	Profilo plastico porta guarnizione perimetrale	Plastic profile for rebate gasket support	2	LT/3-8	90	90
	Pattino di scorrimento anta mobile e fissa	Runner for sliding and fixed sash	3	LT/3+17	90	90
<b>Fermavetri</b>		<b>Glazing beads</b>				
PR2606	Profilo fermavetro	Glazing bead profile	6	LT/3-72	45	45
	Profilo fermavetro	Glazing bead profile	6	HT-186	45	45
<b>Vetri</b>		<b>Glass unit</b>				
	Vetrocamera	Double glazing	2	(LT/3-84)×(HT-198)		
<b>ACCESSORI</b>		<b>HARDWARE</b>				
Cod.	Descrizione	Description	n°	Note/Notes		
AC2995R.xx	Kit piastrelle di giunzione telaio esterno PR2986	Kit of external frame junction plates PR2986	4			
AG2992L.AB	Rostro aggiuntivo	Additional hook bolt	opz.			
AG2996J7B3.xx	Kit alzante scorrevole	Lift and slide kit	1			
ACV ___	Maniglione	Large handle	3			
AC2995.1	Kit squadrette di giunzione ante	Corner joint kit Sashes	2			
AC2995.2	Kit squadrette di giunzione ante	Corner joint kit Sashes	1			
AG2989L.AB	Prolunga superiore cremonese	Upper cremonese extension	opz.	> 2908		
AG2989C	Profilo di copertura aggiuntivo	Additional covering profile	opz.	> 2908		
AC1305G	Angolo vulcanizzato per GE1305S	Vulcanised corner gasket for GE1305S	4			
AC2608AR	Clips fissaggio fermavetri	Clips for glazing bead	var.			
<b>GUARNIZIONI*</b>		<b>GASKETS*</b>				
Cod.	Descrizione	Description	n°	Dim.		
GU2036	Piattina adesiva morbida esterno vetro	Soft adhesive shim for external window	1	2xLT+6xHT		
GU2907TT	Guarnizione sotto vetro	Under glass gasket	1	2xLT+6xHT		
GP0095	Guarnizione interna vetro	Internal glass gasket	1	2xLT+6xHT		
GE2905S	Guarnizione superiore ante	Gasket for upper sash	1	2xLT		
GE1305S	Guarnizione perimetrale ante	Gasket for side sash	1	2xLT+4xHT		
GE1142	Guarnizione labirinto centrale	Gasket for central labyrinth	1	4xHT		
GU1387	Spazzolino verticale labirinto	Vertical labyrinth brush + adhesive	1	4xHT		

\* Le dimensioni delle guarnizioni sono indicative e devono essere aumentate del 10% per adattamenti e ritiri del materiale nel tempo

\* the gasket dimensions are indicative and have to be increased by 10% owing to adaptation and contraction of the material over time

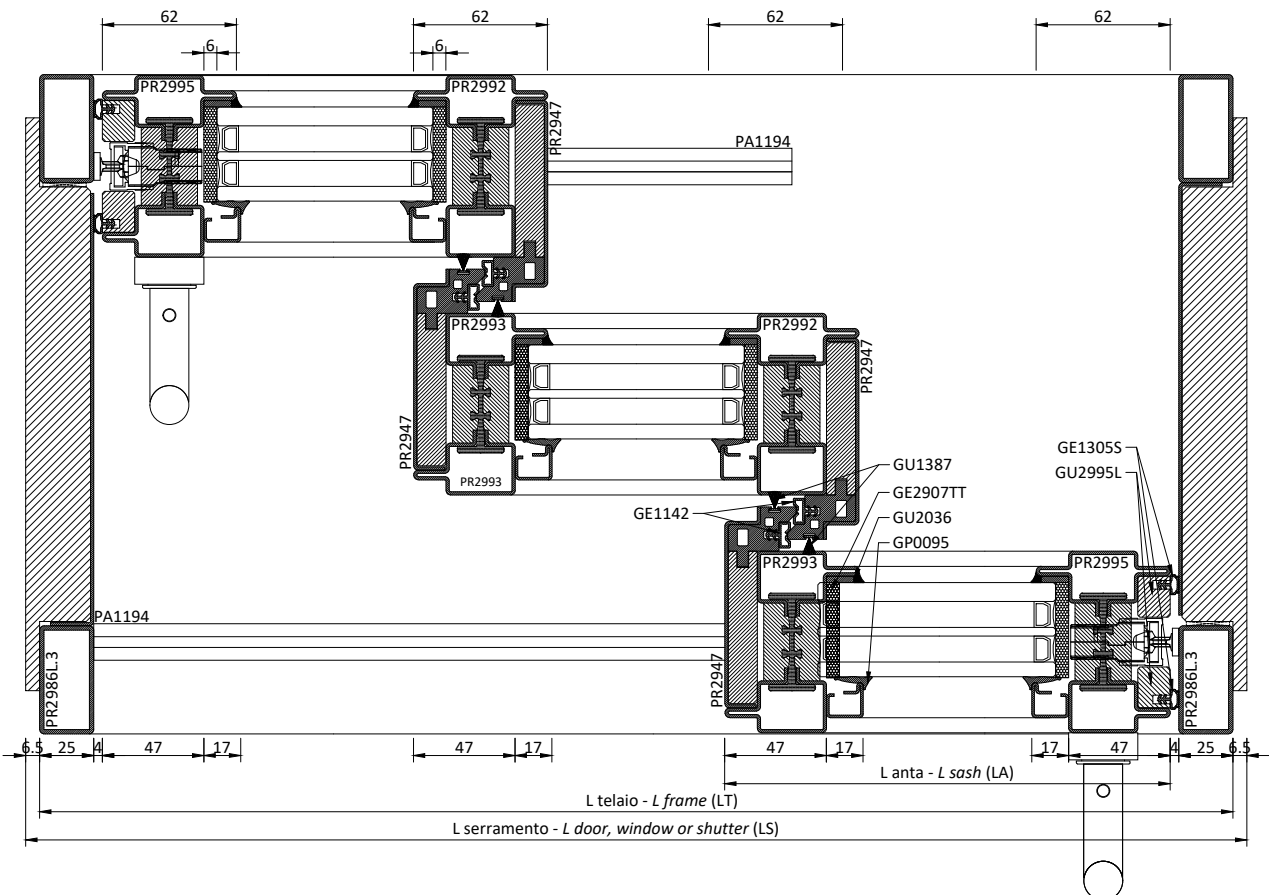
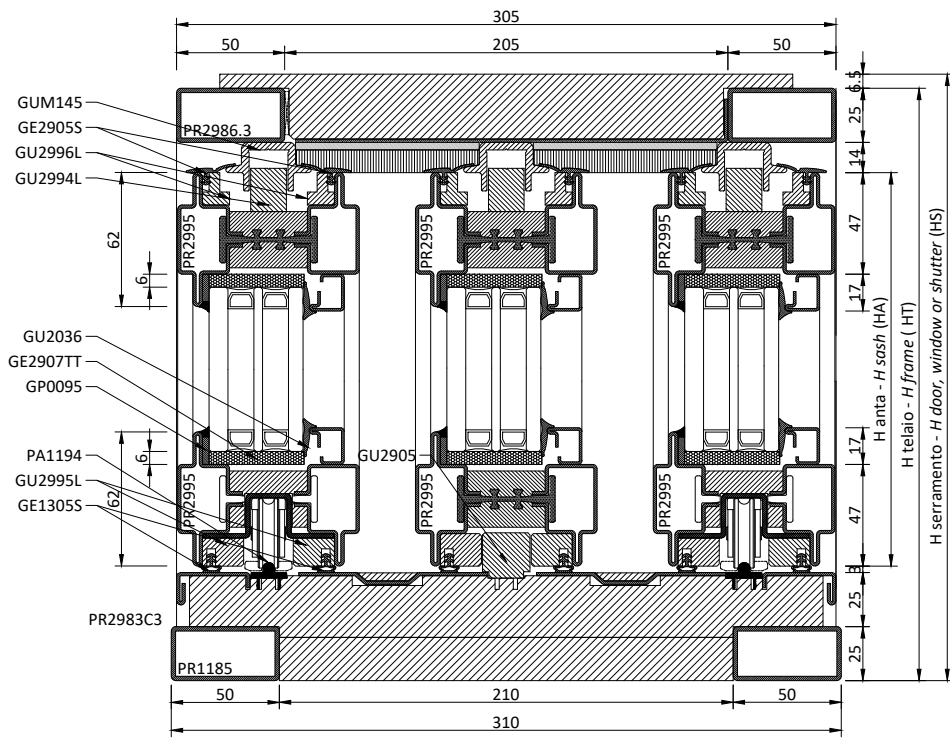
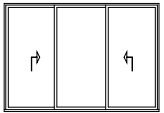

PROFILI		PROFILES			
Cod.	Descrizione	Description	n°	Dim.	Taglio/Cutting
<b>Telaio</b> <b>Frame</b>					
PR2986.3	Profilo 50x25	Profile 50x25	2	LT	90 90
	Profilo palastico	Plastic profile	1	LT	90 90
	Profilo centrale a "L"	"L" profile	2	LT/3+17	90 90
	Profilo centrale a "C"	"C" profile	2	LT/3-40	90 90
PR2986L.3	Profilo 50x25	Profile 50x25	4	HT-25	90 90
	Profilo palastico	Plastic profile	2	HT-25	90 90
	Profilo centrale a "L"	"L" profile	2	HT-25	90 90
PR1185	Tubo in acciaio 50x25 mm	50x25 mm steel tube	2	LT-50	90 90
	Estruso centrale di unione	Central extrusion junction	1	LT-50	90 90
PR2983C3	Telaio base - copertina esterna (Part. A)	Lower frame - external cover (Detail A)	1	2LT/3-45	90 90
	Telaio base - copertina interna (Part. A)	Lower frame - internal cover (Detail A)	1	LT-50	90 90
	Telaio base - copertina centrale (Part. B)	Lower frame - central cover (Detail B)	2	LT/3-68	90 90
	Telaio base - copertina centrale (Part. D)	Lower frame - central cover (Detail D)	1	LT/3-5	90 90
	Telaio base - copertina esterna (Part. E)	Lower frame - external cover (Detail E)	1	LT/3-5	90 90
	Telaio base - profilo poliammide di supporto guide	Lower frame - polyamide profile of rails	1	LT-50	90 90
<b>Guide</b> <b>Rail</b>					
GUM145	Profilo guida superiore anta mobile	Upper rail of sliding sash	1	LT/3+17	90 90
GUM145	Profilo guida superiore anta mobile	Upper rail of sliding sash	2	2LT/3-17	90 90
PA1194	Profilo guida inferiore	Lower profile	1	LT-50	90 90
PA1194	Profilo guida inferiore	Lower profile	1	2LT/3-45	90 90
<b>Anta</b> <b>Sash</b>					
PR2995	Profilo zoccolo	Bottom rail profile	6	LT/3+22	45 45
	Profilo zoccolo	Bottom rail profile	2	HT-92	45 45
PR2992	Profilo a "T"	"T" profile	2	HT-92	45 45
PR2993	Profilo a "Z"	"Z" profile	2	HT-92	45 45
PR2947	Profilo labirinto centrale - anta mobile (Part. 1)	Central labyrinth profile - sliding sash (Detail 1)	2	HT-92	90 90
	Profilo labirinto centrale - anta mobile (Part. 2-3)	Central labyrinth profile - sliding sash (Detail 2)	2	HT-132	90 90
	Profilo labirinto centrale - anta fissa (Part. 1)	Central labyrinth profile - sliding sash (Detail 1)	2	HT-92	90 90
	Profilo labirinto centrale - anta fissa (Part. 2-3)	Central labyrinth profile - sliding sash (Detail 2)	2	HT-132	90 90
GU2995L	Profilo plastico porta guarnizione perimetrale	Plastic profile for rebate gasket support	4	HT-92	45 45
	Profilo plastico porta guarnizione perimetrale	Plastic profile for rebate gasket support	2	LT/3+7	45 90
	Profilo plastico porta guarnizione perimetrale	Plastic profile for rebate gasket support	2	LT/3+7	90 45
	Profilo plastico porta guarnizione perimetrale	Plastic profile for rebate gasket support	2	LT/3-8	90 90
GU2996L	Profilo plastico porta guarnizione superiore	Plastic profile for rebate gasket support	2	LT/3+7	90 45
	Profilo plastico porta guarnizione superiore	Plastic profile for rebate gasket support	2	LT/3+7	45 90
GU2994L	Profilo plastico porta guarnizione superiore	Plastic profile for rebate gasket support	2	LT/3-8	90 90
	Pattino di scorrimento anta mobile e fissa	Runner for sliding and fixed sash	3	LT/3+17	90 90
<b>Fermavetri</b> <b>Glazing beads</b>					
PR2606	Profilo fermavetro	Glazing bead profile	6	LT/3-72	45 45
	Profilo fermavetro	Glazing bead profile	6	HT-186	45 45
<b>Vetri</b> <b>Glass unit</b>					
	Vetrocamera	Double glazing	2	(LT/3-84)×(HT-198)	
<b>ACCESSORI</b> <b>HARDWARE</b>					
Cod.	Descrizione	Description	n°	Note/Notes	
AC2995R.xx	Kit piastrelle di giunzione telaio esterno PR2986	Kit of external frame junction plates PR2986	4		
AG2992L.AB	Rostro aggiuntivo	Additional hook bolt	opz.		
AG2996J7C3.xx	Kit alzante scorrevole	Lift and slide kit	1		
ACV___	Maniglione	Large handle	2		
AC2995.1	Kit squadrette di giunzione ante	Corner joint kit Sashes	2		
AC2995.2	Kit squadrette di giunzione ante	Corner joint kit Sashes	1		
AG2989L.AB	Prolunga superiore cremonese	Upper cremonese extension	2	> 2908	
AG2989C	Profilo di copertura aggiuntivo	Additional covering profile	2	> 2908	
AC1305G	Angolo vulcanizzato per GE1305S	Vulcanised corner gasket for GE1305S	4		
AC2608AR	Clips fissaggio fermavetri	Clips for glazing bead	var.		
<b>GUARNIZIONI*</b> <b>GASKETS*</b>					
Cod.	Descrizione	Description	n°	Dim.	
GU2036	Piattina adesiva morbida esterno vetro	Soft adhesive shim for external window	1	2xLT+6xHT	
GU2907TT	Guarnizione sotto vetro	Under glass gasket	1	2xLT+6xHT	
GP0095	Guarnizione interna vetro	Internal glass gasket	1	2xLT+6xHT	
GE2905S	Guarnizione superiore ante	Gasket for upper sash	1	2xLT	
GE1305S	Guarnizione perimetrale ante	Gasket for side sash	1	2xLT+4xHT	
GE1142	Guarnizione labirinto centrale	Gasket for central labyrinth	1	4xHT	
GU1387	Spazzolino verticale labirinto	Vertical labyrinth brush + adhesive	1	4xHT	
* Le dimensioni delle guarnizioni sono indicative e devono essere aumentate del 10% per adattamenti e ritiri del materiale nel tempo					
* the gasket dimensions are indicative and have to be increased by 10% owing to adaptation and contraction of the material over time					

↵	↵	↵	↵
---	---	---	---

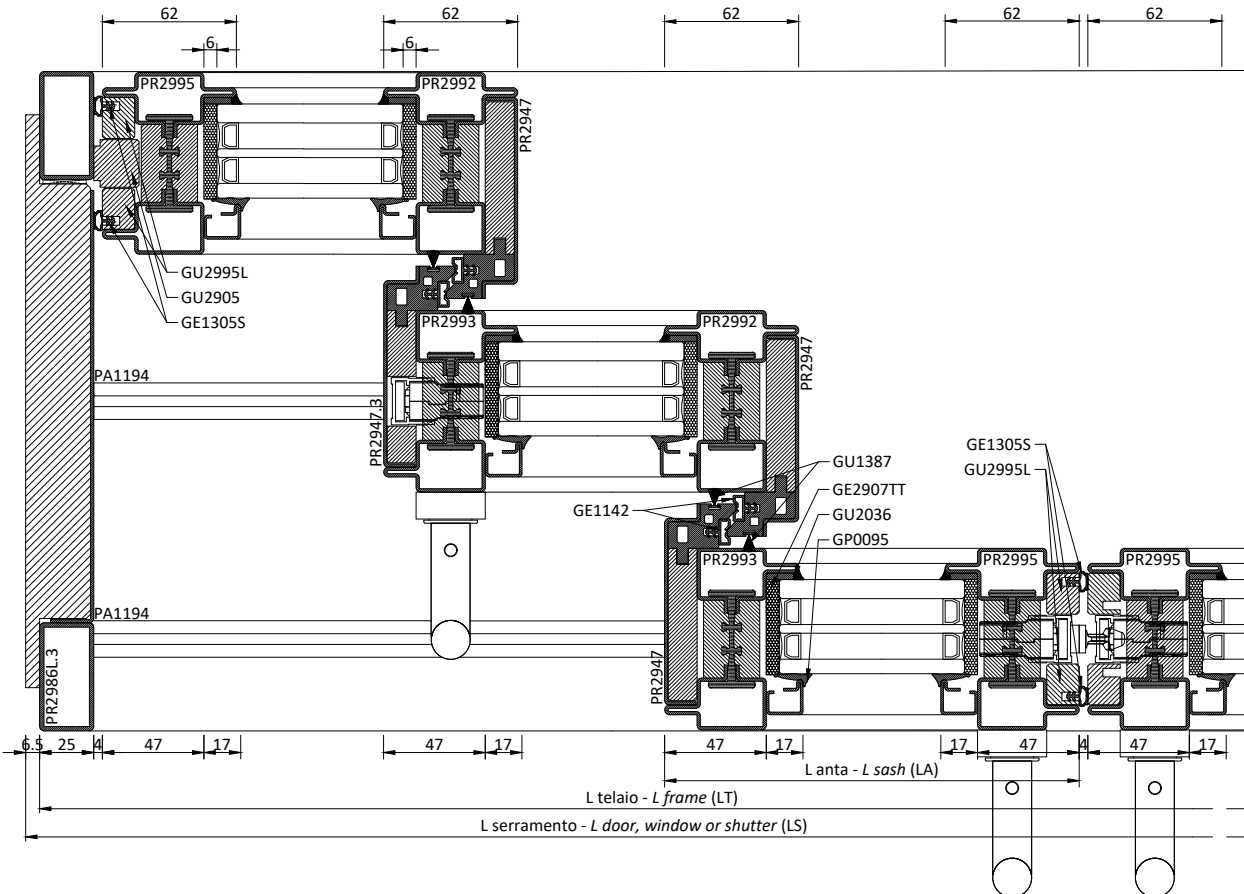
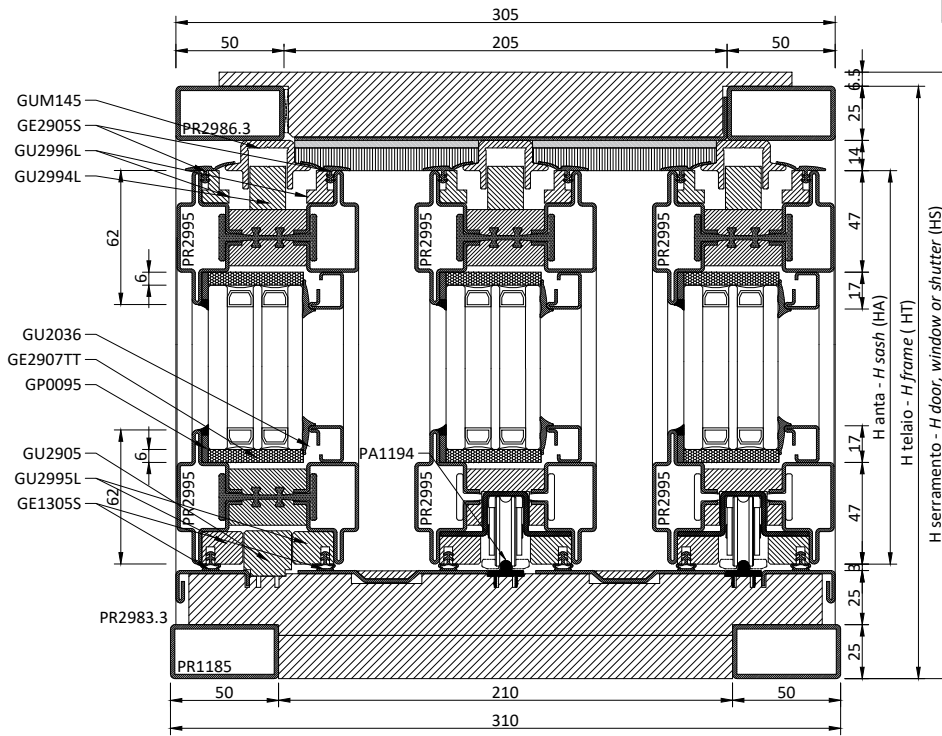

PROFILI		PROFILES				
Cod.	Descrizione	Description	n°	Dim.	Taglio/Cutting	
<b>Telaio</b>		<b>Frame</b>				
PR2986.3	Profilo 50x25	Profile 50x25	2	LT	90	90
	Profilo plastico	Plastic profile	1	LT	90	90
	Profilo centrale a "L"	"L" profile	2	LT/6+26	90	90
	Profilo centrale a "C"	"C" profile	2	LT/6-31	90	90
	Profilo centrale a "L"	"L" profile	1	LT/3-1	90	90
PR2986L.3	Profilo 50x25	Profile 50x25	4	HT - 25	90	90
	Profilo plastico	Plastic profile	2	HT-25	90	90
	Profilo centrale a "L"	"L" profile	2	HT-25	90	90
PR1185	Tubo in acciaio 50x25 mm	50x25 mm steel tube	2	LT-50	90	90
	Estruso centrale di unione	Central extrusion junction	1	LT-50	90	90
PR2983.3	Telaio base - copertina esterna (Part. A)	Lower frame - external cover (Detail A)	2	LT/6+4	90	90
	Telaio base - copertina interna (Part. A)	Lower frame - internal cover (Detail A)	1	LT-50	90	90
	Telaio base - copertina centrale (Part. B)	Lower frame - central cover (Detail B)	2	LT/6-24	90	90
	Telaio base - copertina centrale (Part. B)	Lower frame - central cover (Detail B)	2	LT/3-55	90	90
	Telaio base - copertina esterna (Part. C)	Lower frame - external cover (Detail C)	2	LT/6-31	90	90
	Telaio base - copertina esterna (Part. E)	Lower frame - external cover (Detail E)	1	LT/3+4	90	90
	Telaio base - profilo poliammide di supporto guide	Lower frame - polyamide profile of rails	1	LT-50	90	90
<b>Guide</b>		<b>Rail</b>				
GUM145	Profilo guida superiore anta mobile	Upper rail of sliding sash	1	LT-50	90	90
GUM145	Profilo guida superiore anta mobile	Upper rail of sliding sash	2	LT/3+1,5	90	90
GUM145	Profilo guida superiore anta fissa	Upper rail of sliding sash	2	LT/6+32,5	90	90
PA1194	Profilo guida inferiore	Lower profile	1	LT-50	90	90
PA1194	Profilo guida inferiore	Lower profile	2	LT/3-30	90	90
<b>Anta</b>		<b>Sash</b>				
PR2995	Profilo zoccolo	Bottom rail profile	12	LT/6+31	45	45
	Profilo zoccolo	Bottom rail profile	4	HT-92	45	45
PR2992	Profilo a "T"	"T" profile	4	HT-92	45	45
PR2993	Profilo a "Z"	"Z" profile	4	HT-92	45	45
PR2947	Profilo labirinto centrale - anta mobile (Part. 1)	Central labyrinth profile - sliding sash (Detail 1)	4	HT-92	90	90
	Profilo labirinto centrale - anta mobile (Part. 2-3)	Central labyrinth profile - sliding sash (Detail 2)	4	HT-132	90	90
	Profilo labirinto centrale - anta fissa (Part. 1)	Central labyrinth profile - sliding sash (Detail 1)	2	HT-92	90	90
	Profilo labirinto centrale - anta fissa (Part. 2-3)	Central labyrinth profile - sliding sash (Detail 2)	2	HT-132	90	90
PR2947.3	Profilo labirinto centrale - anta mobile (Part. 1)	Central labyrinth profile - sliding sash (Detail 1)	2	HT-92	90	90
	Profilo labirinto centrale - anta mobile (Part. 2-3-4)	Central labyrinth profile - sliding sash (Detail 2)	2	HT-132	90	90
GU2995L	Profilo plastico porta guarnizione perimetrale	Plastic profile for rebate gasket support	8	HT-92	45	45
	Profilo plastico porta guarnizione perimetrale	Plastic profile for rebate gasket support	4	LT/6+16	45	90
	Profilo plastico porta guarnizione perimetrale	Plastic profile for rebate gasket support	4	LT/6+16	90	45
	Profilo plastico porta guarnizione perimetrale	Plastic profile for rebate gasket support	4	LT/6+1	90	90
GU2996L	Profilo plastico porta guarnizione superiore	Plastic profile for rebate gasket support	4	LT/6+16	90	45
	Profilo plastico porta guarnizione superiore	Plastic profile for rebate gasket support	4	LT/6+16	45	90
	Profilo plastico porta guarnizione superiore	Plastic profile for rebate gasket support	4	LT/6+1	90	90
GU2994L	Pattino di scorrimento anta mobile e fissa	Plastic profile for rebate gasket support	6	LT/6+26	90	90
GU2905	Estruso di compensazione	Compensation extrusion	2	LT/6-49	90	90
	Estruso di compensazione	Compensation extrusion	2	HT-107	90	90
<b>Fermavetri</b>		<b>Glazing beads</b>				
PR2606	Profilo fermavetro	Glazing bead profile	6	LT/6-63	45	45
	Profilo fermavetro	Glazing bead profile	6	HT-186	45	45
<b>Vetri</b>		<b>Glass unit</b>				
	Vetrocamera	Double glazing	2	(LT/6-75) × (HT-198)		
<b>ACCESSORI</b>		<b>HARDWARE</b>				
Cod.	Descrizione	Description	n°	Note/Notes		
AC2995R.xx	Kit piastrine di giunzione telaio esterno PR2986	Kit of external frame junction plates PR2986	4			
AG2992L.EF	Rostro aggiuntivo	Additional hook bolt	opz.			
AG2996E3.xx	Kit alzanze scorrevole	Lift and slide kit	1			
ACV__	Maniglione	Large handle	4			
AC2995.1	Kit squadrette di giunzione ante	Corner joint kit Sashes	4			
AC2995.2	Kit squadrette di giunzione ante	Corner joint kit Sashes	2			
AG2989L.EF	Prolunga superiore cremonese	Upper cremonese extention	4	> 2908		
AG2989C	Profilo di copertura aggiuntivo	Additional covering profile	4	> 2908		
AC1305G	Angolo vulcanizzato per GE1305S	Vulcanised corner gasket for GE1305S	6			
AC2608AR	Clips fissaggio fermavetri	Clips for glazing bead	var.			
<b>GUARNIZIONI*</b>		<b>GASKETS*</b>				
Cod.	Descrizione	Description	n°	Dim.		
GU2036	Piattina adesiva morbida esterno vetro	Soft adhesive shim for external window	1	2xLT+12xHT		
GU2907TT	Guarnizione sotto vetro	Under glass gasket	1	2xLT+12xHT		
GP0095	Guarnizione interna vetro	Internal glass gasket	1	2xLT+12xHT		
GE2905S	Guarnizione superiore ante	Gasket for upper sash	1	2xLT		
GE1305S	Guarnizione perimetrale ante	Gasket for side sash	1	2xLT+6xHT		
GE1142	Guarnizione labirinto centrale	Gasket for central labyrinth	1	8xHT		
GU1387	Spazzolino verticale labirinto	Vertical labyrinth brush + adhesive	1	8xHT		
* le dimensioni delle guarnizioni sono indicative e devono essere aumentate del 10% per adattamenti e ritiri del materiale nel tempo						
* the gasket dimensions are indicative and have to be increased by 10% owing to adaptation and contractions of the material over time						

↳	↳	↳	↳	↳	↳
---	---	---	---	---	---

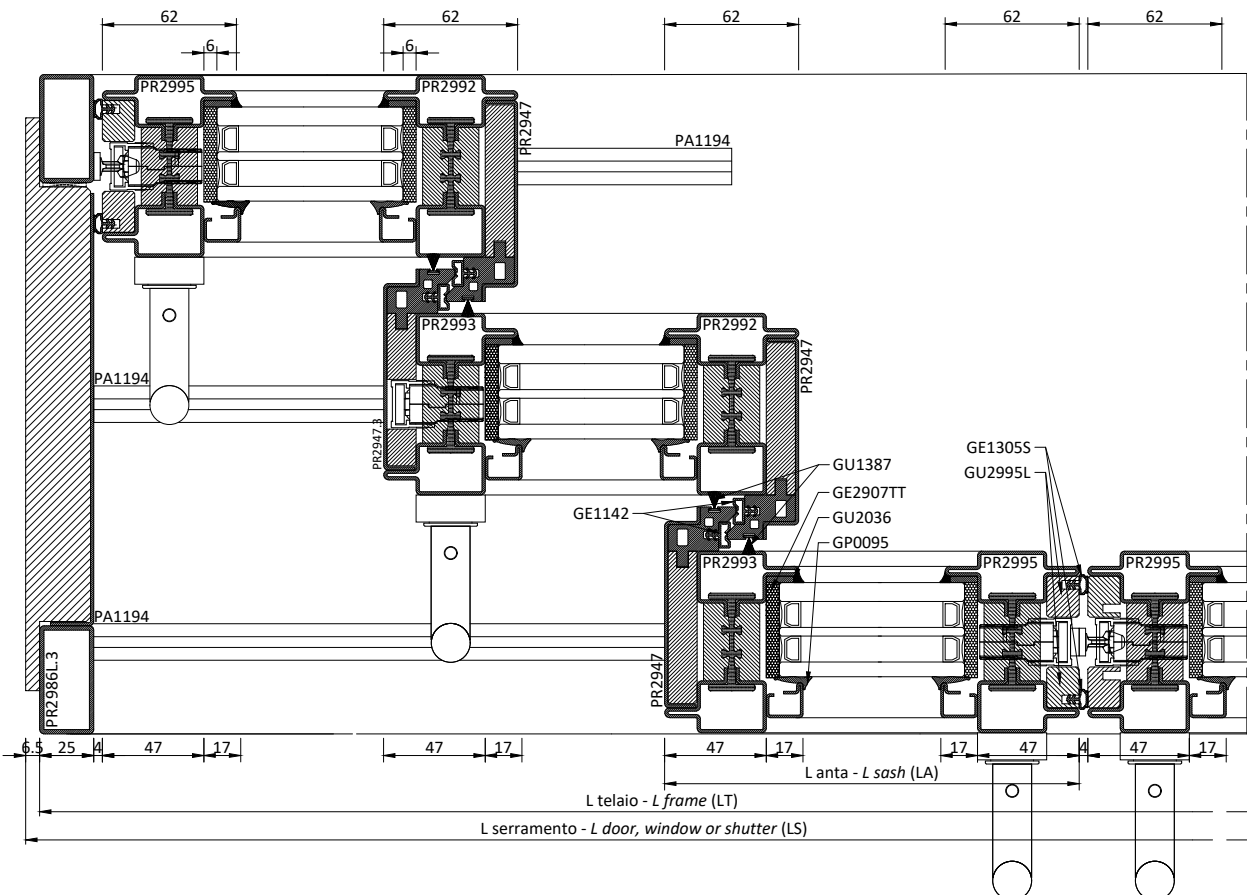
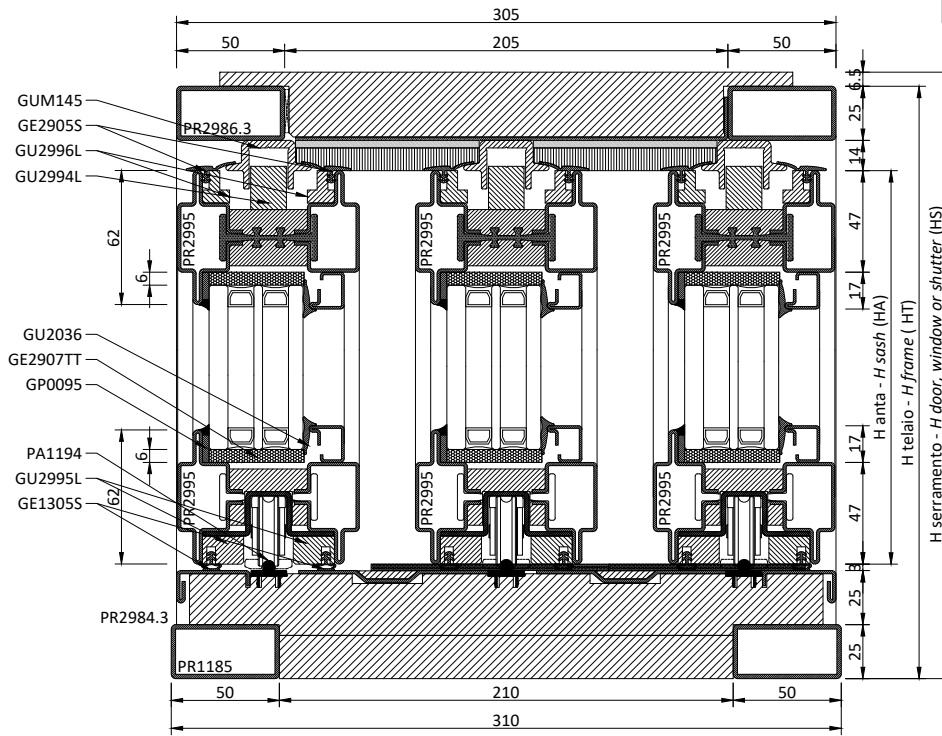

PROFILI		PROFILES			
Cod.	Descrizione	Description	n°	Dim.	Taglio/Cutting
<b>Telaio</b>		<b>Frame</b>			
PR2986.3	Profilo 50x25	Profile 50x25	2	LT	90 90
	Profilo palastico	Plastic profile	1	LT	90 90
	Profilo centrale a "L"	"L" profile	2	LT/6+26	90 90
	Profilo centrale a "C"	"C" profile	2	LT/6-31	90 90
	Profilo centrale a "L"	"L" profile	1	LT/3-1	90 90
PR2986L.3	Profilo 50x25	Profile 50x25	4	HT-25	90 90
	Profilo palastico	Plastic profile	2	HT-25	90 90
	Profilo centrale a "L"	"L" profile	2	HT-25	90 90
PR1185	Tubo in acciaio 50x25 mm	50x25 mm steel tube	2	LT-50	90 90
	Estruso centrale di unione	Central extrusion junction	1	LT-50	90 90
PR2984.3	Telaio base - copertina esterna (Part. A)	Lower frame - external cover (Detail A)	2	LT/3-27	90 90
	Telaio base - copertina interna (Part. A)	Lower frame - internal cover (Detail A)	1	LT-50	90 90
	Telaio base - copertina centrale (Part. B)	Lower frame - central cover (Detail B)	2	LT/6-24	90 90
	Telaio base - copertina centrale (Part. B)	Lower frame - central cover (Detail B)	2	LT/6-59	90 90
	Telaio base - copertina centrale (Part. B)	Lower frame - central cover (Detail B)	2	LT/3-55	90 90
	Telaio base - copertina esterna (Part. E)	Lower frame - external cover (Detail E)	1	LT/3+4	90 90
	Telaio base - profilo poliammide di supporto guide	Lower frame - polyamide profile of rails	1	LT-50	90 90
<b>Guide</b>		<b>Rail</b>			
GUM145	Profilo guida superiore anta mobile	Upper rail of sliding sash	1	LT-50	90 90
GUM145	Profilo guida superiore anta mobile	Upper rail of sliding sash	4	LT/3	90 90
PA1194	Profilo guida inferiore	Lower profile	1	LT-50	90 90
PA1194	Profilo guida inferiore	Lower profile	4	LT/3-30	90 90
<b>Anta</b>		<b>Sash</b>			
PR2995	Profilo zoccolo	Bottom rail profile	12	LT/6+31	45 45
	Profilo zoccolo	Bottom rail profile	4	HT-92	45 45
PR2992	Profilo a "T"	"T" profile	4	HT-92	45 45
PR2993	Profilo a "Z"	"Z" profile	4	HT-92	45 45
PR2947	Profilo labirinto centrale - anta mobile (Part. 1)	Central labyrinth profile - sliding sash (Detail 1)	6	HT-92	90 90
	Profilo labirinto centrale - anta mobile (Part. 2-3)	Central labyrinth profile - sliding sash (Detail 2)	6	HT-132	90 90
PR2947.3	Profilo labirinto centrale - anta mobile (Part. 1)	Central labyrinth profile - sliding sash (Detail 1)	2	HT-92	90 90
	Profilo labirinto centrale - anta mobile (Part. 2-3-4)	Central labyrinth profile - sliding sash (Detail 2)	2	HT-132	90 90
GU2995L	Profilo plastico porta guarnizione perimetrale	Plastic profile for rebate gasket support	8	HT-92	45 45
	Profilo plastico porta guarnizione perimetrale	Plastic profile for rebate gasket support	4	LT/6+16	45 90
	Profilo plastico porta guarnizione perimetrale	Plastic profile for rebate gasket support	4	LT/6+16	90 45
	Profilo plastico porta guarnizione perimetrale	Plastic profile for rebate gasket support	4	LT/6+1	90 90
GU2996L	Profilo plastico porta guarnizione superiore	Plastic profile for rebate gasket support	4	LT/6+16	90 45
	Profilo plastico porta guarnizione superiore	Plastic profile for rebate gasket support	4	LT/6+16	45 90
	Profilo plastico porta guarnizione superiore	Plastic profile for rebate gasket support	4	LT/6+1	90 90
GU2994L	Pattino di scorrimento anta mobile e fissa	Runner for sliding and fixed sash	6	LT/6+26	90 90
<b>Fermavetri</b>		<b>Glazing beads</b>			
PR2606	Profilo fermavetro	Glazing bead profile	6	LT/6-63	45 45
	Profilo fermavetro	Glazing bead profile	6	HT-186	45 45
<b>Vetri</b>		<b>Glass unit</b>			
	Vetrocamera	Double glazing	2	(LT/6-75) × (HT-198)	
<b>ACCESSORI</b>		<b>HARDWARE</b>			
Cod.	Descrizione	Description	n°	Note/Notes	
AC2995R.xx	Kit piastri di giunzione telaio esterno PR2986	Kit of external frame junction plates PR2986	4		
AG2992L.EF	Rostro aggiuntivo	Additional hook bolt	opz.		
AG2996F3.xx	Kit alzante scorrevole	Lift and slide kit	1		
ACV__	Maniglione	Large handle	6		
AC2995.1	Kit squadrette di giunzione ante	Corner joint kit Sashes	4		
AC2995.2	Kit squadrette di giunzione ante	Corner joint kit Sashes	2		
AG2989L.EF	Prolunga superiore cremonese	Upper cremonese extension	2	> 2908	
AG2989C	Profilo di copertura aggiuntivo	Additional covering profile	2	> 2908	
AC1305G	Angolo vulcanizzato per GE1305S	Vulcanised corner gasket for GE1305S	6		
AC2608AR	Clips fissaggio fermavetri	Clips for glazing bead	var.		
<b>GUARNIZIONI*</b>		<b>GASKETS*</b>			
Cod.	Descrizione	Description	n°	Dim.	
GU2036	Piattina adesiva morbida esterno vetro	Soft adhesive shim for external window	1	2xLT+12xHT	
GU2907TT	Guarnizione sotto vetro	Under glass gasket	1	2xLT+12xHT	
GP0095	Guarnizione interna vetro	Internal glass gasket	1	2xLT+12xHT	
GE2905S	Guarnizione superiore ante	Gasket for upper sash	1	2xLT	
GE1305S	Guarnizione perimetrale ante	Gasket for side sash	1	2xLT+6xHT	
GE1142	Guarnizione labirinto centrale	Gasket for central labyrinth	1	8xHT	
GU1387	Spazzolino verticale labirinto	Vertical labyrinth brush + adhesive	1	8xHT	
* le dimensioni delle guarnizioni sono indicative e devono essere aumentate del 10% per adattamenti e ritiri del materiale nel tempo					
* the gasket dimensions are indicative and have to be increased by 10% owing to adaptation and contractions of the material over time					

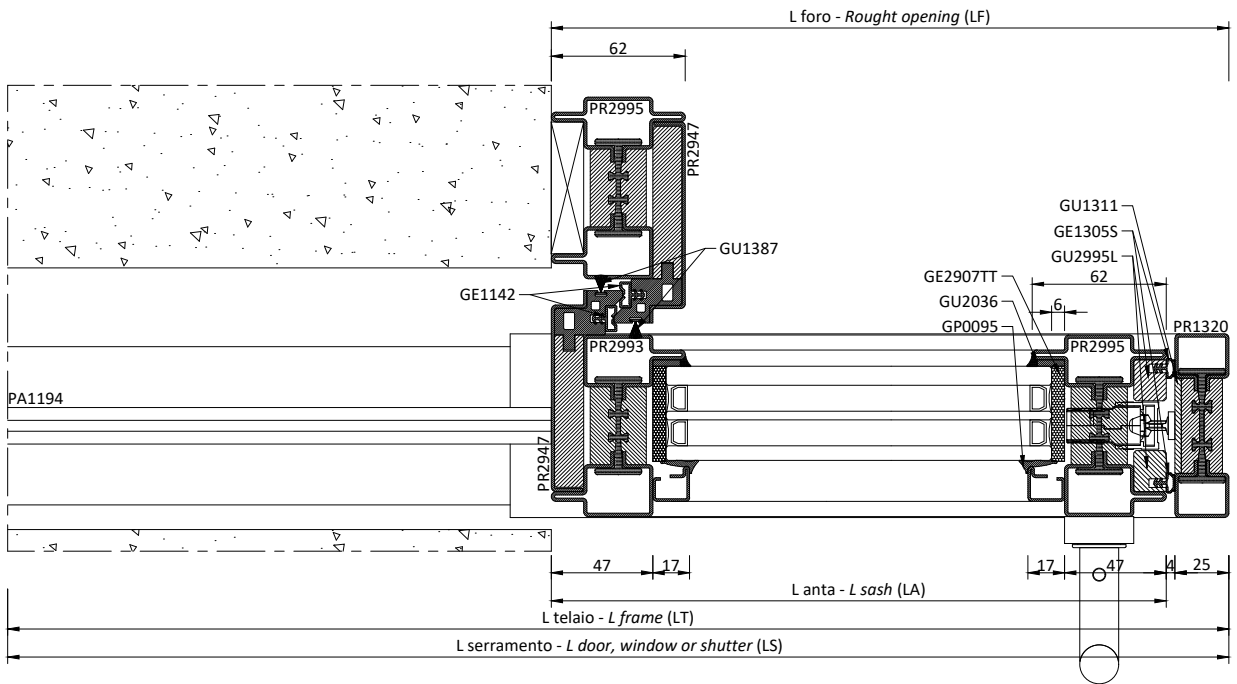
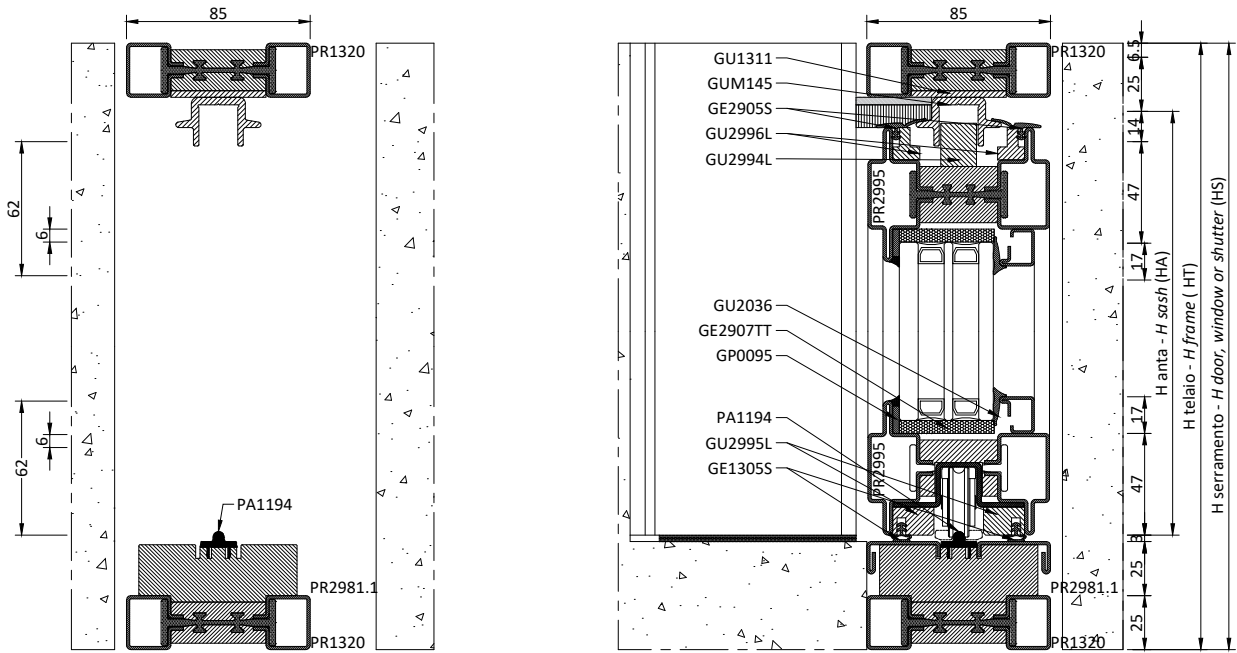
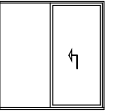



PROFILI		PROFILES			
Cod.	Descrizione	Description	n°	Dim.	Taglio/ Cutting
<b>Telaio</b> <b>Frame</b>					
PR1320	Profilo	Profile	2	2LF-34	90 90
	Profilo	Profile	1	HT	90 90
GU1311	profilo plastico spessore	plastic shim profile	1	2LF-56	90 90
	profilo plastico spessore	plastic shim profile	1	HT-44	90 90
PR2981.1	Telaio base - copertina esterna (Part. A)	Lower frame - external cover (Detail A)	1	LF-88	90 90
	Telaio base - copertina interna (Part. A)	Lower frame - internal cover (Detail A)	1	LF-6	90 90
	Telaio base - profilo poliammide di supporto guide	Lower frame - polyamide profile of rails	1	2LF-59	90 90
<b>Guide</b> <b>Rail</b>					
GUM145	Profilo guida superiore anta mobile	Upper rail of sliding sash	1	2LF-59	90 90
PA1194	Profilo guida inferiore	Lower profile	1	2LF-59	90 90
<b>Anta</b> <b>Sash</b>					
PR2995	Profilo zoccolo	Bottom rail profile	2	LF-29	45 45
	Profilo zoccolo	Bottom rail profile	2	HT-92	45 45
	Profilo zoccolo	Bottom rail profile	1	HT-53	90 90
PR2993	Profilo a "Z"	"Z" profile	1	HT-92	45 45
PR2947	Profilo labirinto centrale - anta mobile (Part. 1)	Central labyrinth profile - sliding sash (Detail 1)	1	HT-92	90 90
	Profilo labirinto centrale - anta mobile (Part. 2-3)	Central labyrinth profile - sliding sash (Detail 2)	1	HT-132	90 90
	Profilo labirinto centrale - anta fissa (Part. 1)	Central labyrinth profile - sliding sash (Detail 1)	1	HT-53	90 90
	Profilo labirinto centrale - anta fissa (Part. 2-3)	Central labyrinth profile - sliding sash (Detail 2)	1	HT-93	90 90
GU2995L	Profilo plastico porta guarnizione perimetrale	Plastic profile for rebate gasket support	2	HT-92	45 45
	Profilo plastico porta guarnizione perimetrale	Plastic profile for rebate gasket support	1	LF-44	45 90
	Profilo plastico porta guarnizione perimetrale	Plastic profile for rebate gasket support	1	LF-44	90 45
GU2996L	Profilo plastico porta guarnizione superiore	Plastic profile for rebate gasket support	1	LF-44	90 45
	Profilo plastico porta guarnizione superiore	Plastic profile for rebate gasket support	1	LF-44	45 90
GU2994L	Pattino di scorrimento anta mobile e fissa	Runner for sliding and fixed sash	1	LF-34	90 90
<b>Fermavetri</b> <b>Glazing beads</b>					
PR2606	Profilo fermavetro	Glazing bead profile	4	LF-123	45 45
	Profilo fermavetro	Glazing bead profile	4	HT-186	45 45
<b>Vetri</b> <b>Glass unit</b>					
	Vetrocamera	Double glazing	2	(LF-135) x (HT-198)	
<b>ACCESSORI</b> <b>HARDWARE</b>					
Cod.	Descrizione	Description	n°	Note/Notes	
AC1730I	Squadretta di unione per telaio PR1320	Corner joint for frame PR1320	2		
AG2992L.AB	Rostro aggiuntivo	Additional hook bolt	opz.		
AG2996J7S1.xx	Kit alzante scorrevole	Lift and slide kit	1		
ACV ____	Maniglione	Large handle	1		
AC2995.1	Kit squadrette di giunzione ante	Corner joint kit Sashes	1		
AG2989L.AB	Prolunga superiore cremonese	Upper cremonese extension	1	> 2908	
AG2989C	Profilo di copertura aggiuntivo	Additional covering profile	1	> 2908	
AC1305G	Angolo vulcanizzato per GE1305S	Vulcanised corner gasket for GE1305S	2		
AC2608AR	Clips fissaggio fermavetri	Clips for glazing bead	var.		
<b>GUARNIZIONI*</b> <b>GASKETS*</b>					
Cod.	Descrizione	Description	n°	Dim.	
GU2036	Piattina adesiva morbida esterno vetro	Soft adhesive shim for external window	1	2xLF+ 2xHT	
GU2907TT	Guarnizione sotto vetro	Under glass gasket	1	2xLF+ 2xHT	
GP0095	Guarnizione interna vetro	Internal glass gasket	1	2xLF+ 2xHT	
GE2905S	Guarnizione superiore ante	Gasket for upper sash	1	2xLF	
GE1305S	Guarnizione perimetrale ante	Gasket for side sash	1	2xLF+ 2xHT	
GE1142	Guarnizione labirinto centrale	Gasket for central labyrinth	1	2xHT	
GU1387	Spazzolino verticale labirinto	Vertical labyrinth brush + adhesive	1	2xHT	
* le dimensioni delle guarnizioni sono indicative e devono essere aumentate del 10% per adattamenti e ritiri del materiale nel tempo					
* the gasket dimensions are indicative and have to be increased by 10% owing to adaptation and contractions of the material over time					

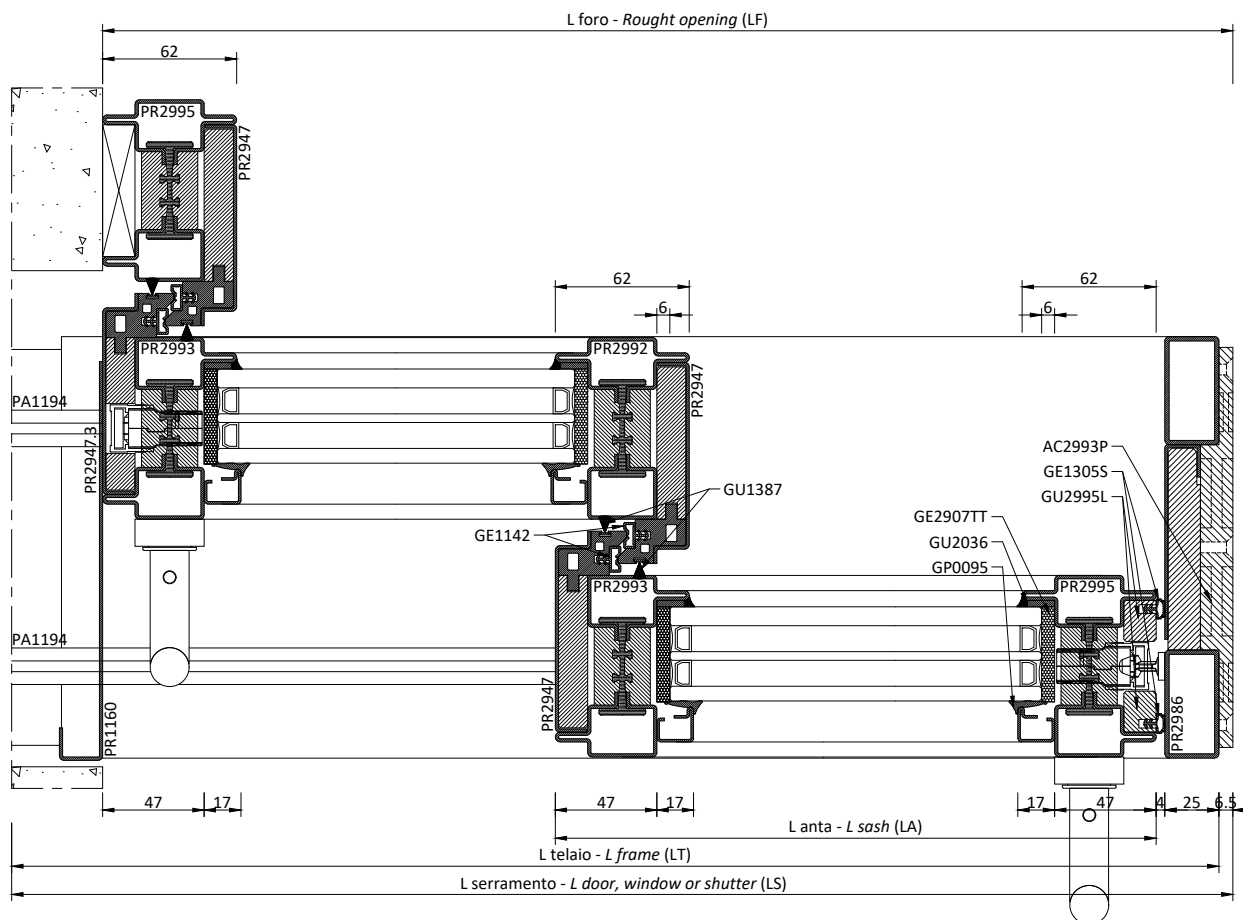
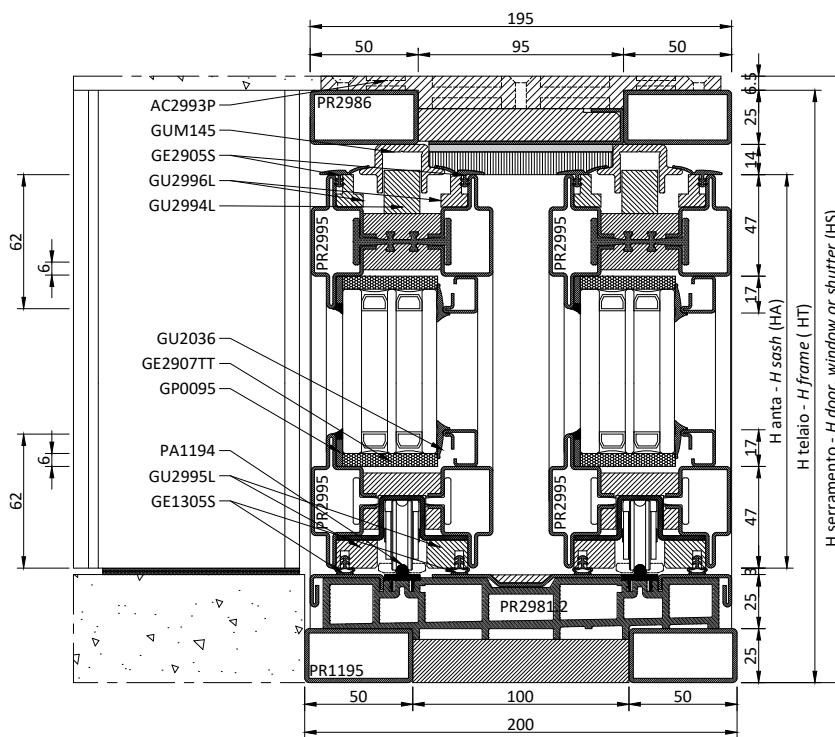
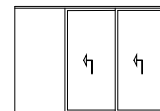

PROFILI		PROFILES			
Cod.	Descrizione	Description	n°	Dim.	Taglio/Cutting
<b>Telaio</b>		<b>Frame</b>			
PR2986	Profilo 50x25	Profile 50x25	2	LT	90 90
	Profilo 50x25	Profile 50x25	4	HT-25	90 90
	Profilo plastico	Plastic profile	2	LT/2	90 90
	Profilo plastico	Plastic profile	2	HT-25	90 90
	Profilo centrale a "C"	"C" profile	2	LT/2-3	90 90
PR1195	Profilo centrale a "C"	"C" profile	2	HT-25	90 90
	Tubo in acciaio 50x25 mm	50x25 mm steel tube	2	LT-50	90 90
PR2983	Estruso centrale di unione	Central extrusion junction	1	LT-50	90 90
	Telaio base - copertina esterna (Part. A)	Lower frame - external cover (Detail A)	1	LT/2-25	90 90
	Telaio base - copertina interna (Part. A)	Lower frame - internal cover (Detail A)	1	LT-50	90 90
	Telaio base - copertina centrale (Part. B)	Lower frame - central cover (Detail B)	1	LT/2-53	90 90
	Telaio base - copertina esterna (Part. C)	Lower frame - external cover (Detail C)	1	LT/2-25	90 90
	Telaio base - profilo poliammide di supporto guide	Lower frame - polyamide profile of rails	1	LT-50	90 90
<b>Guide</b>		<b>Rail</b>			
GUM145	Profilo guida superiore anta mobile	Upper rail of sliding sash	1	LT-50	90 90
	Profilo guida superiore anta fissa	Upper rail of fixed sash	1	LT/2+3	90 90
PA1194	Profilo guida inferiore	Lower profile	1	LT-50	90 90
<b>Anta</b>		<b>Sash</b>			
PR2995	Profilo zoccolo	Bottom rail profile	4	LT/2+2	45 45
	Profilo zoccolo	Bottom rail profile	2	HT-92	45 45
PR2992	Profilo a "T"	"T" profile	1	HT-92	45 45
PR2993	Profilo a "Z"	"Z" profile	1	HT-92	45 45
PR2947	Profilo labirinto centrale - anta mobile (Part. 1)	Central labyrinth profile - sliding sash (Detail 1)	1	HT-92	90 90
	Profilo labirinto centrale - anta mobile (Part. 2-3)	Central labyrinth profile - sliding sash (Detail 2)	1	HT-132	90 90
	Profilo labirinto centrale - anta fissa (Part. 1)	Central labyrinth profile - sliding sash (Detail 1)	1	HT-92	90 90
	Profilo labirinto centrale - anta fissa (Part. 2-3)	Central labyrinth profile - sliding sash (Detail 2)	1	HT-132	90 90
GU2995L	Profilo plastico porta guarnizione perimetrale	Plastic profile for rebate gasket support	4	HT-92	45 45
	Profilo plastico porta guarnizione perimetrale	Plastic profile for rebate gasket support	2	LT/2-13	45 90
GU2996L	Profilo plastico porta guarnizione superiore	Plastic profile for rebate gasket support	2	LT/2-13	90 45
	Profilo plastico porta guarnizione superiore	Plastic profile for rebate gasket support	2	LT/2-13	45 90
GU2994L	Pattino di scorrimento anta mobile e fissa	Runner for sliding and fixed sash	2	LT/2-3	90 90
GU2905	Estruso di compensazione	Compensation extrusion	1	HT-107	90 90
	Estruso di compensazione	Compensation extrusion	1	LT/2-78	90 90
<b>Fermavetri</b>		<b>Glazing beads</b>			
PR2606	Profilo fermavetro	Glazing bead profile	4	LT/2-92	45 45
	Profilo fermavetro	Glazing bead profile	4	HT-186	45 45
<b>Vetri</b>		<b>Glass unit</b>			
	Vetrocamera	Double glazing	2	(LT/2-104) x (HT-198)	
<b>ACCESSORI</b>		<b>HARDWARE</b>			
Cod.	Descrizione	Description	n°	Note/Notes	
AC2995R.xx	Kit piastrelle di giunzione telaio esterno PR2986	Kit of external frame junction plates PR2986	4		
AC2993P	Accessorio assemblaggio telaio	Frame assemblage accessory	var.		
CV5403I	Rondella in acciaio inox/epdm	Stainless steel/vulcanised epdm washer	var.		
AG2992L.AB	Rostro aggiuntivo	Additional hook bolt	opz.		
AG2996J7A.xx	Kit alzante scorrevole	Lift and slide kit	1		
ACV___	Maniglione	Large handle	1		
AC2995.1	Kit squadrette di giunzione ante	Corner joint kit Sashes	2		
AG2989L.AB	Prolunga superiore cremonese	Upper cremonese extension	opz.	> 2908	
AG2989C	Profilo di copertura aggiuntivo	Additional covering profile	opz.	> 2908	
AC1305G	Angolo vulcanizzato per GE1305S	Vulcanised corner gasket for GE1305S	4		
AC2608AR	Clips fissaggio fermavetri	Clips for glazing bead	var.		
<b>GUARNIZIONI*</b>		<b>GASKETS*</b>			
Cod.	Descrizione	Description	n°	Dim.	
GU2036	Piattina adesiva morbida esterno vetro	Soft adhesive shim for external window	1	2xLT+4xHT	
GU2907TT	Guarnizione sotto vetro	Under glass gasket	1	2xLT+4xHT	
GP0095	Guarnizione interna vetro	Internal glass gasket	1	2xLT+4xHT	
GE2905S	Guarnizione superiore ante	Gasket for upper sash	1	2xLT	
GE1305S	Guarnizione perimetrale ante	Gasket for side sash	1	2xLT+4xHT	
GE1142	Guarnizione labirinto centrale	Gasket for central labyrinth	1	2xHT	
GU1387	Spazzolino verticale labirinto	Vertical labyrinth brush + adhesive	1	2xHT	

\* Le dimensioni delle guarnizioni sono indicative e devono essere aumentate del 10% per adattamenti e ritiri del materiale nel tempo

\* the gasket dimensions are indicative and have to be increased by 10% owing to adaptation and contraction of the material over time



PROFILI		PROFILES				
Cod.	Descrizione	Description	n°	Dim.	Taglio/Cutting	
<b>Telaio</b>		<b>Frame</b>				
PR2986S3	Profilo 50x25	Profile 50x25	2	4LF/3+44	90	90
	Profilo plastico	Plastic profile	1	4LF/3+44	90	90
	Profilo centrale a "B"	"B" profile	1	LF/3+27	90	90
	Profilo centrale a "C"	"C" profile	2	LF/3-30	90	90
	Profilo centrale a "L"	"L" profile	1	2LF/3+41	90	90
PR2986L.3	Profilo 50x25	Profile 50x25	2	HT-25	90	90
	Estruso centrale di unione	Central extrusion junction	1	HT-25	90	90
	Profilo centrale a "L"	"L" profile	1	HT-25	90	90
PR1185	Tubo in acciaio 50x25 mm	50x25 mm steel tube	2	4LF/3+19	90	90
	Estruso centrale di unione	Central extrusion junction	1	4LF/3+19	90	90
PR2981.3	Telaio base - copertina esterna (Part. A)	Lower frame - external cover (Detail A)	1	LF/3-62	90	90
	Telaio base - copertina interna (Part. A)	Lower frame - internal cover (Detail A)	1	LF-6	90	90
	Telaio base - copertina centrale (Part. B)	Lower frame - central cover (Detail B)	1	LF/3-9	90	90
	Telaio base - copertina centrale (Part. B)	Lower frame - central cover (Detail B)	1	2LF/3-39	90	90
	Telaio base - copertina esterna (Part. C)	Lower frame - external cover (Detail C)	1	LF/3-31	90	90
	Telaio base - copertina esterna (Part. E)	Lower frame - external cover (Detail E)	1	LF/3+5	90	90
	Telaio base - profilo poliammide di supporto guide	Lower frame - polyamide profile of rails	1	4LF/3+19	90	90
<b>Guide</b>		<b>Rail</b>				
GUM145	Profilo guida superiore anta mobile	Upper rail of sliding sash	1	4LF/3+19	90	90
GUM145	Profilo guida superiore anta mobile	Upper rail of sliding sash	1	LF+42	90	90
GUM145	Profilo guida superiore anta mobile	Upper rail of sliding sash	1	2LF/3+73	90	90
PA1194	Profilo guida inferiore	Lower profile	1	4LF/3+19	90	90
PA1194	Profilo guida inferiore	Lower profile	1	LF+15	90	90
PA1194	Profilo guida inferiore	Lower profile	1	2LF/3+45	90	90
<b>Anta</b>		<b>Sash</b>				
PR2995	Profilo zoccolo	Bottom rail profile	6	LF/3+31,5	45	45
	Profilo zoccolo	Bottom rail profile	1	HT-92	45	45
	Profilo zoccolo	Bottom rail profile	1	HT-53	90	90
PR2992	Profilo a "T"	"T" profile	2	HT-92	45	45
PR2993	Profilo a "Z"	"Z" profile	3	HT-92	45	45
PR2947	Profilo labirinto centrale - anta mobile (Part. 1)	Central labyrinth profile - sliding sash (Detail 1)	3	HT-92	90	90
	Profilo labirinto centrale - anta mobile (Part. 2-3)	Central labyrinth profile - sliding sash (Detail 2)	3	HT-132	90	90
	Profilo labirinto centrale - anta fissa (Part. 1)	Central labyrinth profile - sliding sash (Detail 1)	1	HT-53	90	90
	Profilo labirinto centrale - anta fissa (Part. 2-3)	Central labyrinth profile - sliding sash (Detail 2)	1	HT-93	90	90
PR2947.3	Profilo labirinto centrale - anta mobile (Part. 1)	Central labyrinth profile - sliding sash (Detail 1)	2	HT-92	90	90
	Profilo labirinto centrale - anta mobile (Part. 2-3-4)	Central labyrinth profile - sliding sash (Detail 2)	2	HT-132	90	90
PR1180	Stampato di finitura	Cover profile	1	HT-92	90	90
GU2995L	Profilo plastico porta guarnizione perimetrale	Plastic door profile perimeter gasket	2	HT-92	45	45
	Profilo plastico porta guarnizione perimetrale	Plastic door profile perimeter gasket	1	LF/3+16	45	90
	Profilo plastico porta guarnizione perimetrale	Plastic door profile perimeter gasket	1	LF/3+16	90	45
	Profilo plastico porta guarnizione perimetrale	Plastic door profile perimeter gasket	4	LF/3+1	90	90
GU2996L	Profilo plastico porta guarnizione superiore	Plastic door profile upper gasket	1	LF/3+16	90	45
	Profilo plastico porta guarnizione superiore	Plastic door profile upper gasket	1	LF/3+16	45	90
	Profilo plastico porta guarnizione superiore	Plastic door profile upper gasket	4	LF/3+16	90	90
GU2994L	Pattino di scorrimento anta mobile e fissa	Runner for sliding and fixed sash	3	LF/3+16	90	90
<b>Fermavetri</b>		<b>Glazing beads</b>				
PR2606	Profilo fermavetro	Glazing bead profile	6	LF/3-62,5	45	45
	Profilo fermavetro	Glazing bead profile	6	HT-186	45	45
<b>Vetri</b>		<b>Glass unit</b>				
	Vetrocamera	Double glazing	2	(LF/3-74,5)×(HT-198)		
<b>ACCESSORI</b>		<b>HARDWARE</b>				
Cod.	Descrizione	Description	n°	Note/Notes		
AG2992L.AB	Rostrò aggiuntivo	Additional hook bolt	opz.			
AG2996 753..xx	Kit alzante scorrevole	Lift and slide kit	1			
ACV	Maniglione	Large handle	3			
AC2995.1	Kit squadrette di giunzione ante	Corner joint kit Sashes	1			
AC2995.2	Kit squadrette di giunzione ante	Corner joint kit Sashes	2			
AG2989L.AB	Prolunga superiore cremonese	Upper cremonese extention	opz.	> 2908		
AG2989C	Profilo di copertura aggiuntivo	Additional covering profile	opz.	> 2908		
AC1305G	Angolo vulcanizzato per GE1305S	Vulcanised corner gasket for GE1305S	2			
AC2608AR	Clips fissaggio fermavetri	Clips for glazing bead	var.			
<b>GUARNIZIONI*</b>		<b>GASKETS*</b>				
Cod.	Descrizione	Description	n°	Dim.		
GU2036	Piattina adesiva morbida esterno vetro	Soft adhesive shim for external window	1	2xLF+6xHT		
GU2907TT	Guarnizione sotto vetro	Under glass gasket	1	2xLF+6xHT		
GP0095	Guarnizione interna vetro	Internal glass gasket	1	2xLF+6xHT		
GE2905S	Guarnizione superiore ante	Gasket for upper sash	1	2xLF		
GE1305S	Guarnizione perimetrale ante	Gasket for side sash	1	2xLF+2xHT		
GE1142	Guarnizione labirinto centrale	Gasket for central labyrinth	1	6xHT		
GU1387	Spazzolino verticale labirinto	Vertical labyrinth brush + adhesive	1	6xHT		
* Le dimensioni delle guarnizioni sono indicative e devono essere aumentate del 10% per adattamenti e ritiri del materiale nel tempo						
* the gasket dimensions are indicative and have to be increased by 10% owing to adaptation and contraction of the material over time						

h	p
---	---

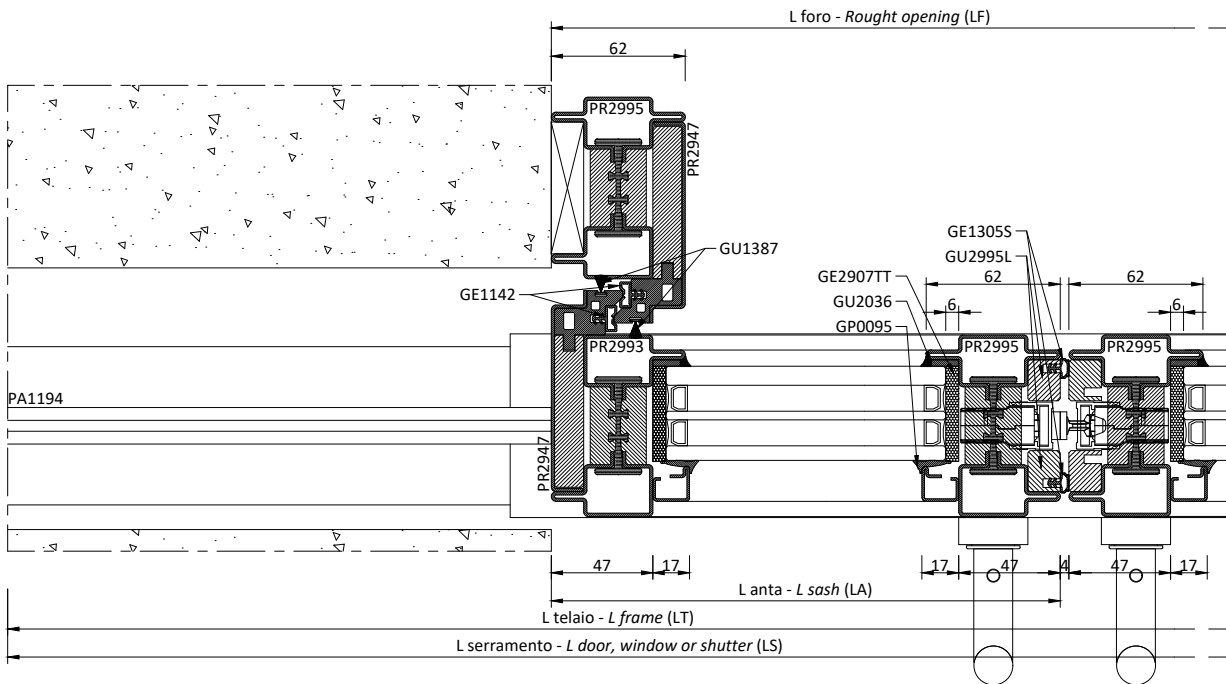
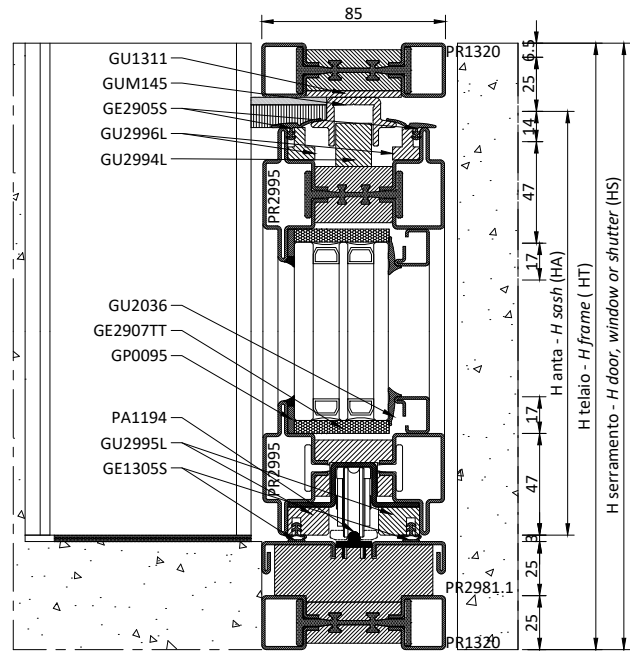
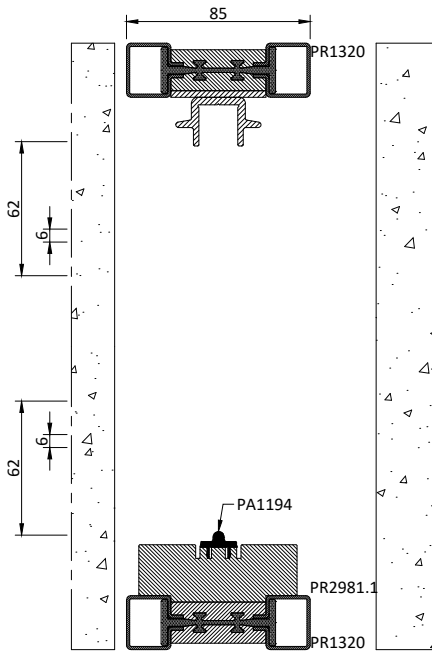

<b>PROFILI</b>		<b>PROFILES</b>			
Cod.	Descrizione	Description	n°	Dim.	Taglio/Cutting
<b>Telaio</b>		<b>Frame</b>			
PR1320	Profilo 50x25	Profile 50x25	2	2LF-14	90 90
GU1311	Profilo plastico spessore	Plastic shim profile	1	2LF-14	90 90
PR2981.1	Telaio base - copertina esterna (Part. A)	Lower frame - external cover (Detail A)	1	LF-126	90 90
	Telaio base - copertina interna (Part. A)	Lower frame - internal cover (Detail A)	1	LF+38	90 90
	Telaio base - profilo poliammide di supporto guide	Lower frame - polyamide profile of rails	1	2LF-14	90 90
<b>Guide</b>		<b>Rail</b>			
GUM145	Profilo guida superiore anta mobile	Upper rail of sliding sash	1	LF	90 90
PA1194	Profilo guida inferiore	Lower profile	1	LF	90 90
<b>Anta</b>		<b>Sash</b>			
PR2995	Profilo zoccolo	Bottom rail profile	4	LF/2-2	45 45
	Profilo zoccolo	Bottom rail profile	2	HT-92	45 45
	Profilo zoccolo	Bottom rail profile	2	HT-53	90 90
PR2993	Profilo a "Z"	"Z" profile	2	HT-92	45 45
PR2947	Profilo labirinto centrale - anta mobile (Part. 1)	Central labyrinth profile - sliding sash (Detail 1)	2	HT-92	90 90
	Profilo labirinto centrale - anta mobile (Part. 2-3)	Central labyrinth profile - sliding sash (Detail 2)	2	HT-132	90 90
	Profilo labirinto centrale - anta fissa (Part. 1)	Central labyrinth profile - sliding sash (Detail 1)	2	HT-53	90 90
	Profilo labirinto centrale - anta fissa (Part. 2-3)	Central labyrinth profile - sliding sash (Detail 2)	2	HT-93	90 90
GU2995L	Profilo plastico porta guarnizione perimetrale	Plastic door profile perimeter gasket	4	HT-92	45 45
	Profilo plastico porta guarnizione perimetrale	Plastic door profile perimeter gasket	2	LF/2-17	45 90
	Profilo plastico porta guarnizione perimetrale	Plastic door profile perimeter gasket	2	LF/2-17	90 45
GU2996L	Profilo plastico porta guarnizione superiore	Plastic door profile upper gasket	2	LF/2-17	90 45
	Profilo plastico porta guarnizione superiore	Plastic door profile upper gasket	2	LF/2-17	45 90
GU2994L	Pattino di scorrimento anta mobile e fissa	Runner for sliding and fixed sash	2	LF/2-7	90 90
<b>Fermavetri</b>		<b>Glazing beads</b>			
PR2606	Profilo fermavetro	Glazing bead profile	4	LF/2-96	45 45
	Profilo fermavetro	Glazing bead profile	4	HT-186	45 45
<b>Vetri</b>		<b>Glass unit</b>			
	Vetrocamera	Double glazing	2	(LF/2-108) x (HT-198)	
<b>ACCESSORI</b>		<b>HARDWARE</b>			
Cod.	Descrizione	Description	n°	Note/Notes	
AG2992L.EF	Rostro aggiuntivo	Additional hook bolt	opz.		
AG2996T1.xx	Kit alzante scorrevole	Lift and slide kit	1		
ACV__	Maniglione	Large handle	2		
AC2995.1	Kit squadrette di giunzione ante	Corner joint kit Sashes	2		
AG2989L.EF	Prolunga superiore cremonese	Upper cremonese extention	2	> 2908	
AG2989C	Profilo di copertura aggiuntivo	Additional covering profile	2	> 2908	
AC1305G	Angolo vulcanizzato per GE1305S	Vulcanised corner gasket for GE1305S	2		
AC2608AR	Clips fissaggio fermavetri	Clips for glazing bead	var.		
<b>GUARNIZIONI*</b>		<b>GASKETS*</b>			
Cod.	Descrizione	Description	n°	Dim.	
GU2036	Piattina adesiva morbida esterno vetro	Soft adhesive shim for external window	1	2xLF+ 4xHT	
GU2907TT	Guarnizione sotto vetro	Under glass gasket	1	2xLF+ 4xHT	
GPO095	Guarnizione interna vetro	Internal glass gasket	1	2xLF+ 4xHT	
GE2905S	Guarnizione superiore ante	Gasket for upper sash	1	2xLF	
GE1305S	Guarnizione perimetrale ante	Gasket for side sash	1	2xLF+ 2xHT	
GE1142	Guarnizione labirinto centrale	Gasket for central labyrinth	1	4xHT	
GU1387	Spazzolino verticale labirinto	Vertical labyrinth brush + adhesive	1	4xHT	
* le dimensioni delle guarnizioni sono indicative e devono essere aumentate del 10% per adattamenti e ritiri del materiale nel tempo					
* the gasket dimensions are indicative and have to be increased by 10% owing to adaptation and contractions of the material over time					

4	4	4	4
---	---	---	---

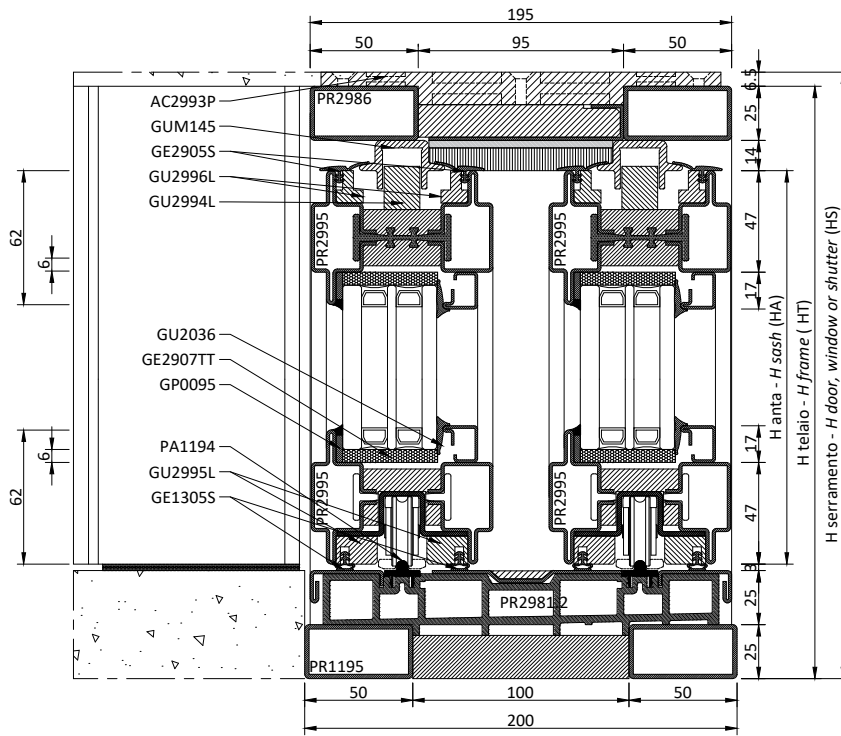

L foro - Rough opening (LF)

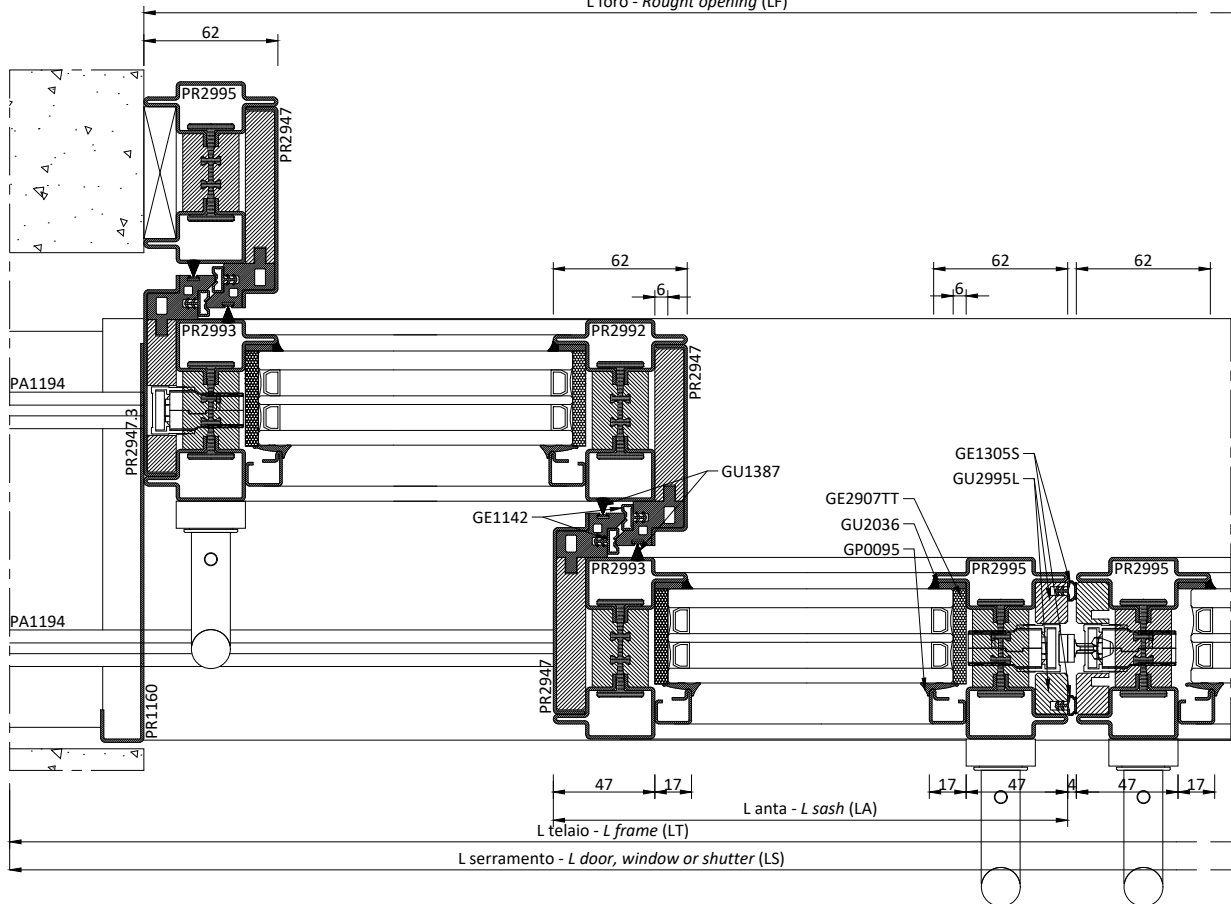



PROFILI		PROFILES			
Cod.	Descrizione	Description	n°	Dim.	Taglio/Cutting
<b>Telaio</b>		<b>Frame</b>			
PR2986	Profilo 50x25	Profile 50x25	2	3LF/2+86	90 90
	Profilo plastico	Plastic profile	2	LF/2+42	90 90
	Profilo plastico	Plastic profile	1	LF/2+2	90 90
	Profilo centrale a "C"	"C" profile	2	LF/2+39	90 90
	Profilo centrale a "C"	"C" profile	1	LF/2-1	90 90
PR1195	Tubo in acciaio 50x25 mm	50x25 mm steel tube	2	3LF/2+86	90 90
	Profilo plastico	Plastic profile	1	3LF/2+86	90 90
PR2981.2	Telaio base - copertina esterna (Part. A)	Lower frame - external cover (Detail A)	2	LF/4-64	90 90
	Telaio base - copertina interna (Part. A)	Lower frame - internal cover (Detail A)	1	LF+38	90 90
	Telaio base - copertina centrale (Part. B)	Lower frame - central cover (Detail B)	2	LF/4-10	90 90
	Telaio base - copertina esterna (Part. C)	Lower frame - external cover (Detail C)	1	LF/2+2	90 90
	Telaio base - profilo poliammide di supporto guide	Lower frame - polyamide profile of rails	1	3LF/2+86	90 90
<b>Guide</b>		<b>Rail</b>			
GUM145	Profilo guida superiore anta mobile	Upper rail of sliding sash	1	3LF/2+86	90 90
GUM145	Profilo guida superiore anta mobile	Upper rail of sliding sash	2	LF/2+69	90 90
PA1194	Profilo guida inferiore	Lower profile	1	3LF/2+86	90 90
PA1194	Profilo guida inferiore	Lower profile	2	LF/2+42	90 90
<b>Anta</b>		<b>Sash</b>			
PR2995	Profilo zoccolo	Bottom rail profile	8	LF/4+30	45 45
	Profilo zoccolo	Bottom rail profile	2	HT-92	45 45
	Profilo zoccolo	Bottom rail profile	2	HT-53	90 90
PR2992	Profilo a "T"	"T" profile	2	HT-92	45 45
PR2993	Profilo a "Z"	"Z" profile	4	HT-92	45 45
PR2947	Profilo labirinto centrale - anta mobile (Part. 1)	Central labyrinth profile - sliding sash (Detail 1)	4	HT-92	90 90
	Profilo labirinto centrale - anta mobile (Part. 2-3)	Central labyrinth profile - sliding sash (Detail 2)	4	HT-132	90 90
	Profilo labirinto centrale - anta fissa (Part. 1)	Central labyrinth profile - sliding sash (Detail 1)	2	HT-53	90 90
	Profilo labirinto centrale - anta fissa (Part. 2-3)	Central labyrinth profile - sliding sash (Detail 2)	2	HT-93	90 90
PR2947.3	Profilo labirinto centrale - anta mobile (Part. 1)	Central labyrinth profile - sliding sash (Detail 1)	2	HT-92	90 90
	Profilo labirinto centrale - anta mobile (Part. 2-3-4)	Central labyrinth profile - sliding sash (Detail 2)	2	HT-132	90 90
PR1160	Stampato di finitura	Cover profile	2	HT-92	90 90
GU2995L	Profilo plastico porta guarnizione perimetrale	Plastic profile for rebate gasket support	4	HT-92	45 45
	Profilo plastico porta guarnizione perimetrale	Plastic profile for rebate gasket support	2	LF/4+15	45 90
	Profilo plastico porta guarnizione perimetrale	Plastic profile for rebate gasket support	2	LF/4+15	90 45
	Profilo plastico porta guarnizione perimetrale	Plastic profile for rebate gasket support	4	LF/4	90 90
GU2996L	Profilo plastico porta guarnizione superiore	Plastic profile for rebate gasket support	2	LF/4+15	90 45
	Profilo plastico porta guarnizione superiore	Plastic profile for rebate gasket support	2	LF/4+15	45 90
	Profilo plastico porta guarnizione superiore	Plastic profile for rebate gasket support	4	LF/4	90 90
GU2994L	Pattino di scorrimento anta mobile e fissa	Runner for sliding and fixed sash	4	LF/4+25	90 90
<b>Fermavetri</b>		<b>Glazing beads</b>			
PR2606	Profilo fermavetro	Glazing bead profile	4	LF/4-64	45 45
	Profilo fermavetro	Glazing bead profile	4	HT-186	45 45
<b>Vetri</b>		<b>Glass unit</b>			
	Vetrocamera	Double glazing	2	(LF/4-76)×(HT-198)	
<b>ACCESSORI</b>		<b>HARDWARE</b>			
Cod.	Descrizione	Description	n°	Note/Notes	
AC2993P	Accessorio assemblaggio telaio	Frame assemblage accessory	var.		
CV5403I	Rondella in acciaio inox/epdm	Stainless steel/vulcanised epdm washer	var.		
AG2992L.EF	Rostro aggiuntivo	Additional hook bolt	opz.		
AG2996T2.xx	Kit alzanze scorrevole	Lift and slide kit	1		
ACV____	Maniglione	Large handle	4		
AC2995.1	Kit squadrette di giunzione ante	Corner joint kit Sashes	2		
AC2995.2	Kit squadrette di giunzione ante	Corner joint kit Sashes	2		
AG2989L.EF	Prolunga superiore cremonese	Upper cremonese extension	opz.	> 2908	
AG2989C	Profilo di copertura aggiuntivo	Additional covering profile	opz.	> 2908	
AC1305G	Angolo vulcanizzato per GE1305S	Vulcanised corner gasket for GE1305S	2		
AC2608AR	Clips fissaggio fermavetri	Clips for glazing bead	var.		
<b>GUARNIZIONI*</b>		<b>GASKETS*</b>			
Cod.	Descrizione	Description	n°	Dim.	
GU2036	Piattina adesiva morbida esterno vetro	Soft adhesive shim for external window	1	2xLF+8xHT	
GU2907TT	Guarnizione sotto vetro	Under glass gasket	1	2xLF+8xHT	
GP0095	Guarnizione interna vetro	Internal glass gasket	1	2xLF+8xHT	
GE2905S	Guarnizione superiore ante	Gasket for upper sash	1	2xLF	
GE1305S	Guarnizione perimetrale ante	Gasket for side sash	1	2xLF+2xHT	
GE1142	Guarnizione labirinto centrale	Gasket for central labyrinth	1	8xHT	
GU1387	Spazzolino verticale labirinto	Vertical labyrinth brush + adhesive	1	8xHT	
* le dimensioni delle guarnizioni sono indicative e devono essere aumentate del 10% per adattamenti e ritiri del materiale nel tempo					
* the gasket dimensions are indicative and have to be increased by 10% owing to adaptation and contractions of the material over time					

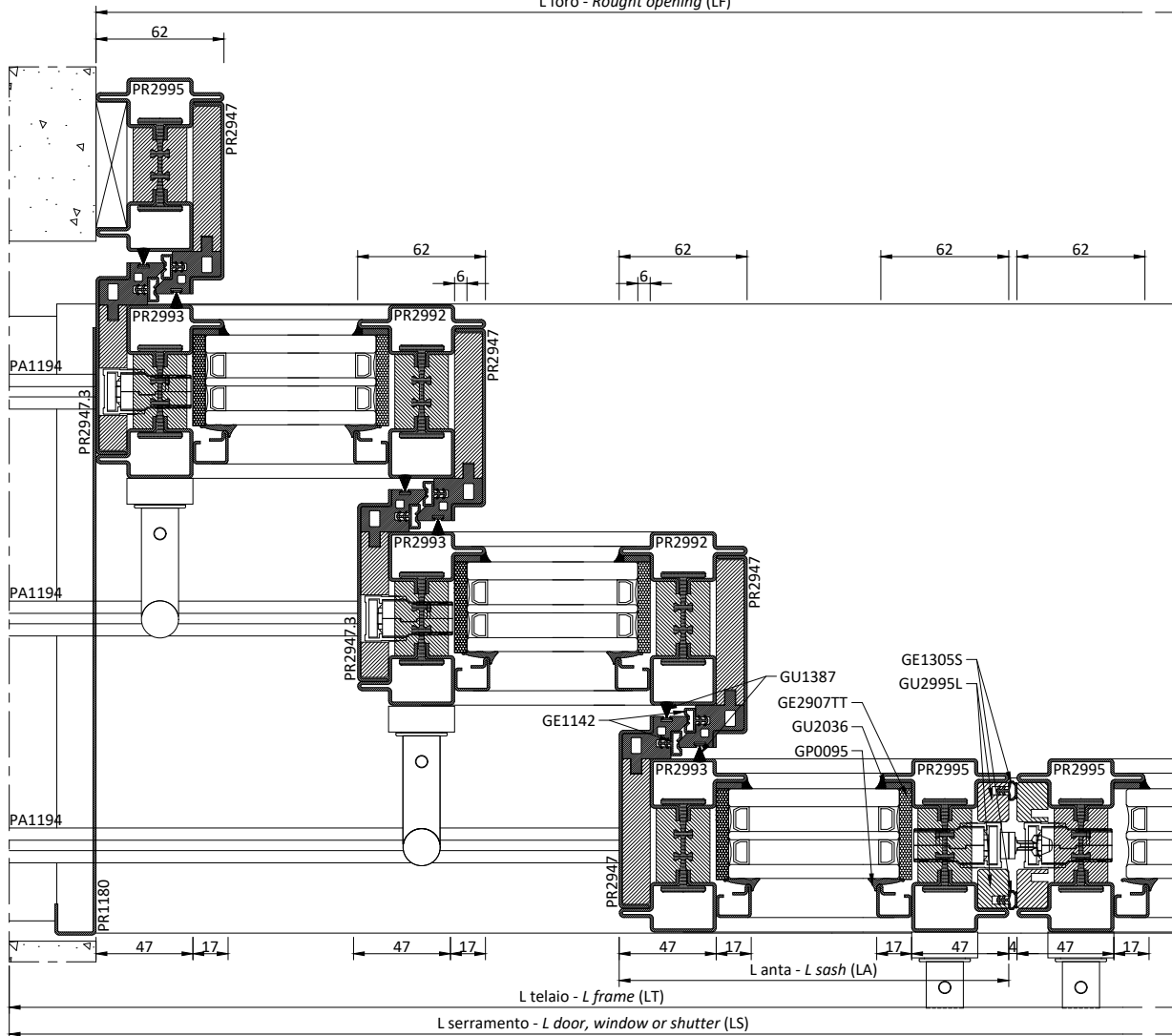
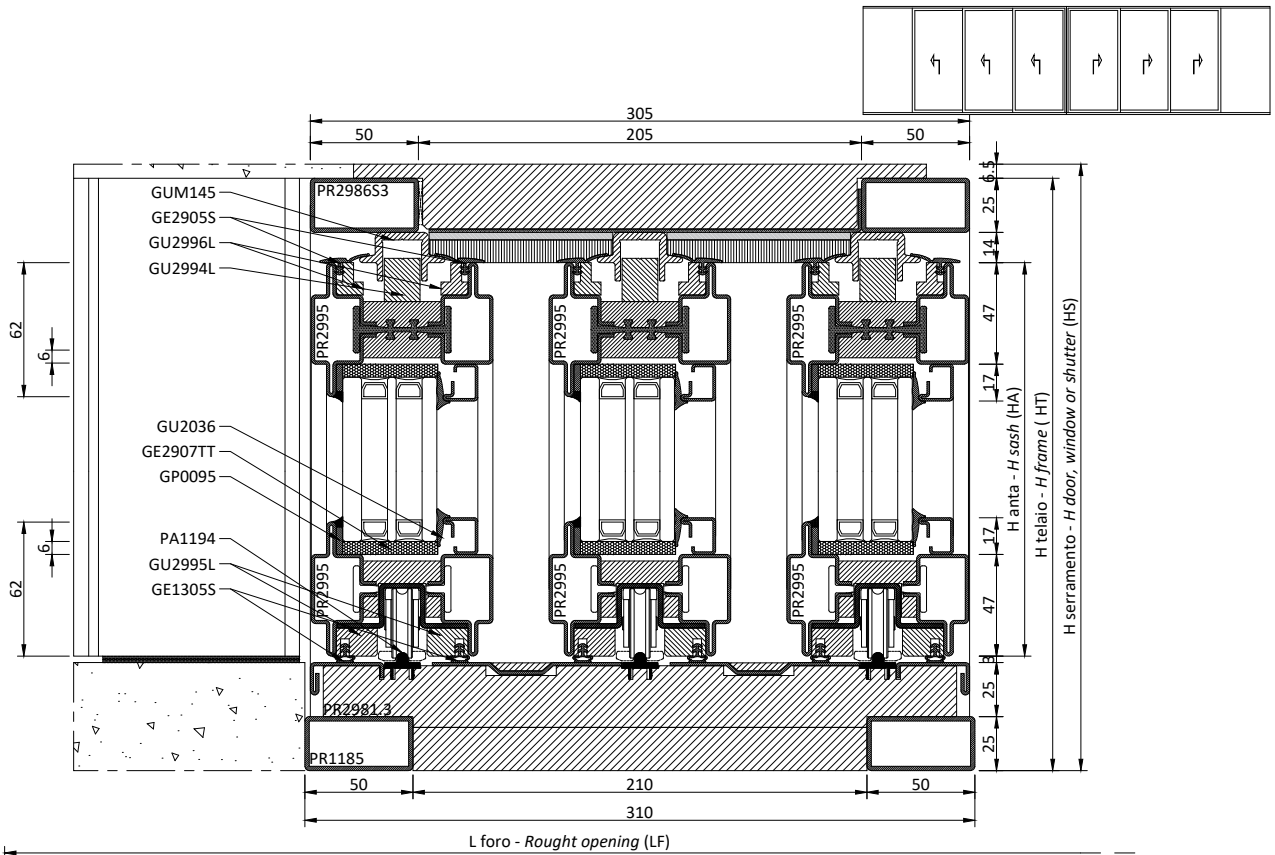

PROFILI		PROFILES			
Cod.	Descrizione	Description	n°	Dim.	Taglio/Cutting
<b>Telaio</b>		<b>Frame</b>			
PR298653	Profilo 50x25	Profile 50x25	2	4LF/3+107	90 90
	Profilo plastico	Plastic profile	1	4LF/3+107	90 90
	Profilo centrale a "L"	"L" profile	2	LF/3+61	90 90
	Profilo centrale a "C"	"C" profile	4	LF/6-22	90 90
	Profilo centrale a "L"	"L" profile	1	LF/3+18	90 90
PR1185	Tubo in acciaio 50x25 mm	50x25 mm steel tube	2	4LF/3+107	90 90
	Profilo plastico	Plastic profile	1	4LF/3+107	90 90
PR2981.3	Telaio base - copertina esterna (Part. A)	Lower frame - external cover (Detail A)	2	LF/6-53	90 90
	Telaio base - copertina interna (Part. A)	Lower frame - internal cover (Detail A)	1	LF+38	90 90
	Telaio base - copertina centrale (Part. B)	Lower frame - central cover (Detail B)	2	LF/6	90 90
	Telaio base - copertina centrale (Part. B)	Lower frame - central cover (Detail B)	2	LF/3-22	90 90
	Telaio base - copertina esterna (Part. C)	Lower frame - external cover (Detail C)	2	LF/6-21	90 90
	Telaio base - copertina esterna (Part. E)	Lower frame - external cover (Detail E)	1	LF/3+24	90 90
	Telaio base - profilo poliammide di supporto guide	Lower frame - polyamide profile of rails	1	4LF/3+107	90 90
<b>Guide</b>		<b>Rail</b>			
GUM145	Profilo guida superiore anta mobile	Upper rail of sliding sash	1	4LF/3+107	90 90
GUM145	Profilo guida superiore anta mobile	Upper rail of sliding sash	2	LF/2+69	90 90
GUM145	Profilo guida superiore anta mobile	Upper rail of sliding sash	2	LF/3+90	90 90
PA1194	Profilo guida inferiore	Lower profile	1	4LF/3+107	90 90
PA1194	Profilo guida inferiore	Lower profile	2	LF/2+42	90 90
PA1194	Profilo guida inferiore	Lower profile	2	LF/3+63	90 90
<b>Anta</b>		<b>Sash</b>			
PR2995	Profilo zoccolo	Bottom rail profile	12	LF/6+41	45 45
	Profilo zoccolo	Bottom rail profile	2	HT-92	45 45
	Profilo zoccolo	Bottom rail profile	2	HT-53	90 90
PR2992	Profilo a "T"	"T" profile	4	HT-92	45 45
PR2993	Profilo a "Z"	"Z" profile	6	HT-92	45 45
PR2947	Profilo labirinto centrale - anta mobile (Part. 1)	Central labyrinth profile - sliding sash (Detail 1)	6	HT-92	90 90
	Profilo labirinto centrale - anta mobile (Part. 2-3)	Central labyrinth profile - sliding sash (Detail 2)	6	HT-132	90 90
	Profilo labirinto centrale - anta fissa (Part. 1)	Central labyrinth profile - sliding sash (Detail 1)	2	HT-53	90 90
	Profilo labirinto centrale - anta fissa (Part. 2-3)	Central labyrinth profile - sliding sash (Detail 2)	2	HT-93	90 90
PR2947.3	Profilo labirinto centrale - anta mobile (Part. 1)	Central labyrinth profile - sliding sash (Detail 1)	4	HT-92	90 90
	Profilo labirinto centrale - anta mobile (Part. 2-3-4)	Central labyrinth profile - sliding sash (Detail 2)	4	HT-132	90 90
PR1180	Stampato di finitura	Cover profile	2	HT-92	90 90
GU2995L	Profilo plastico porta guarnizione perimetrale	Plastic profile for rebate gasket support	4	HT-92	45 45
	Profilo plastico porta guarnizione perimetrale	Plastic profile for rebate gasket support	2	LF/6+26	45 90
	Profilo plastico porta guarnizione perimetrale	Plastic profile for rebate gasket support	2	LF/6+26	90 45
	Profilo plastico porta guarnizione perimetrale	Plastic profile for rebate gasket support	8	LF/6+11	90 90
GU2996L	Profilo plastico porta guarnizione superiore	Plastic profile for rebate gasket support	2	LF/6+26	90 45
	Profilo plastico porta guarnizione superiore	Plastic profile for rebate gasket support	2	LF/6+26	45 90
GU2994L	Profilo plastico porta guarnizione superiore	Plastic profile for rebate gasket support	8	LF/6+11	90 90
	Pattino di scorrimento anta mobile e fissa	Runner for sliding and fixed sash	6	LF/6+36	90 90
<b>Fermavetri</b>		<b>Glazing beads</b>			
PR2606	Profilo fermavetro	Glazing bead profile	6	LF/6-53	45 45
	Profilo fermavetro	Glazing bead profile	6	HT-186	45 45
<b>Vetri</b>		<b>Glass unit</b>			
	Vetrocamera	Double glazing	2	(LF/6-65) × (HT-198)	
<b>ACCESSORI</b>		<b>HARDWARE</b>			
Cod.	Descrizione	Description	n°	Note/Notes	
AG2992L.EF	Rostro aggiuntivo	Additional hook bolt	opz.		
AG2996T3.xx	Kit alzante scorrevole	Lift and slide kit	1		
ACV__	Maniglione	Large handle	6		
AC2995.1	Kit squadrette di giunzione ante	Corner joint kit Sashes	2		
AC2995.2	Kit squadrette di giunzione ante	Corner joint kit Sashes	4		
AG2989L.EF	Prolunga superiore cremonese	Upper cremonese extension	6	> 2908	
AG2989C	Profilo di copertura aggiuntivo	Additional covering profile	6	> 2908	
AC1305G	Angolo vulcanizzato per GE1305S	Vulcanised corner gasket for GE1305S	2		
AC2608AR	Clips fissaggio fermavetri	Clips for glazing bead	var.		
<b>GUARNIZIONI*</b>		<b>GASKETS*</b>			
Cod.	Descrizione	Description	n°	Dim.	
GU2036	Piattina adesiva morbida esterno vetro	Soft adhesive shim for external window	1	2xLF+12xHT	
GU2907TT	Guarnizione sotto vetro	Under glass gasket	1	2xLF+12xHT	
GP0095	Guarnizione interna vetro	Internal glass gasket	1	2xLF+12xHT	
GE2905S	Guarnizione superiore ante	Gasket for upper sash	1	2xLF	
GE1305S	Guarnizione perimetrale ante	Gasket for side sash	1	2xLF+2xHT	
GE1142	Guarnizione labirinto centrale	Gasket for central labyrinth	1	12xHT	
GU1387	Spazzolino verticale labirinto	Vertical labyrinth brush + adhesive	1	12xHT	
* le dimensioni delle guarnizioni sono indicative e devono essere aumentate del 10% per adattamenti e ritiri del materiale nel tempo					
* the gasket dimensions are indicative and have to be increased by 10% owing to adaptation and contractions of the material over time					

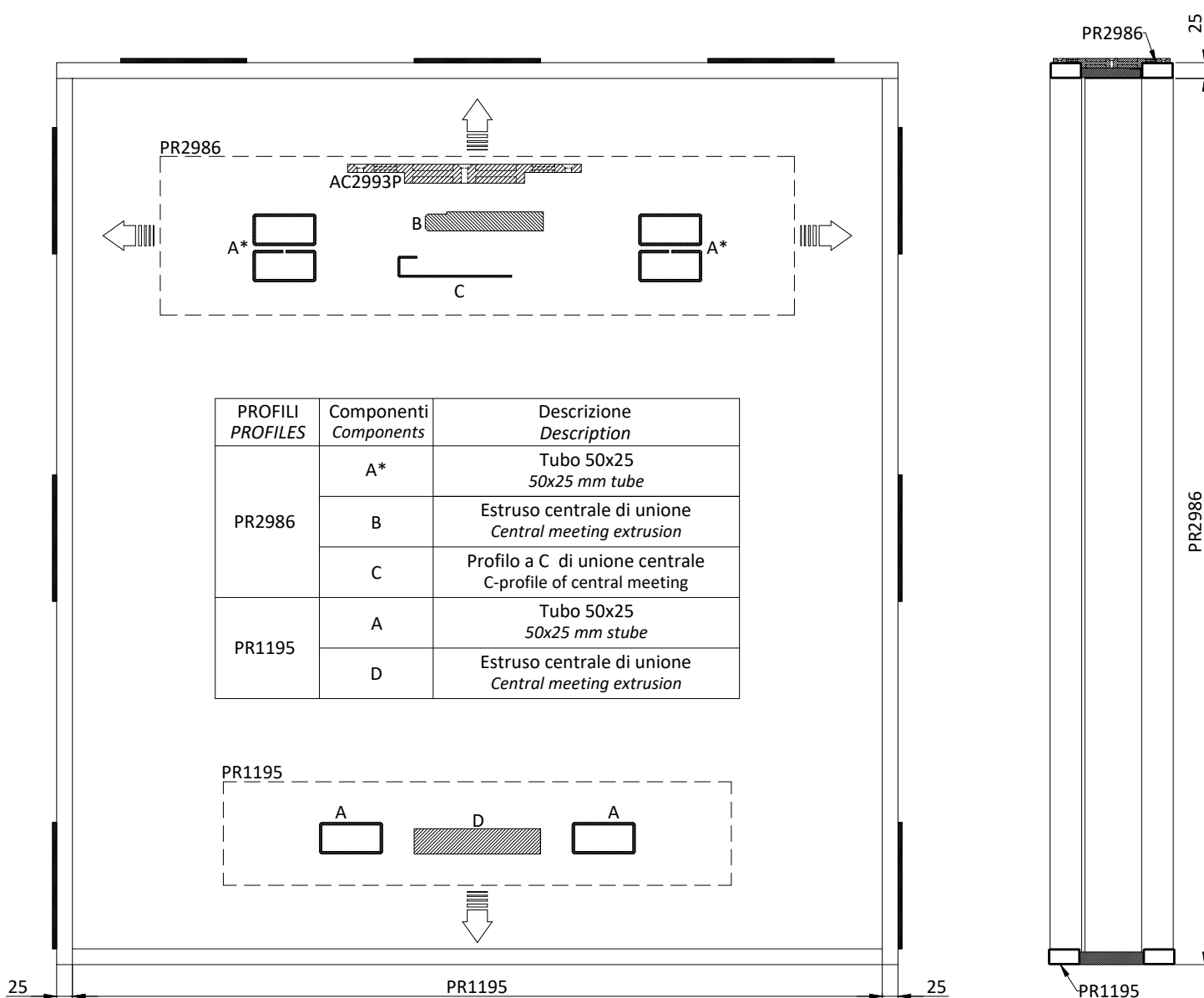
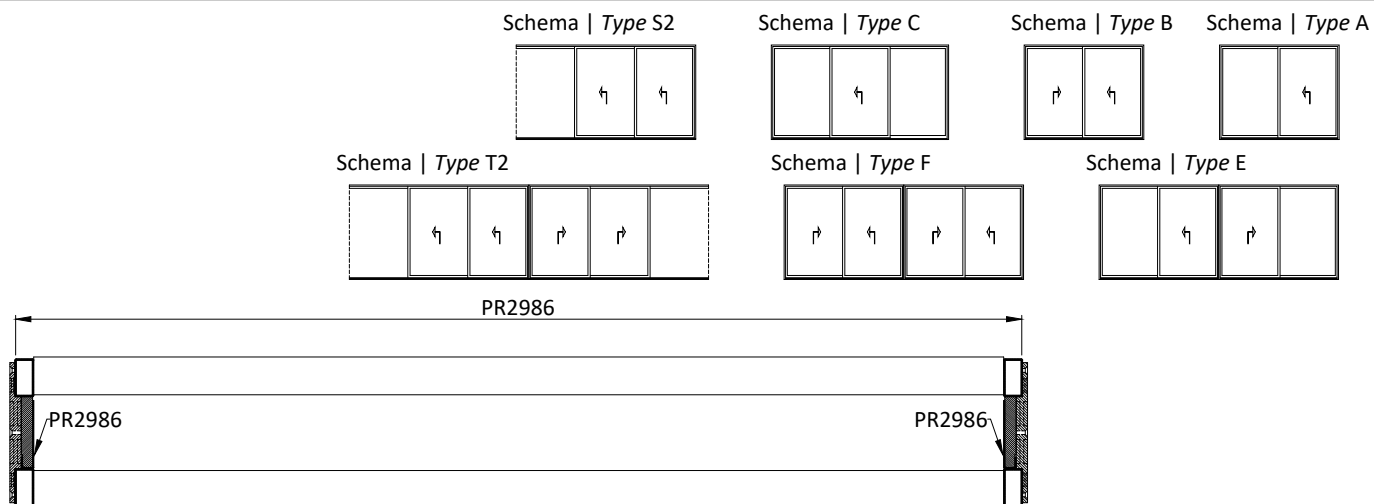

\* ATTENZIONE forare il profilo prima dell'assemblaggio per il fissaggio della guida GUM145  
\* ATTENTION perforate the profile before assembling to attach the GUM145 rail

Schema | Type S3

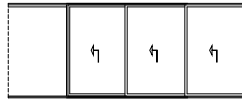

Schema | Type C3



Schema | Type B3

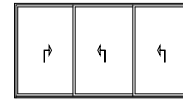

Schema | Type A3



Schema | Type T3

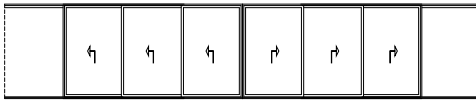

Schema | Type F3

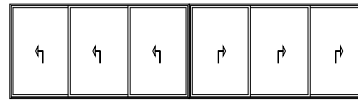

Schema | Type E3

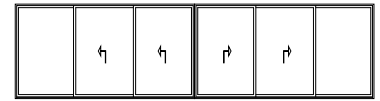

PR2986.3-PR2986S3

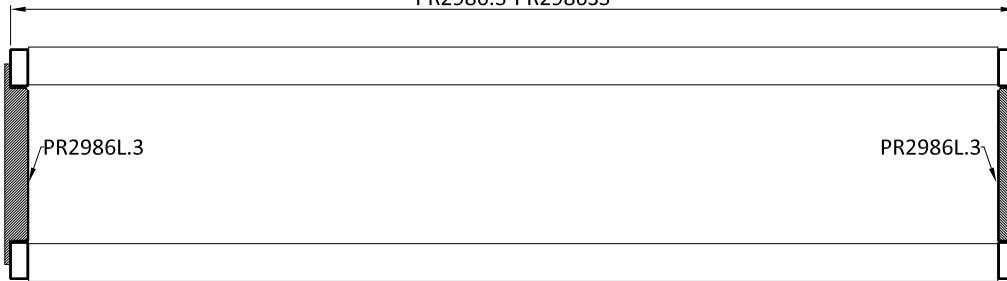

PR2986.3-PR2986S3 superiore | upper  
PR2986L.3 laterale | lateral

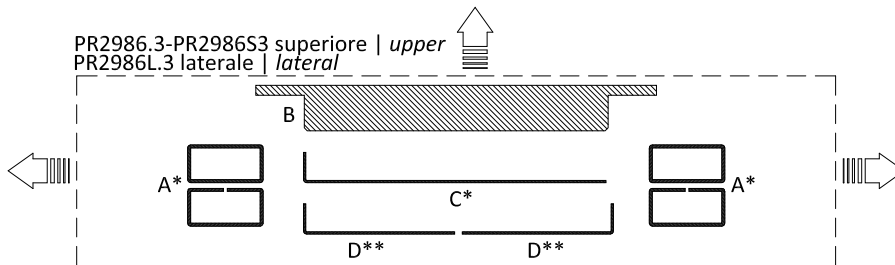

PROFILI PROFILES	Componenti Components	Descrizione Description
PR2986.3 PR2986L.3**	A*	Tubo 50x25 50x25 mm tube
	B	Estruso centrale di unione Central meeting extrusion
	C*	Profilo a L di unione centrale L-profile of central meeting
	D**	Profilo a L di unione centrale L-profile of central meeting
PR1185	A	Tubo 50x25 50x25 mm tube
	E	Estruso centrale di unione Central meeting extrusion

PR1185

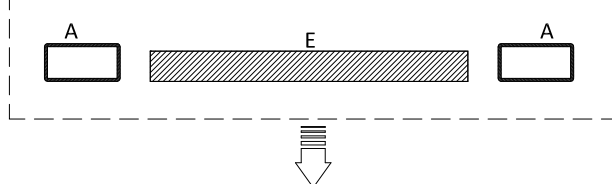

25

PR1185

25

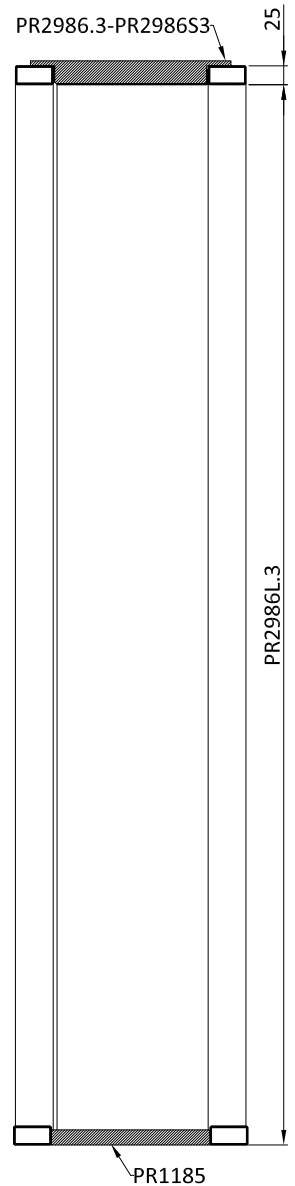

\* ATTENZIONE forare il profilo prima dell'assiemeaggio per il fissaggio della guida GUM145  
\* ATTENTION perforate the profile before assembling to attach the GUM145 rail  
\*\* ATTENZIONE PR2986L.3 non contiene lamiera "D"  
\*\* ATTENTION PR2986L.3 do not included metal sheet "D"

Schema | Type T1

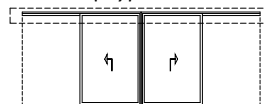

Schema | Type S1

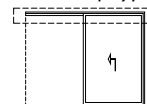

Prima di assemblare il telaio esterno forare  $\varnothing 4$  mm il profilo superiore per fissaggio guida GUM145  
*Before assembling the frame make a  $\varnothing 4$  mm hole in the upper profile to attach the GUM145 rail*

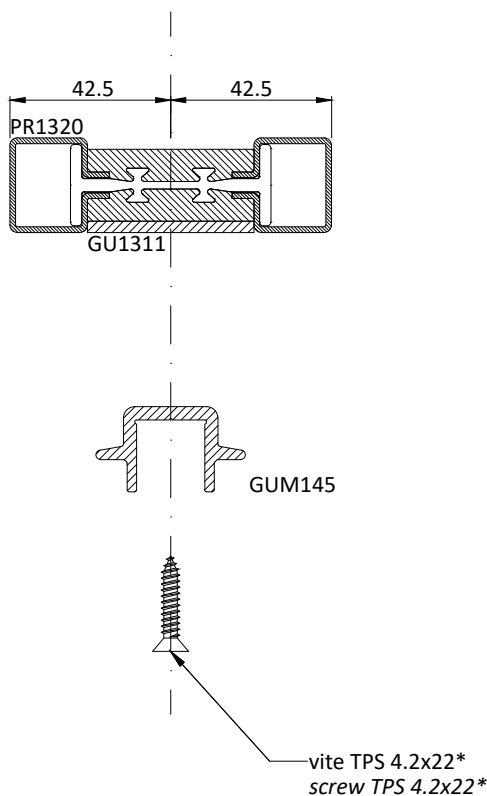

Il passo di foratura viene definito nelle singole schede di applicazione guida GUM145 delle specifiche tipologie realizzabili  
*The spacing of the drilled holes is described in the individual rail GUM145 application sheets for the specific typologies possible*

\* viti TPS 4.2x22 non comprese  
 \* screws TPS 4.2x22 not supplied

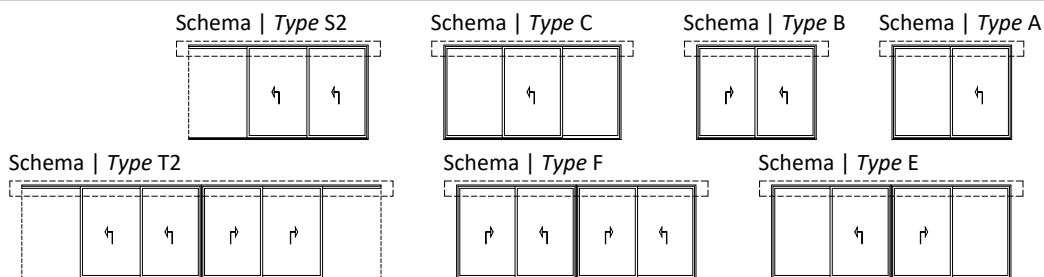

Prima di assemblare il telaio esterno forare  $\varnothing 4$  mm il profilo superiore per fissaggio guida GUM145  
 Before assembling the frame make a  $\varnothing 4$  mm hole in the upper profile to attach the GUM145 rail

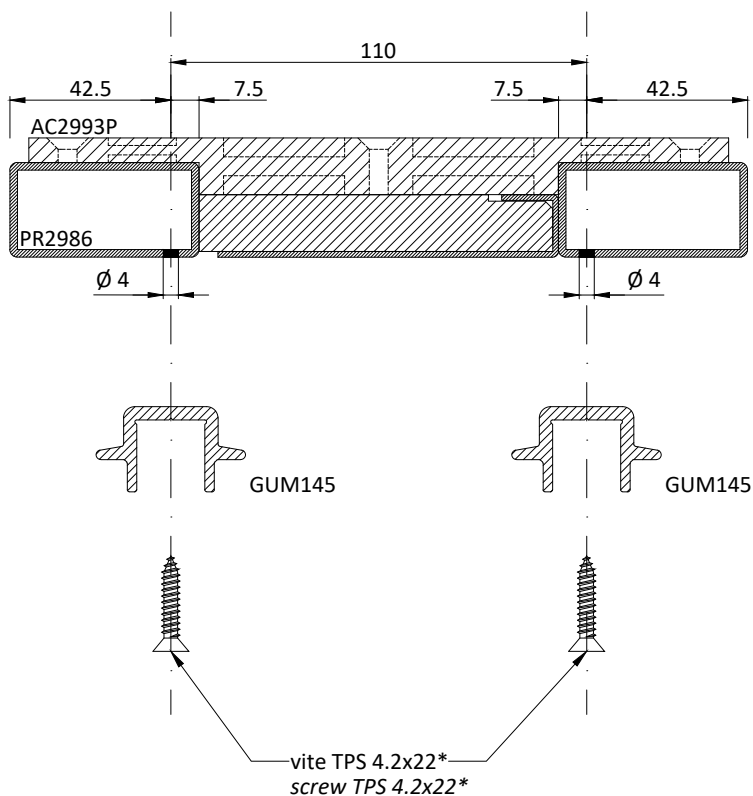

Il passo di foratura viene definito nelle singole schede di applicazione guida GUM145 delle specifiche tipologie realizzabili  
 The spacing of the drilled holes is described in the individual rail GUM145 application sheets for the specific typologies possible

\* viti TPS 4.2x22 non comprese  
 \* screws TPS 4.2x22 not supplied

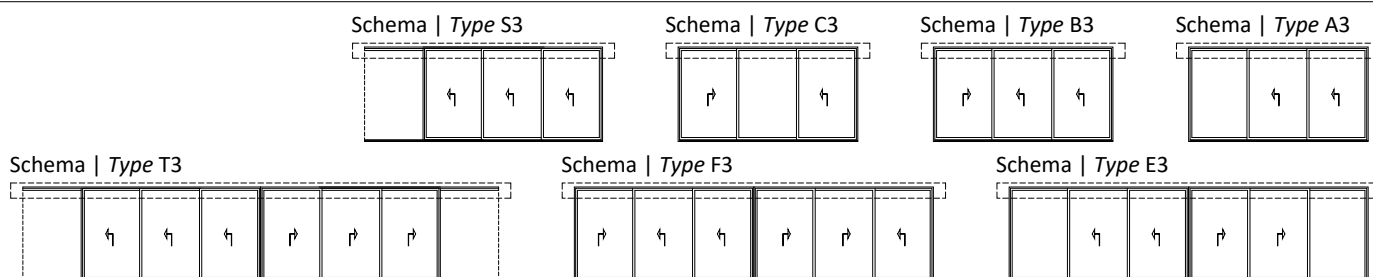

Prima di assemblare il telaio esterno forare  $\varnothing 4$  mm il profilo superiore per fissaggio guida GUM145  
 Before assembling the frame make a  $\varnothing 4$  mm hole in the upper profile to attach the GUM145 rail

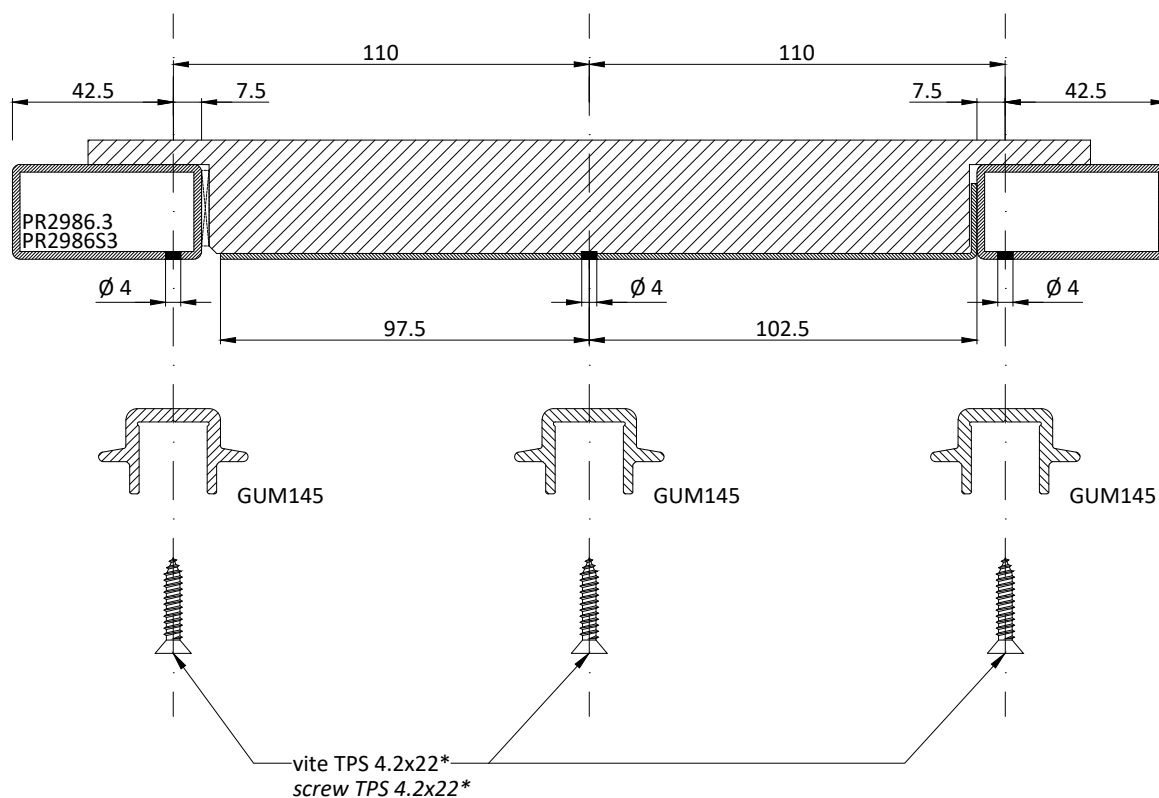

Il passo di foratura viene definito nelle singole schede di applicazione guida GUM145 delle specifiche tipologie realizzabili  
 The spacing of the drilled holes is described in the individual rail GUM145 application sheets for the specific typologies possible

\* viti TPS 4.2x22 non comprese  
 \* screws TPS 4.2x22 not supplied

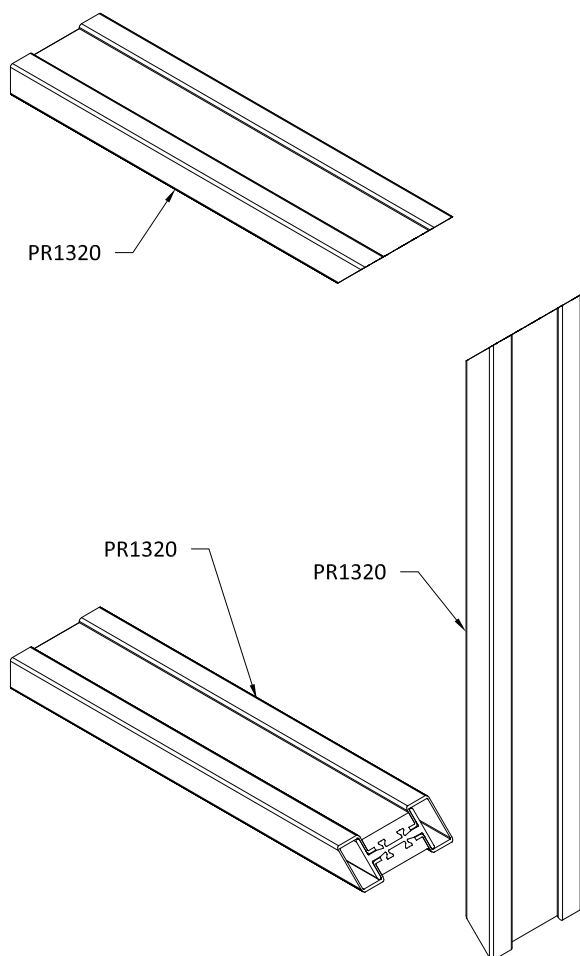
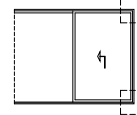
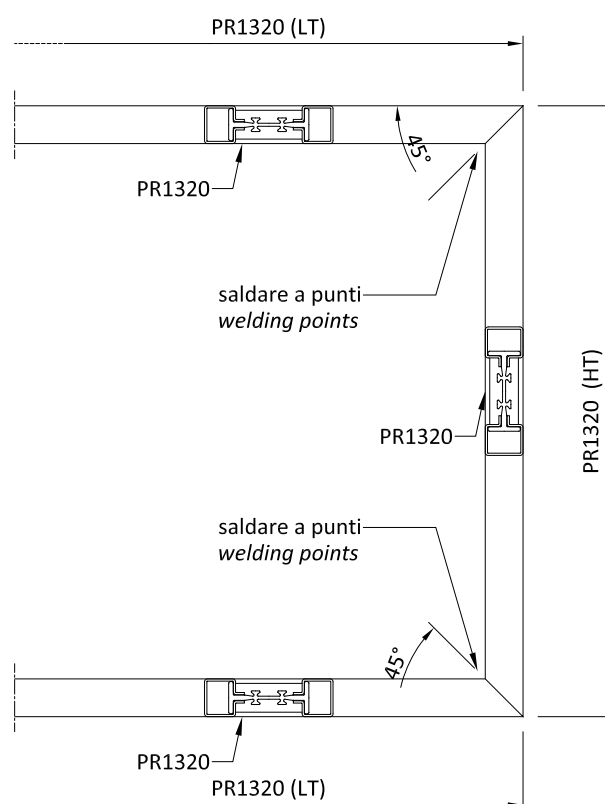

Schema | Type S1

PR1320  
Procedura di assemblaggio telaio | *Frame assembly procedure:*

- saldare a punti dove indicato; ove non indicato, saldare in continuo  
*welding points where indicated; where not indicated, continuous welding*
- sigillare internamente ed esternamente  
*seal off inside and outside*

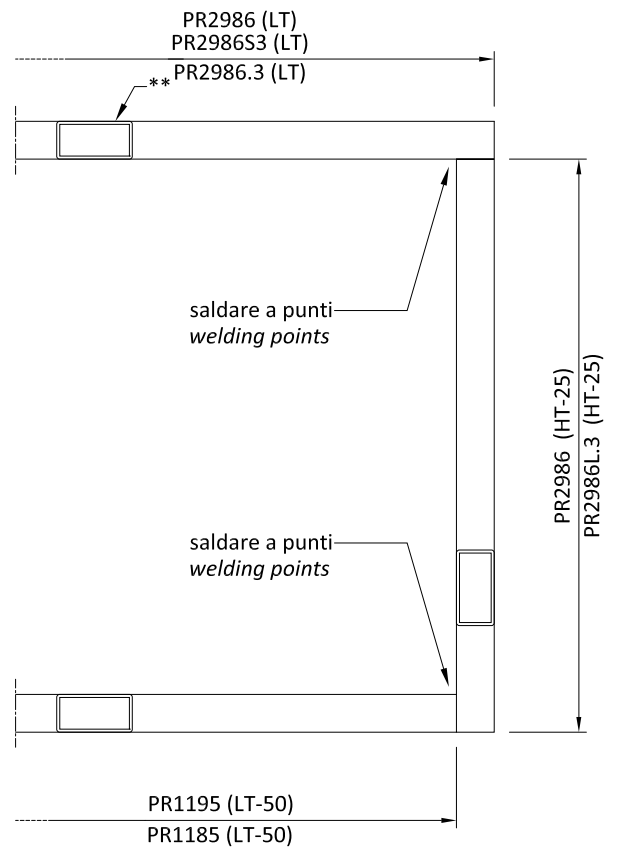
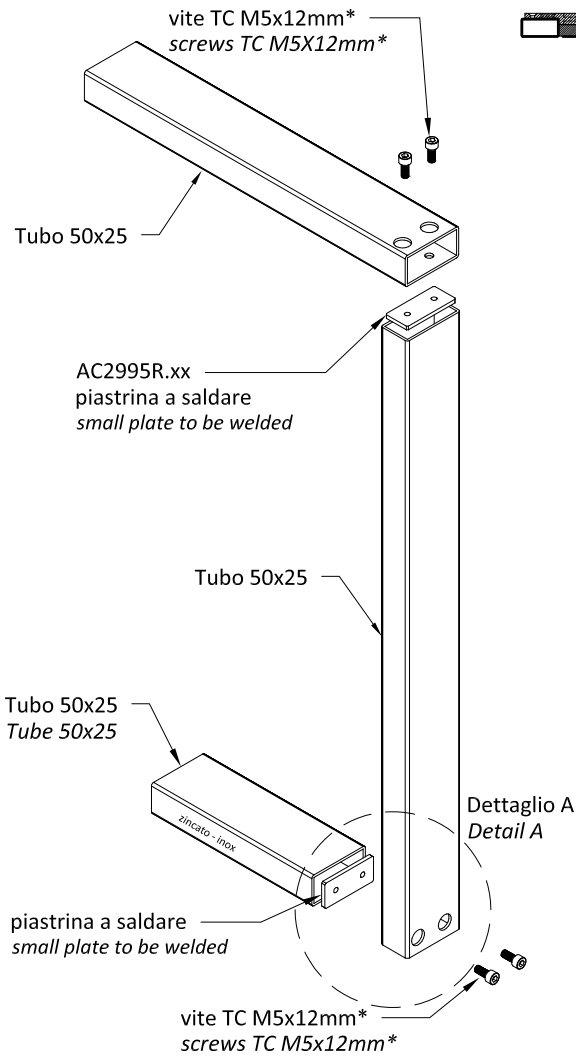
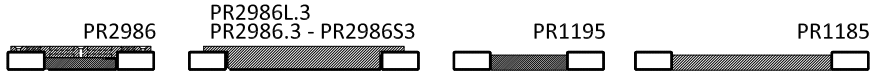
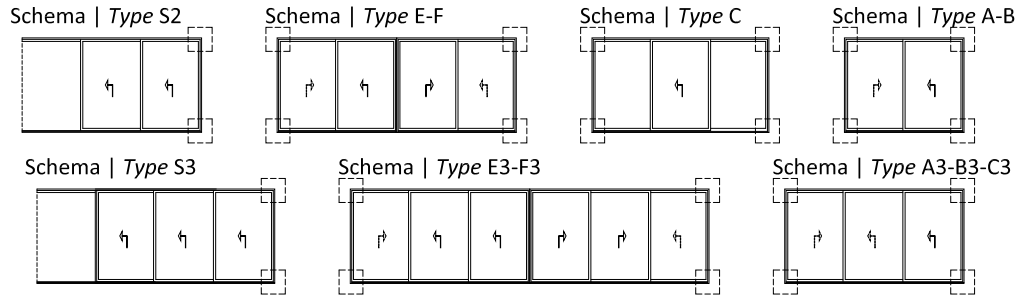

Dettaglio | Detail A

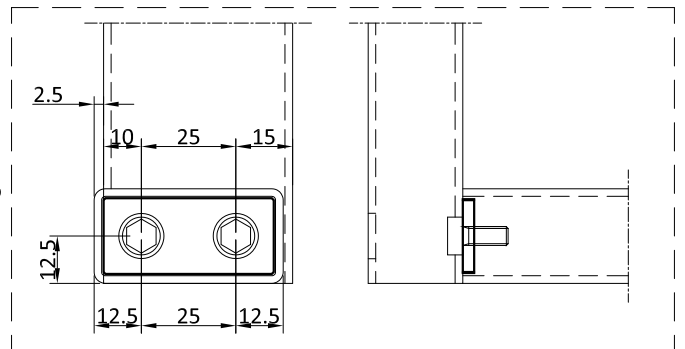

Procedura di assemblaggio telaio | Frame assembly procedure:

- a. saldare le piastrine  
*weld the plates*
- b. intestare il montante verticale ed orizzontale con viti M5x12  
*end the vertical and horizontal upright fixed with M5x12 screws*
- c. saldare a punti dove indicato; ove non indicato, saldare in continuo  
*welding points where indicated; where not indicated, continuous welding*
- d. sigillare internamente ed esternamente  
*seal off inside and outside*

\* viti TC M5x12 non comprese | screws TC M5x12 not included

\*\*ATTENZIONE forare il profilo prima dell'assemblaggio per il fissaggio della guida GUM145

\*\*ATTENTION perforate the profile before assembling to attach the GUM145 rail



Schema | Type B

Schema | Type A

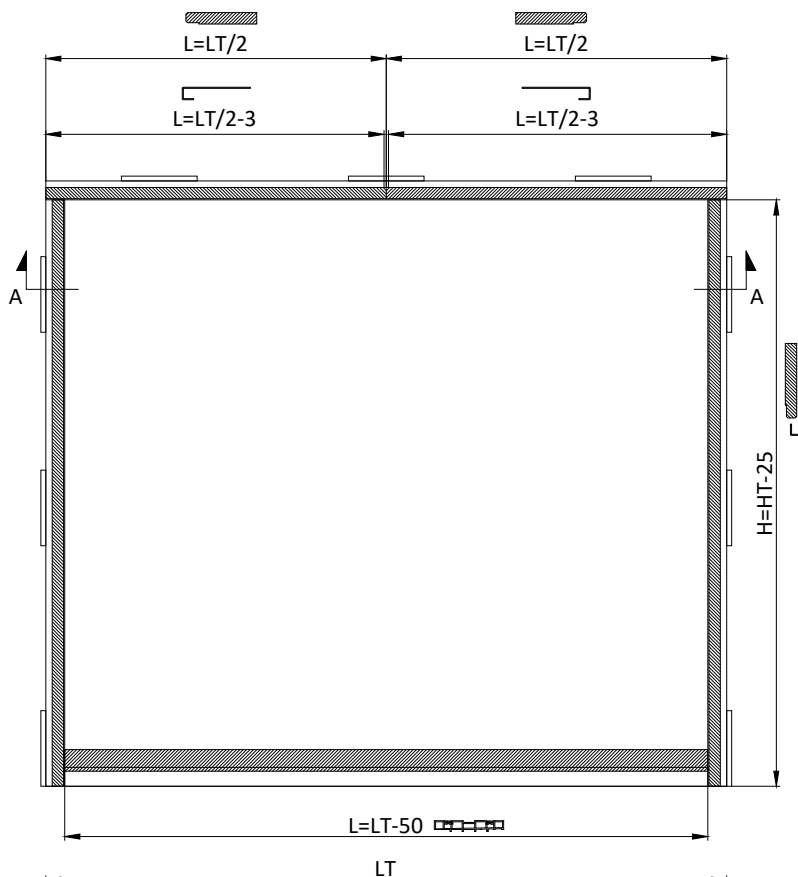
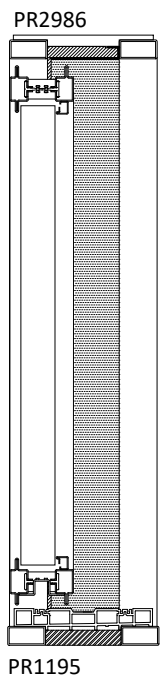
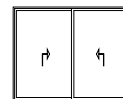

Sezione A-A  
 Section A-A

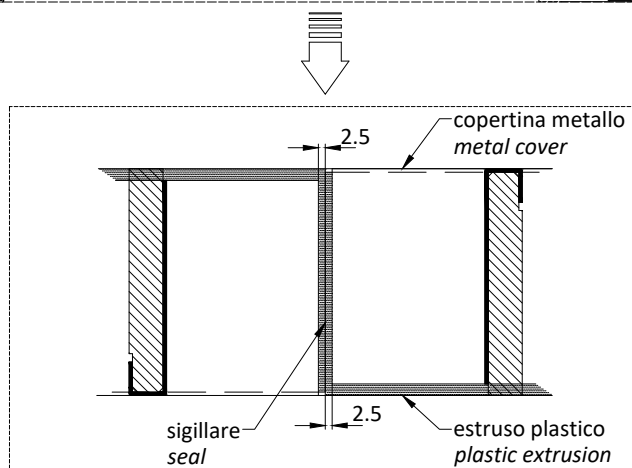
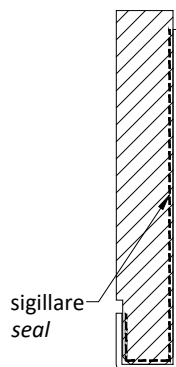
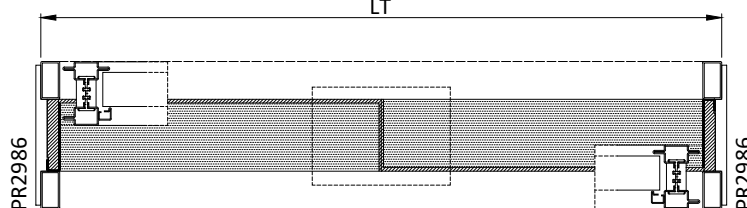

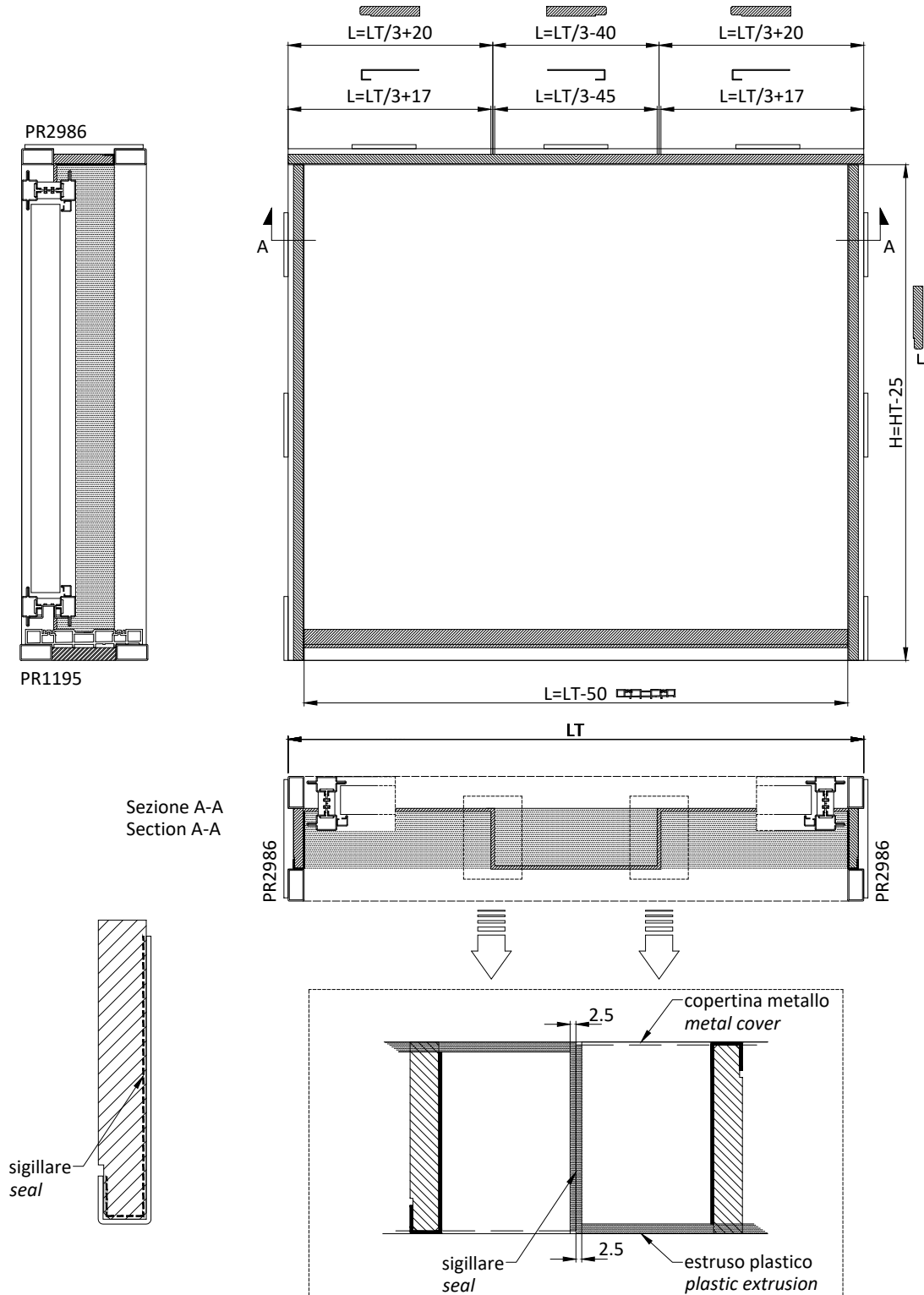
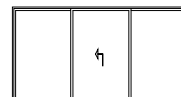

Schema | Type F

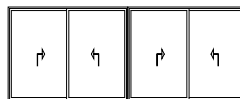

Schema | Type E

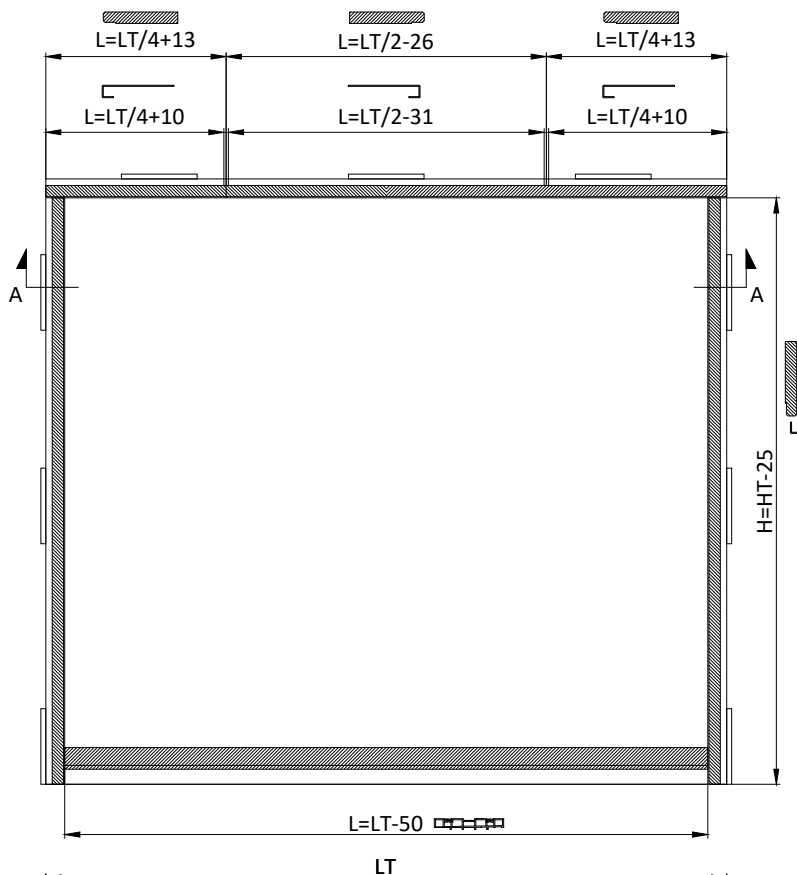
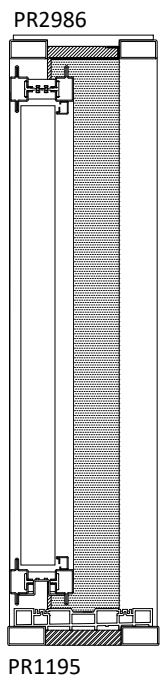
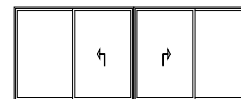

Sezione A-A  
 Section A-A

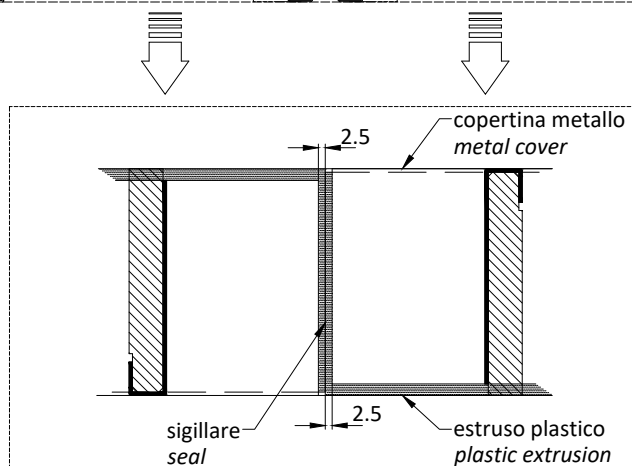
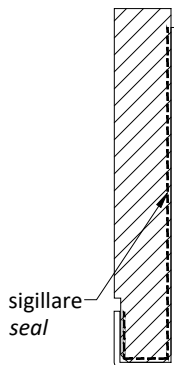
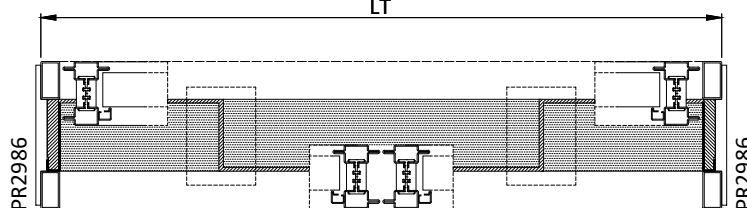

Schema | Type C3

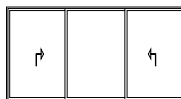

Schema | Type B3

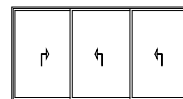

Schema | Type A3

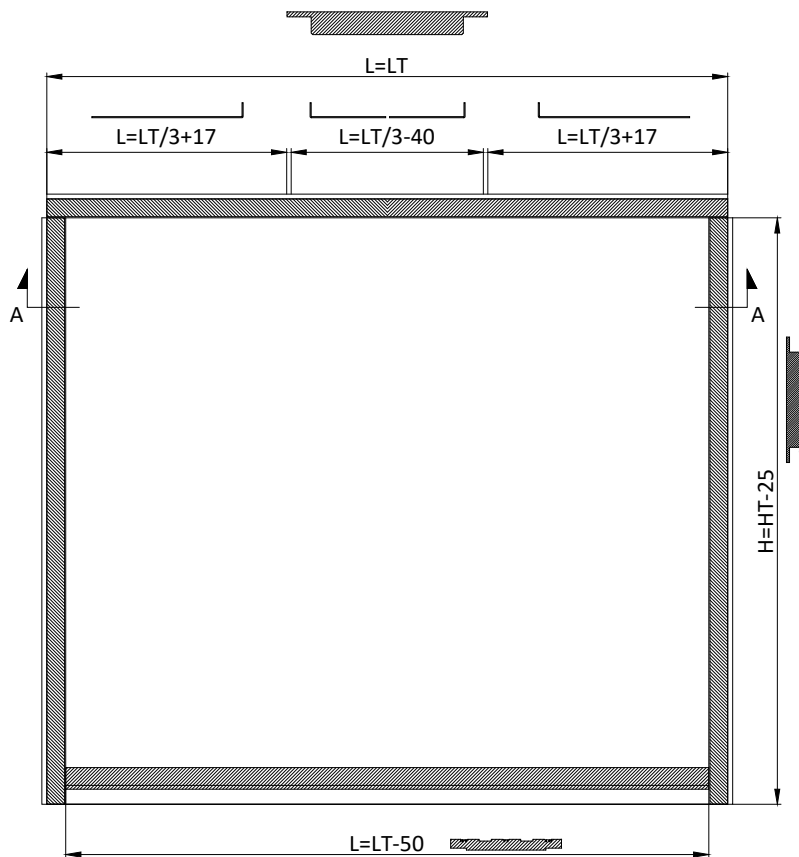
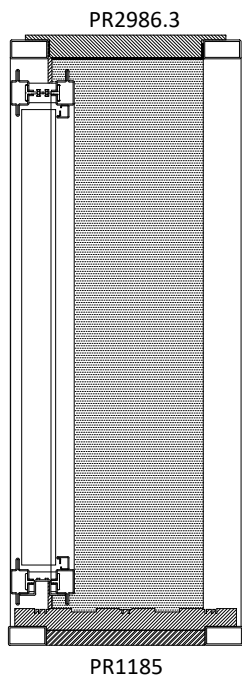
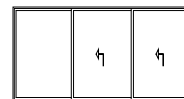

Sezione A-A  
 Section A-A

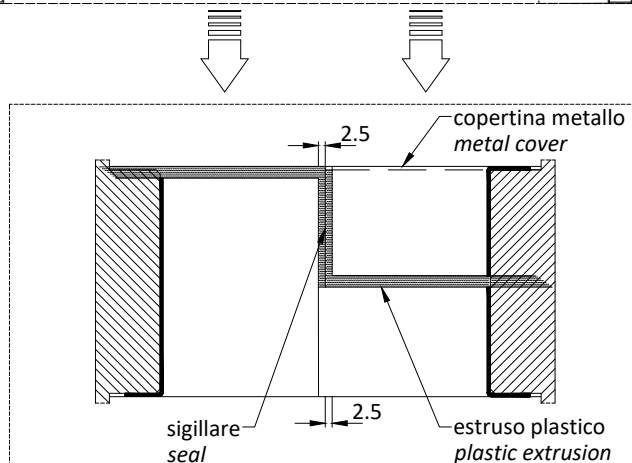
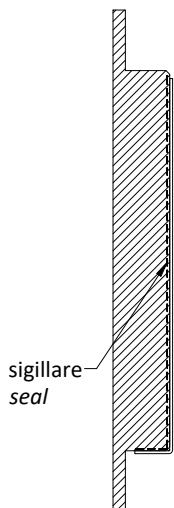
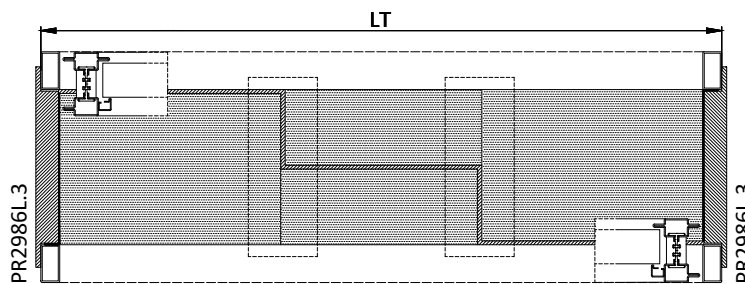

Schema | Type F3

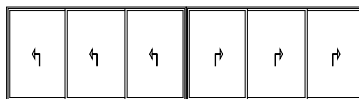

Schema | Type E3

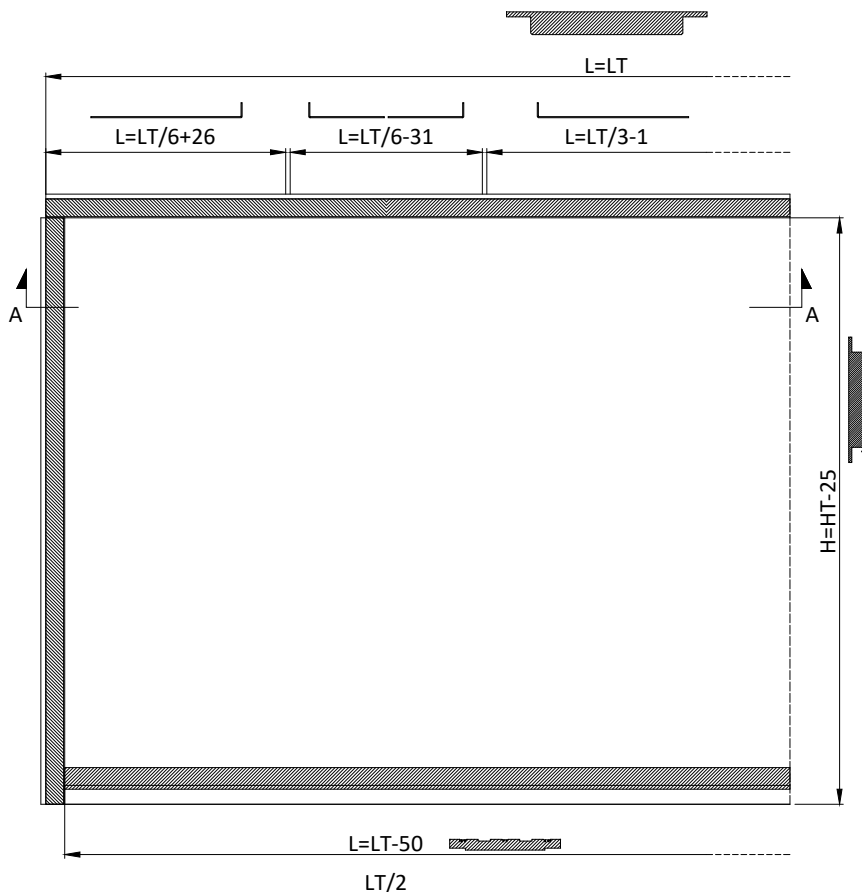
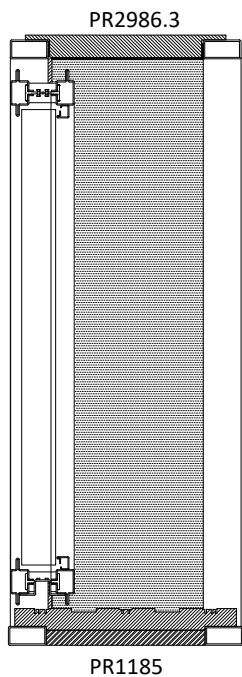
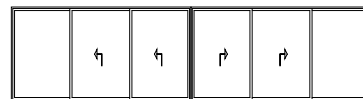

Sezione A-A  
 Section A-A

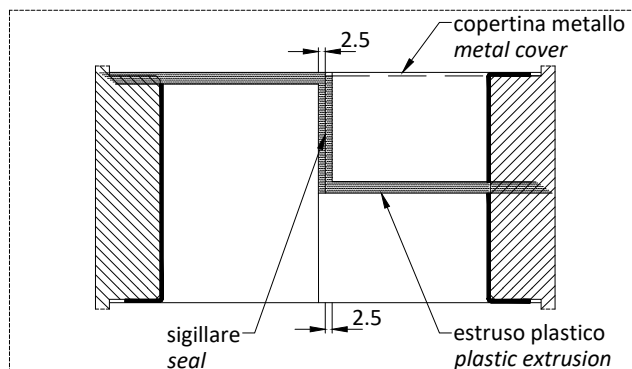
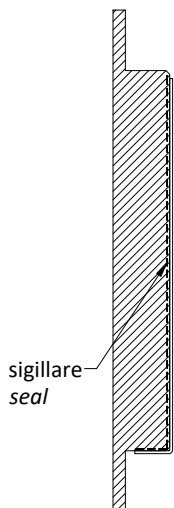
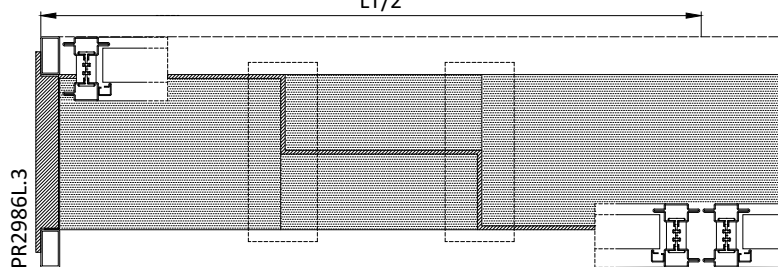

Schema | Type S2

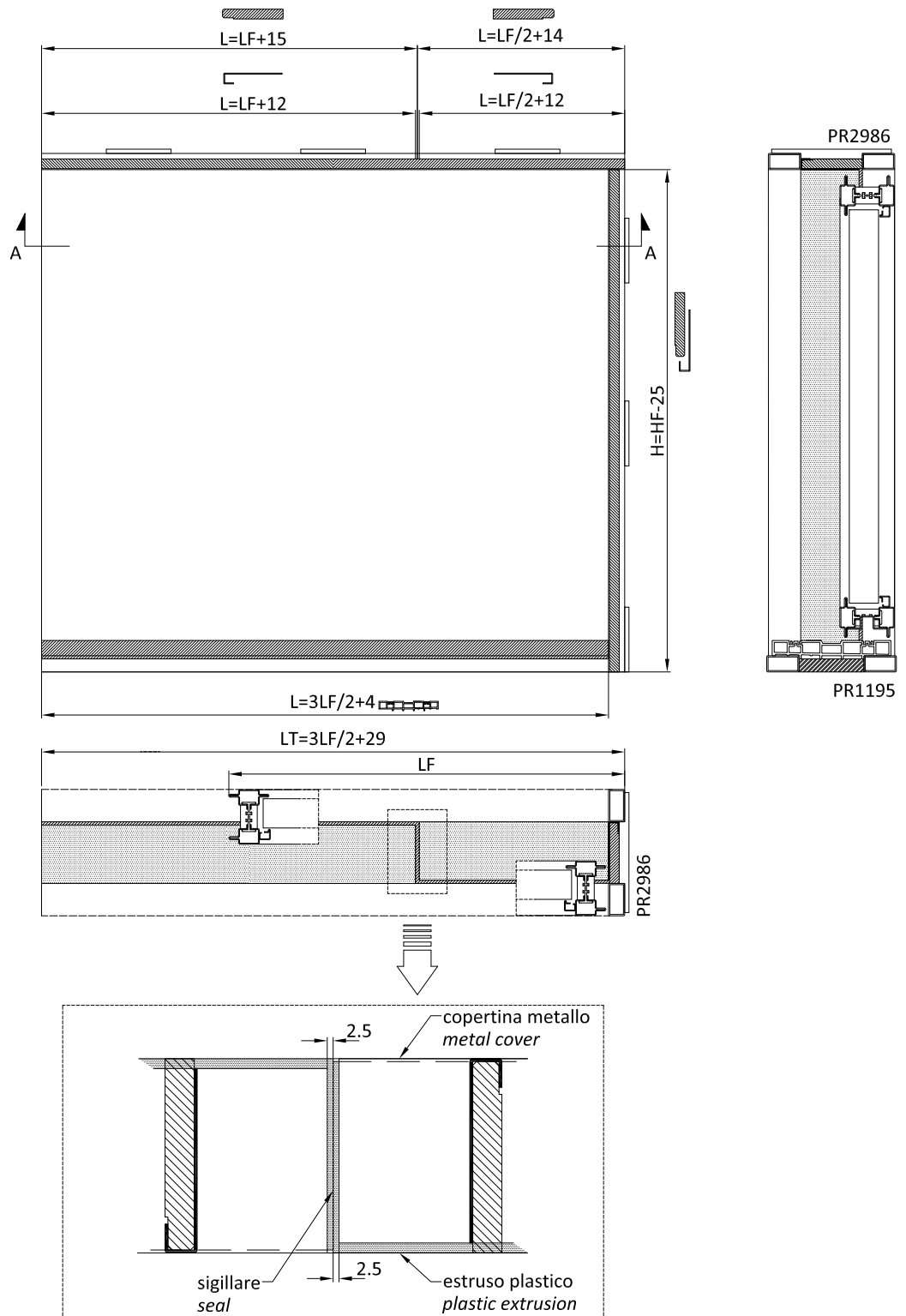



Schema | Type T2

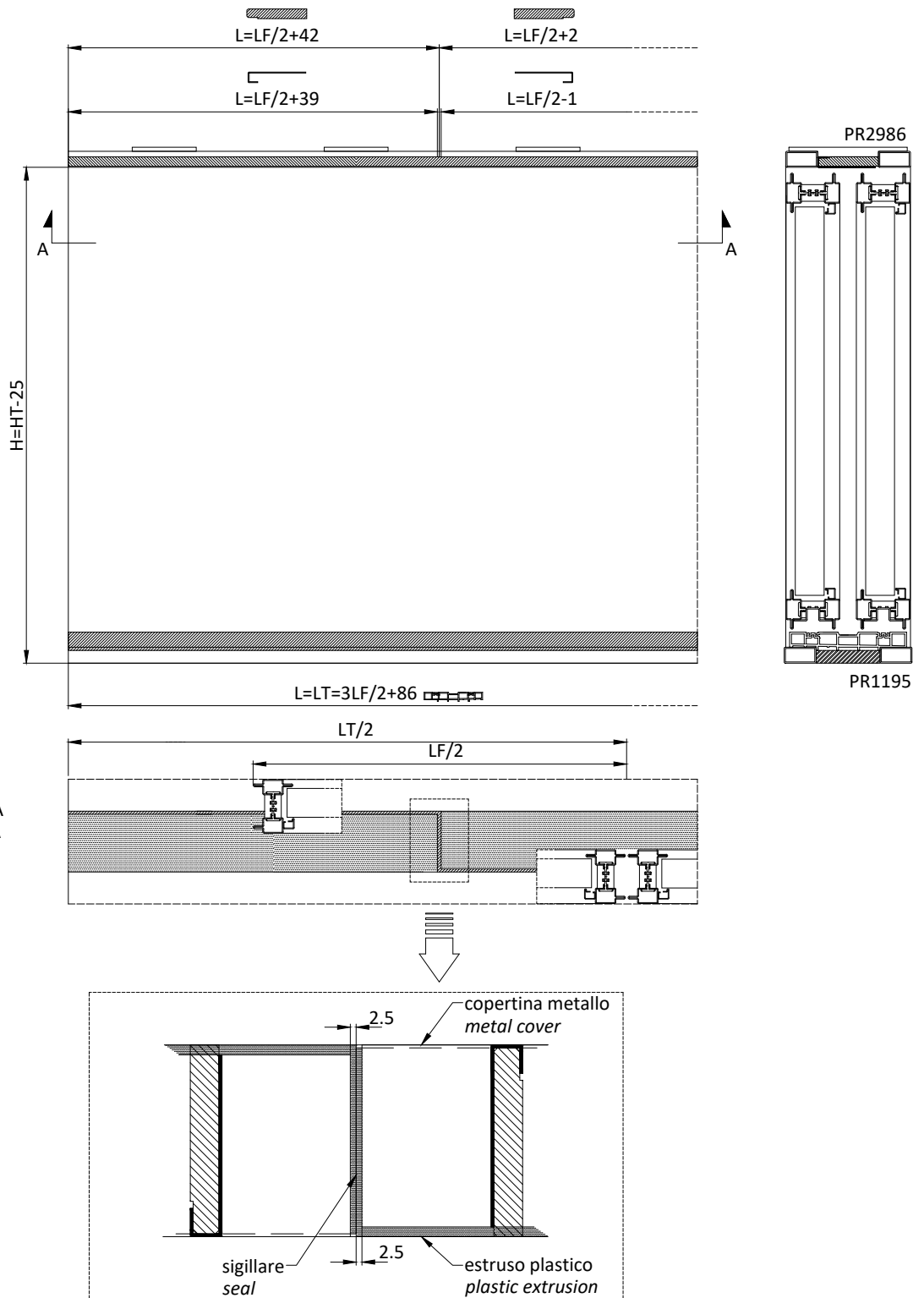
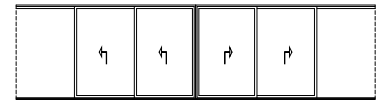

Schema | Type S3

	4	4	4
--	---	---	---

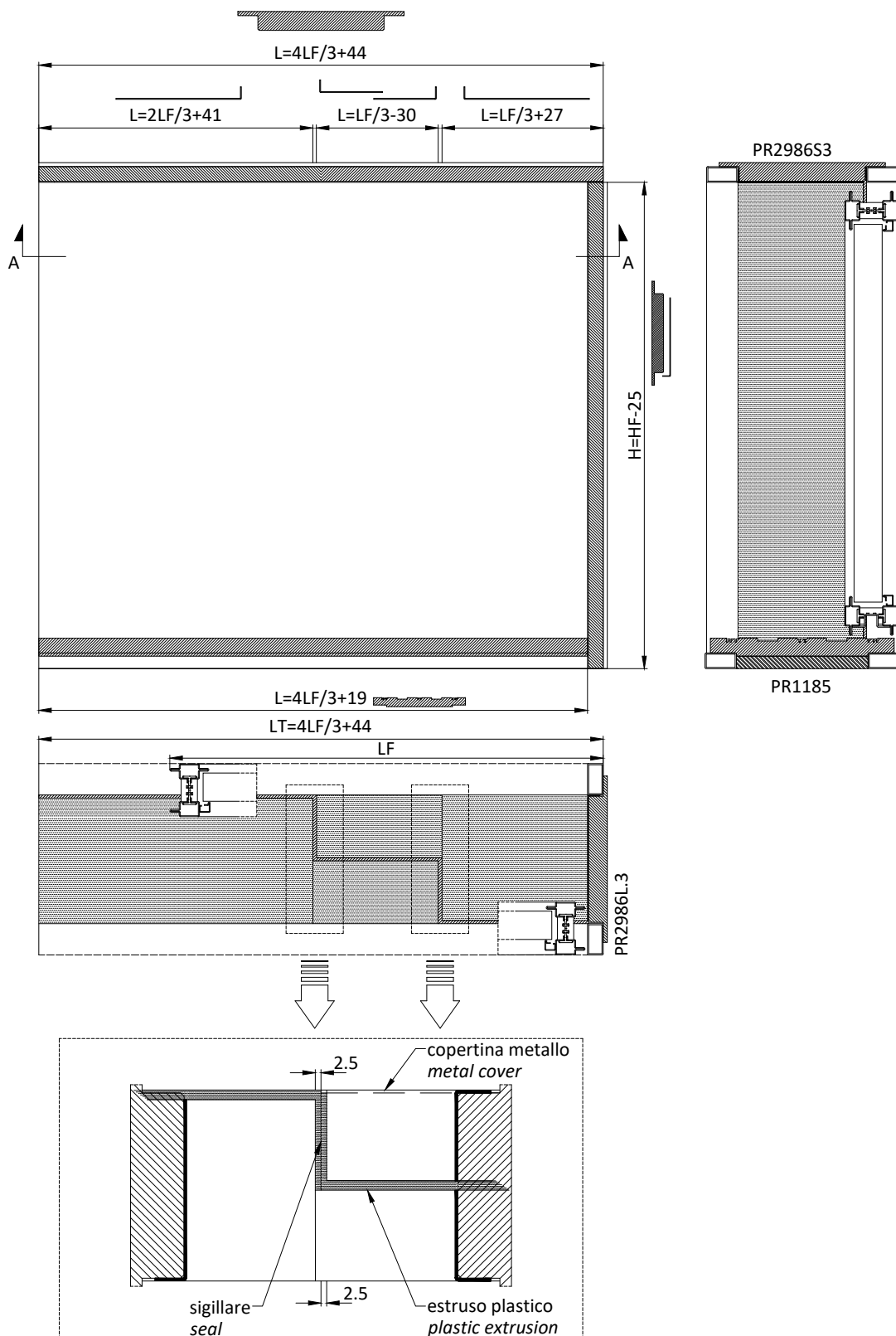

Schema | Type T3

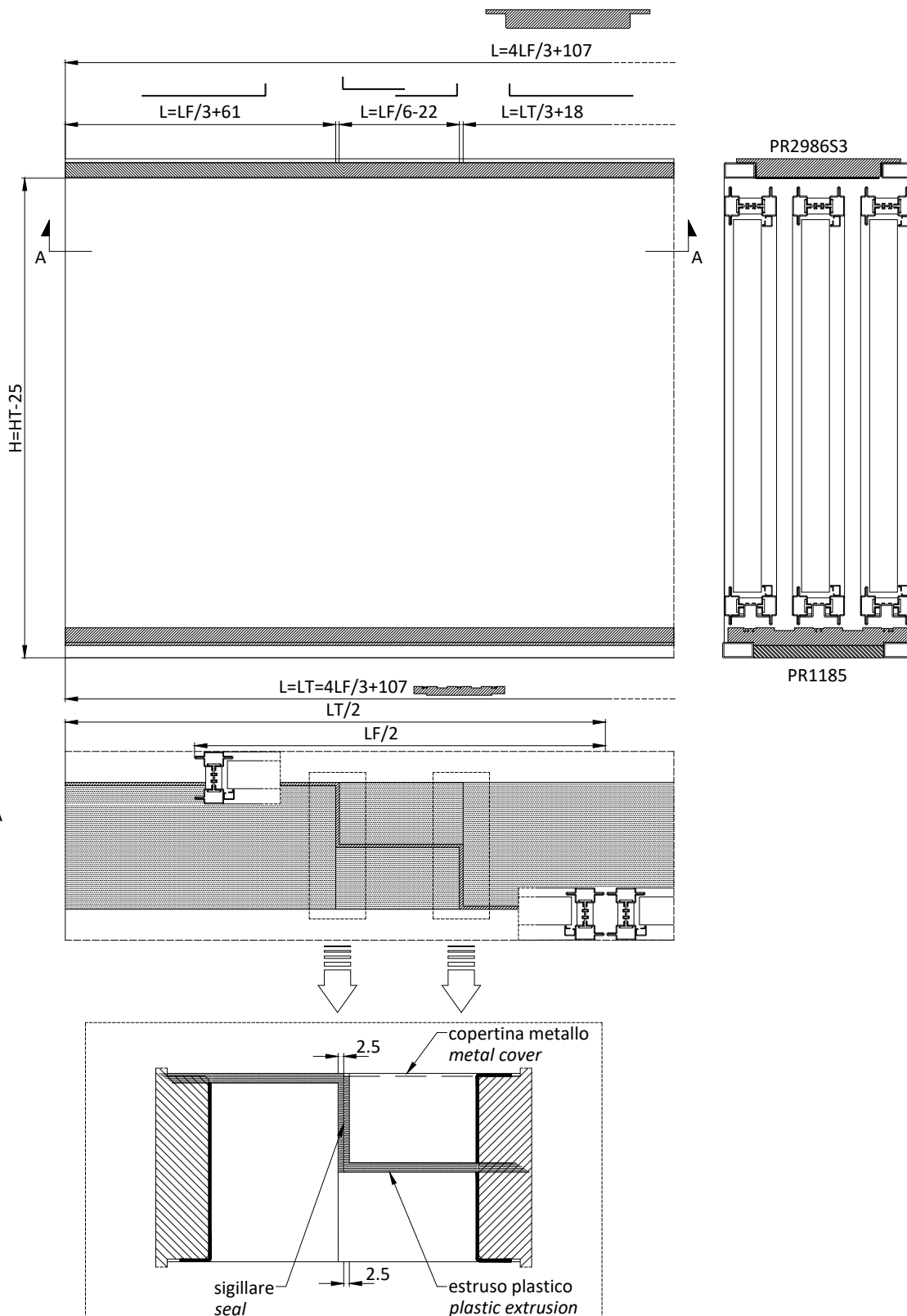
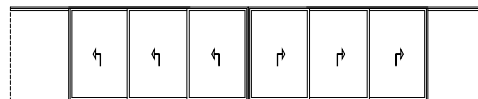

Schema | Type B      Schema | Type A

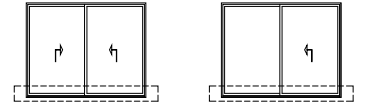

Fresata per tamponi  
Milled for pad

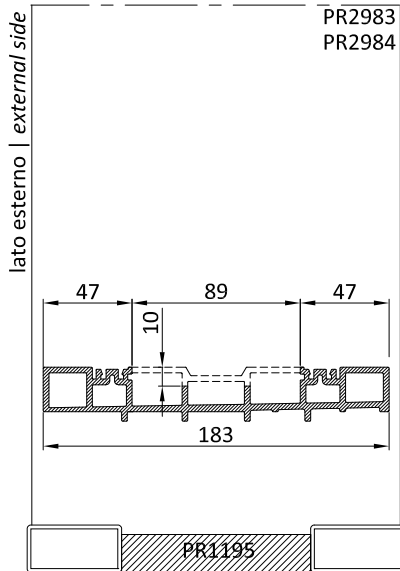

Fresate per scarico acqua  
Milled for water drip

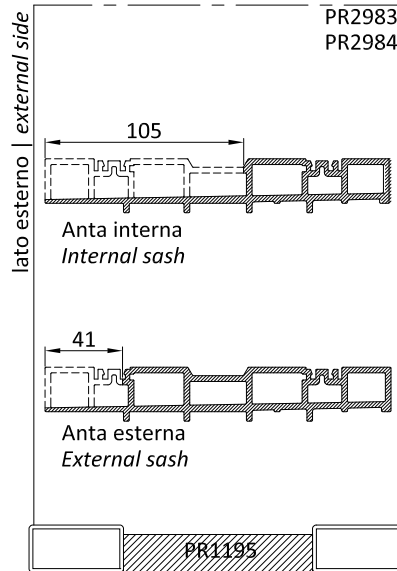

Fori di fissaggio  
Anchoring holes

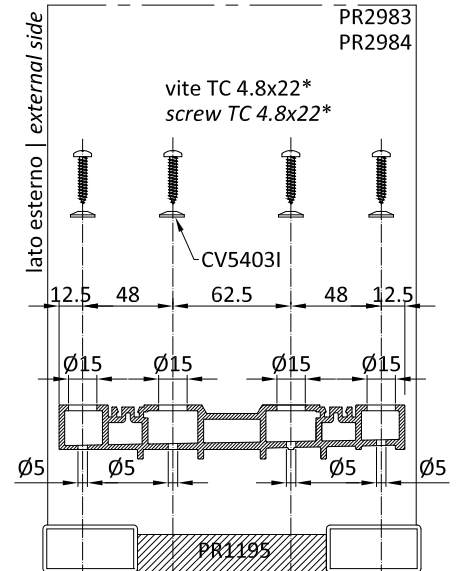

Fresate per scarico acqua e tamponi  
Milled for water drip and pads

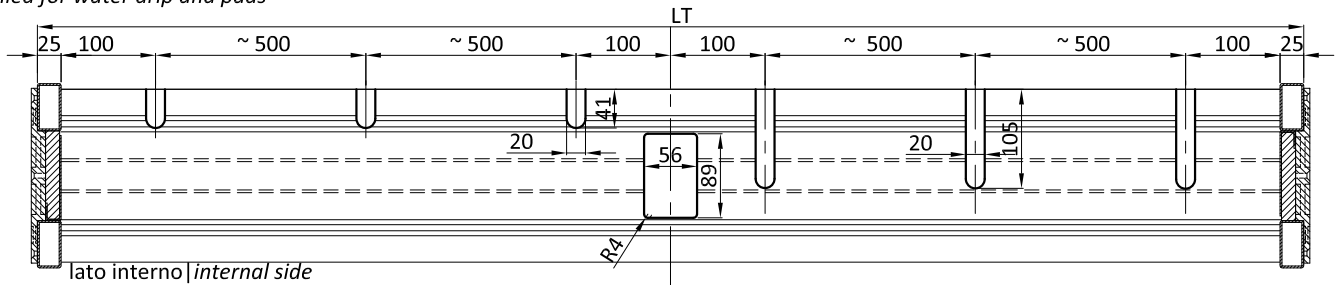

Foro Ø15 per viti 4.8x22  
Hole Ø15 for screws 4.8x22

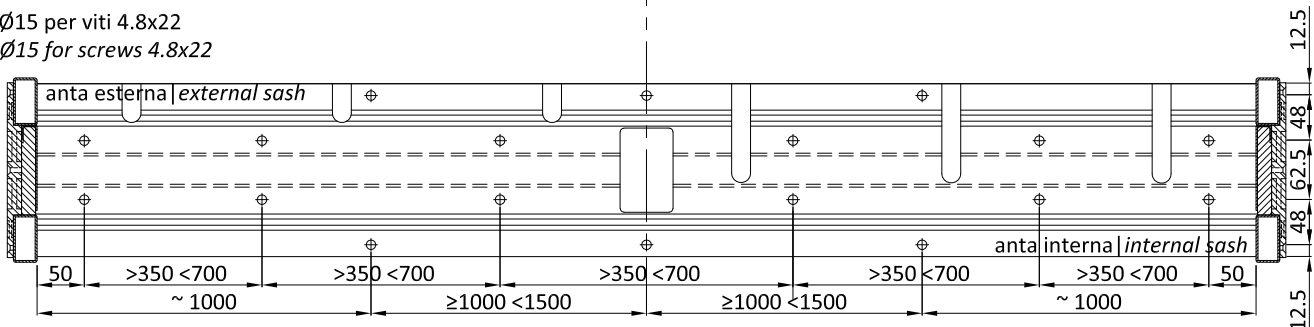

\* viti TC 4.8x22 non comprese | \* screws TC 4.8x22 not supplied

Schema | Type C

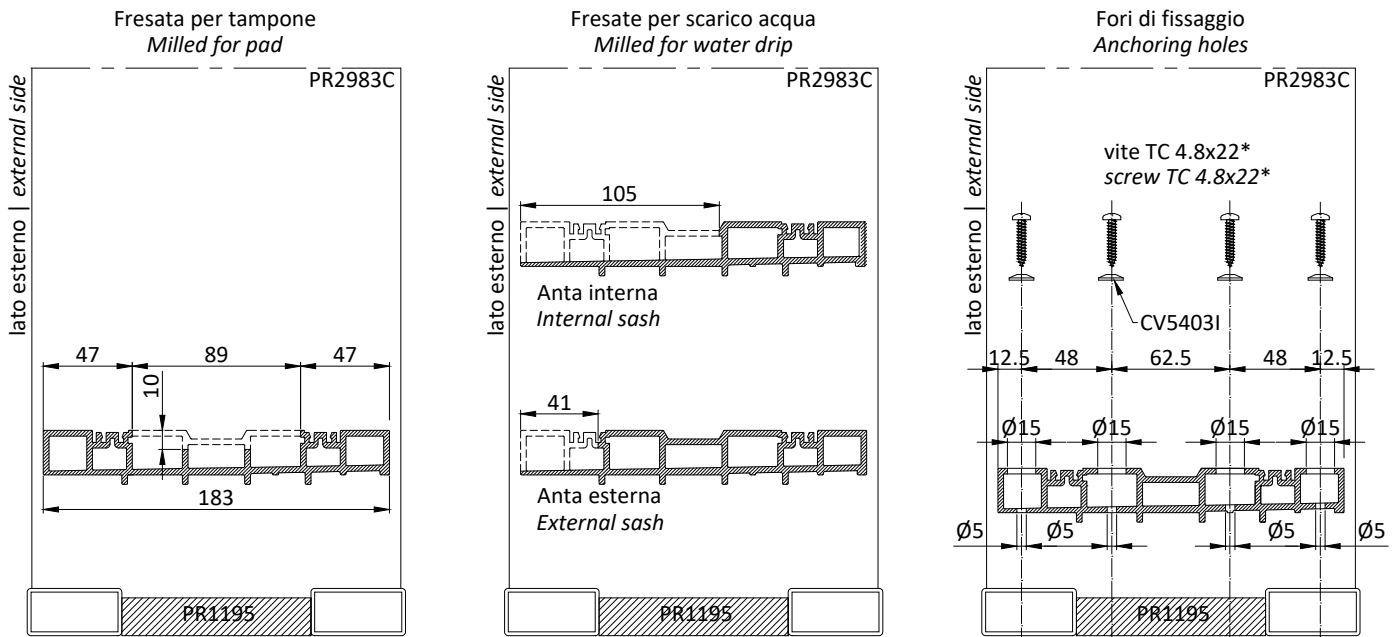
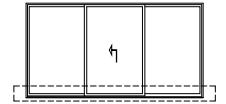

Fresate per scarico acqua e tamponi  
Milled for water drip and pads

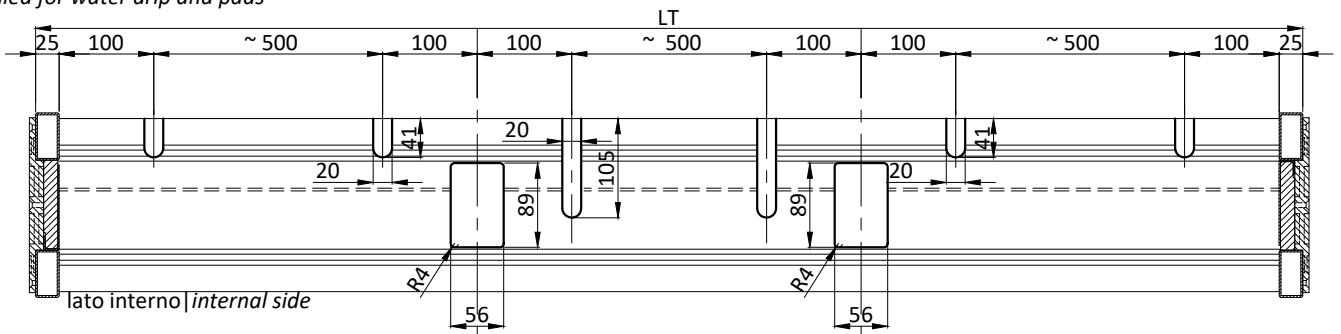

Foro Ø15 per viti 4.8x22  
Hole Ø15 for screws 4.8x22

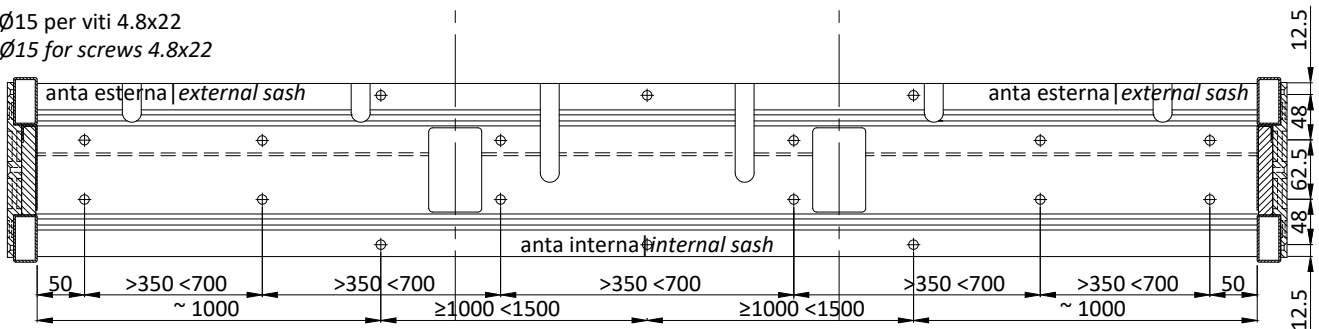

\* viti TC 4.8x22 non comprese | \* screws TC 4.8x22 not supplied

Schema | Type F

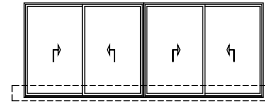

Schema | Type E

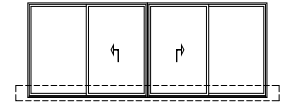

Fresata per tampone  
Milled for pad

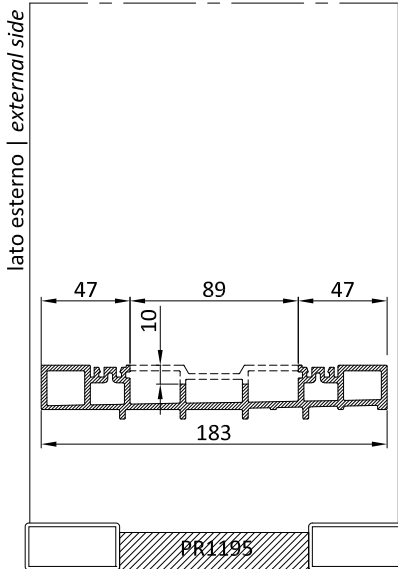

Fresate per scarico acqua  
Milled for water drip

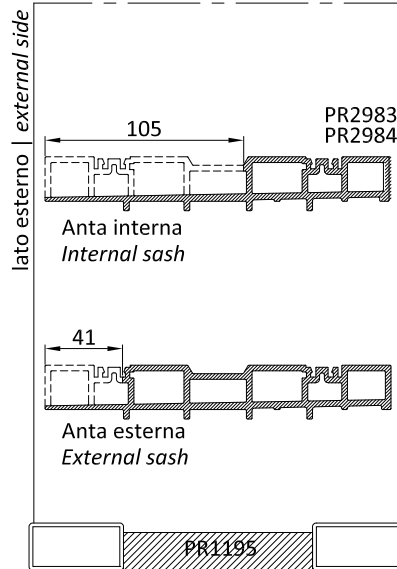

Fori di fissaggio  
Anchoring holes

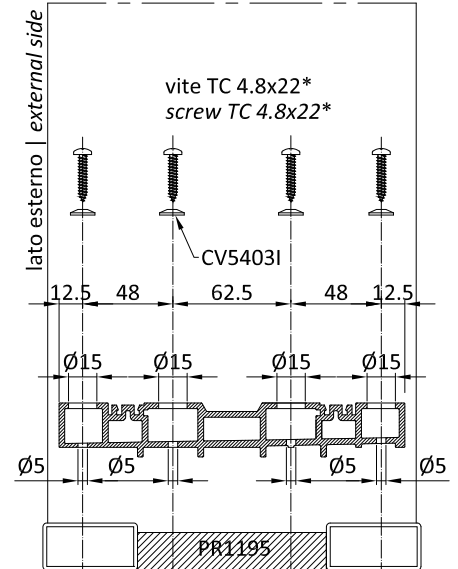

Fresate per scarico acqua e tamponi  
Milled for water drip and pads

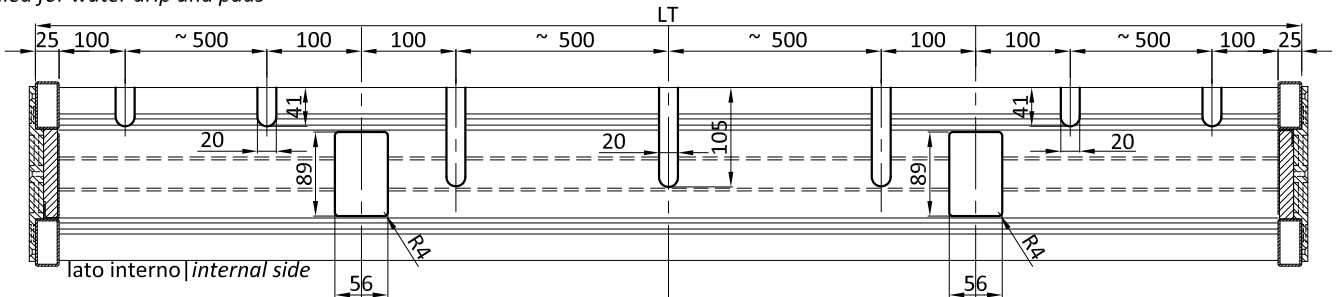

Foro Ø15 per viti 4.8x22  
Hole Ø15 for screws 4.8x22

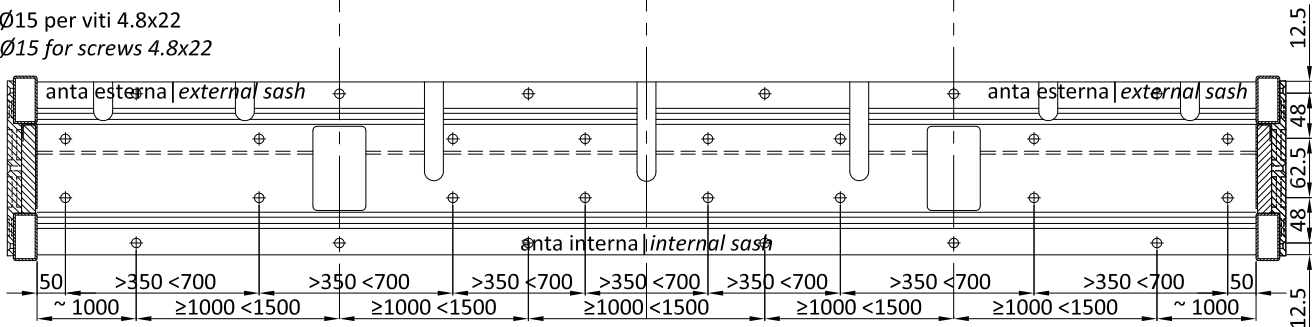

\* viti TC 4.8x22 non comprese | \* screws TC 4.8x22 not supplied

Schema | Type C3

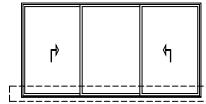

Schema | Type B3

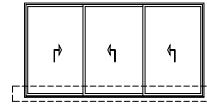

Schema | Type A3

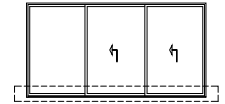

Fresata per tampone  
Milled for pad

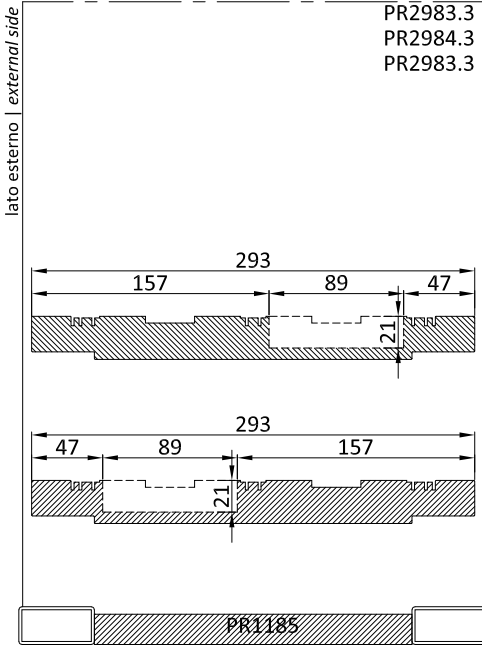

Fresate per scarico acqua  
Milled for water drip

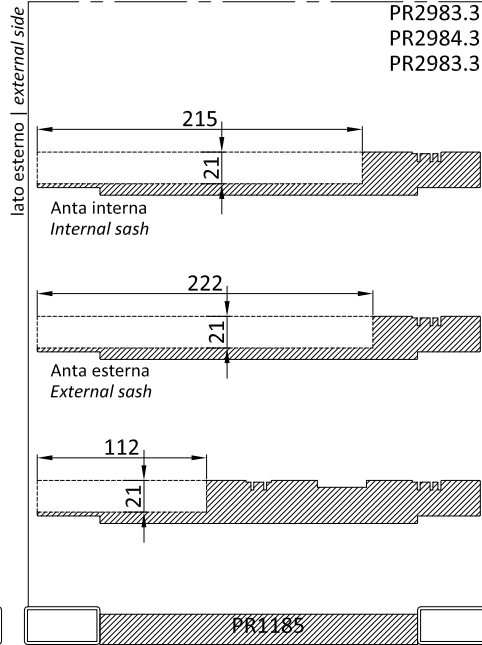

Fori di fissaggio  
Anchoring holes

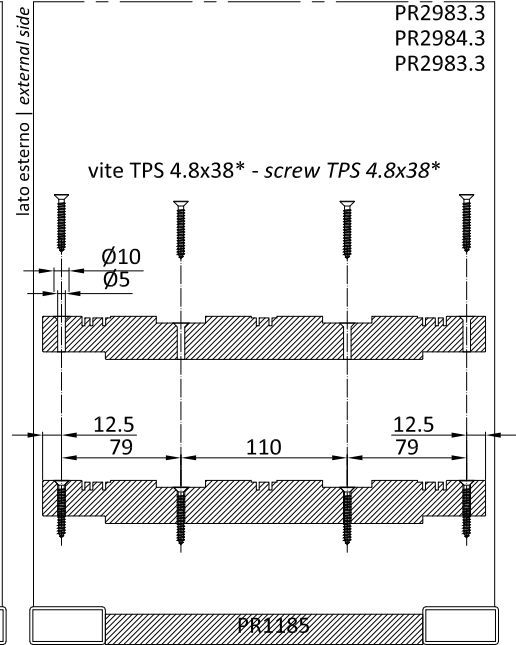

Fresate per scarico acqua e tamponi  
Milled for water drip and pads

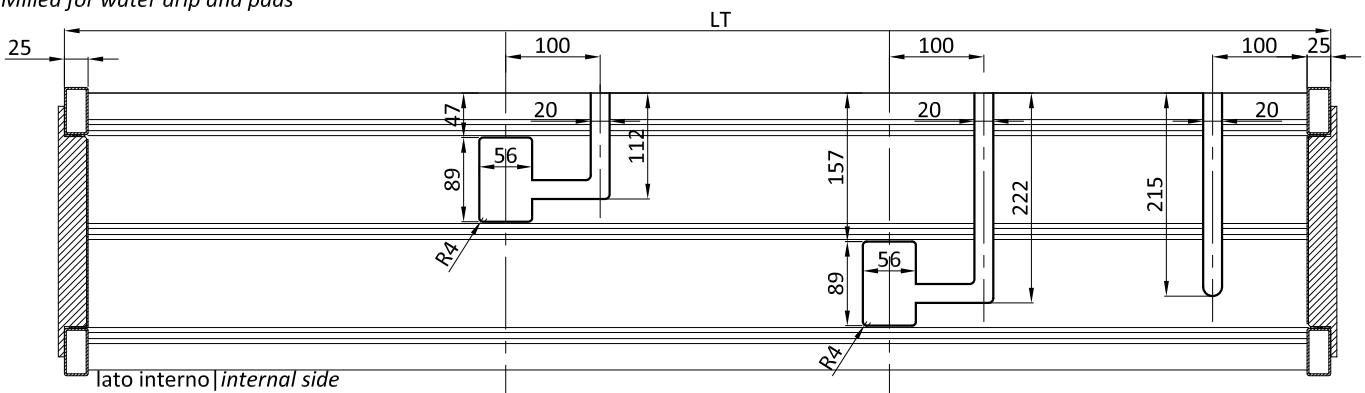

Foro Ø15 per viti 4.8x22  
Hole Ø15 for screws 4.8x22

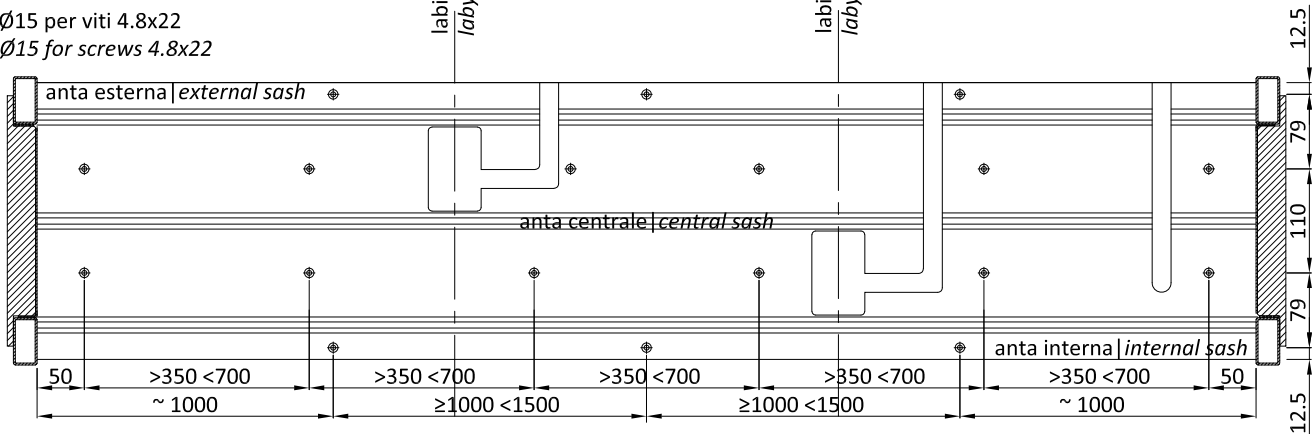

\* viti TC 4.8x22 non comprese | \* screws TC 4.8x22 not supplied

Schema | Type F3

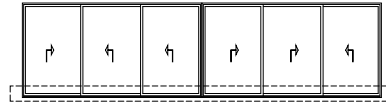

Schema | Type E3

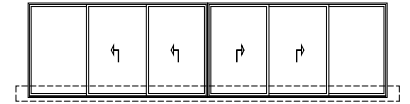

Fresata per tampone  
Milled for pad

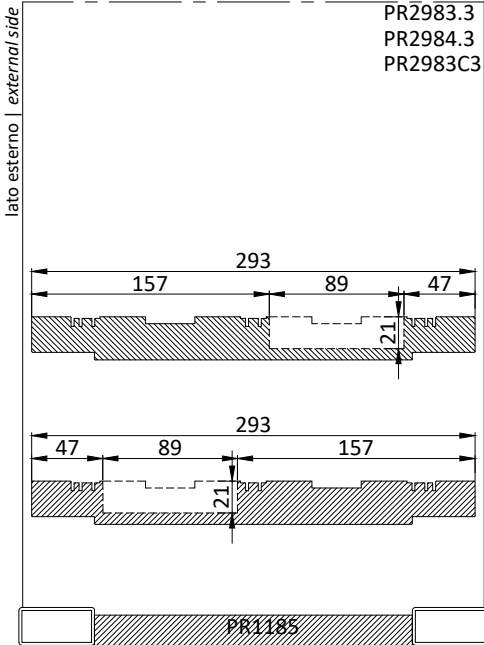

Fresate per scarico acqua  
Milled for water drip

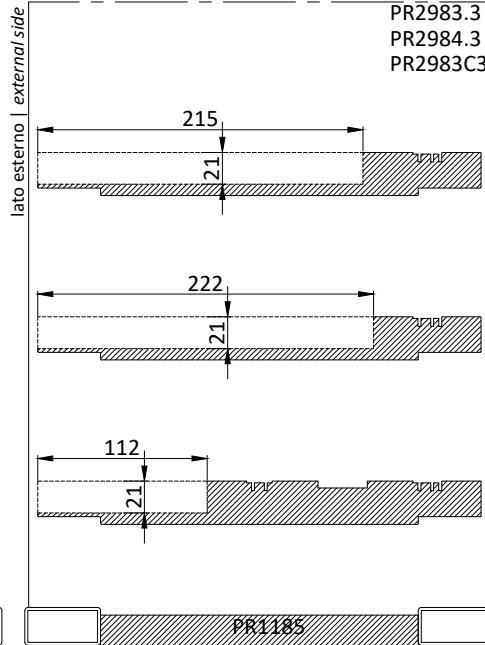

Fori di fissaggio  
Anchoring holes

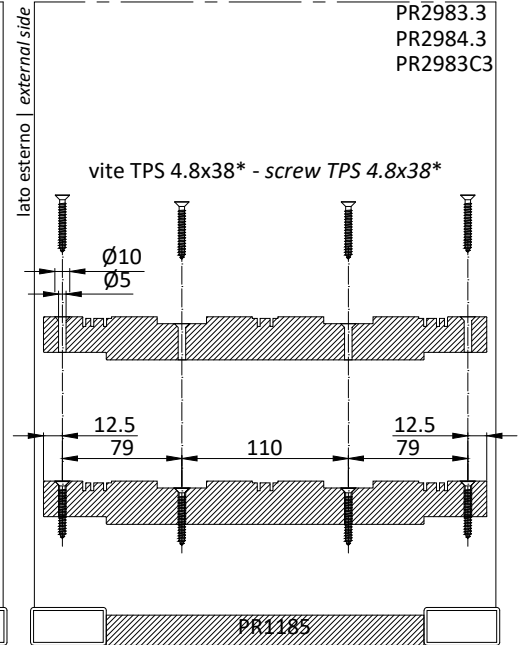

Fresate per scarico acqua e tamponi  
Milled for water drip and pads

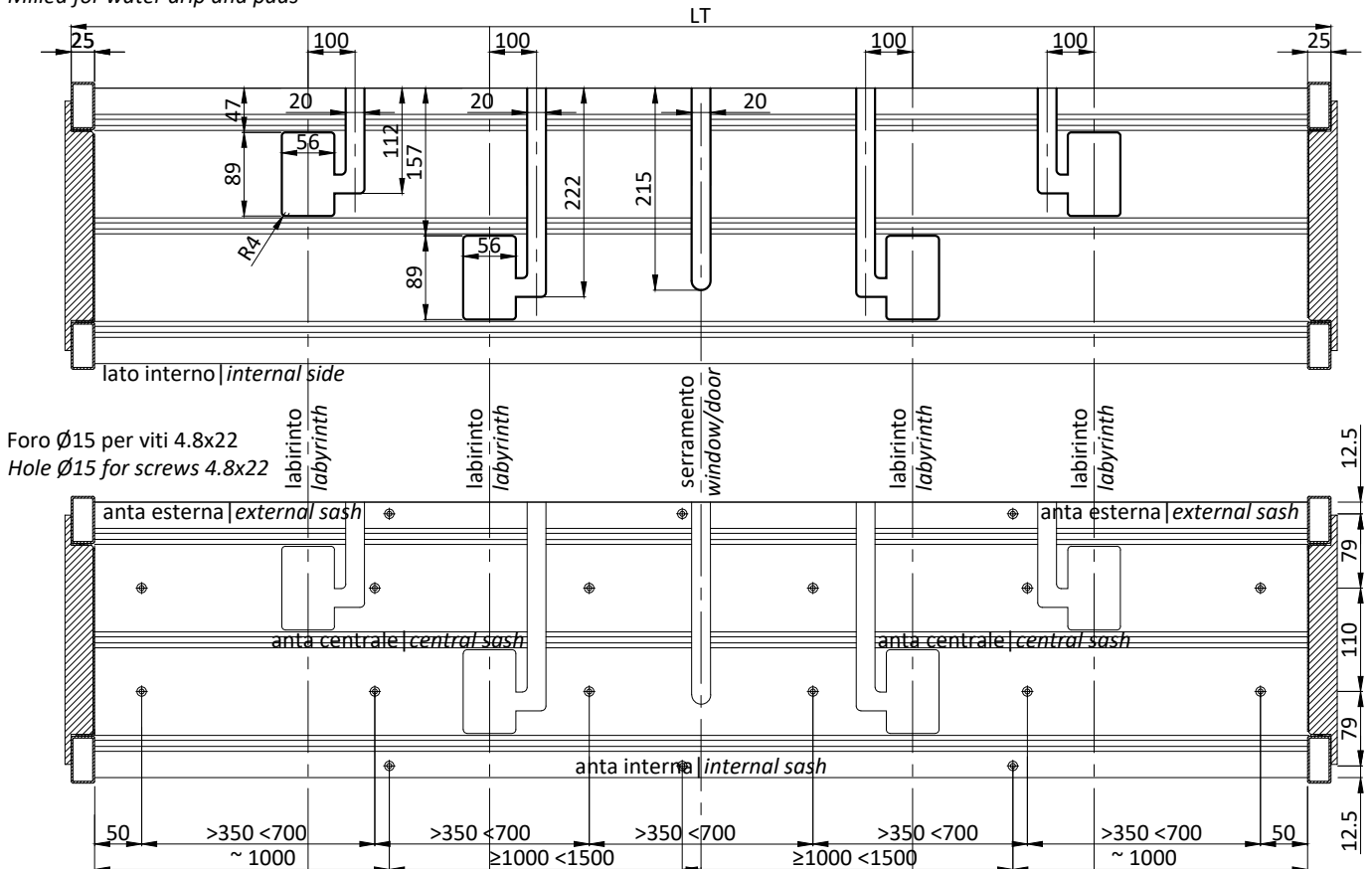

\* viti TPS 4.8x38 non comprese | \* screws TPS 4.8x38 not supplied



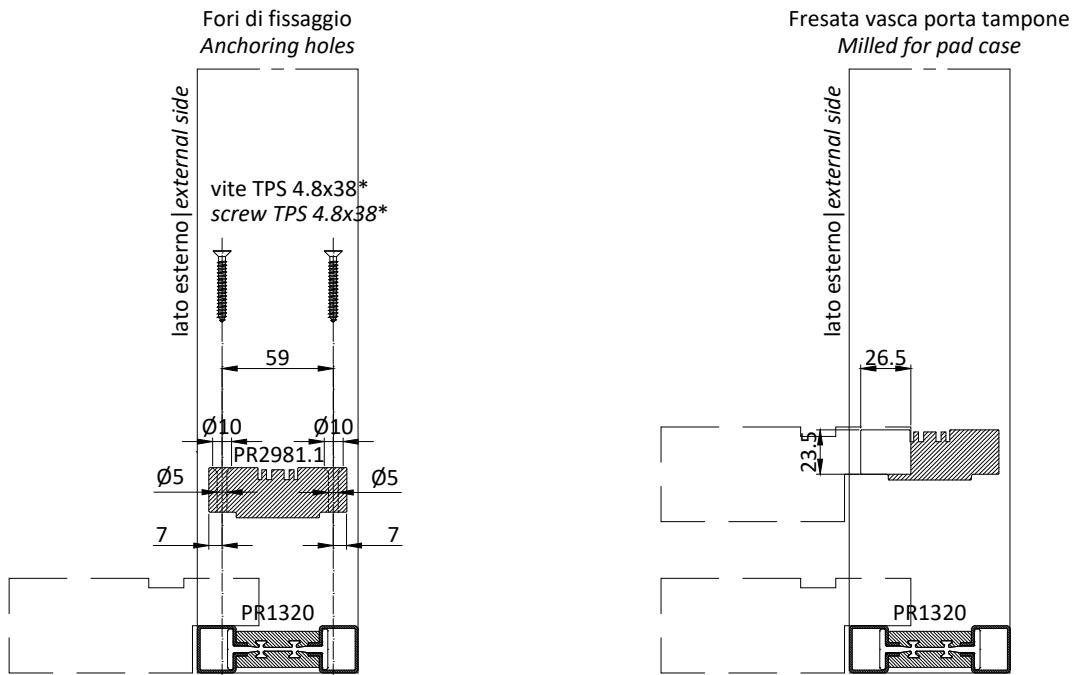
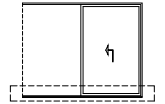

Fresate per scarico acqua e tamponi  
 Milled for water drip and pads

Fresata per vaschetta tampone  
 Milled for pad case

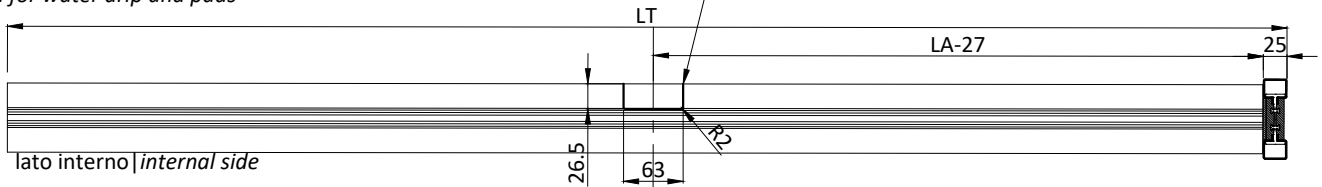

Foro Ø15 per viti 4.8x22  
 Hole Ø15 for screws 4.8x22

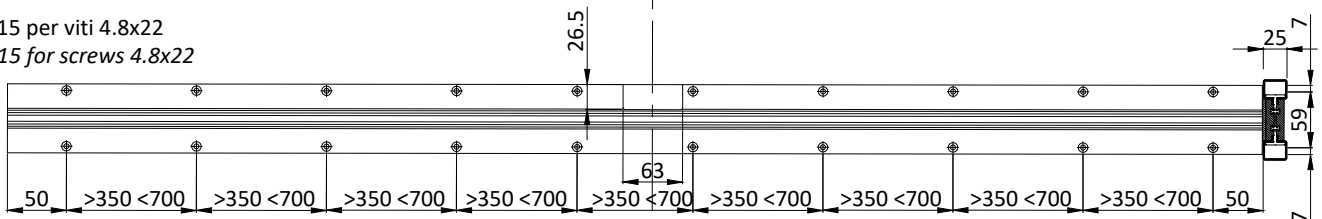

\* viti TPS 4.8x38 non comprese | \* screws TPS 4.8x38 not supplied

Schema | Type S2

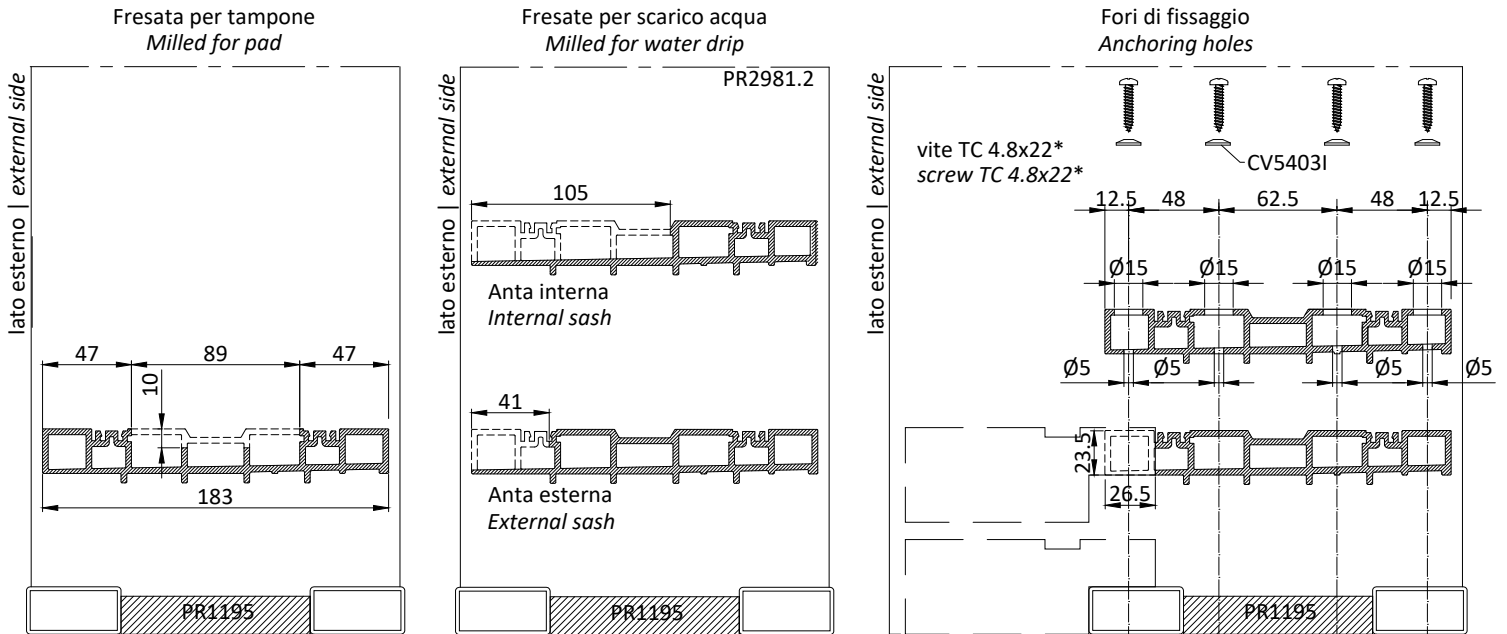
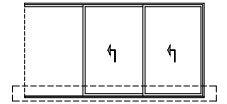

Fresate per scarico acqua e tamponi  
Milled for water drip and pads

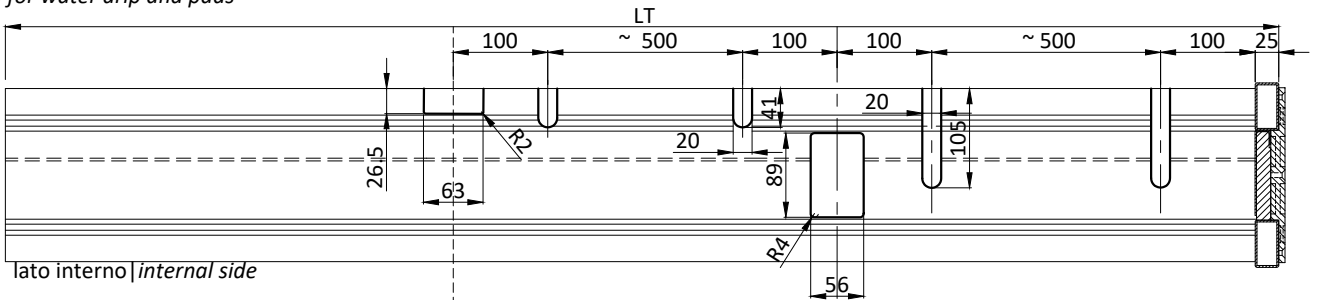

Foro Ø15 per viti 4.8x22  
Hole Ø15 for screws 4.8x22

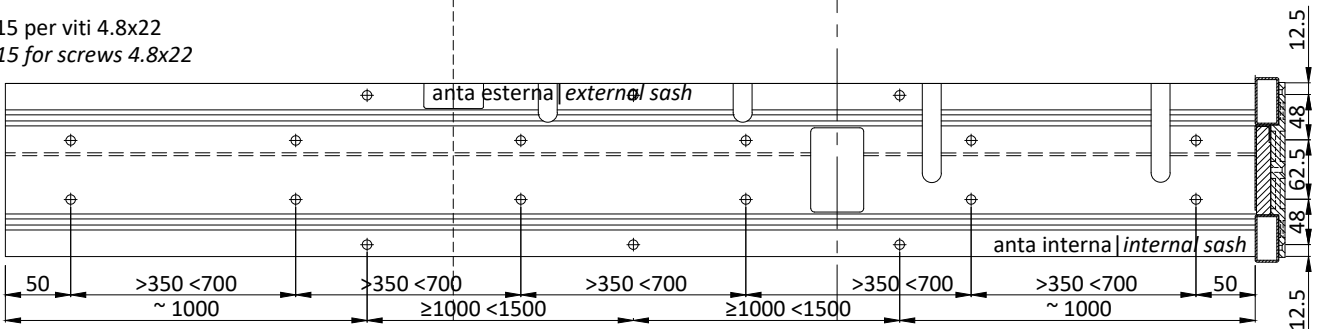

\* viti TC 4.8x22 non comprese | \* screws TC 4.8x22 not supplied

Schema | Type S3

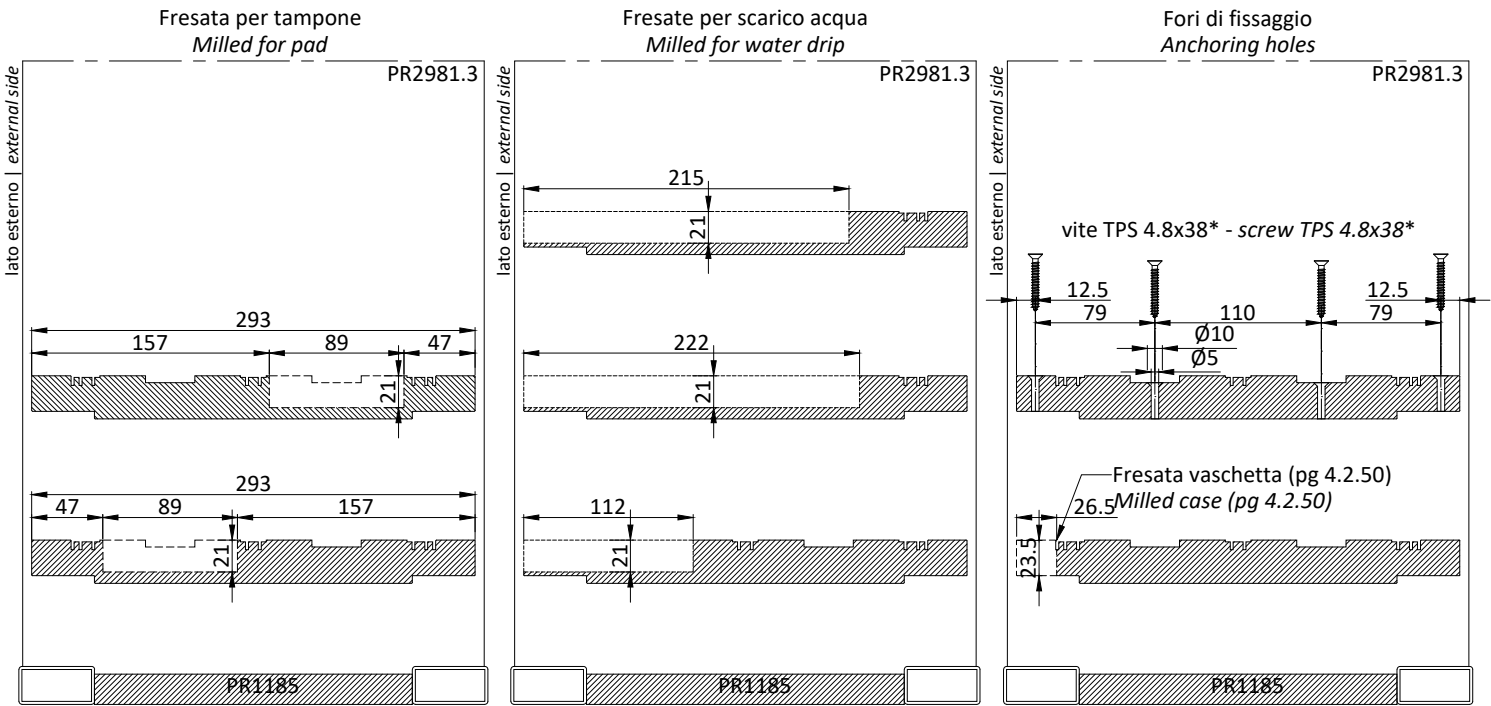
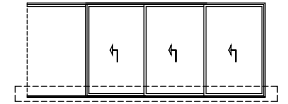

Fresate per scarico acqua e tamponi  
Milled for water drip and pads

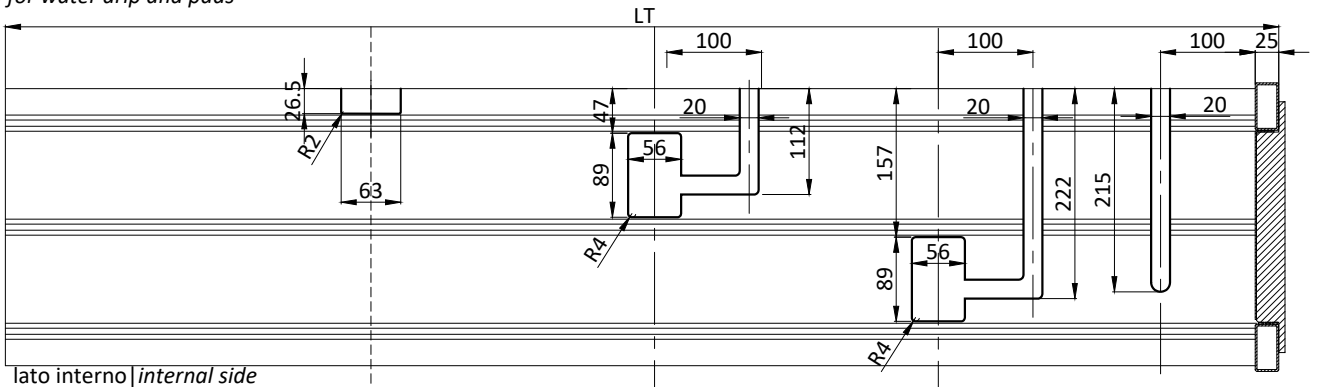

Foro Ø15 per viti 4.8x22  
Hole Ø15 for screws 4.8x22

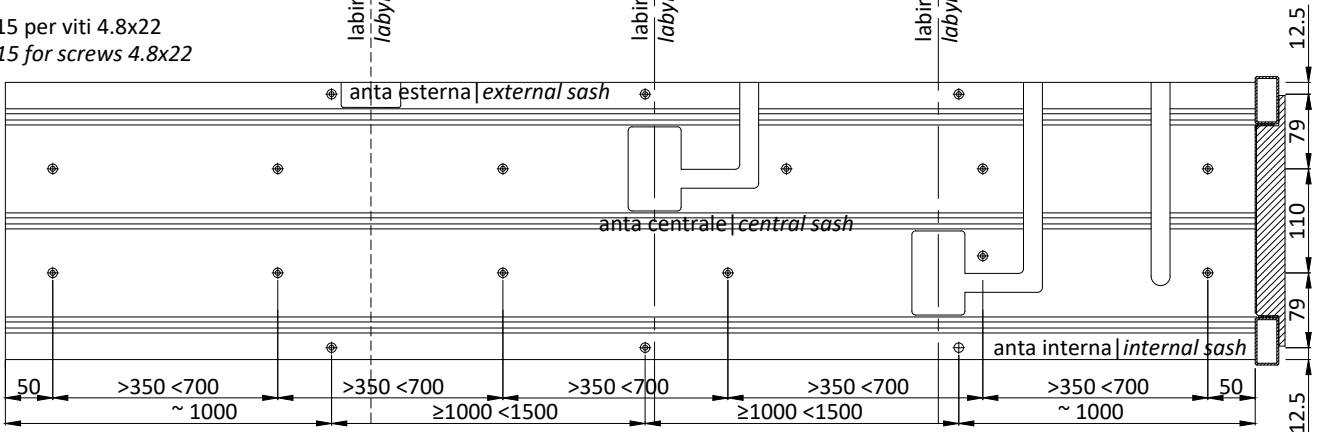

\* viti TPS 4.8x38 non comprese | \* screws TPS 4.8x38 not supplied

Schema | Type T1

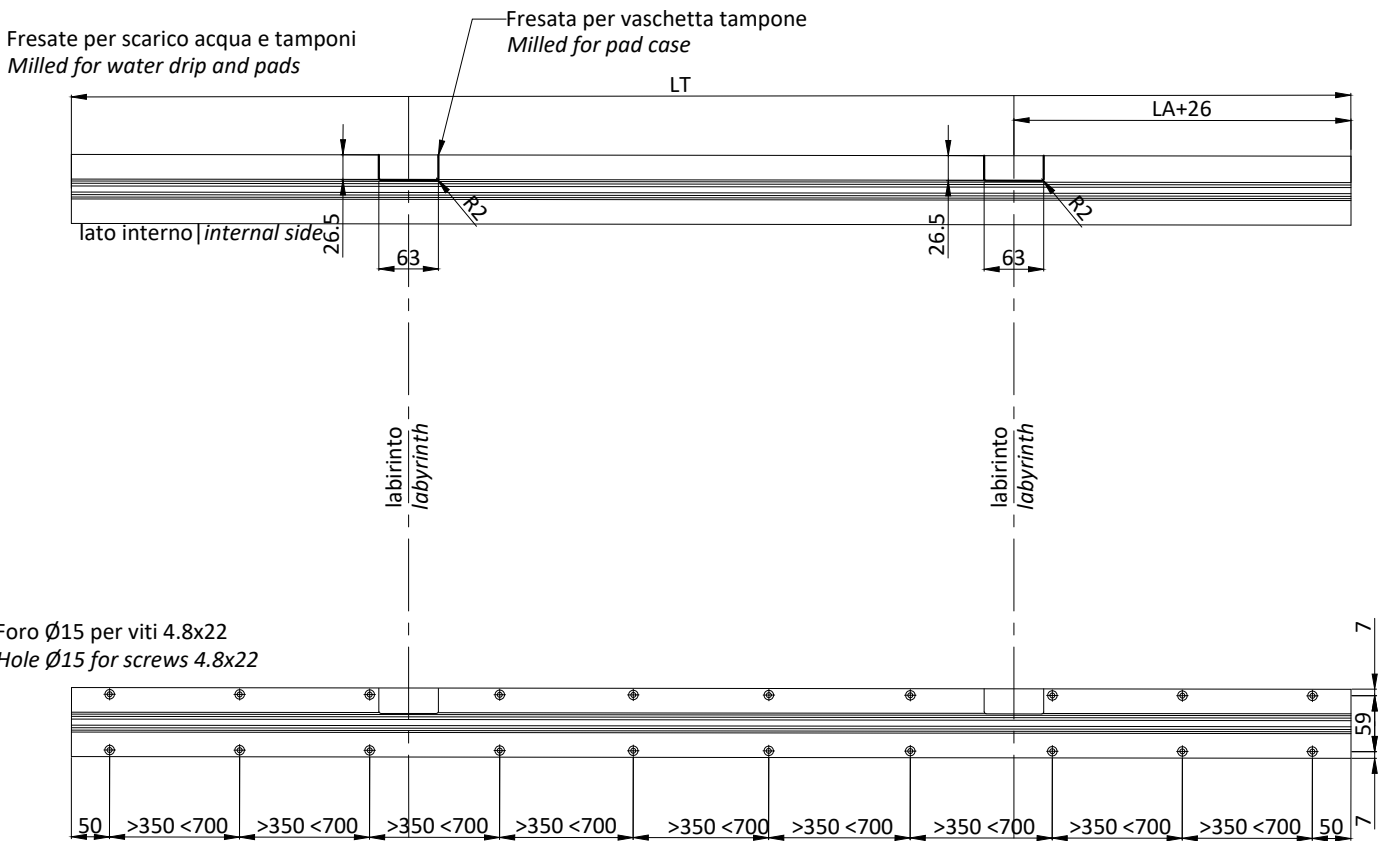
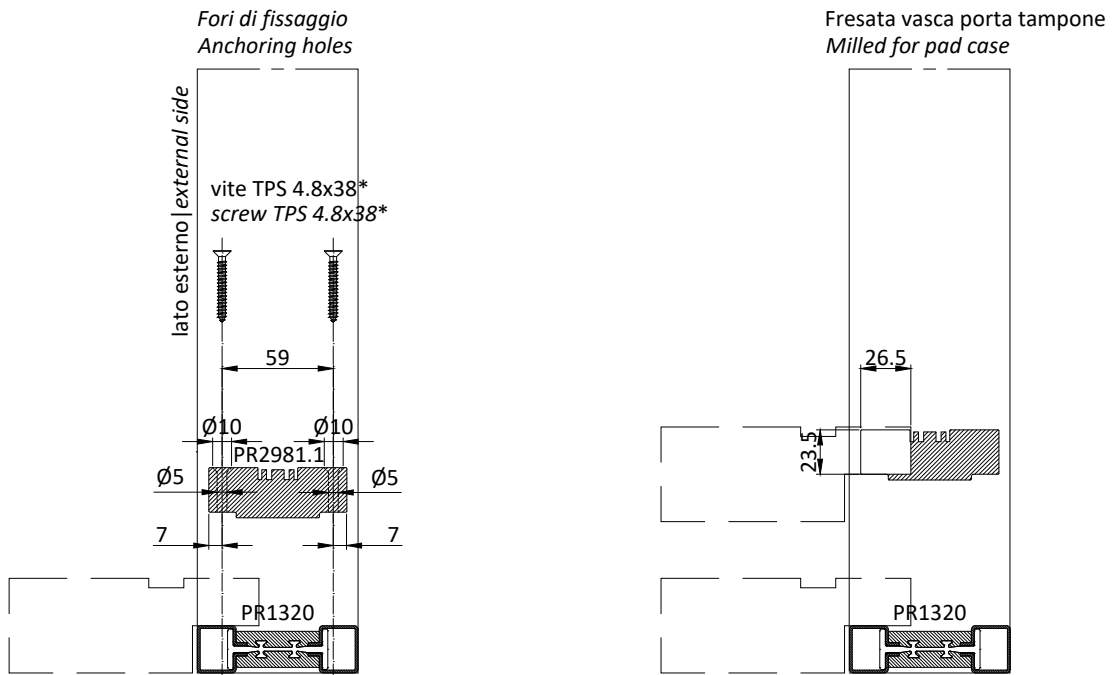
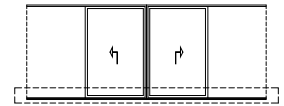

\* viti TPS 4.8x38 non comprese | \* screws TPS 4.8x38 not supplied



Schema | Type T2

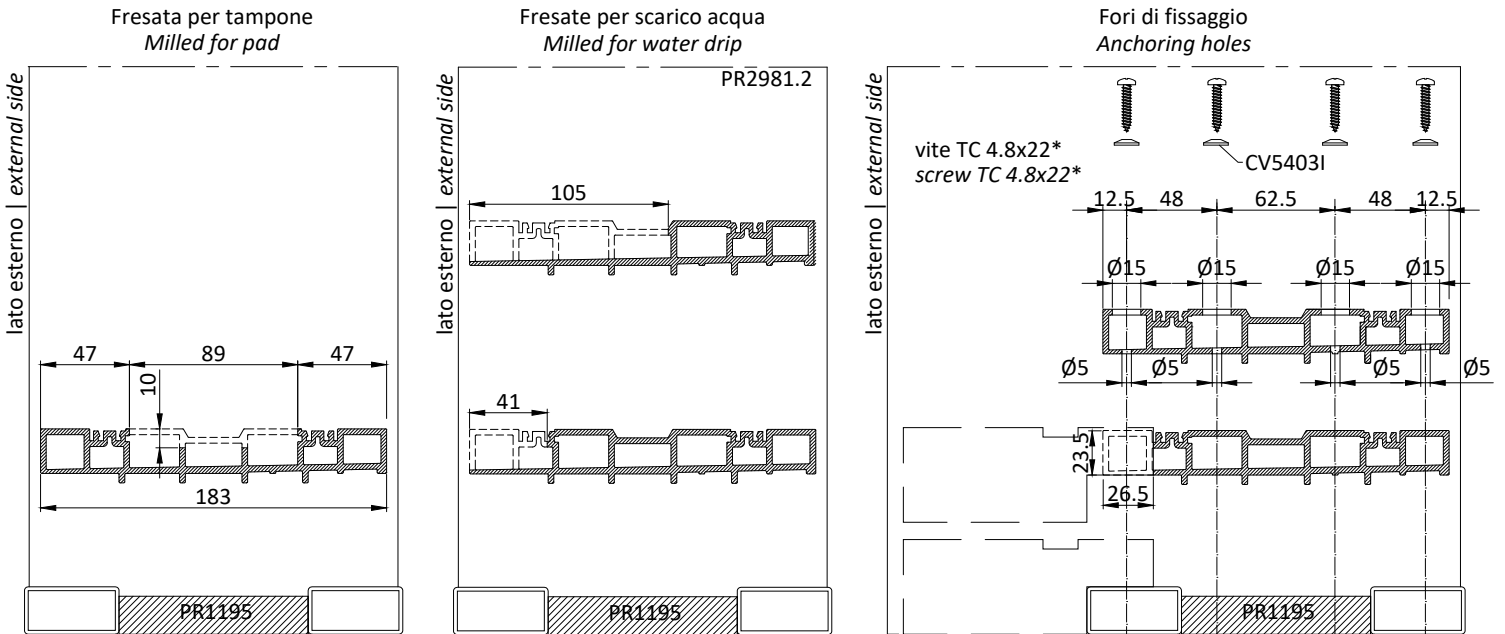
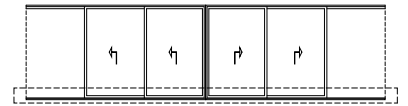

Fresate per scarico acqua e tamponi  
Milled for water drip and pads

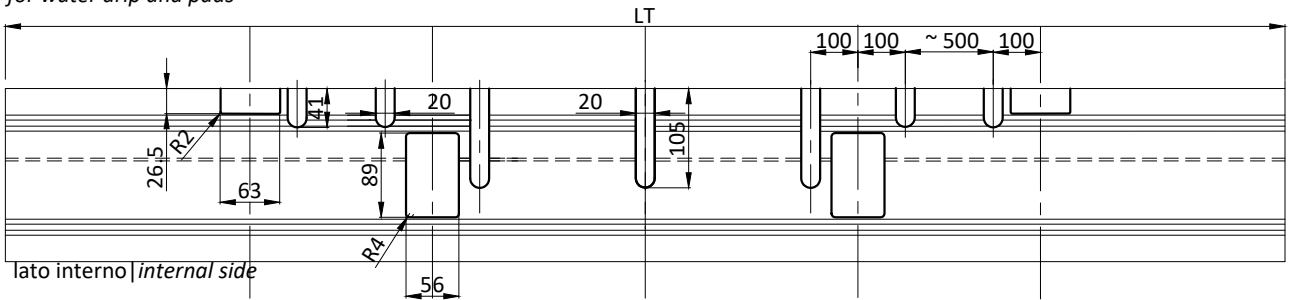

Foro Ø15 per viti 4.8x22  
Hole Ø15 for screws 4.8x22

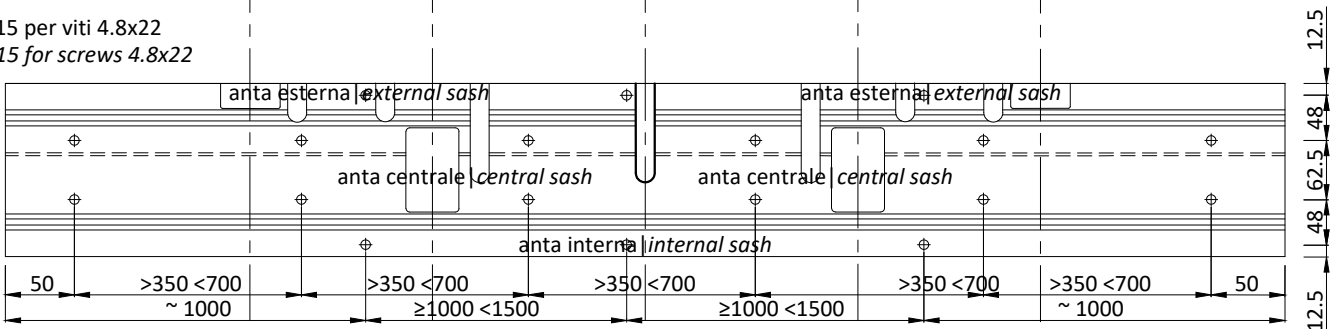

\* viti TC 4.8x22 non comprese | \* screws TC 4.8x22 not supplied

Schema | Type T3

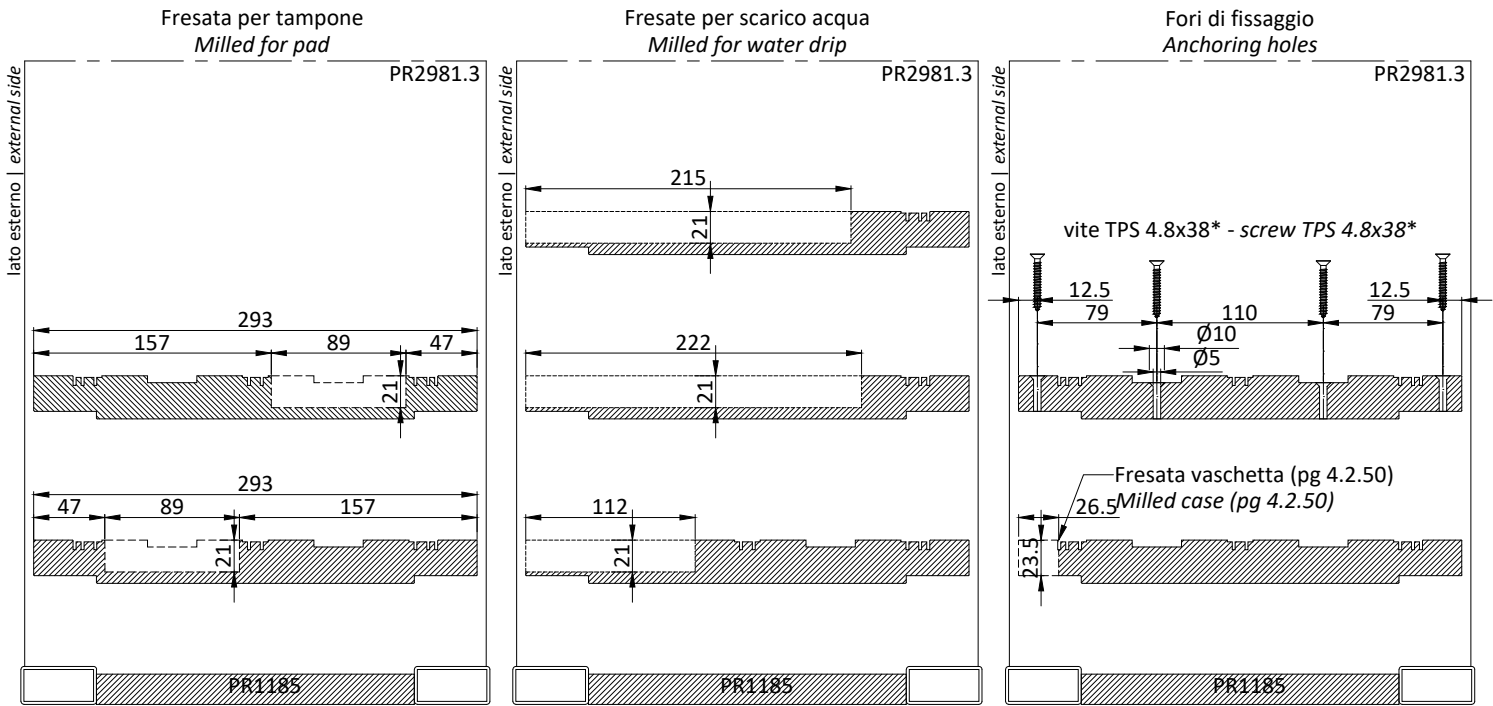
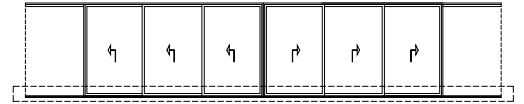

Fresate per scarico acqua e tamponi  
*Milled for water drip and pads*

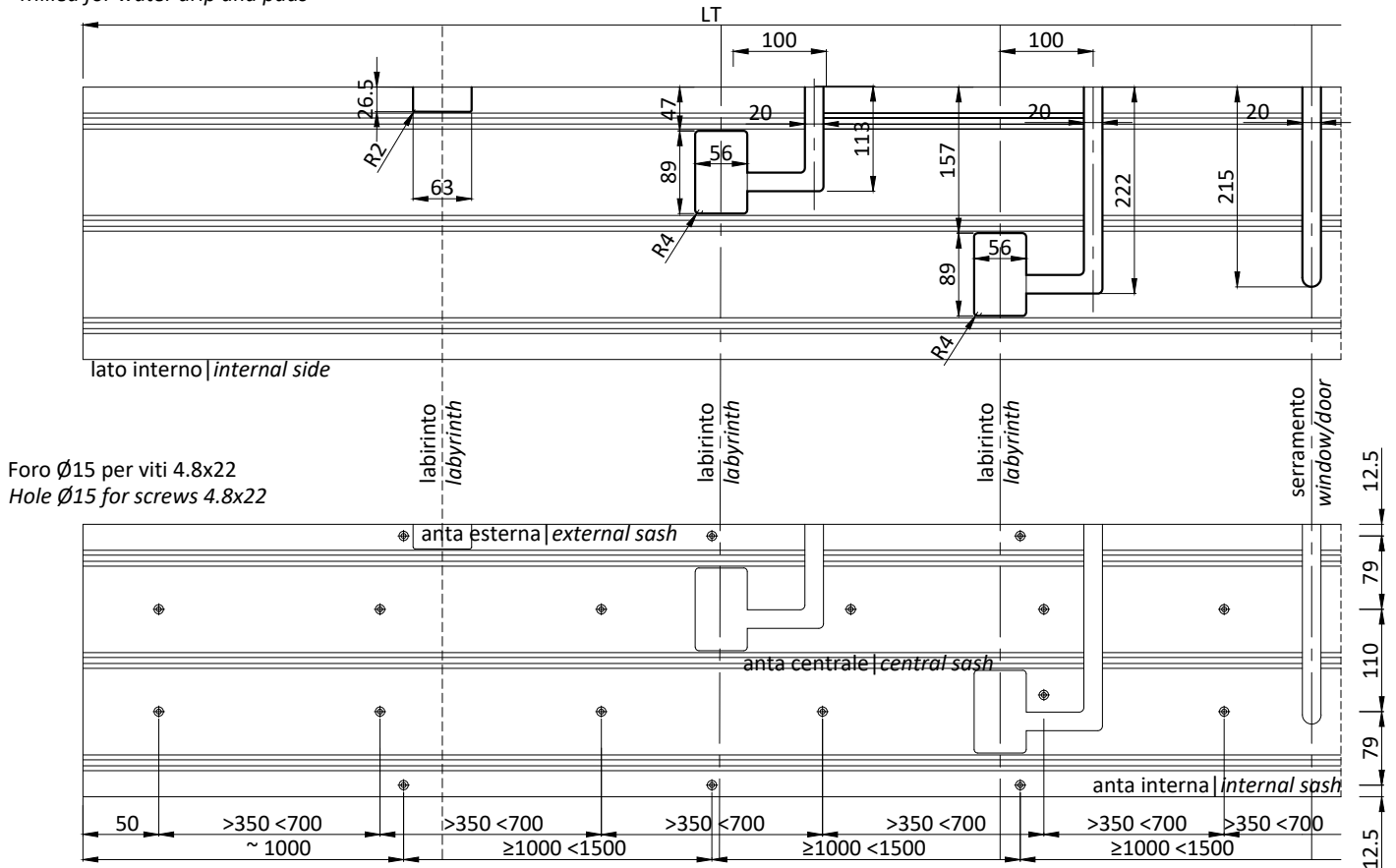

\* viti TPS 4.8x38 non comprese | \* screws TPS 4.8x38 not supplied

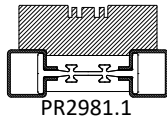

\*sigillare e accostare i profili  
\*seal and match the profiles

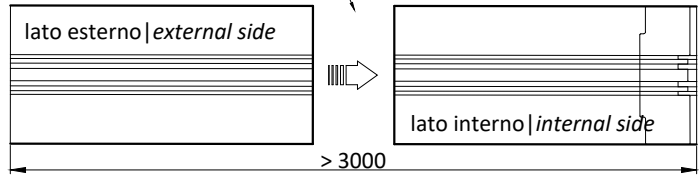
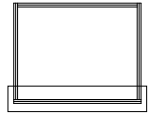

sigillare  
completamente  
tutte le camere  
seal all the chambers  
completely

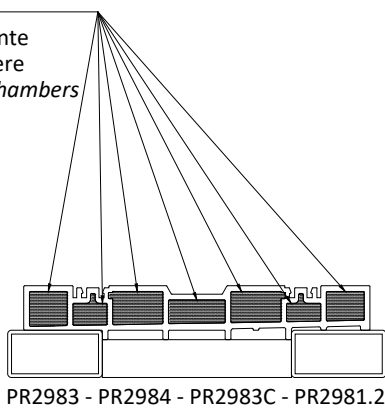

\*sigillare completamente tutte le camere e accostare i profili  
\*seal all chambers completely and match the profiles

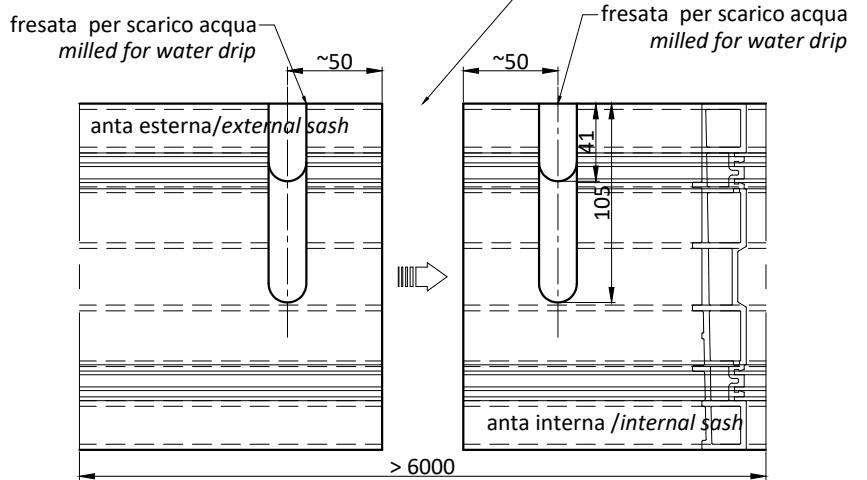

\*sigillare e accostare i profili  
\*seal and match the profiles

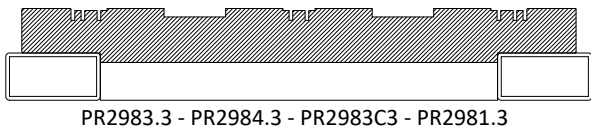
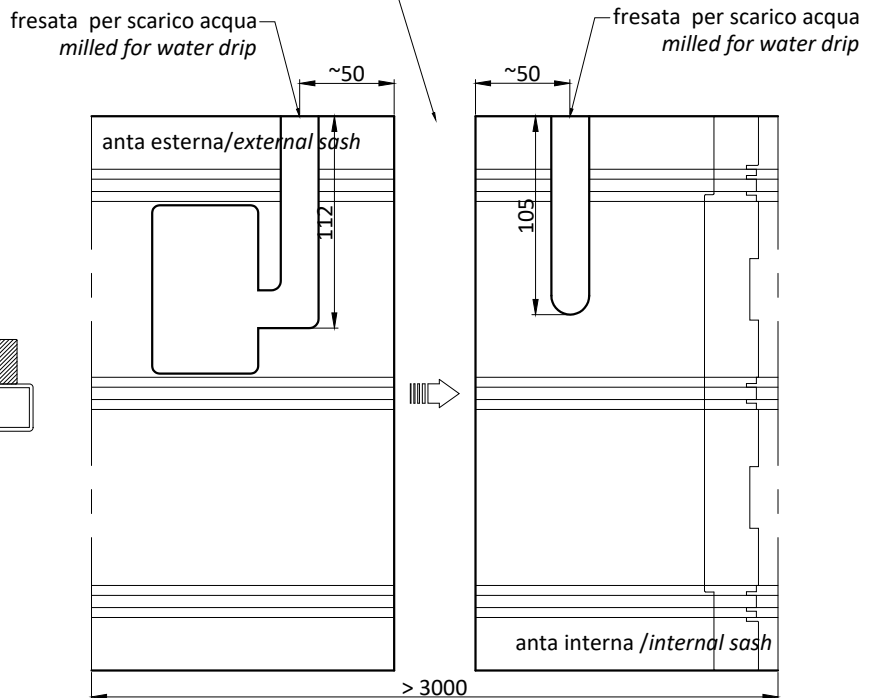

\* VIETATA la giunzione in asse del labirinto dove viene eseguita la fresatura per il tampone ed in asse centrale del serramento dove si incontrano le due ante interne ed è realizzato lo scarico acqua centrale  
\* FORBIDDEN the junction on the axis of the labyrinth where milling is carried out for the pad and on the central axis of the door/window where the two internal sashes meet and the main water drip is located

PR2983

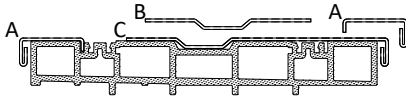

Schema | Type A

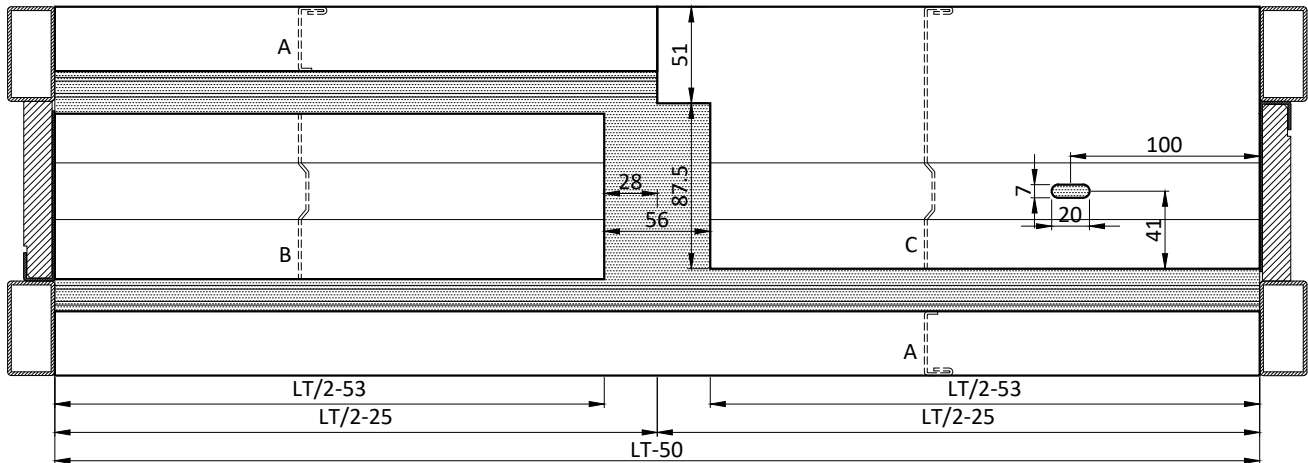
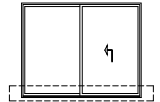

PR2984

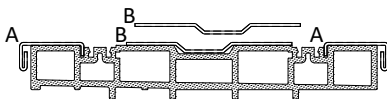

Schema | Type B

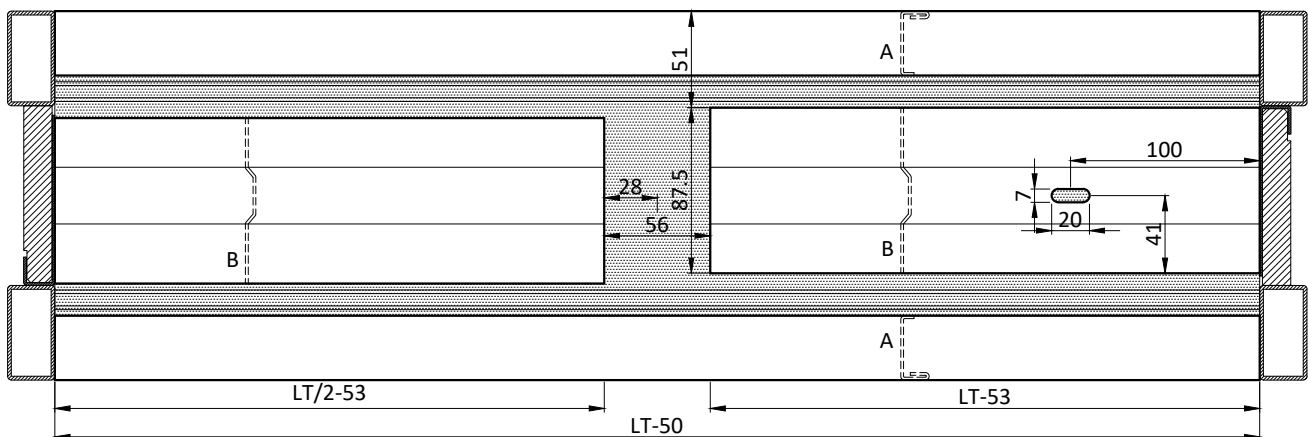
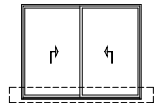

Le copertine in metallo devono essere fissate al profilo estruso PR2983-PR2984 mediante incollaggio con silicone

*The metal covers have to be attached to the extrusion profile PR2983-PR2984 with silicon*

La copertina A interna va posizionata dopo il fissaggio del serramento a terra

*Internal cover A must be put in place once the window/door has been attached on the ground*



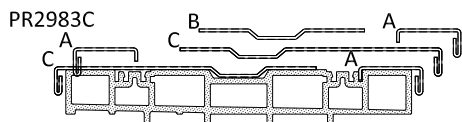

Schema | Type C

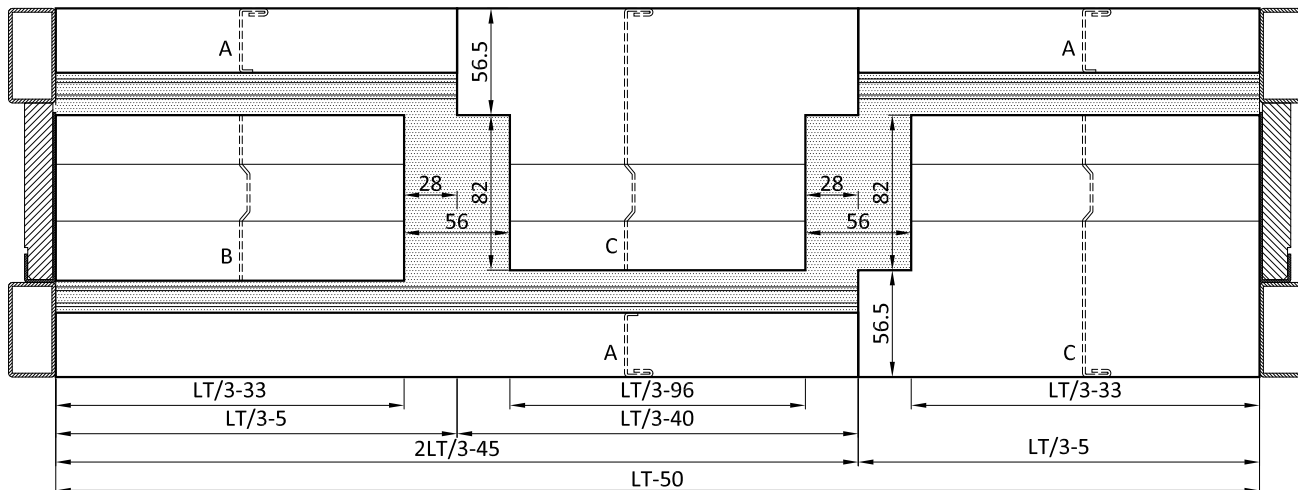
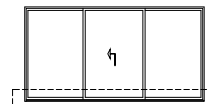

PR2983

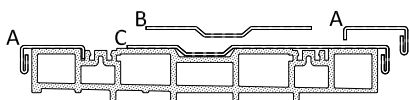

Schema | Type E

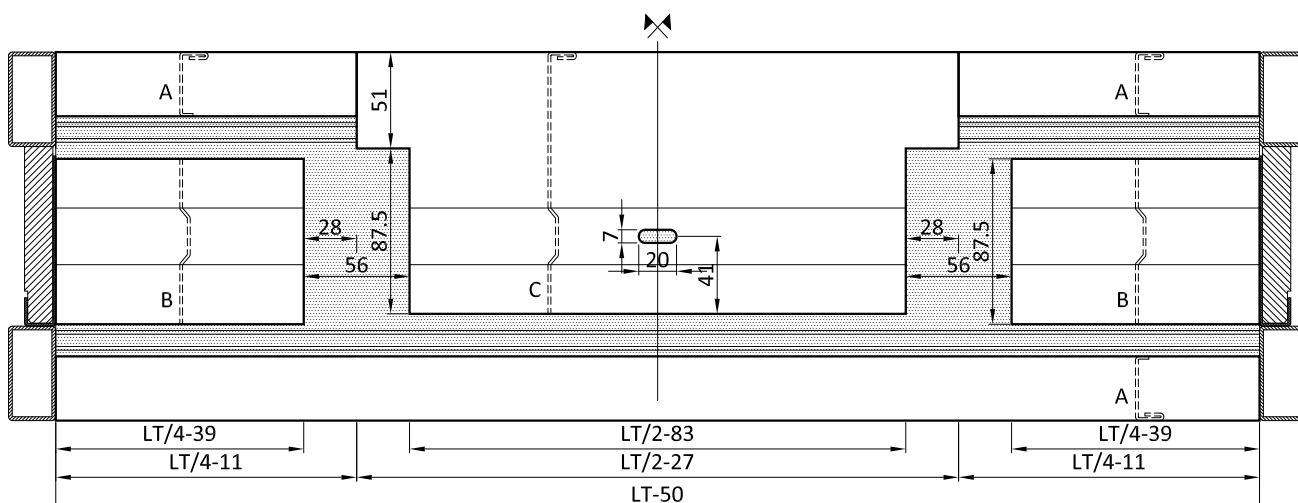
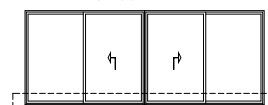

Le copertine in metallo devono essere fissate al profilo estruso PR2983C-PR2983 mediante incollaggio con silicone  
 The metal covers have to be attached to the extrusion profile PR2983C-PR2983 with silicon  
 La copertina A interna va posizionata dopo il fissaggio del serramento a terra  
 Internal cover A must be put in place once the window/door has been attached on the ground

PR2984

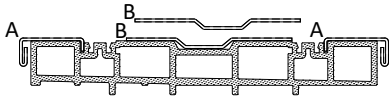

Schema | Type F

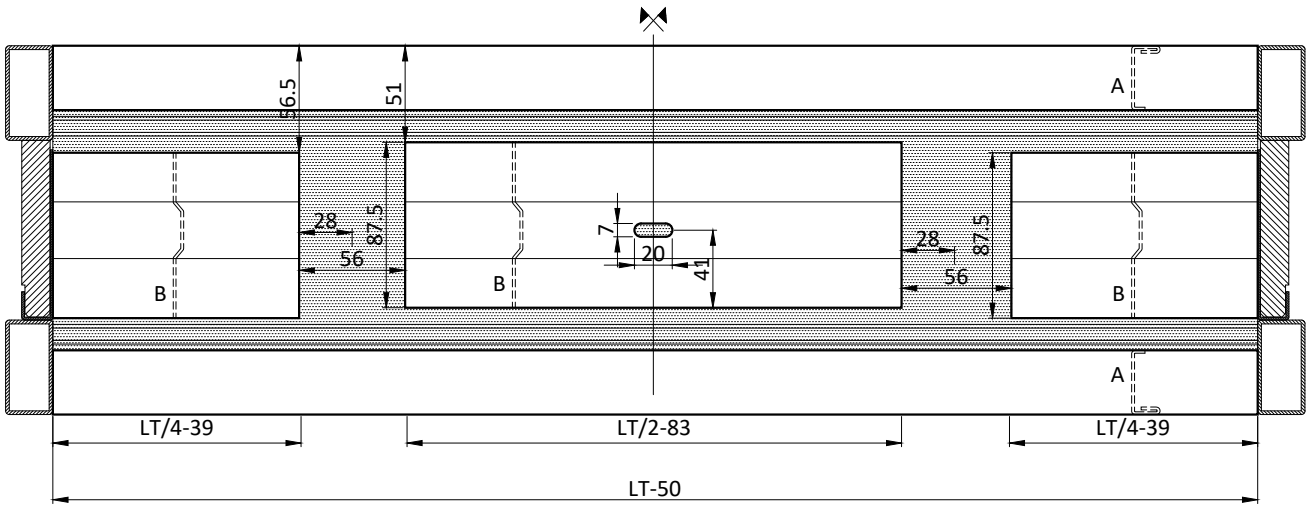
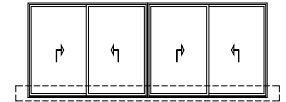

PR2983.3

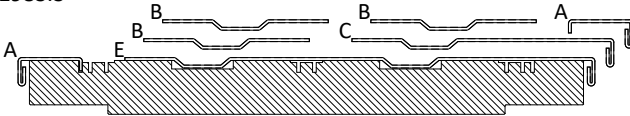

Schema | Type A3

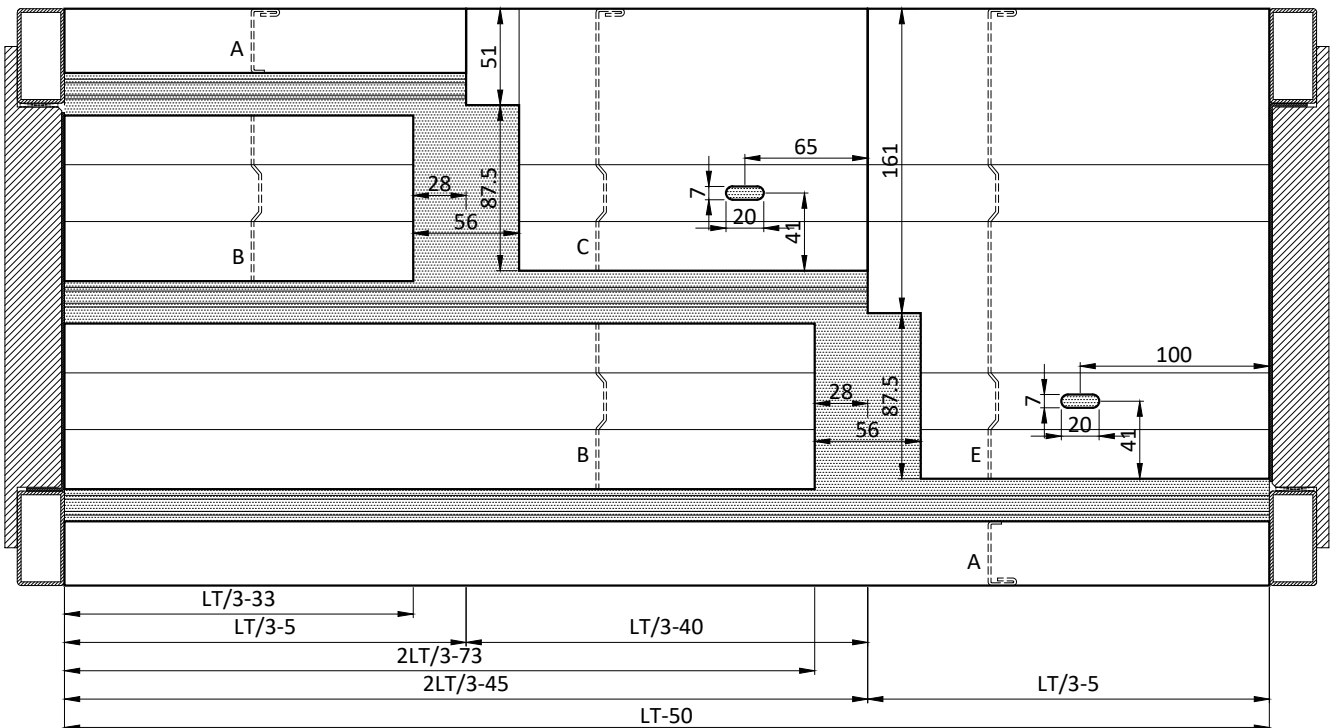
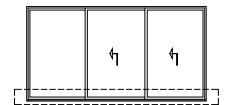

Le copertine in metallo devono essere fissate al profilo estruso PR2984-PR2983.3 mediante incollaggio con silicone  
 The metal covers have to be attached to the extrusion profile PR2984-PR2983.3 with silicon  
 La copertina A interna va posizionata dopo il fissaggio del serramento a terra  
 Internal cover A must be put in place once the window/door has been attached on the ground

PR2984.3

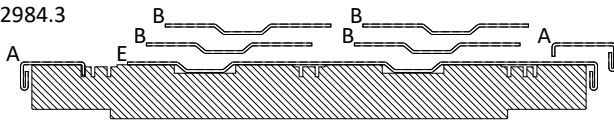

Schema | Type B3

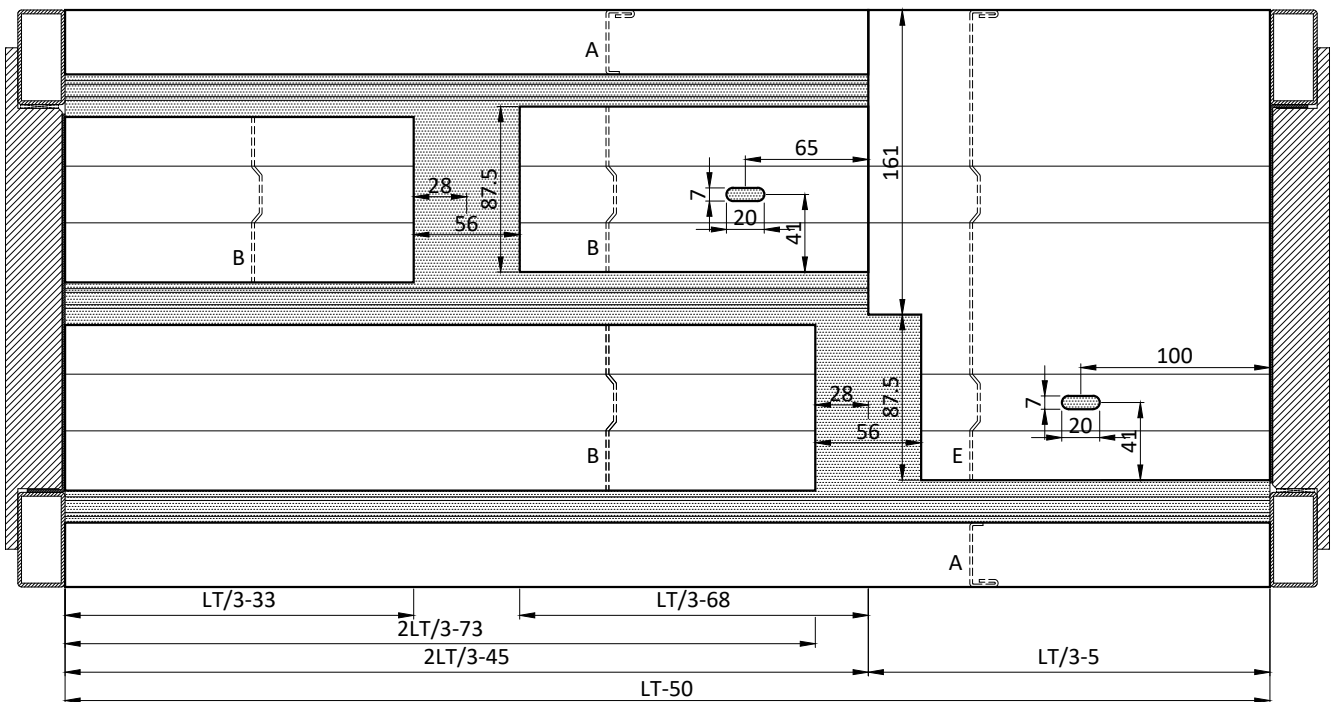
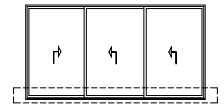

PR2983C.3

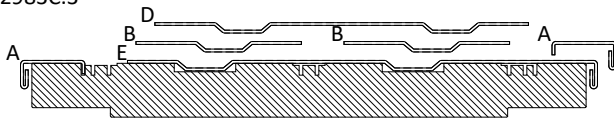

Schema | Type C3

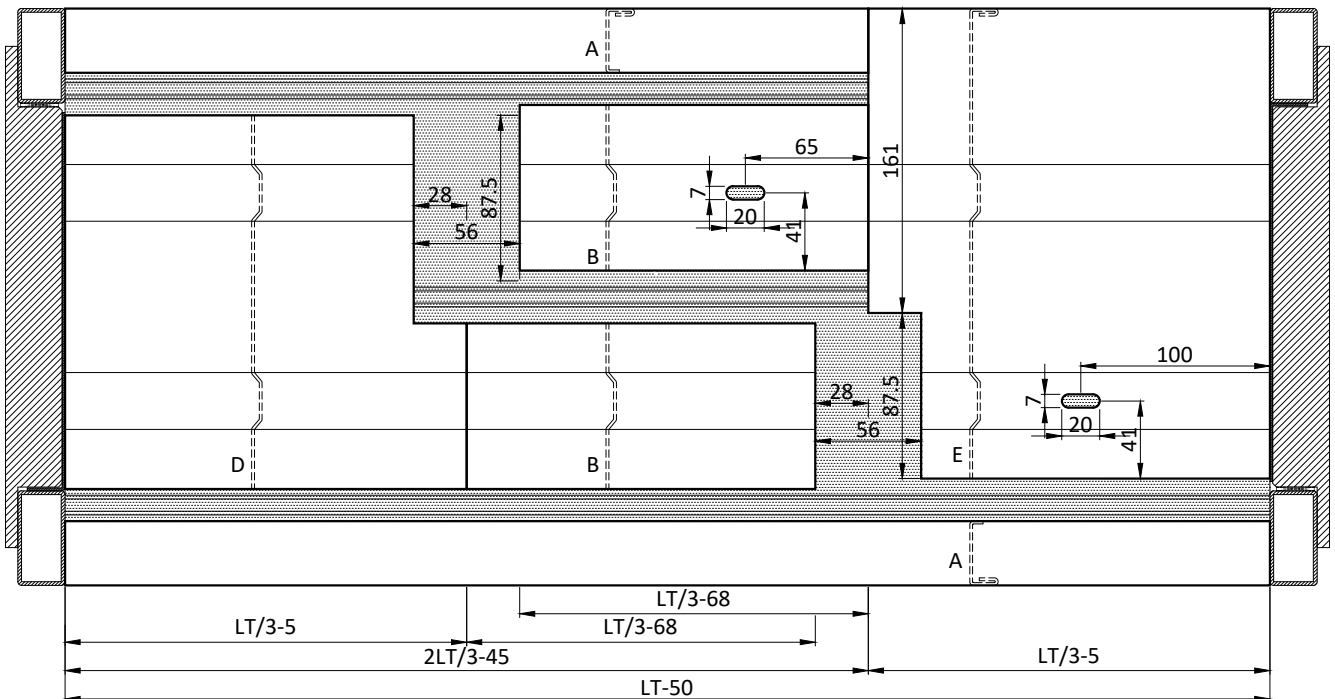
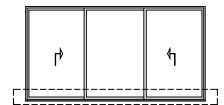

Le copertine in metallo devono essere fissate al profilo estruso PR2984.3-PR2983C3.3 mediante incollaggio con silicone

The metal covers have to be attached to the extrusion profile PR2984.3-PR2983C3.3 with silicon

La copertina A interna va posizionata dopo il fissaggio del serramento a terra

Internal cover A must be put in place once the window/door has been attached on the ground

PR2983.3

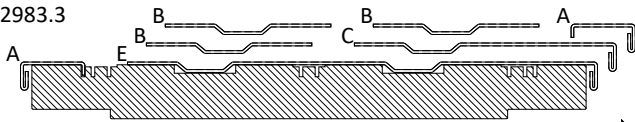

Schema | Type E3

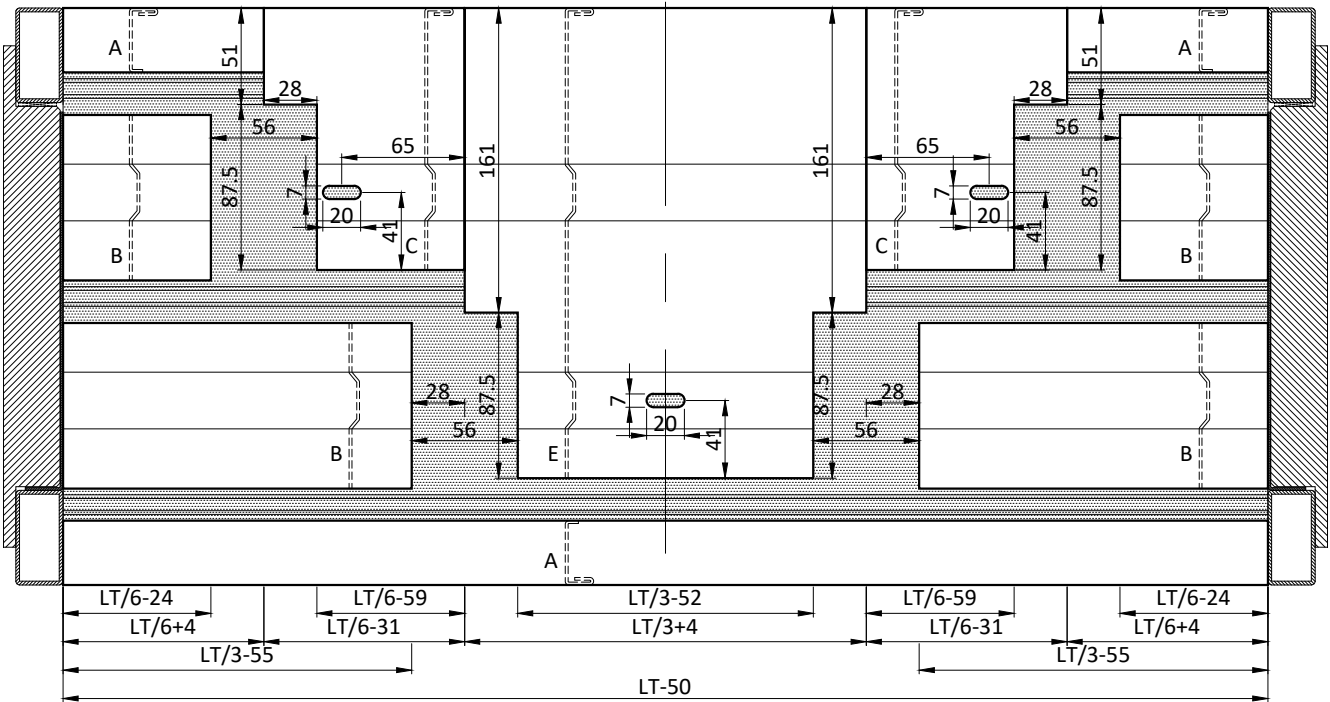
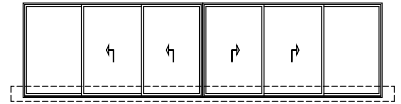

PR2984.3

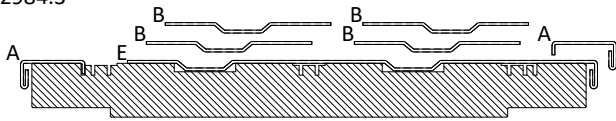

Schema | Type E3

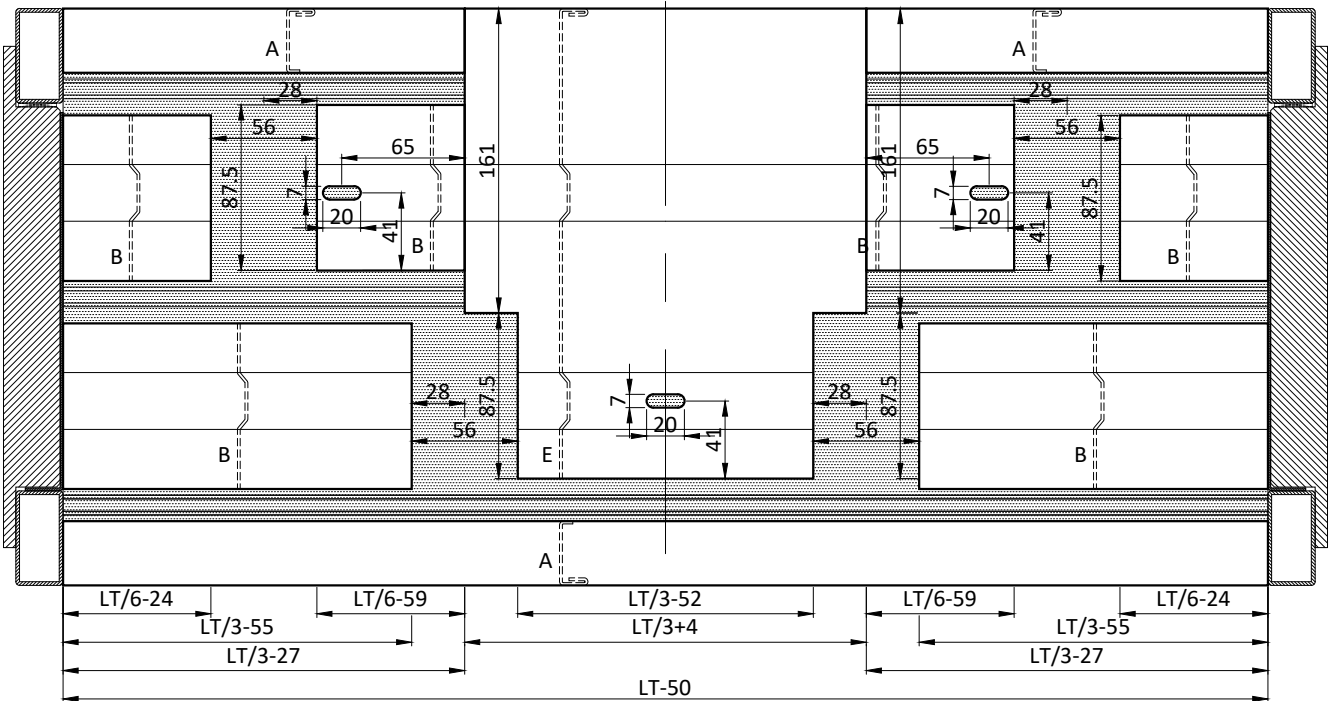
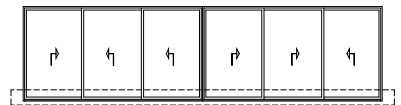

Le copertine in metallo devono essere fissate al profilo estruso PR2983.3-PR2984.3 mediante incollaggio con silicone  
 The metal covers have to be attached to the extrusion profile PR2983.3-PR2984.3 with silicon  
 La copertina A interna va posizionata dopo il fissaggio del serramento a terra  
 Internal cover A must be put in place once the window/door has been attached on the ground

PR2981.1

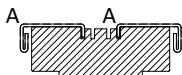

Schema | Type S1

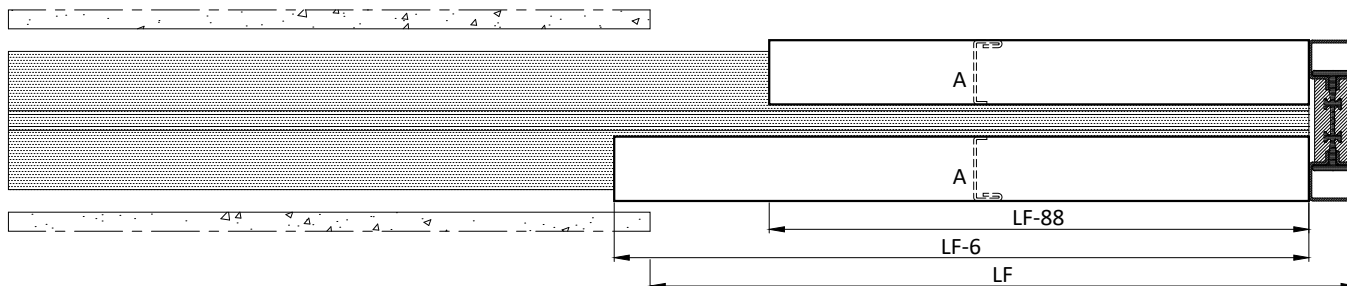
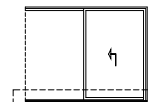

PR2981.2

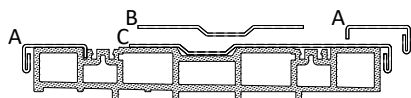

Schema | Type S2

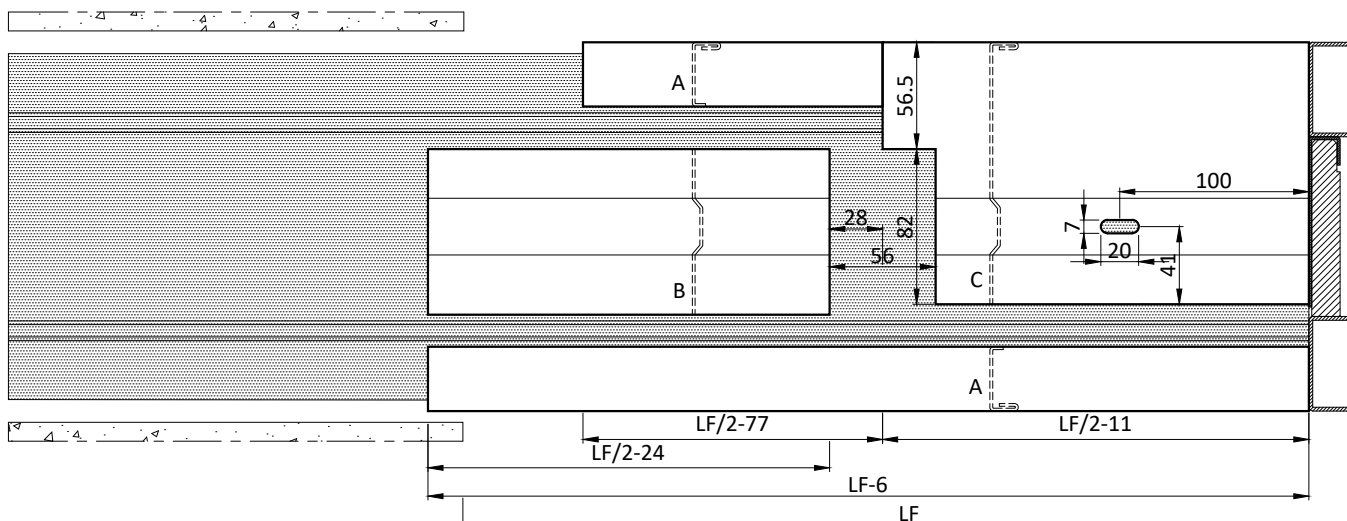
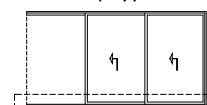

Le copertine in metallo devono essere fissate al profilo estruso PR2981.1-PR2981.2 mediante incollaggio con silicone

The metal covers have to be attached to the extrusion profile PR2981.1-PR2981.2 with silicon

La copertina A interna va posizionata dopo il fissaggio del serramento a terra

Internal cover A must be put in place once the window/door has been attached on the ground

PR2981.3

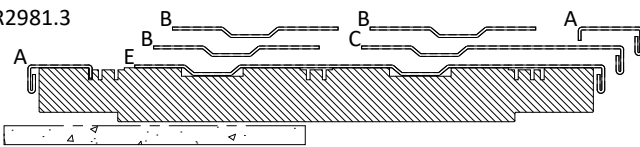

Schema | Type S3

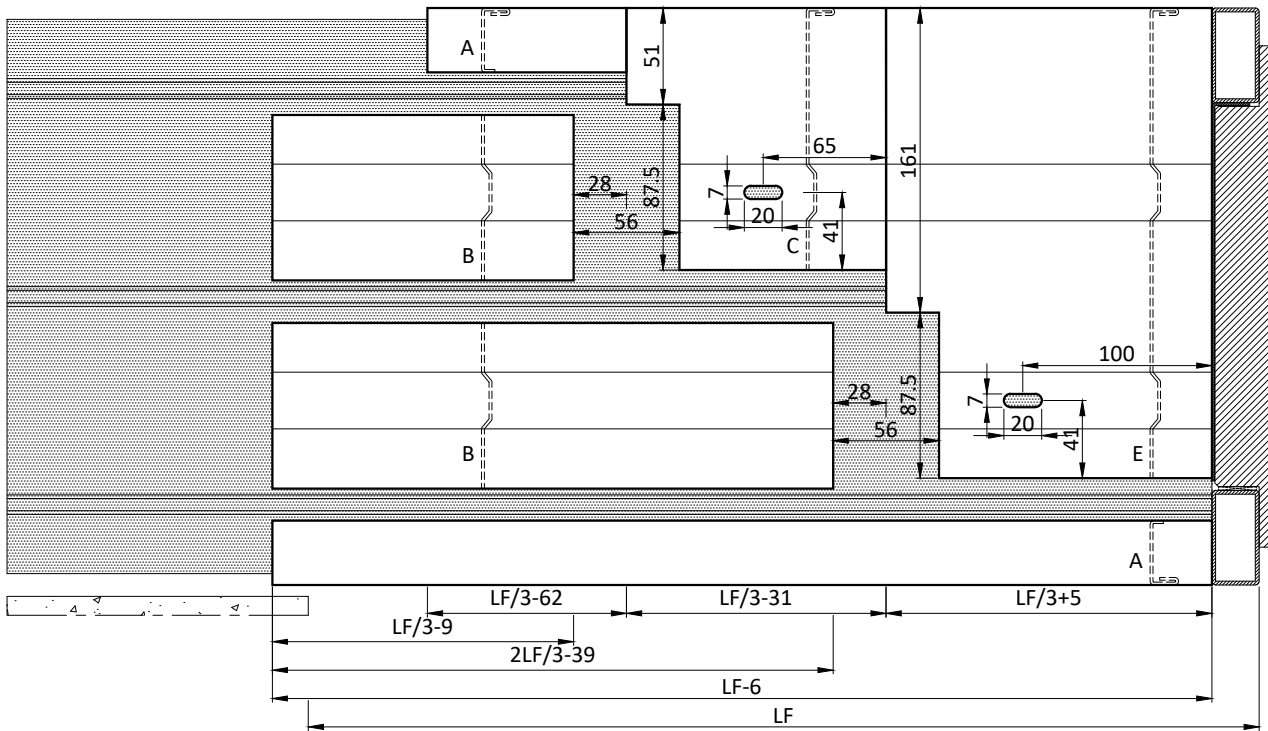
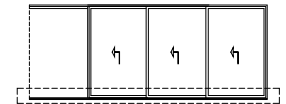

PR2981.1

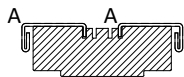

Schema | Type T1

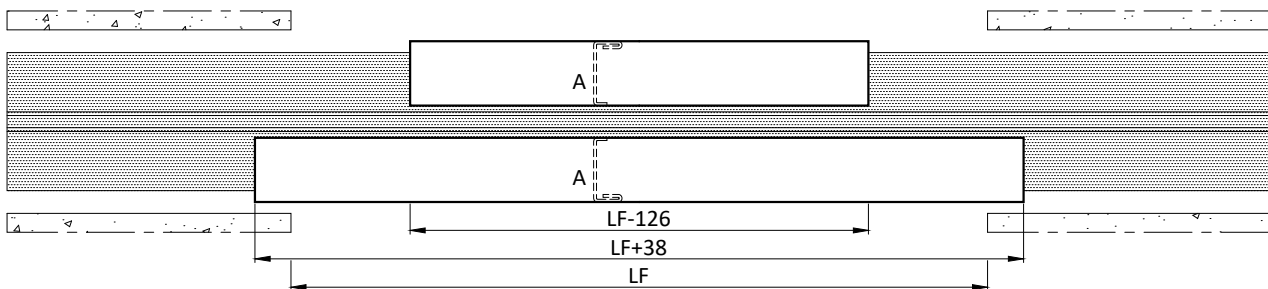
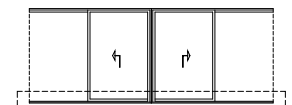

Le copertine in metallo devono essere fissate al profilo estruso PR2981.3-PR2981.1 mediante incollaggio con silicone  
 The metal covers have to be attached to the extrusion profile PR2981.3-PR2981.1 with silicon  
 La copertina A interna va posizionata dopo il fissaggio del serramento a terra  
 Internal cover A must be put in place once the window/door has been attached on the ground

PR2981.2

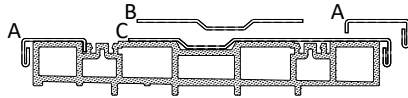

Schema | Type T2

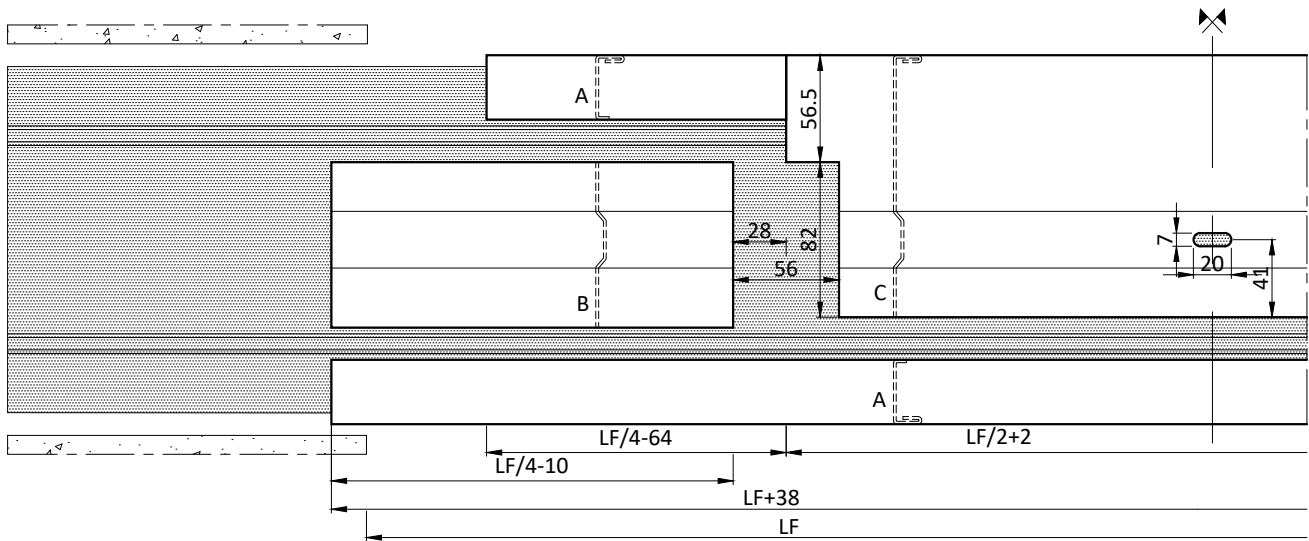
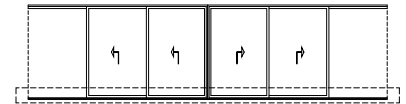

PR2981.3

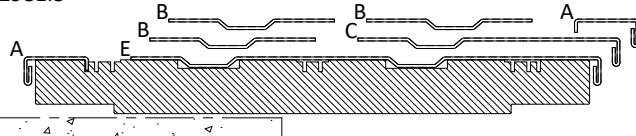

Schema | Type T3

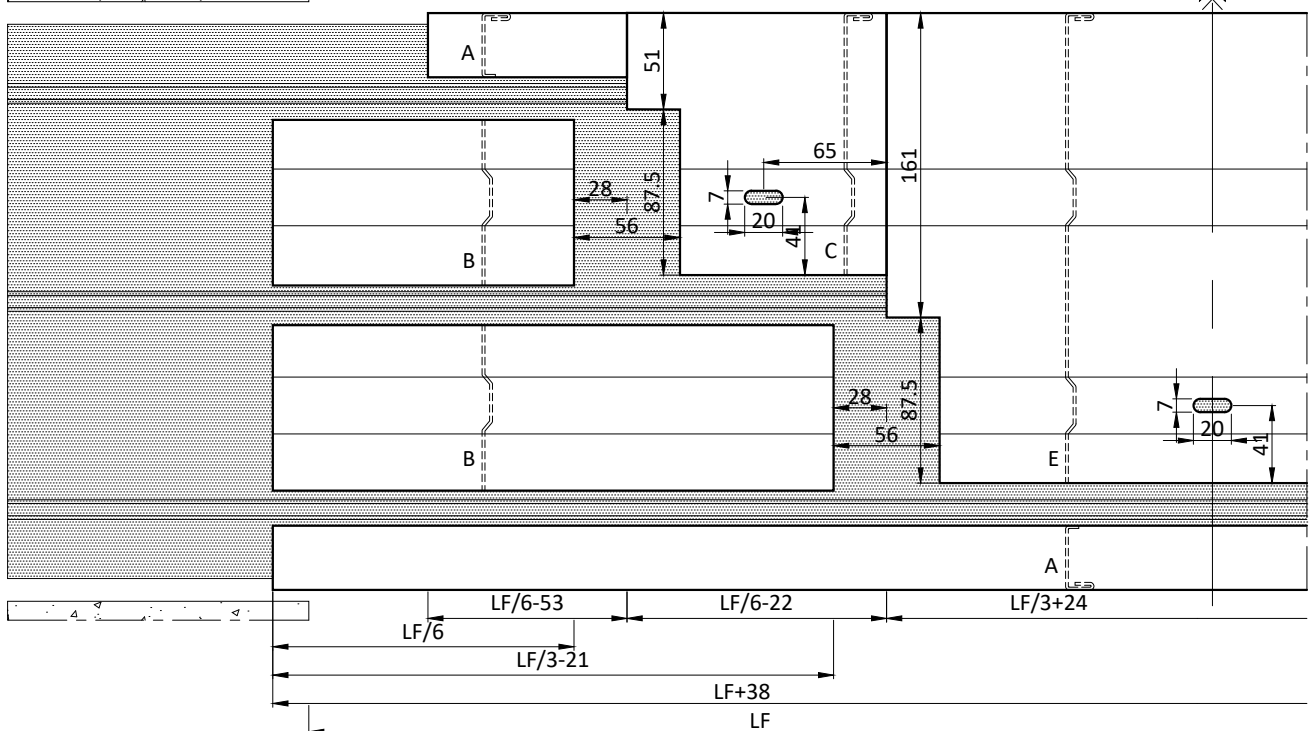
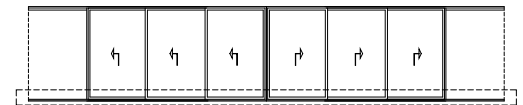

Le copertine in metallo devono essere fissate al profilo estruso PR2981.2-PR2981.3 mediante incollaggio con silicone  
 The metal covers have to be attached to the extrusion profile PR2981.2-PR2981.3 with silicon  
 La copertina A interna va posizionata dopo il fissaggio del serramento a terra  
 Internal cover A must be put in place once the window/door has been attached on the ground

Schema | Type S2-T2

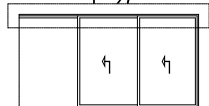

Schema | Type E-F

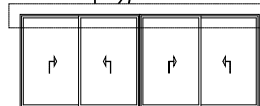

Schema | Type C

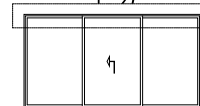

Schema | Type A-B

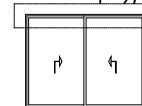

Schema | Type S3-T3

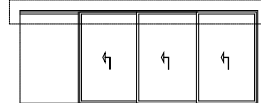

Schema | Type E3-F3

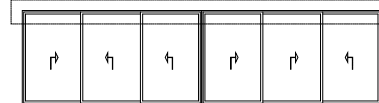

Schema | Type A3-B3-C3

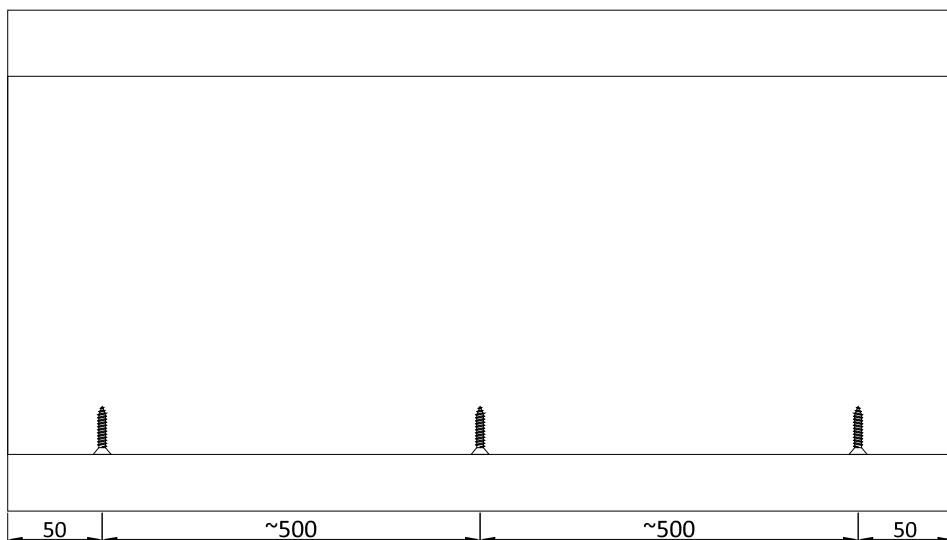
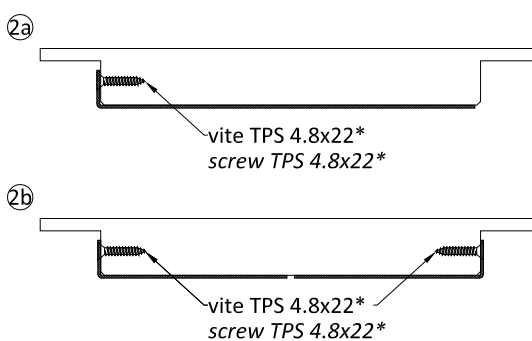
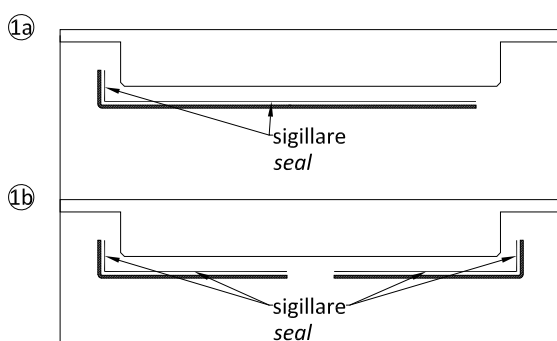
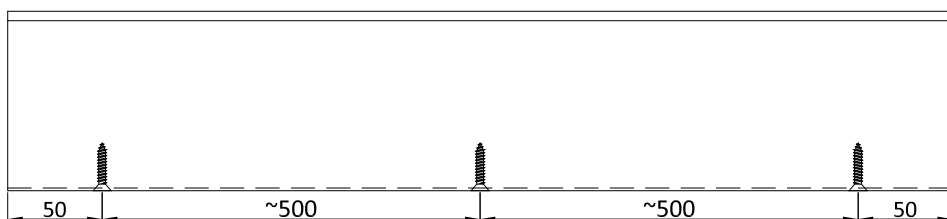
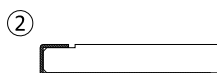
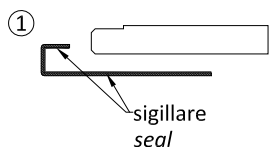
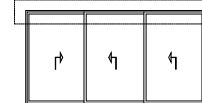

\* viti TPS 4.8x22 non comprese  
\* screws TPS 4.8x22 not supplied



Schema | Type S2

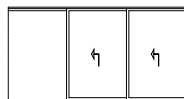

Schema | Type C

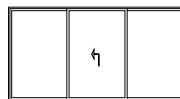

Schema | Type B

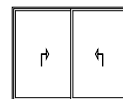

Schema | Type A



Schema | Type T2

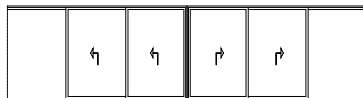

Schema | Type F

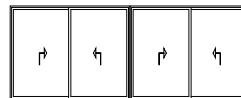

Schema | Type E

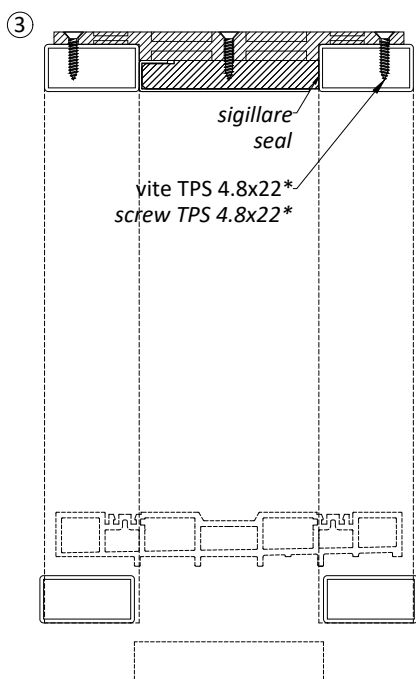
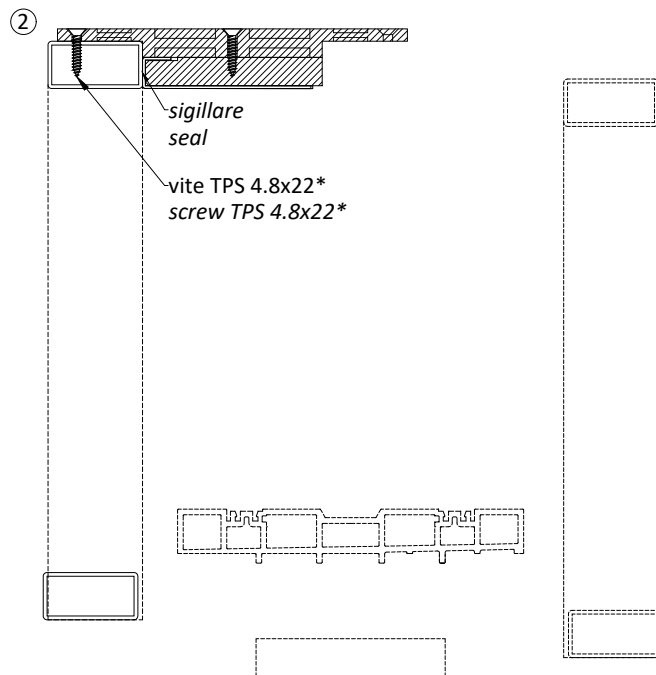
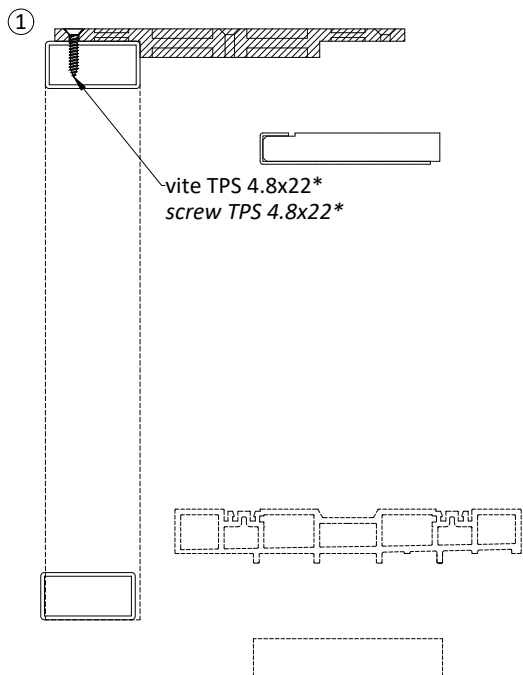
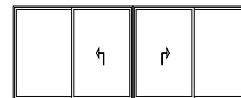

sigillare tutte le cavità  
nelle due estremità  
seal all cavities at the two  
extremes

vite TC 4.8x22\*  
screw TPS 4.8x22\*

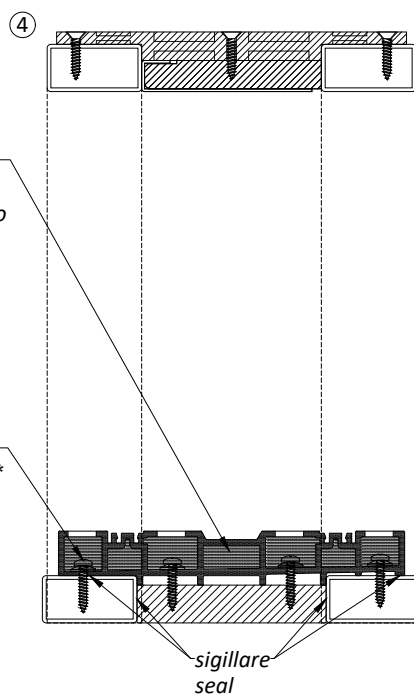

\* viti TPS-TC 4.8x22 non comprese  
\* screws TPS-TC 4.8x22 not supplied

Schema | Type S3

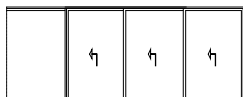

Schema | Type C3

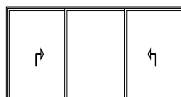

Schema | Type B3

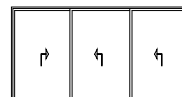

Schema | Type A3

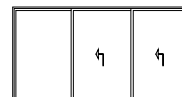

Schema | Type S3

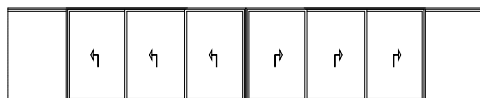

Schema | Type F3

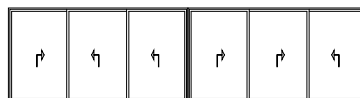

Schema | Type E3

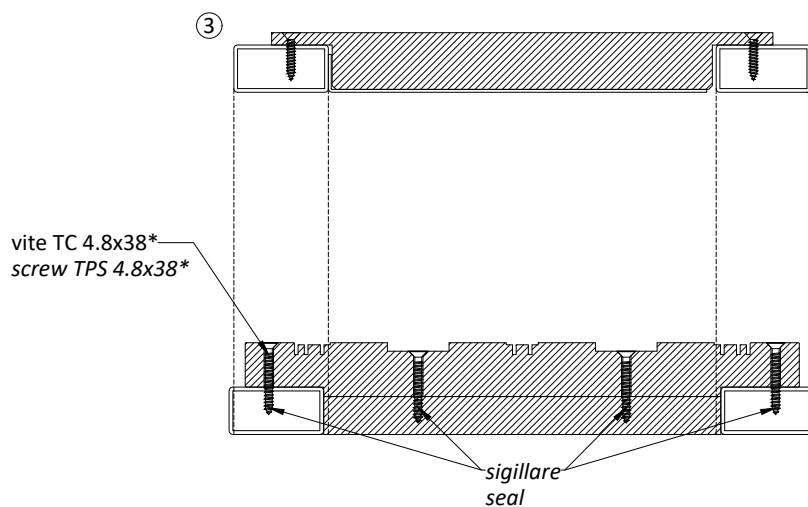
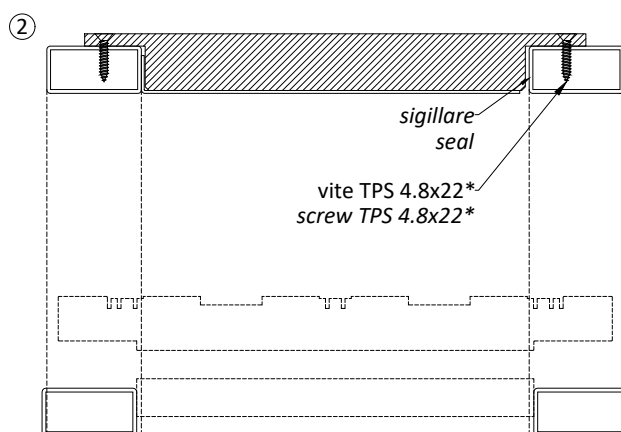
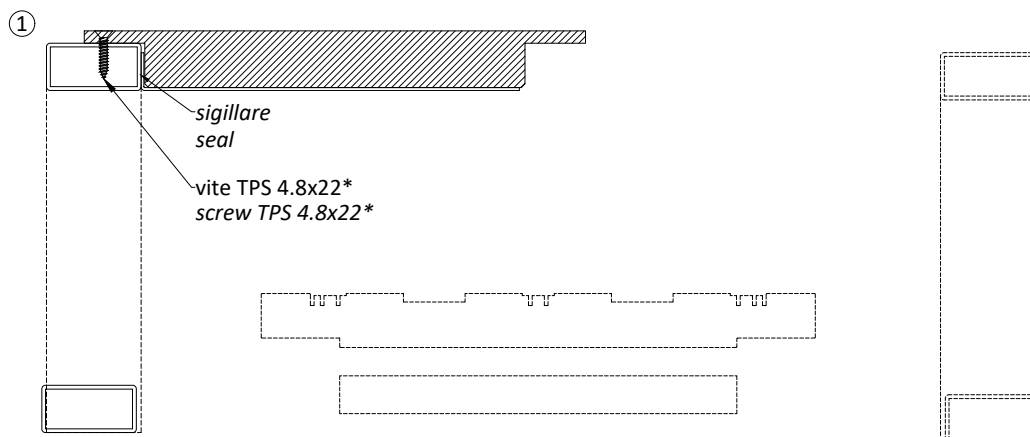
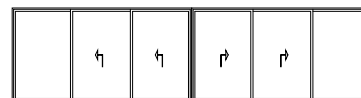

\* viti TPS 4.8x22-38 non comprese  
\* screws TPS 4.8x22-38 not supplied

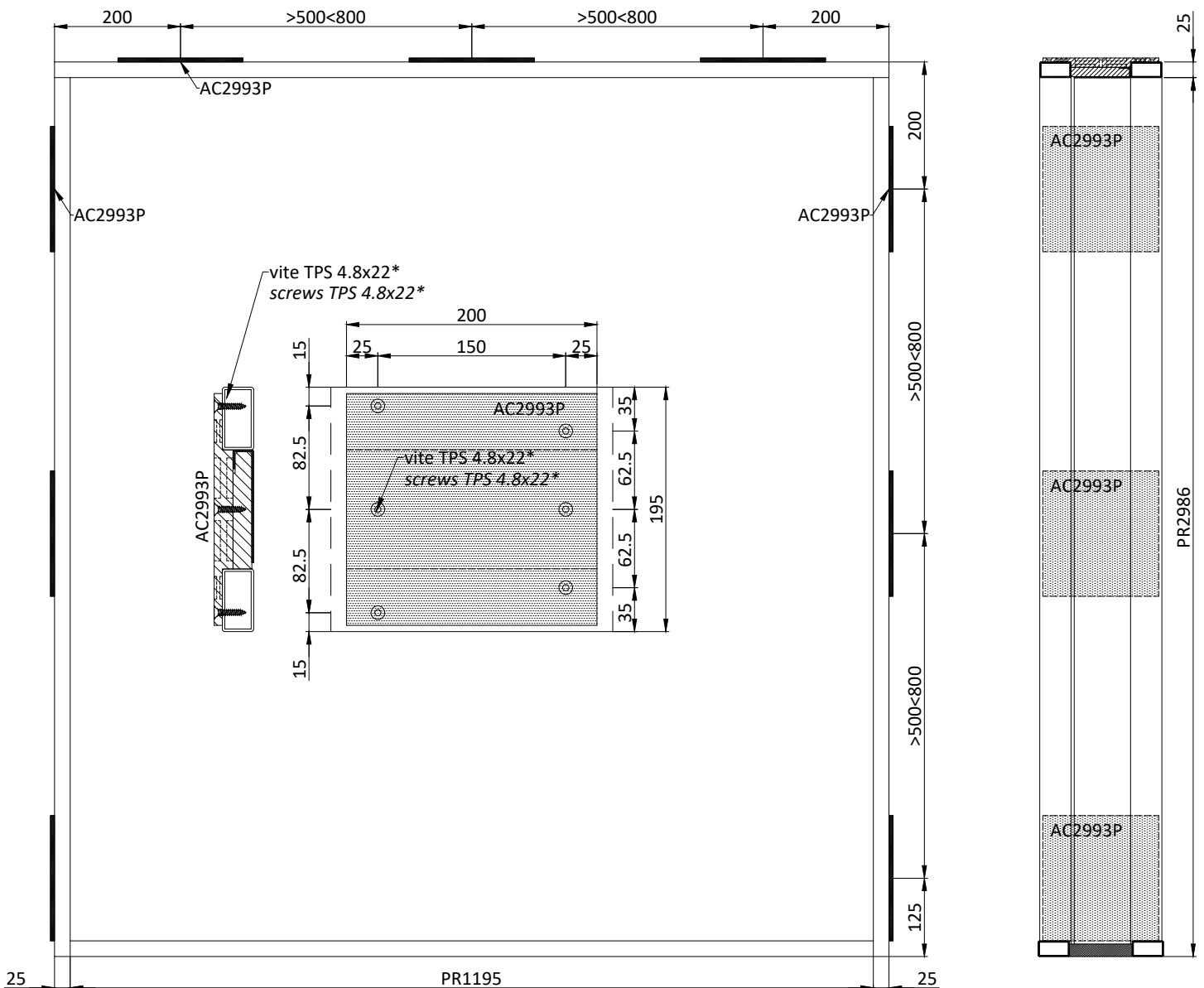
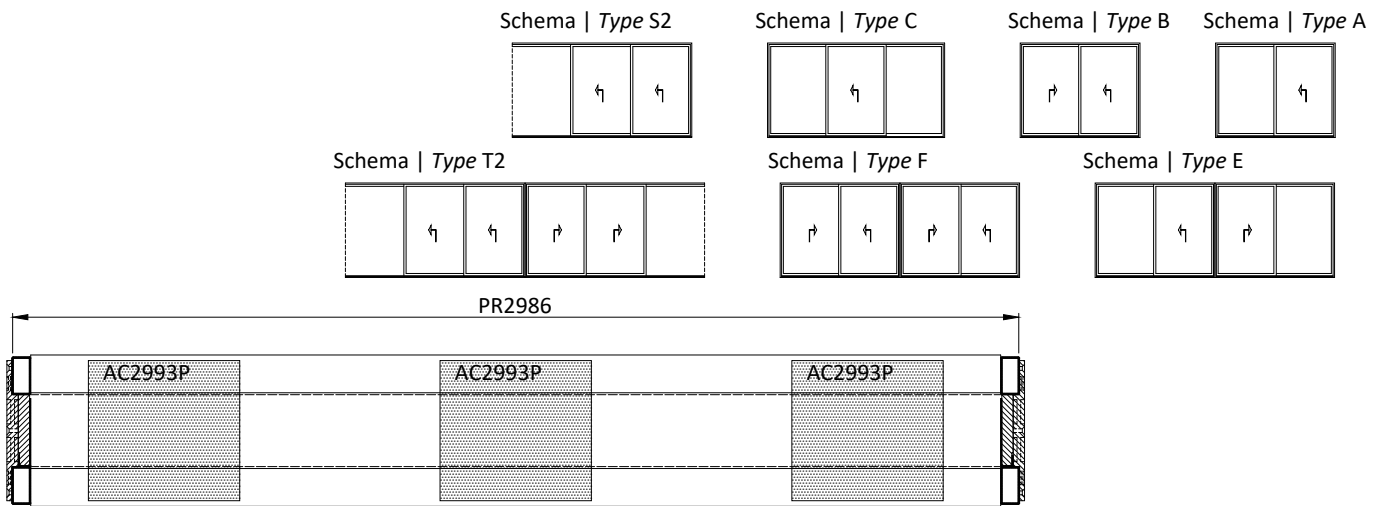

\* viti TPS 4.8x22 non comprese  
\* screws TPS 4.8x22 not supplied

Schema | Type S3

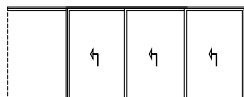

Schema | Type C3

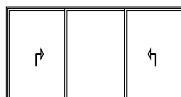

Schema | Type B3

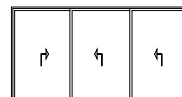

Schema | Type A3

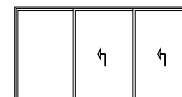

Schema | Type T3

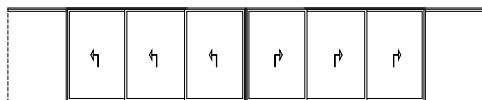

Schema | Type F3

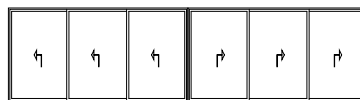

Schema | Type E3

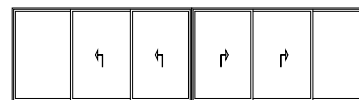

PR2986.3-PR2986S3

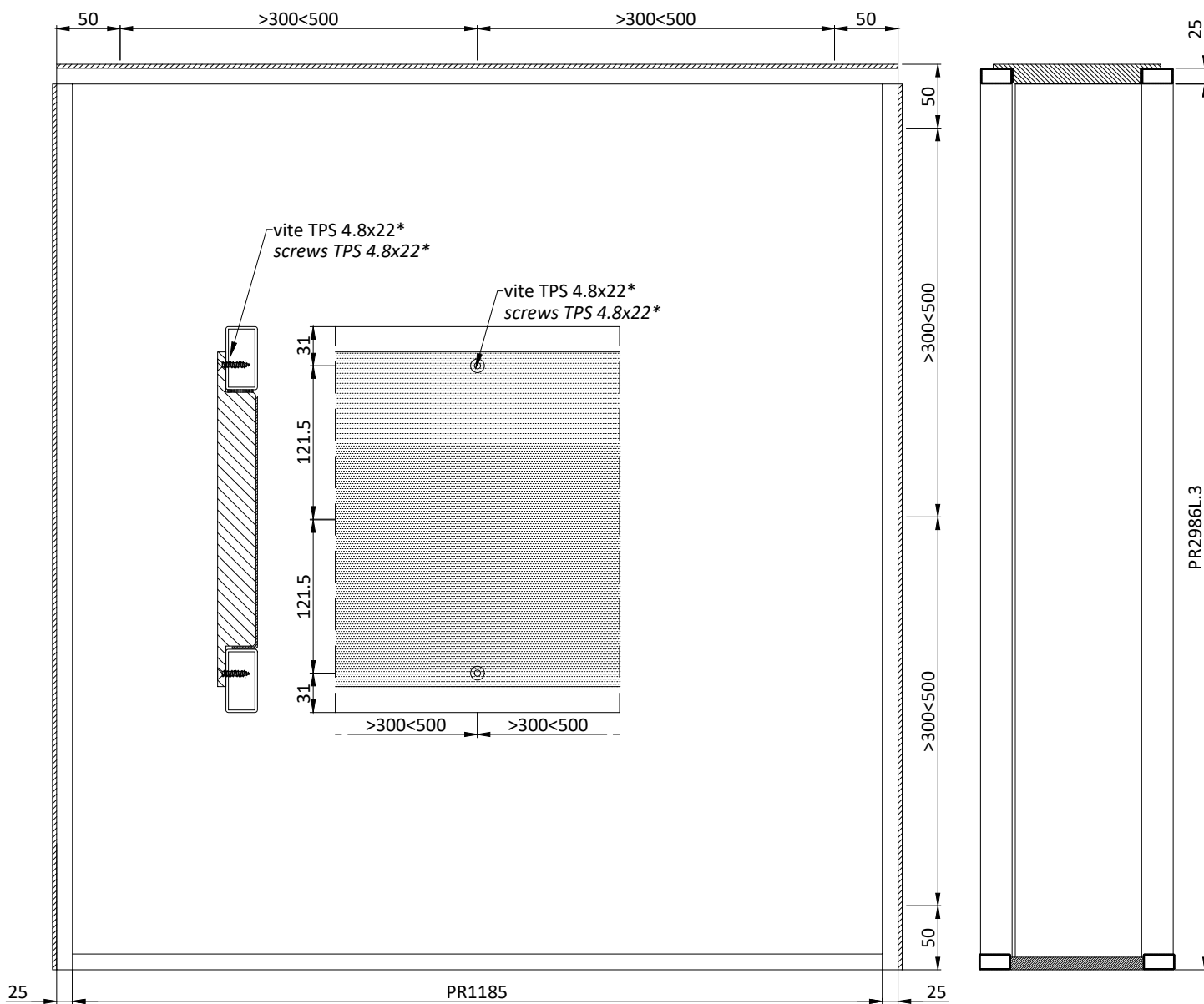
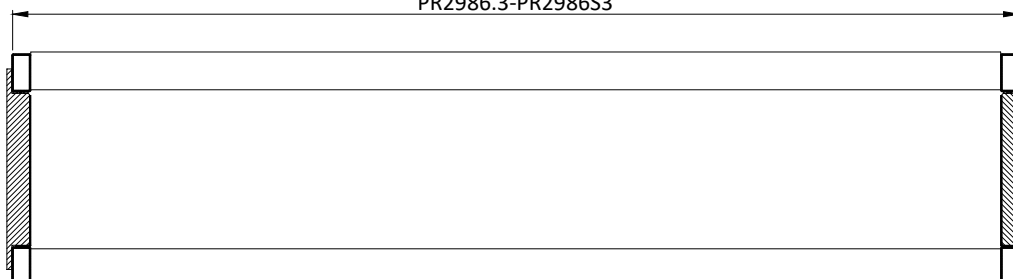

\* viti TPS 4.8x22 non comprese  
\* screws TPS 4.8x22 not supplied

Schema | Type A

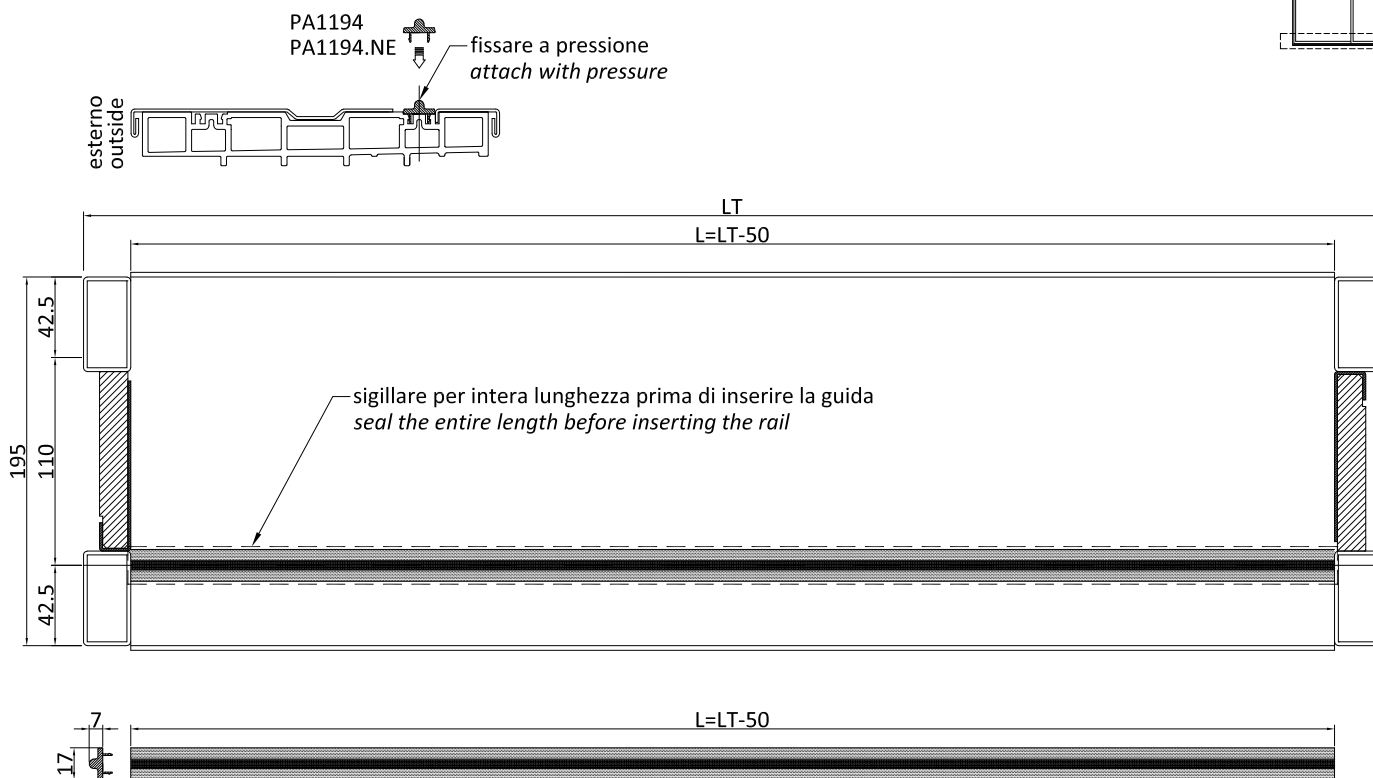
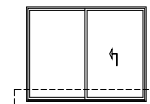

Schema | Type B

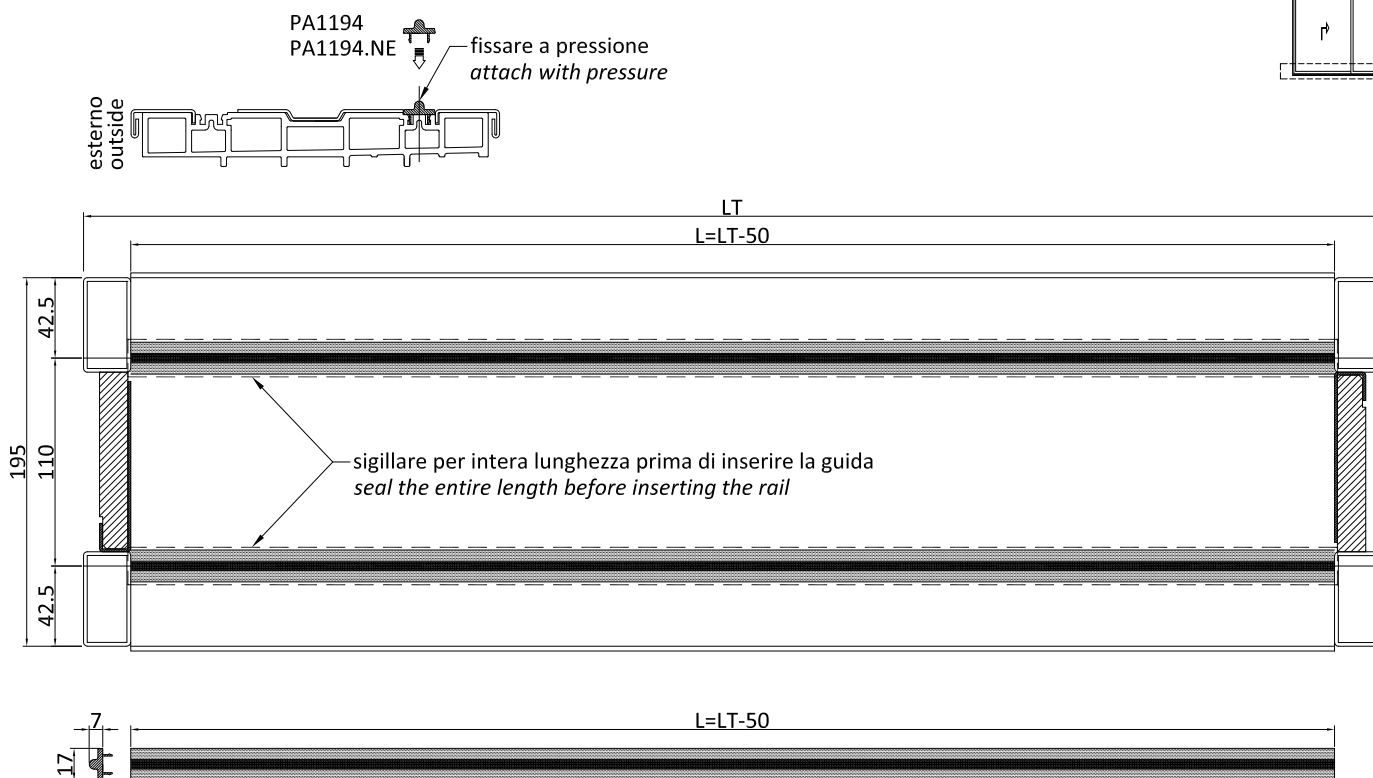
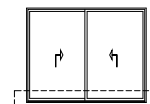

Schema | Type C

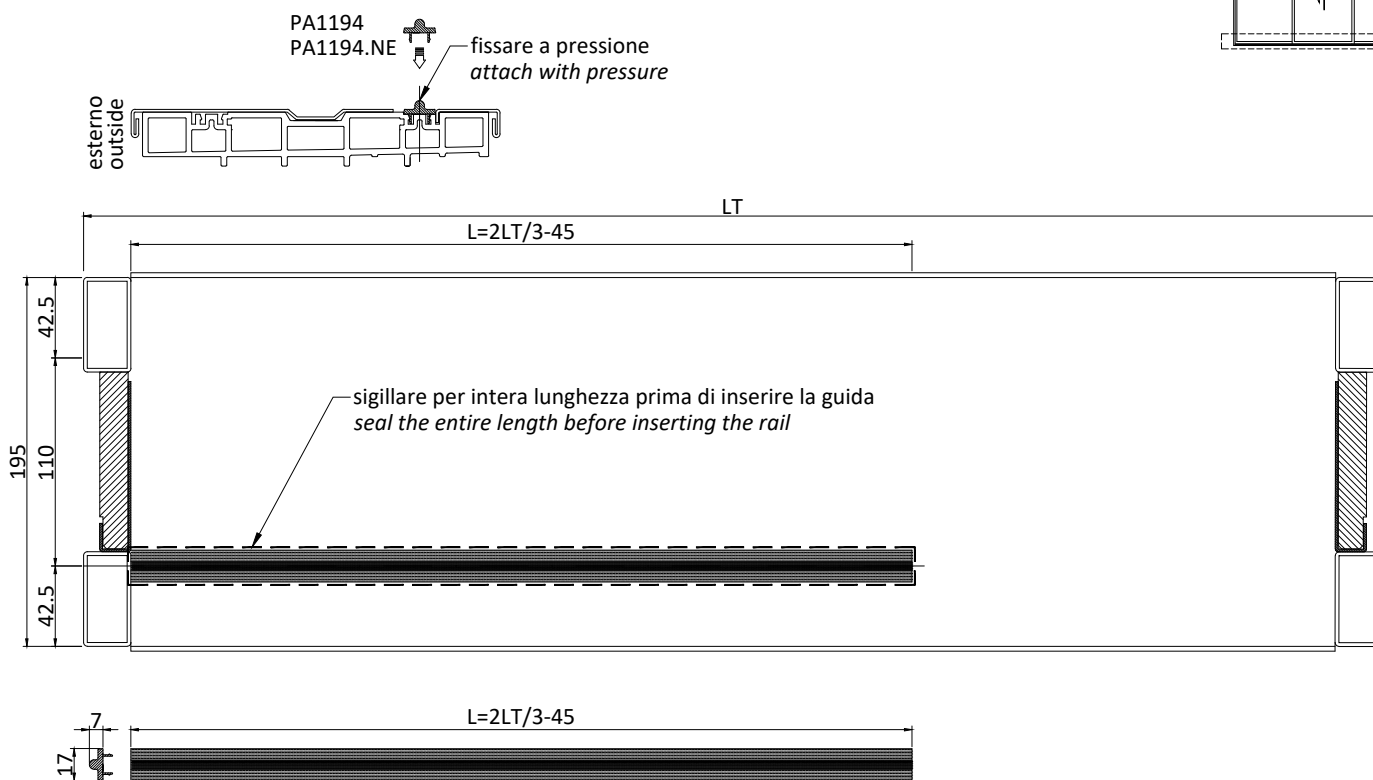
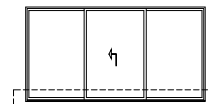

Schema | Type E

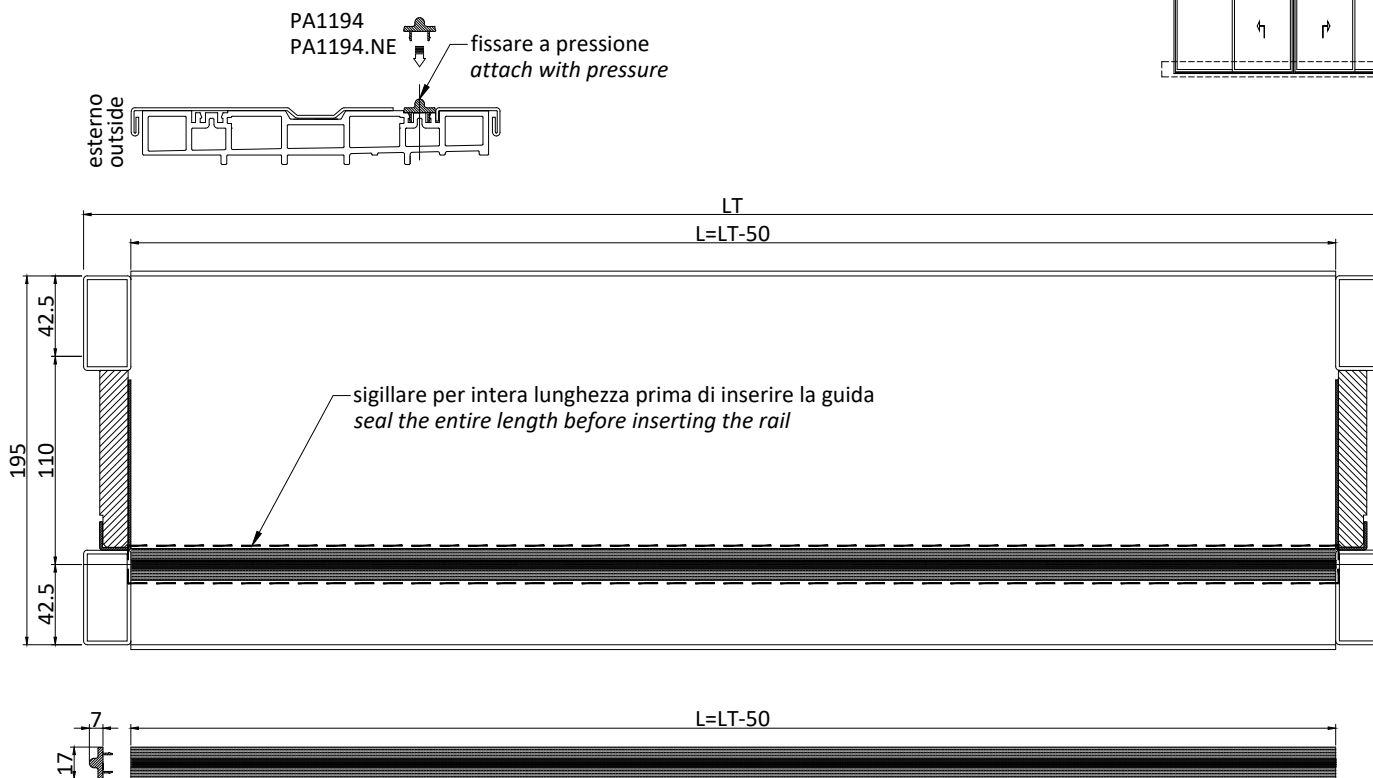
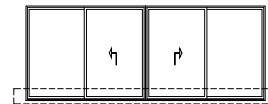

Schema | Type F

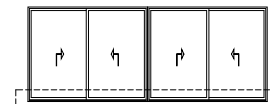

PA1194  
PA1194.NE

fissare a pressione  
attach with pressure

esterno  
outside

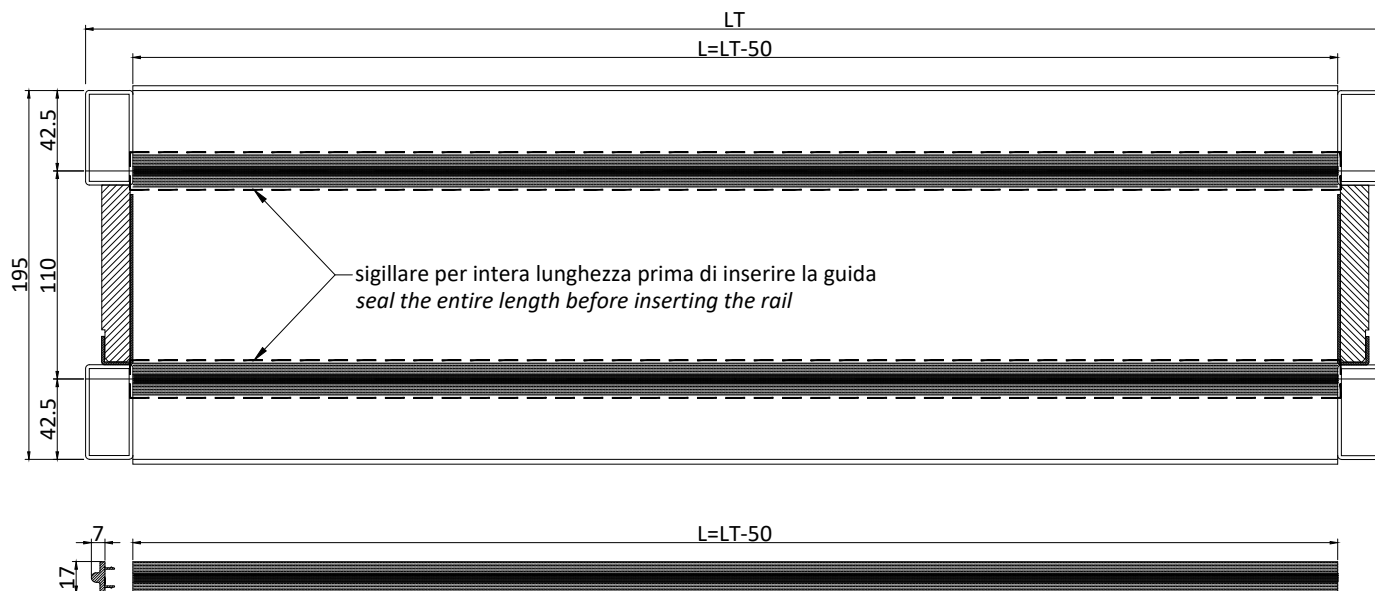

Schema | Type A3

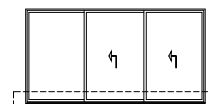

PA1194  
PA1194.NE

fissare a pressione  
attach with pressure

esterno  
outside

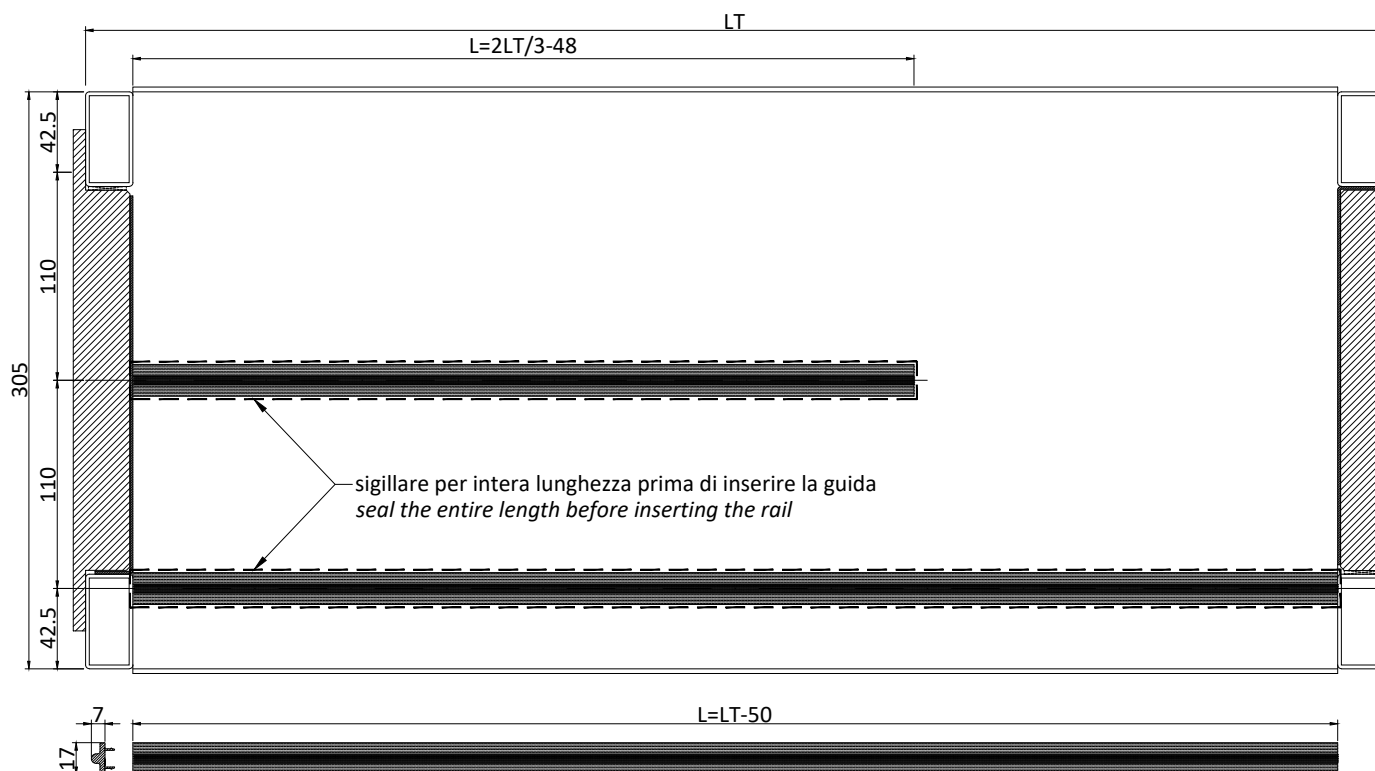

PA1194  
 PA1194.NE

fissare a pressione  
 attach with pressure

Schema | Type B3

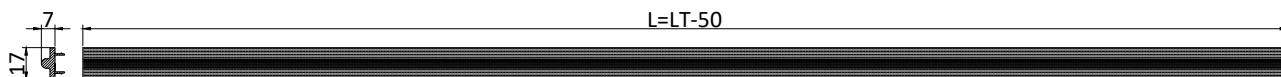
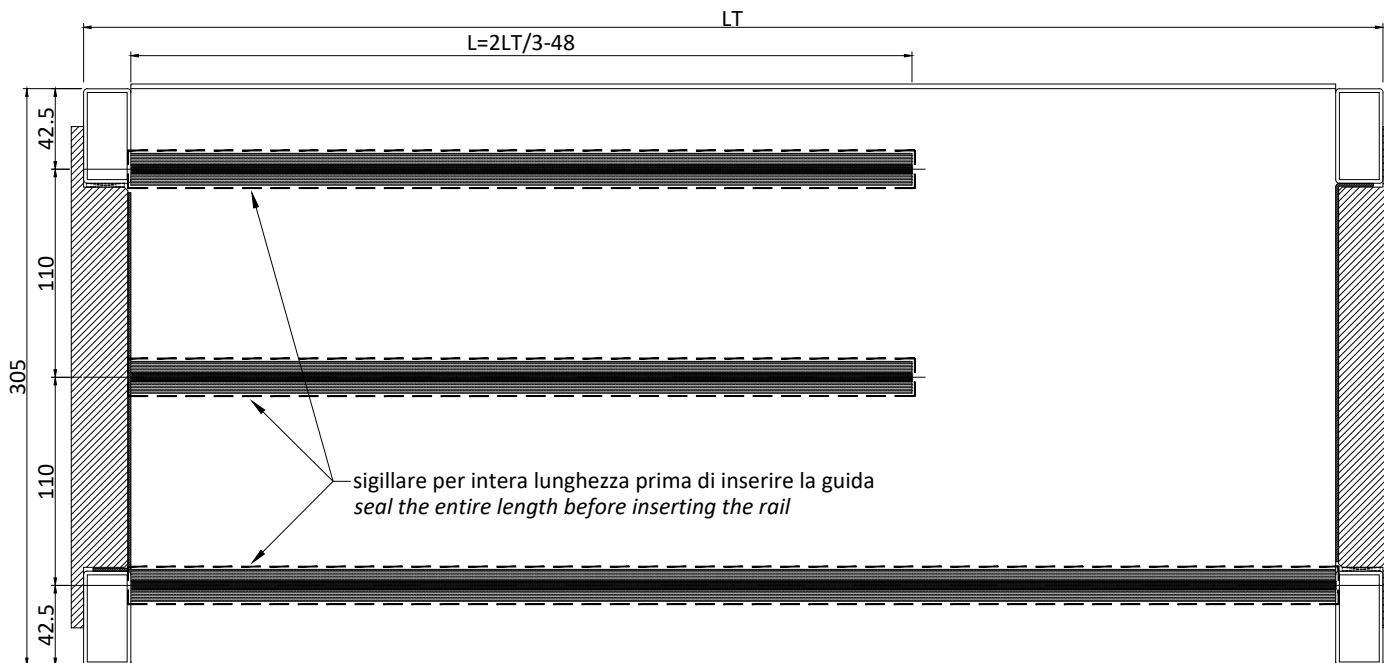

PA1194  
 PA1194.NE

fissare a pressione  
 attach with pressure

Schema | Type C3

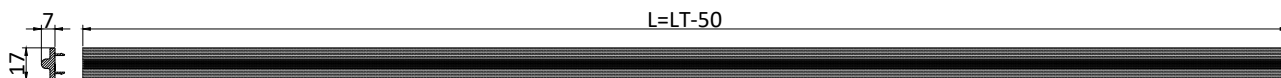
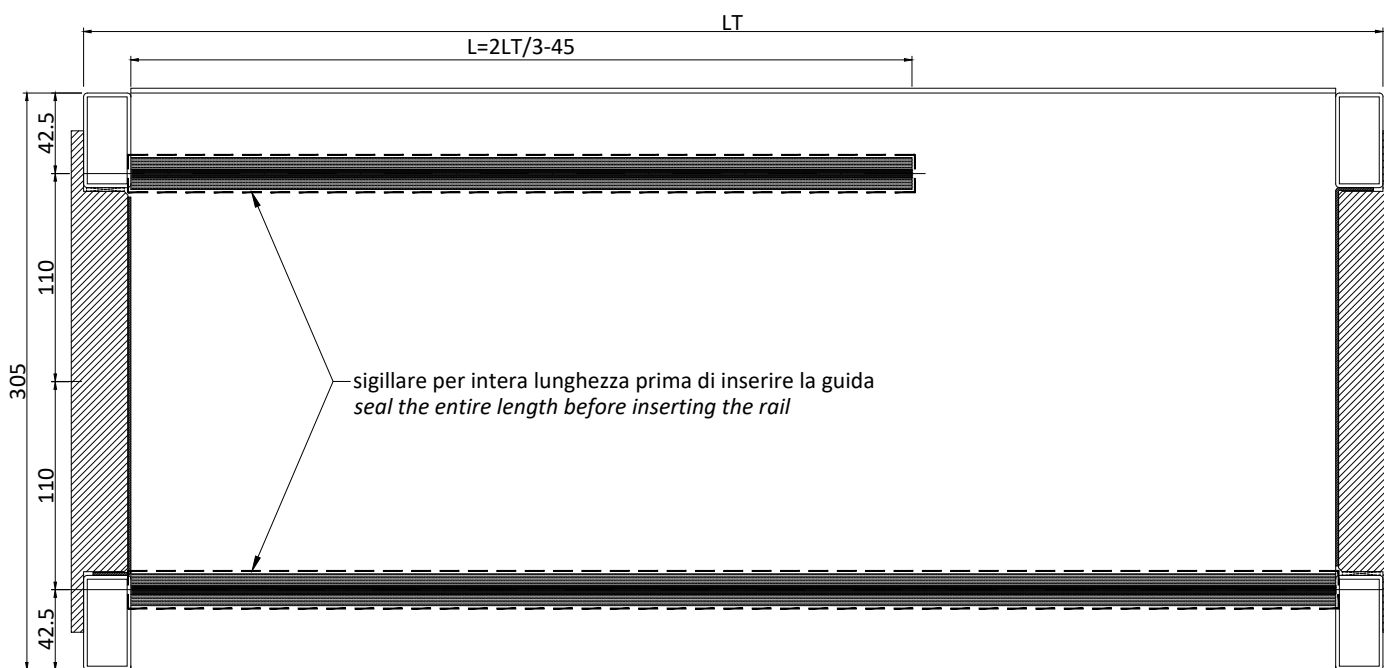
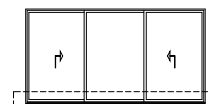



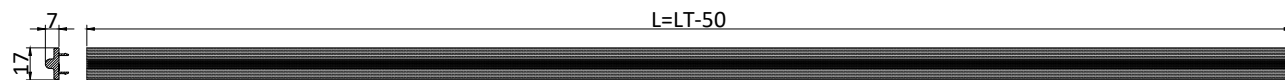
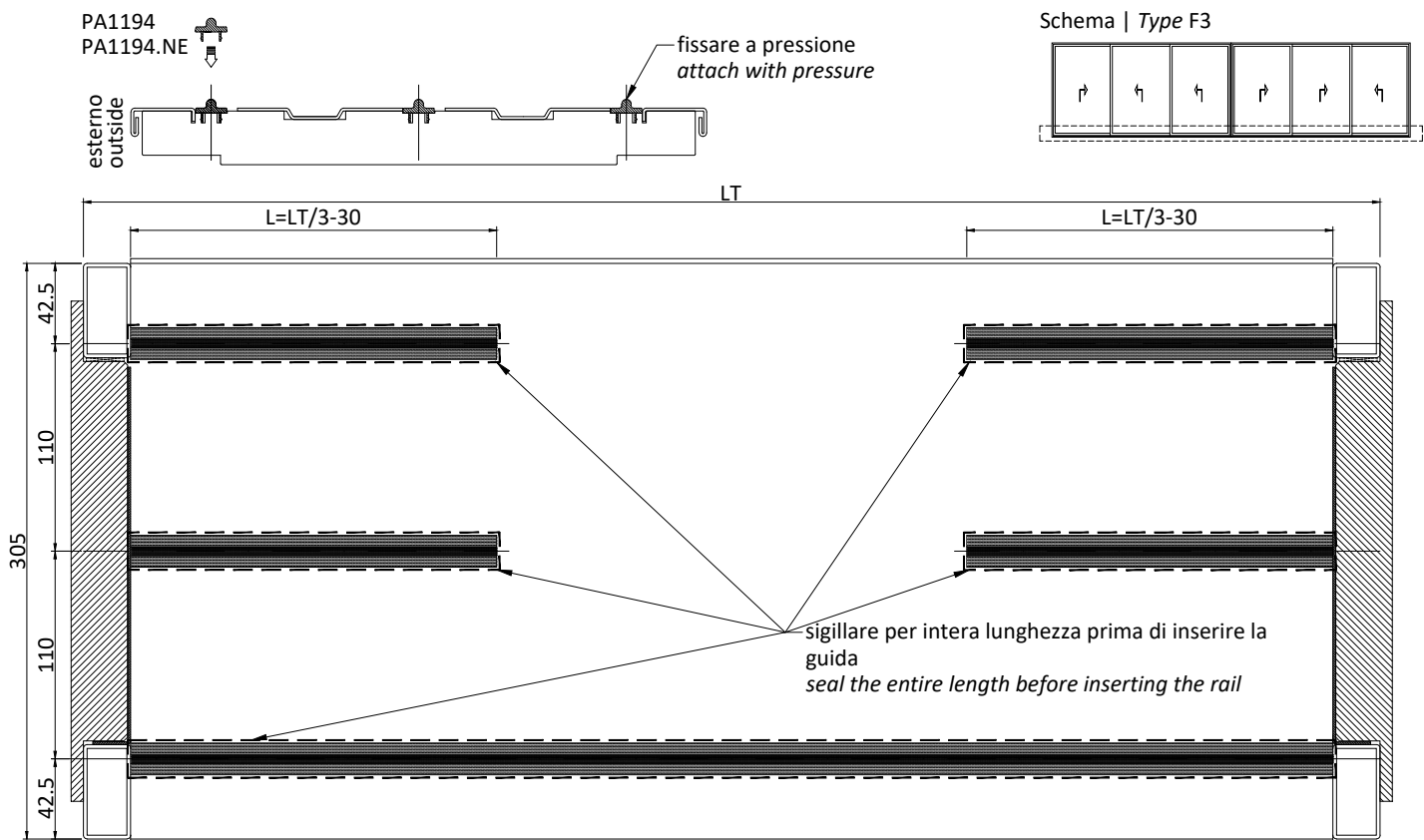
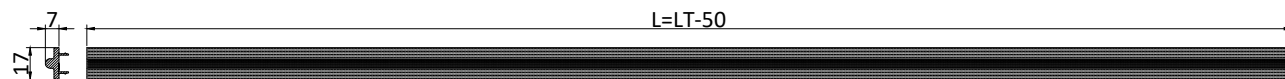
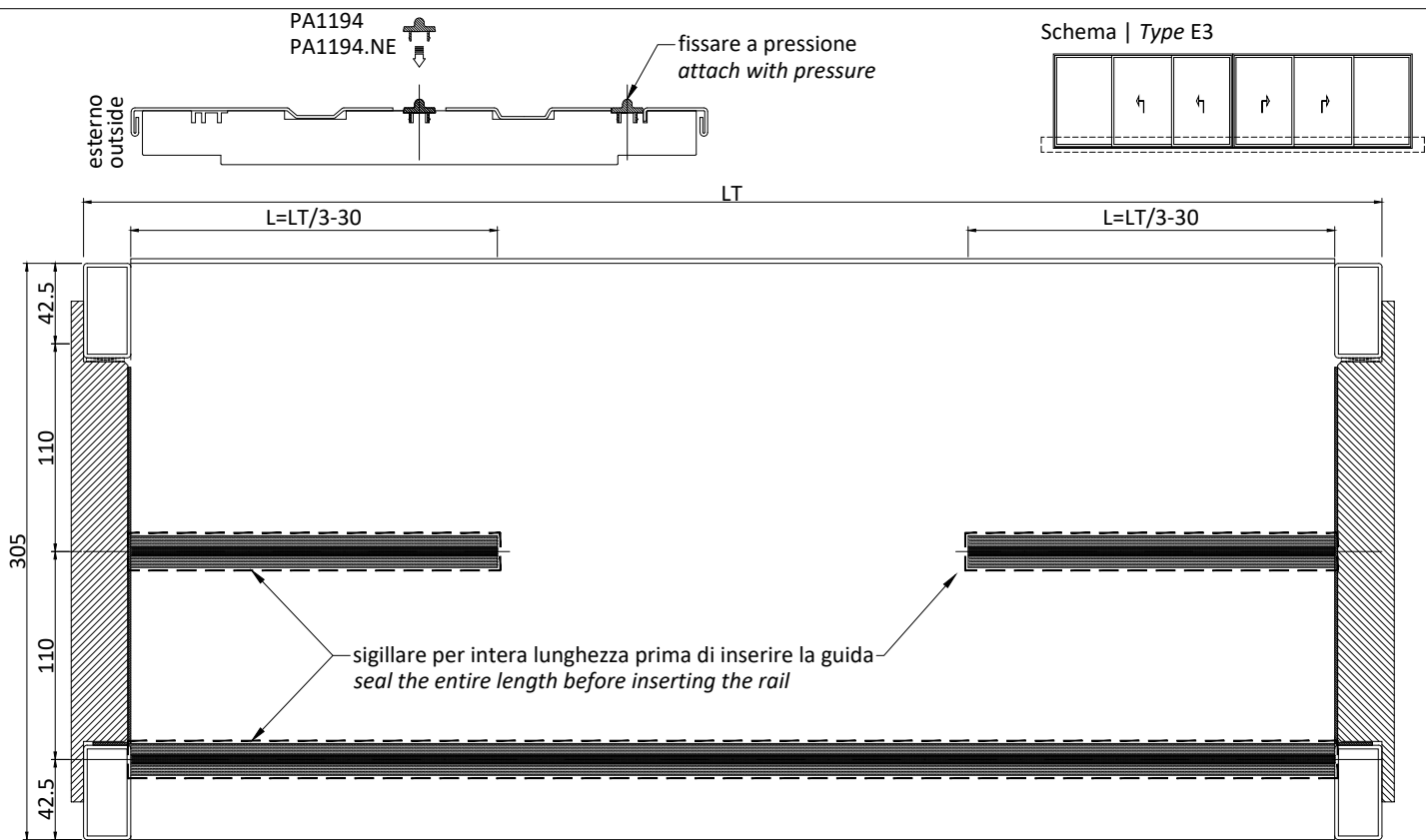

Schema | Type S1

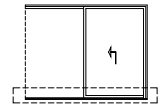

PA1194  
 PA1194.NE

fissare a pressione  
 attach with pressure

esterno  
 outside

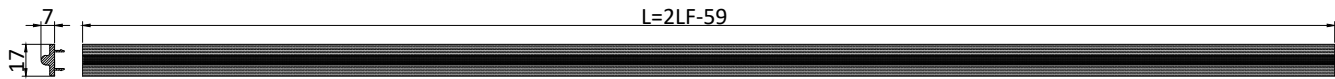
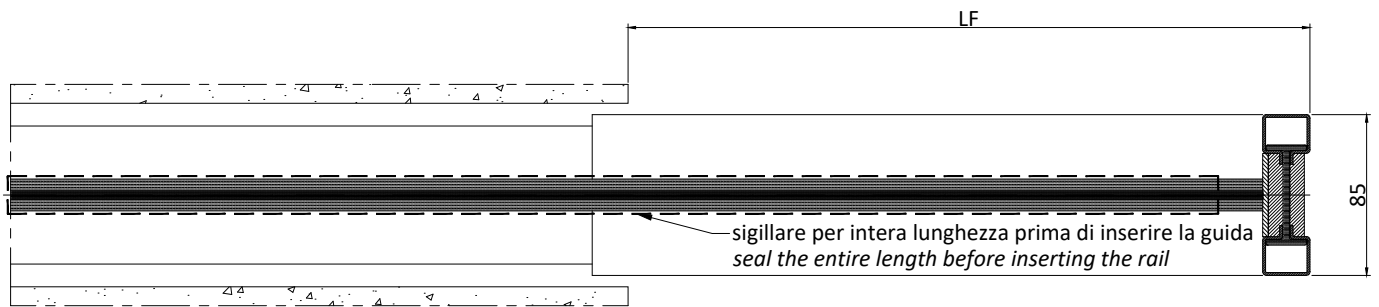
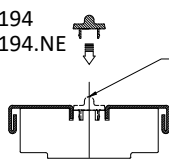

Schema | Type S2

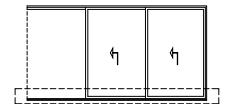

PA1194  
 PA1194.NE

fissare a pressione  
 attach with pressure

esterno  
 outside

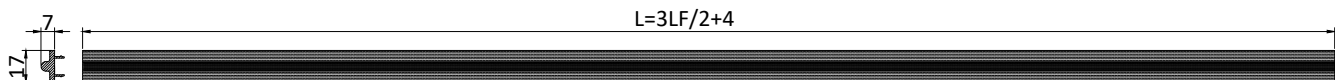
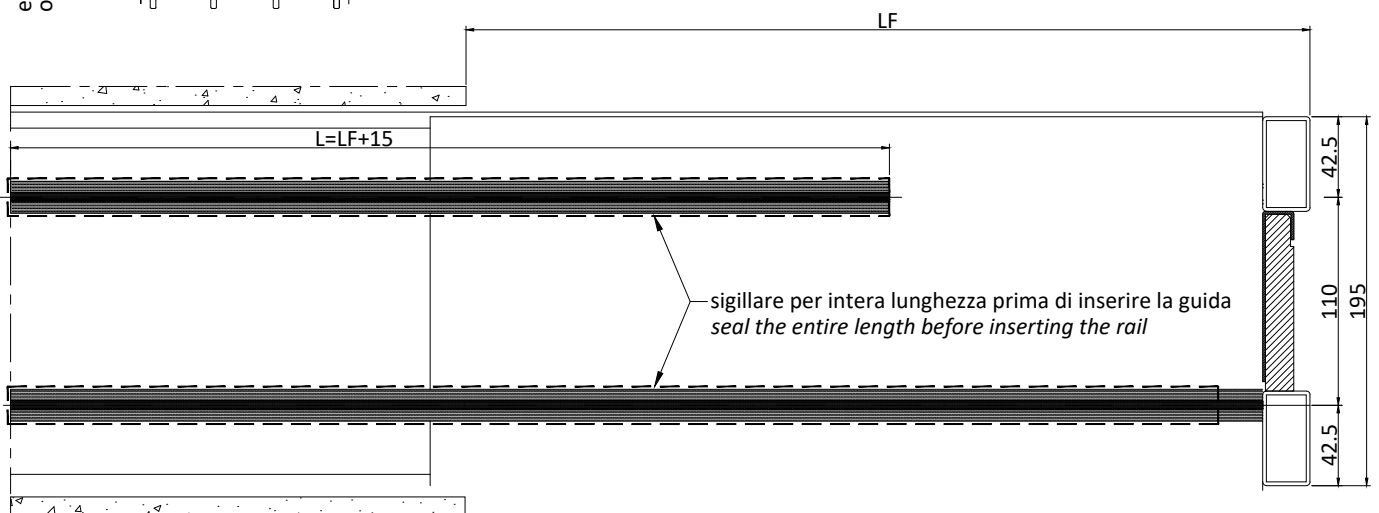
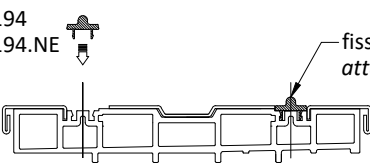

PA1194  
 PA1194.NE



fissare a pressione  
 attach with pressure

Schema | Type S3

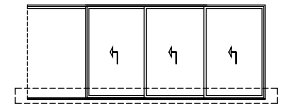

esterno  
 outside

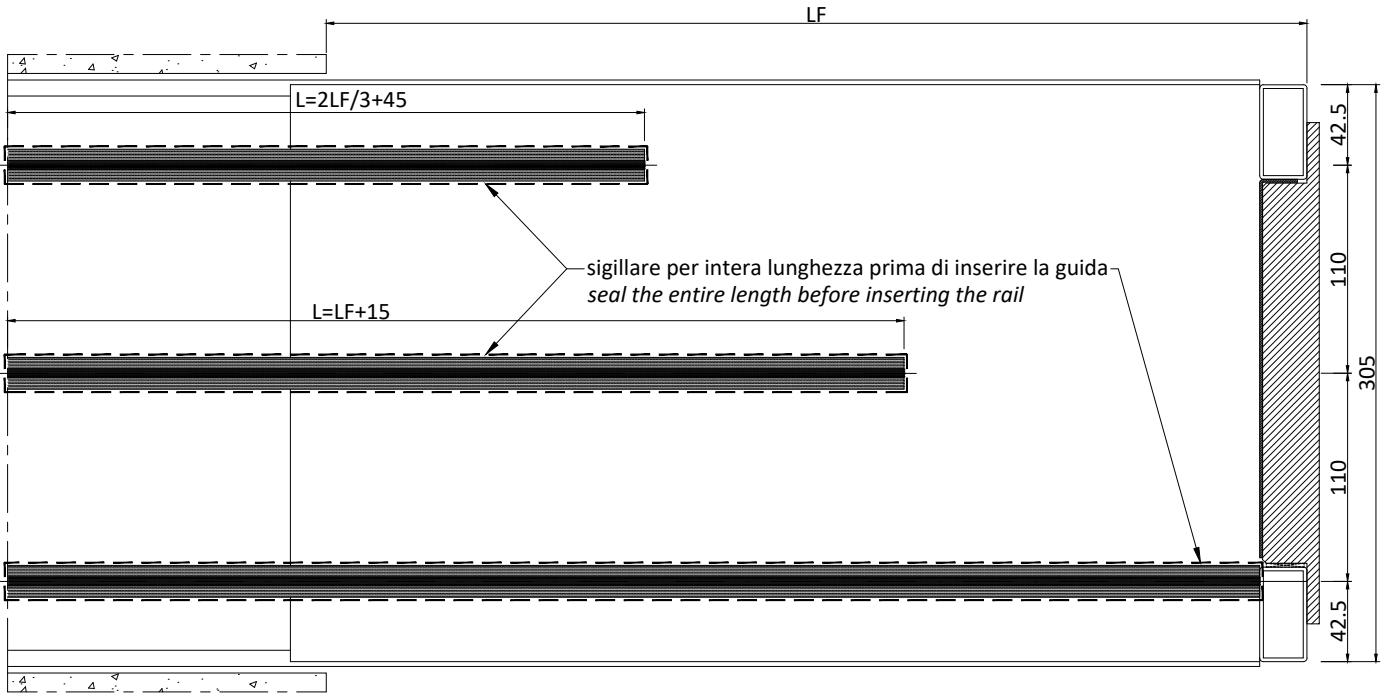

$L=4LF/3+19$

Schema | Type T1

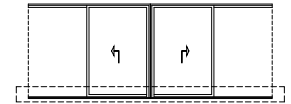

PA1194  
 PA1194.NE



fissare a pressione  
 attach with pressure

esterno  
 outside

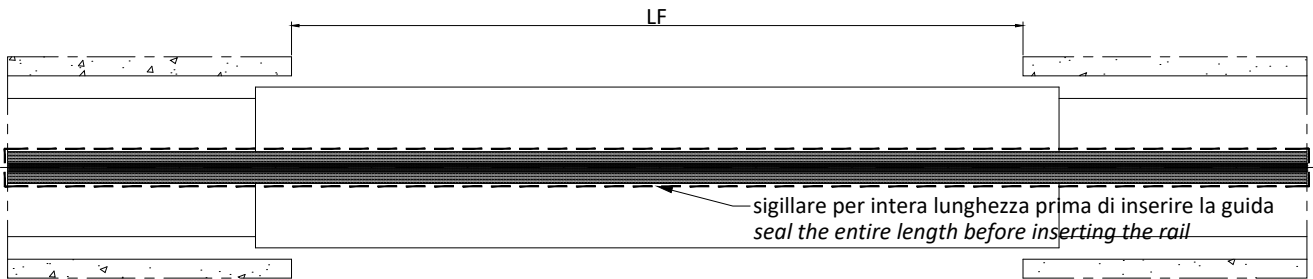

$L=2LF-14$

Schema | Type T2

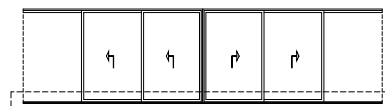

PA1194  
PA1194.NE



fissare a pressione  
attach with pressure

esterno  
outside

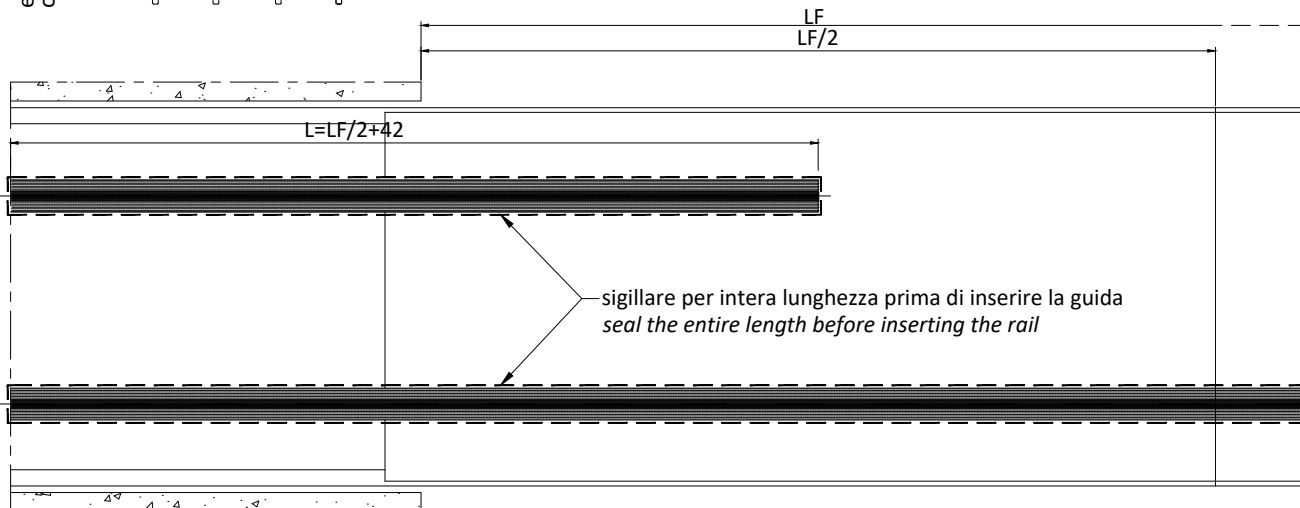

$L=3LF/2+86$

Schema | Type T3

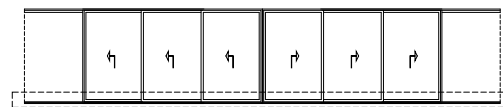

PA1194  
PA1194.NE



fissare a pressione  
attach with pressure

esterno  
outside

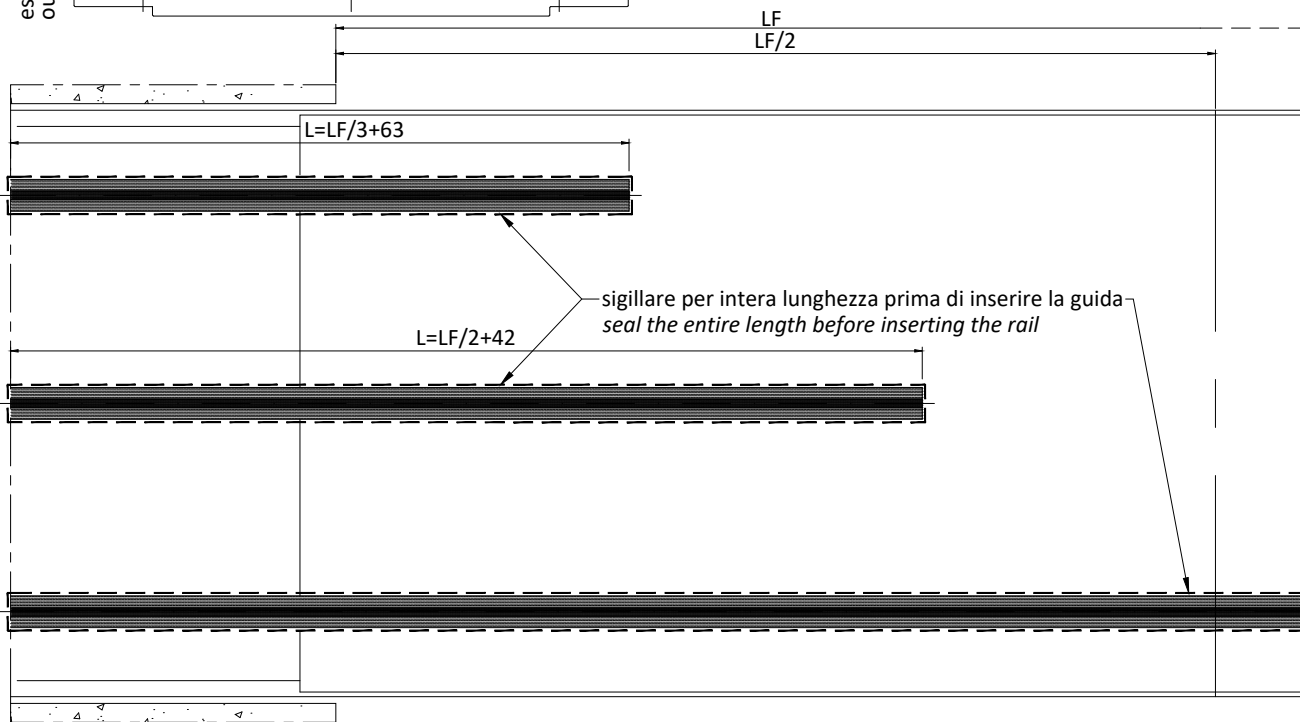

$L=4LF/3+107$



Schema | Type T2

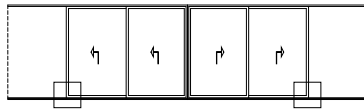

Schema | Type S2

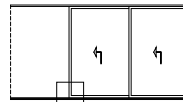

Schema | Type T1

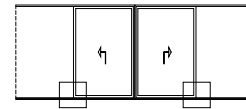

Schema | Type S1

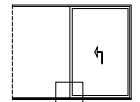

Schema | Type T3

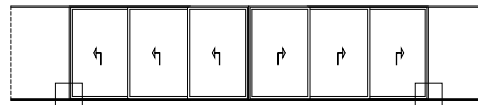

Schema | Type S3

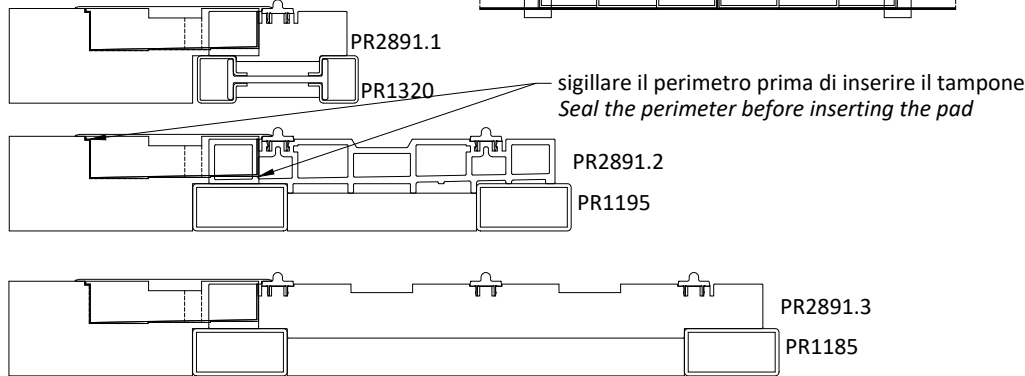
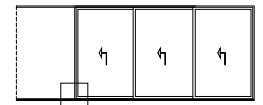

sigillare completamente sotto al montante fisso  
seal completely under the fix mullion

lavorazione su tooling on  
PR2891.1  
PR2981.2  
PR2981.3

vaschetta porta tampone  
pad case

svasatura countersunk  
Ø12

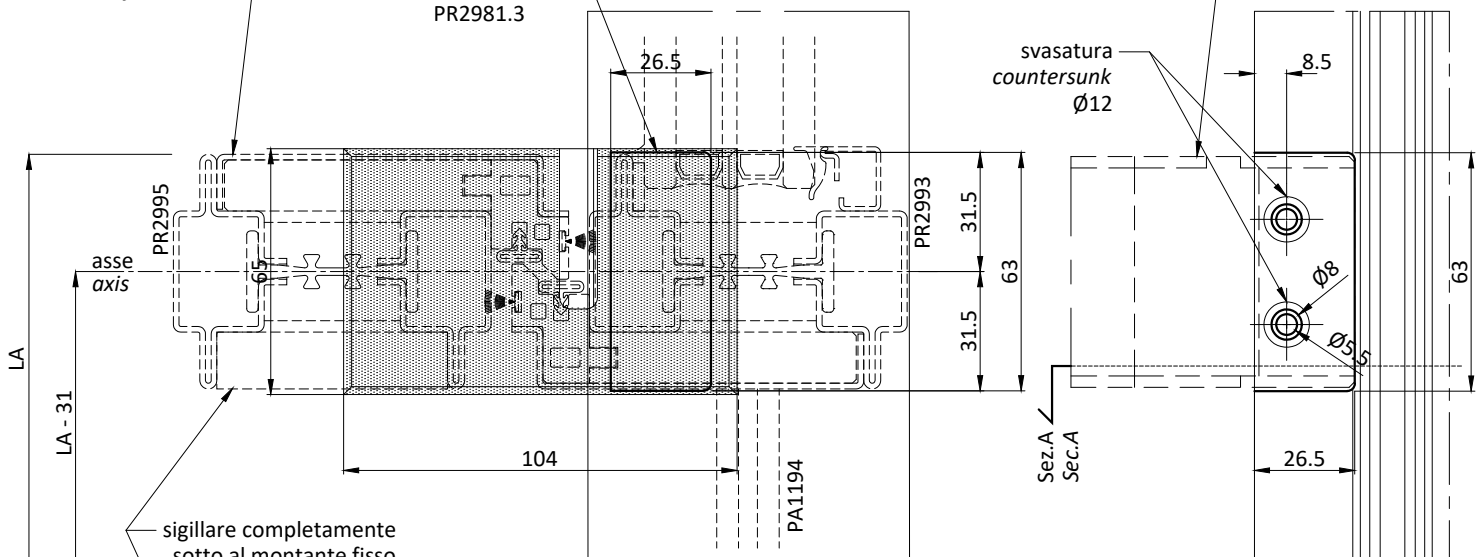

sigillare completamente sotto al montante fisso  
seal completely under the fix mullion

\*viti TPS 5,5  
screws TPS 5,5

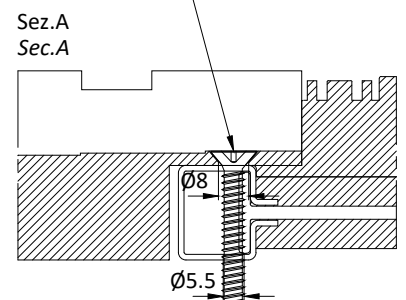

\*viti non comprese | screws not supplied

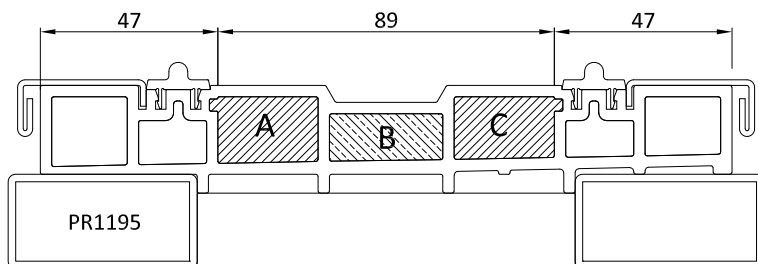
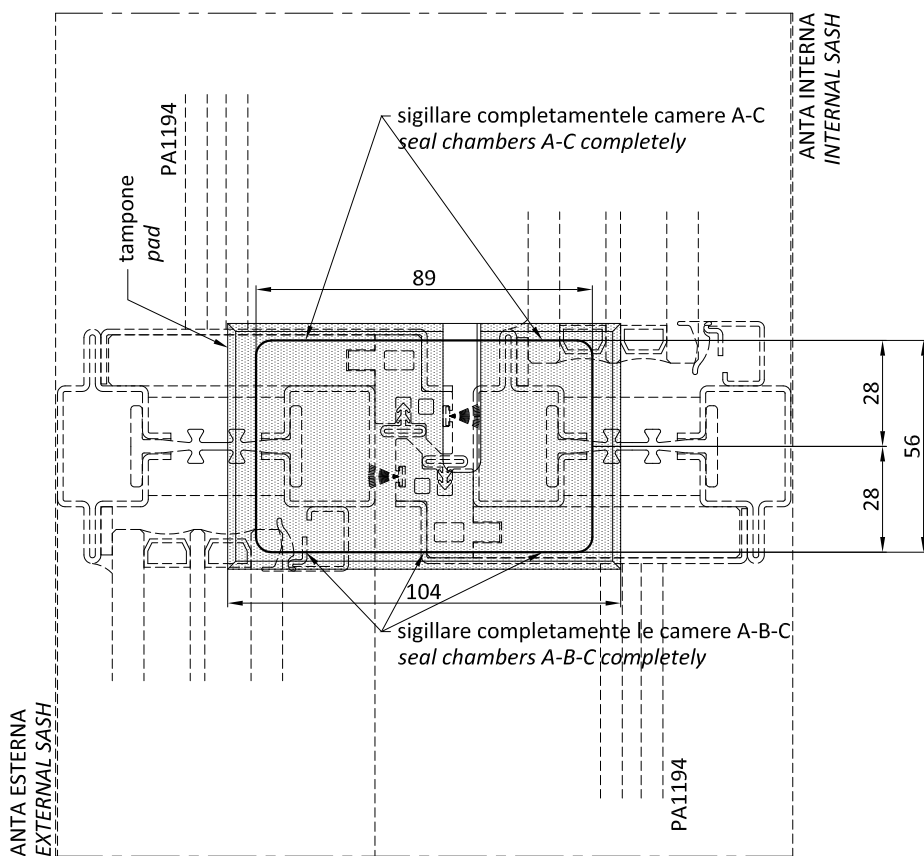
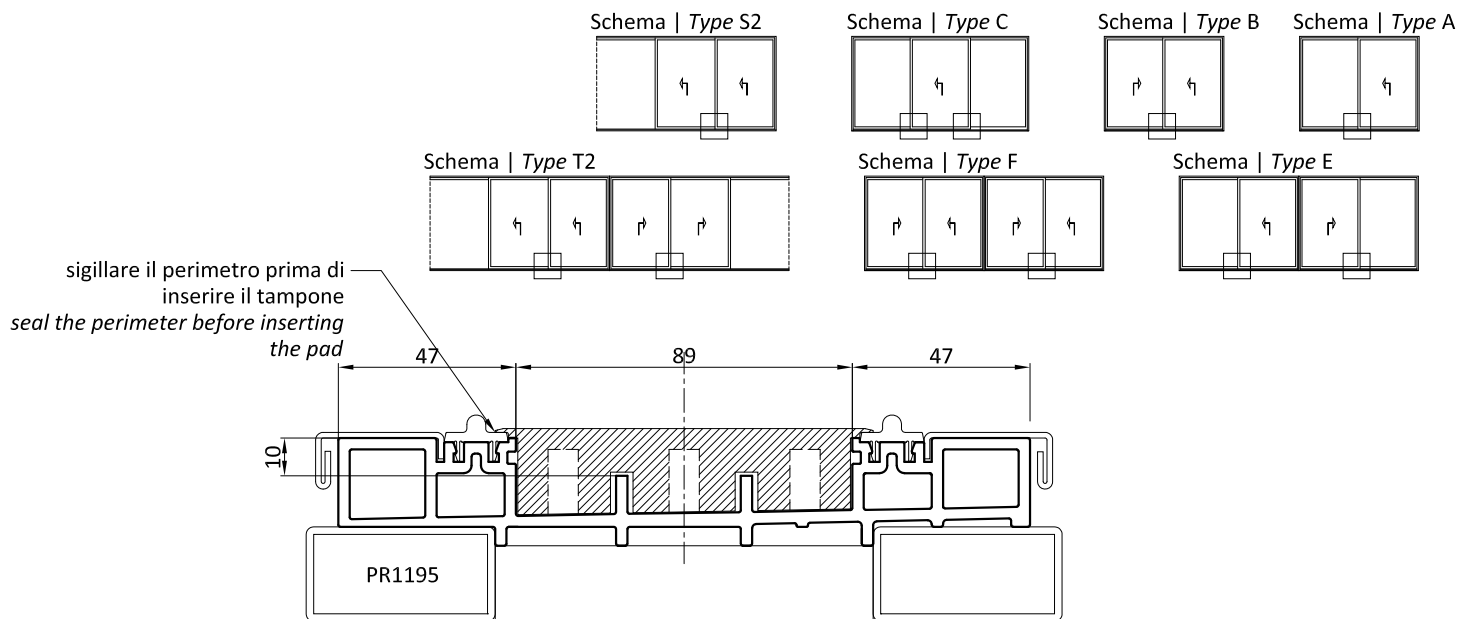

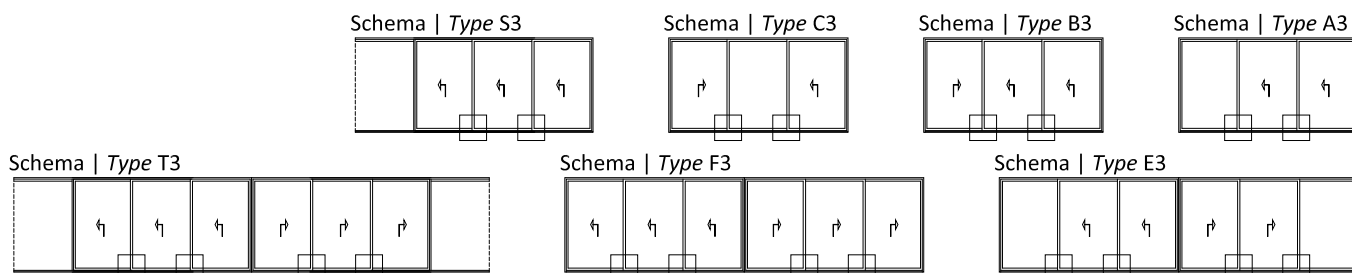

sigillare il perimetro prima di inserire il tampone  
seal the perimeter before inserting the pad

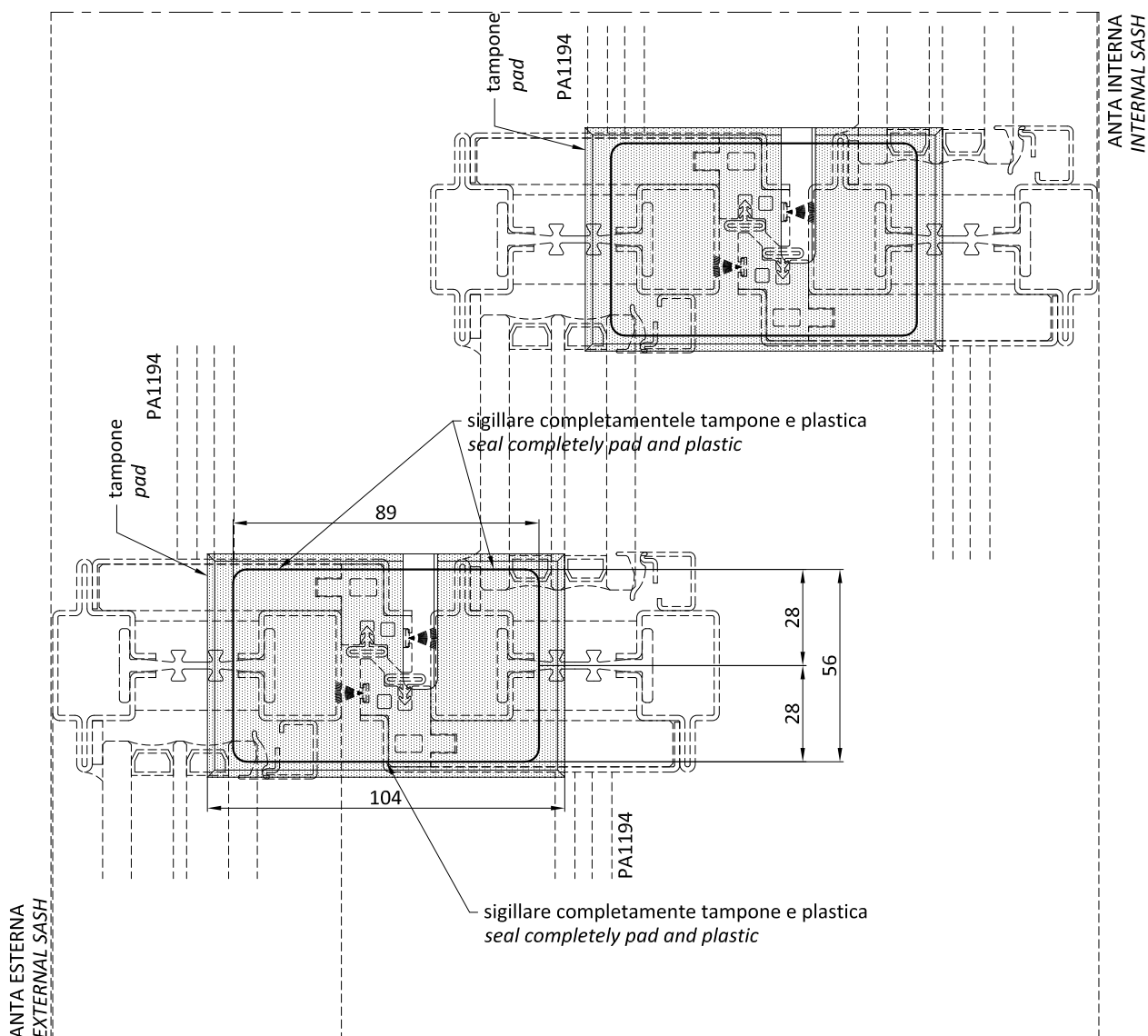
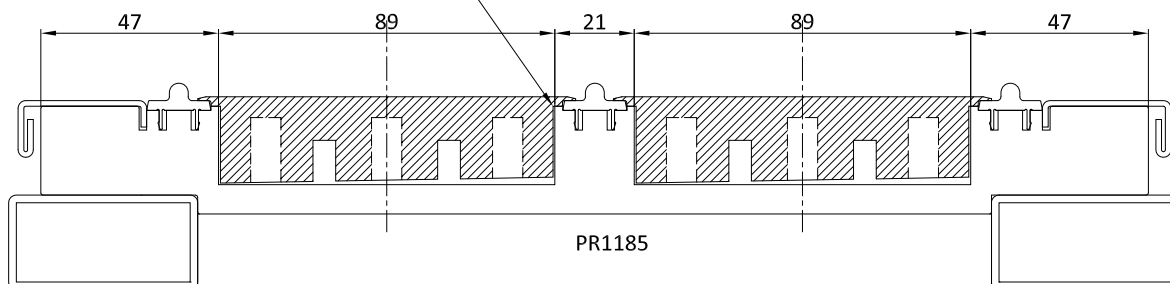

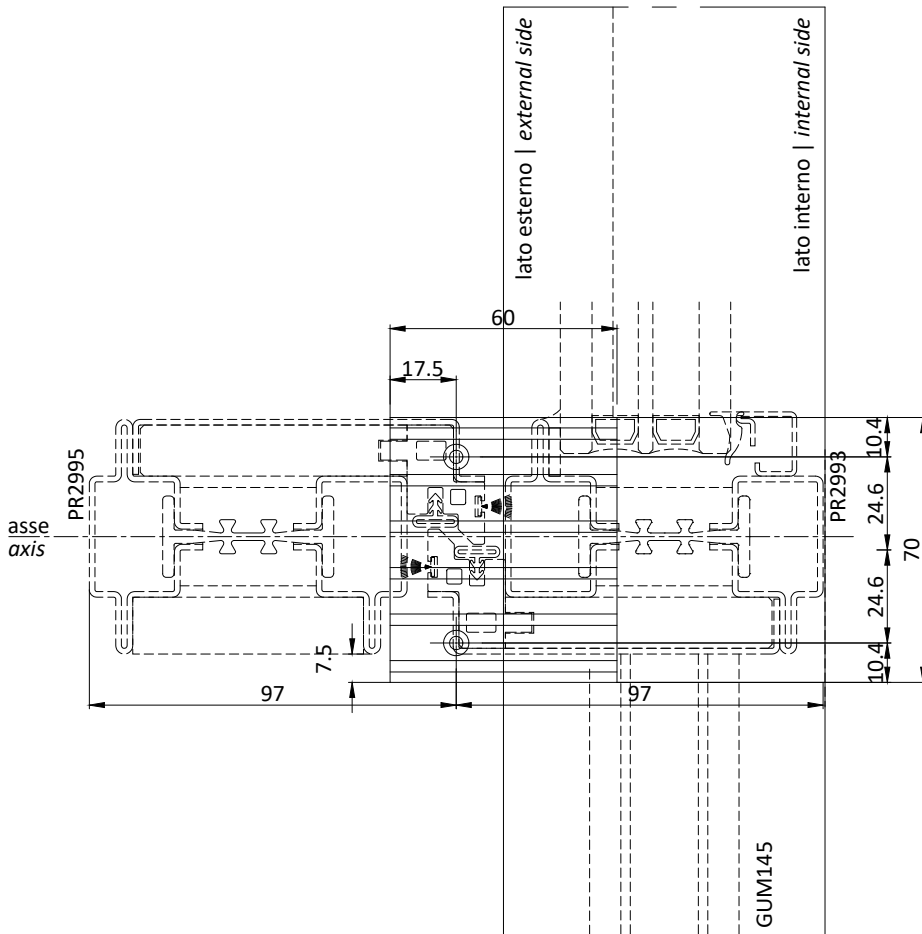
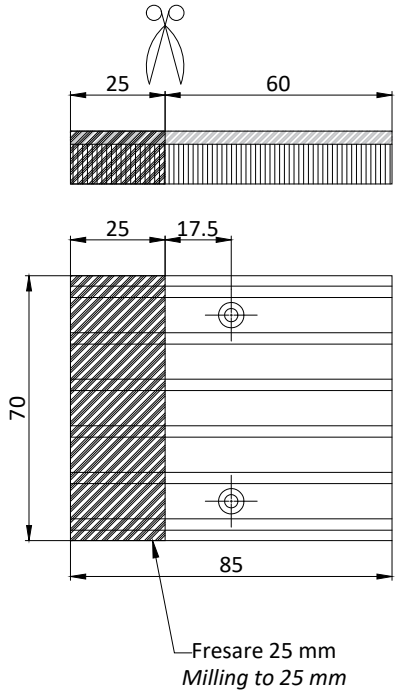
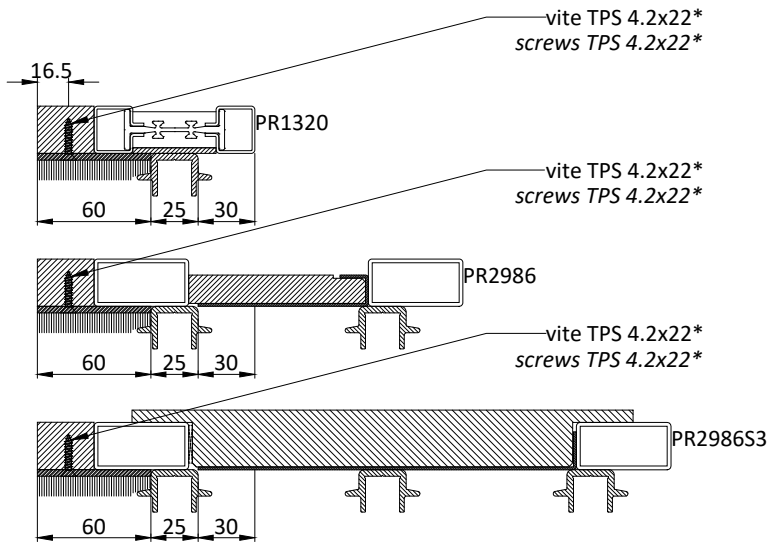
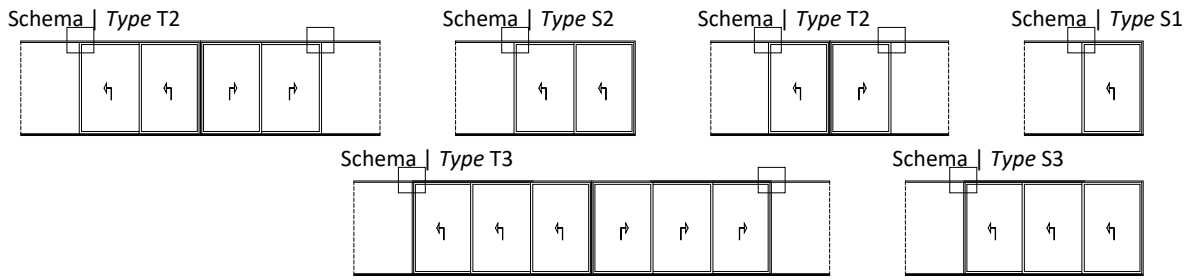

NOTE:

- Inserire e fissare la prima guida con la rispettiva anta
- Inserire e fissare il tampone
- Inserire e fissare la seconda guida con la rispettiva anta

NOTE:

- Insert and attach the first rail with respective sash
- Insert and attach the pad
- Insert and attach the second rail with respective sash

\* viti TPS 4.2x22 non comprese  
\* screws TPS 4.2x22 not supplied





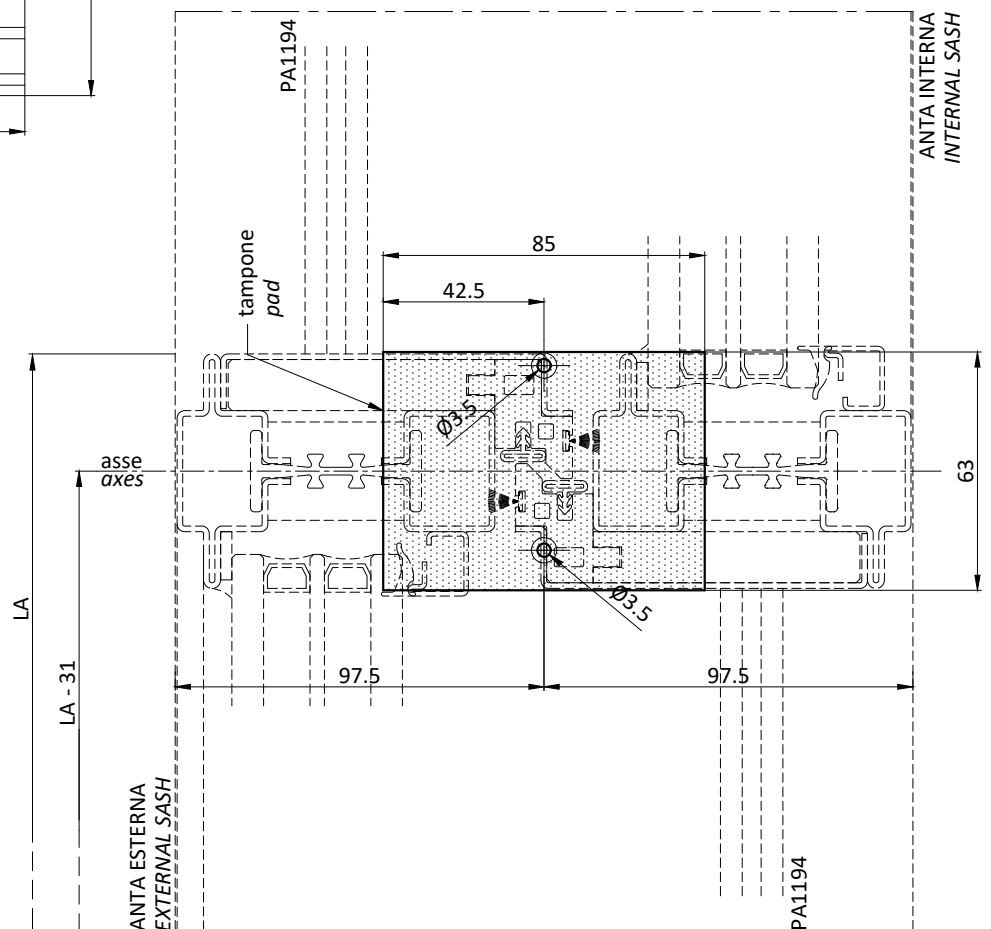
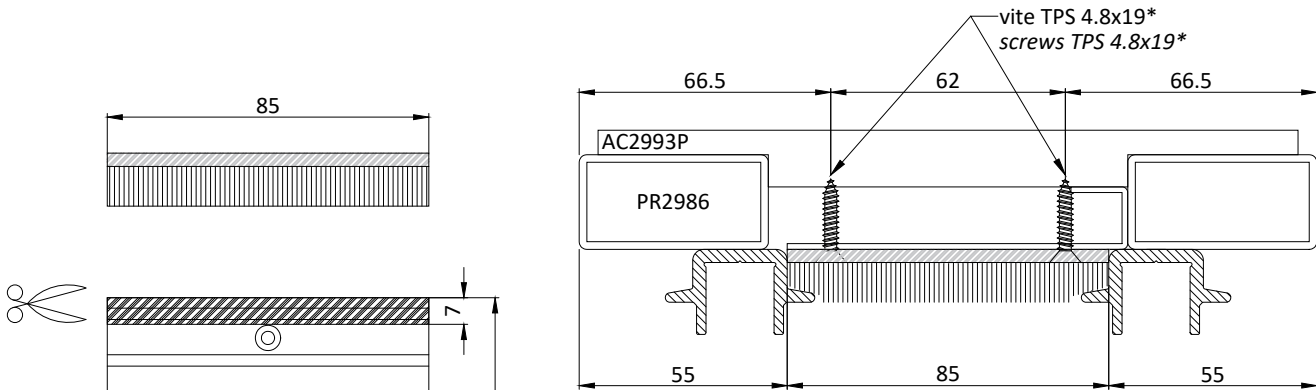
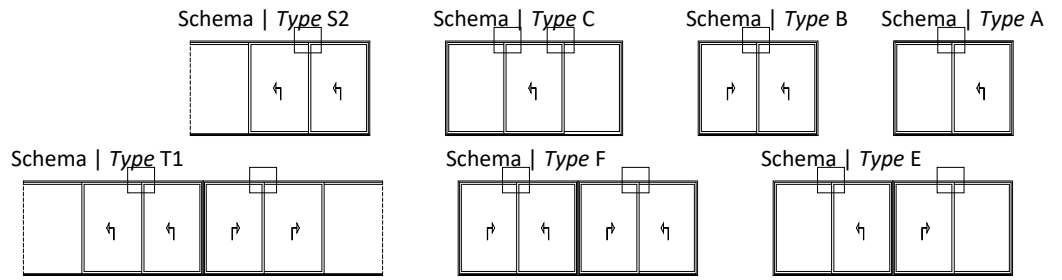

NOTE:

- Inserire e fissare la prima guida con la rispettiva anta
- Inserire e fissare il tampone
- Inserire e fissare la seconda guida con la rispettiva anta

NOTE:

- Insert and attach the first rail with respective sash*
- Insert and attach the pad*
- Insert and attach the second rail with respective sash*

\* viti TPS 4.2 x 19 non comprese  
\* screws TPS 4.2 x 19 not supplied



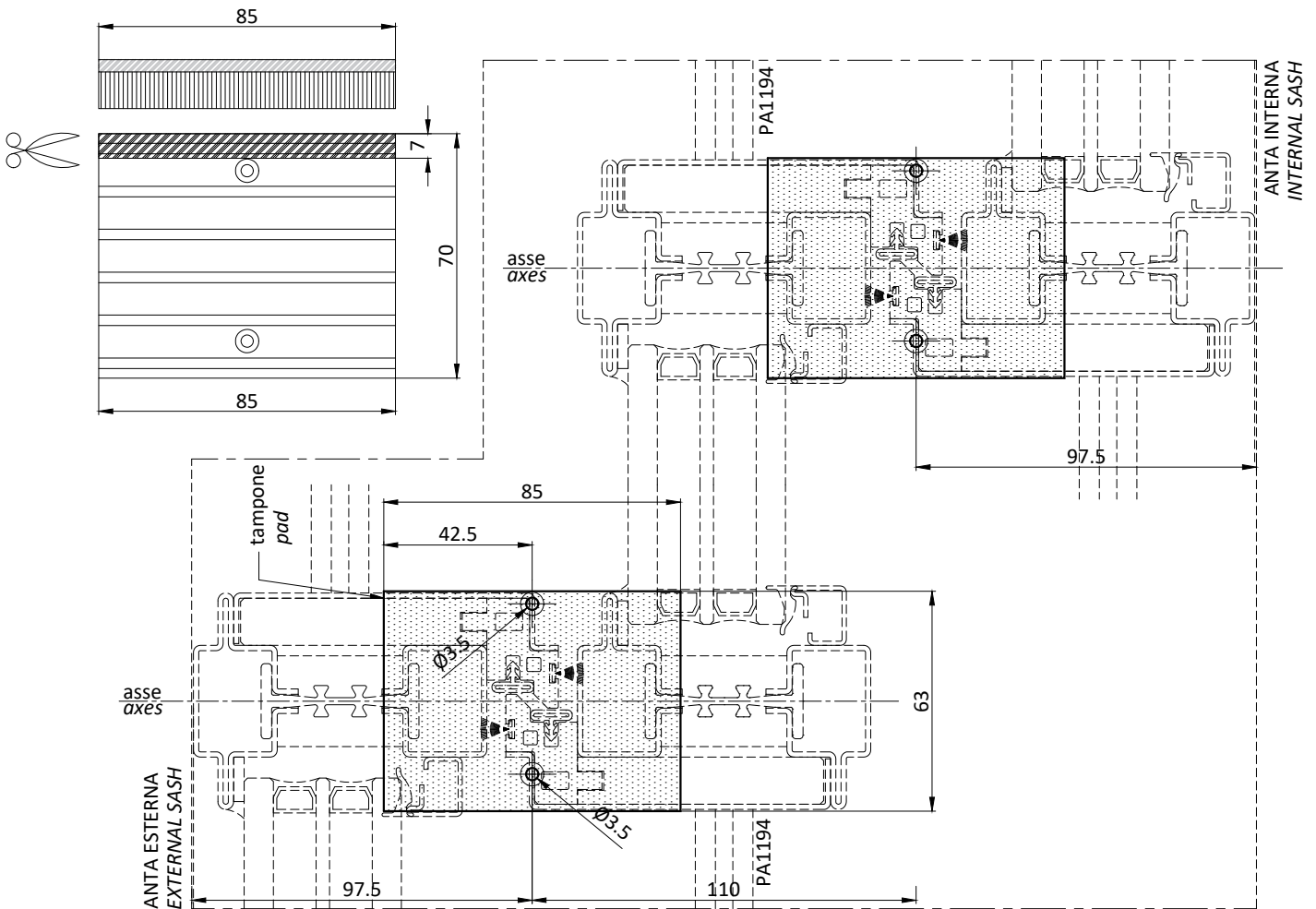
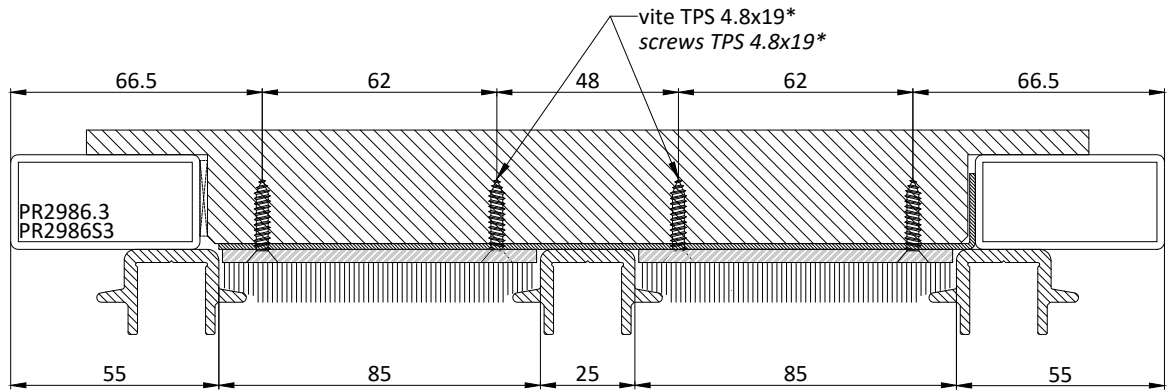
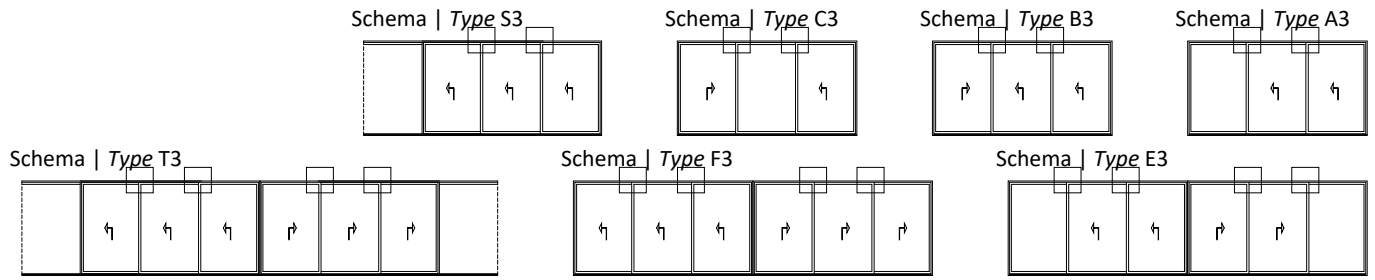

NOTE:

- Inserire e fissare la prima guida con la rispettiva anta
- Inserire e fissare il tampono
- Inserire e fissare la seconda guida con la rispettiva anta

NOTE:

- Insert and attach the first rail with respective sash*
- Insert and attach the pad*
- Insert and attach the second rail with respective sash*

\* viti TPS 4.2 x 19 non comprese  
\* screws TPS 4.2 x 19 not supplied



Schema | Type A

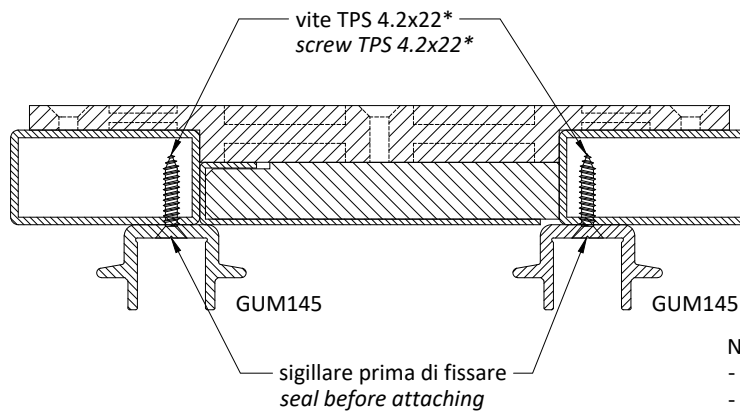
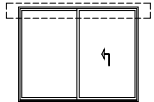

NOTE :

- Preforare il telaio PR2986 prima dell'assemblaggio
- Montare la guida assieme alla posa dell'anta

NOTE:

- Perforate frame PR2986 before assemblage
- Mount the rail when attaching the sash

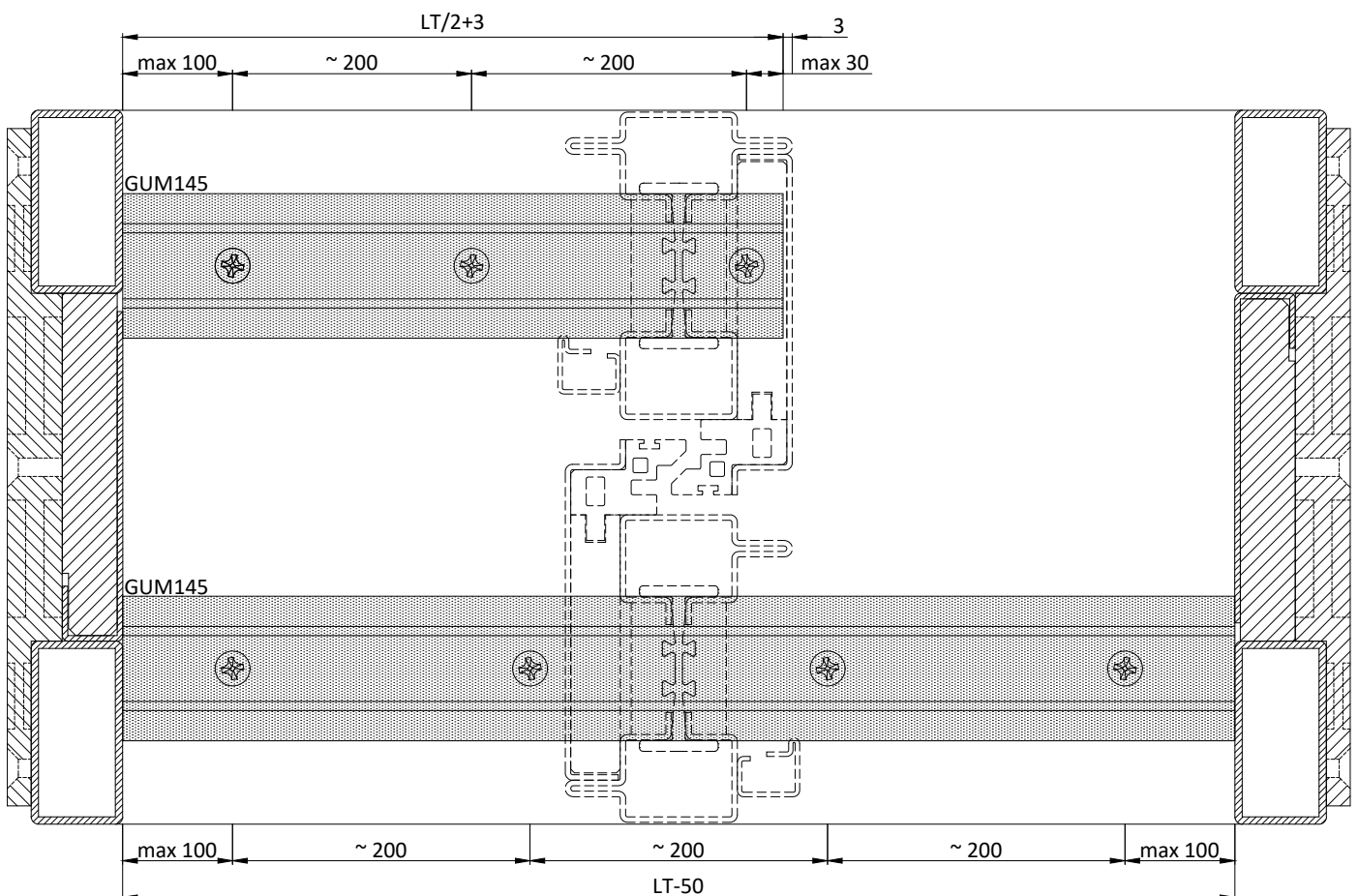

\* viti TPS 4.2x22 non comprese  
\* screws TPS 4.2x22 not supplied

Schema | Type B

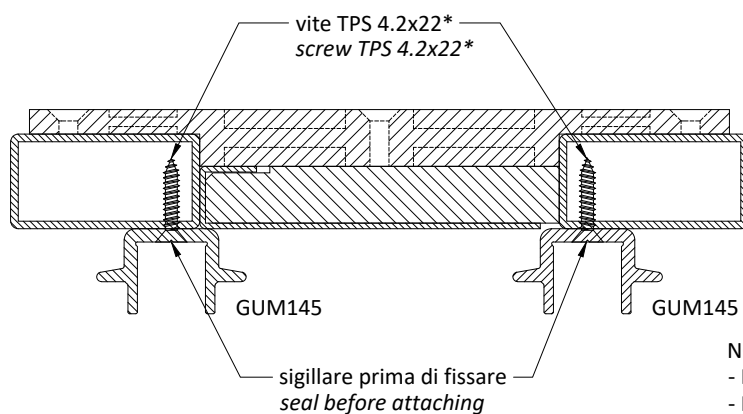
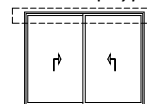

## NOTE :

- Perforare il telaio PR2986 prima dell'assemblaggio
- Montare la guida assieme alla posa dell'anta

## NOTE:

- Perforate frame PR2986 before assemblage
- Mount the rail when attaching the sash

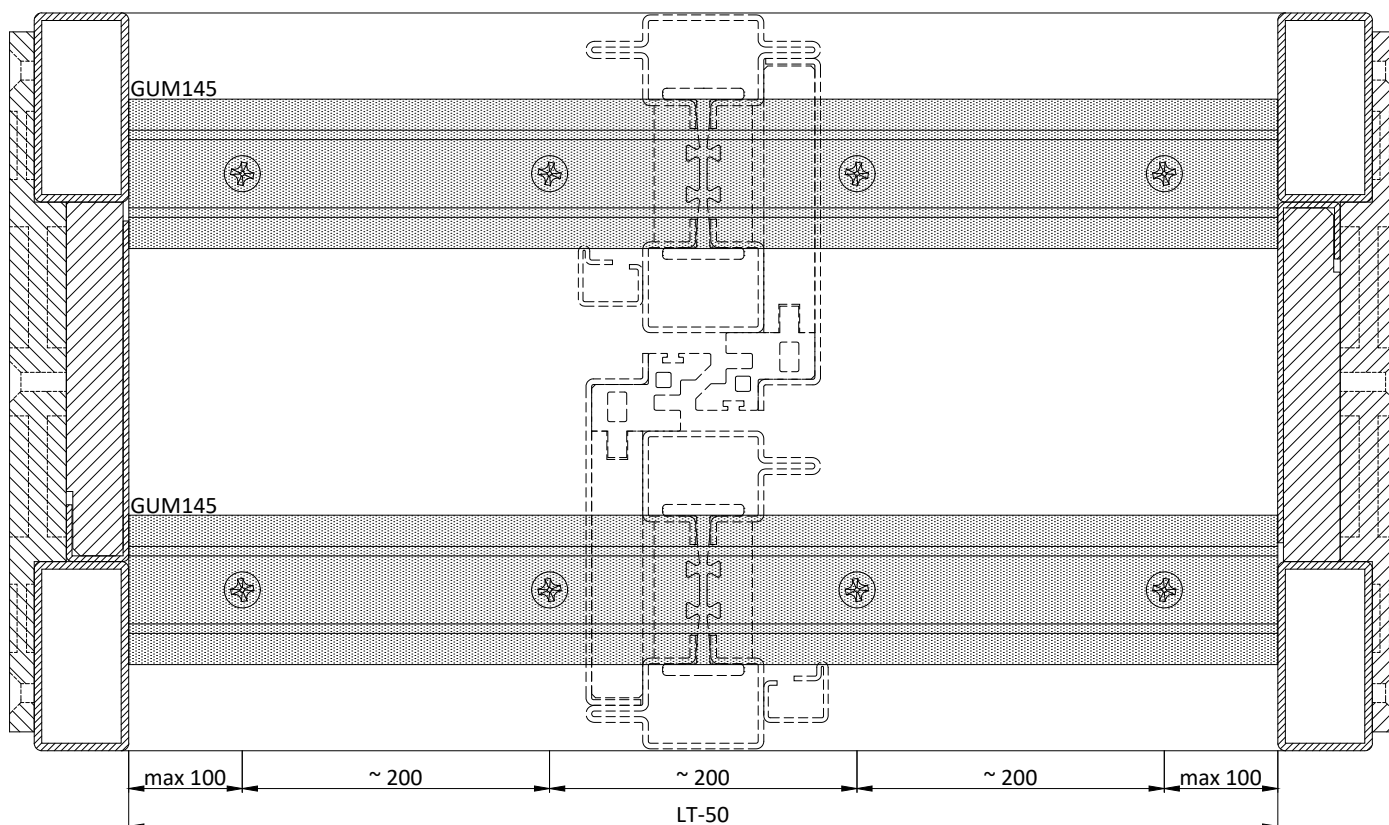

\* viti TPS 4.2x22 non comprese  
\* screws TPS 4.2x22 not supplied

Schema | Type C

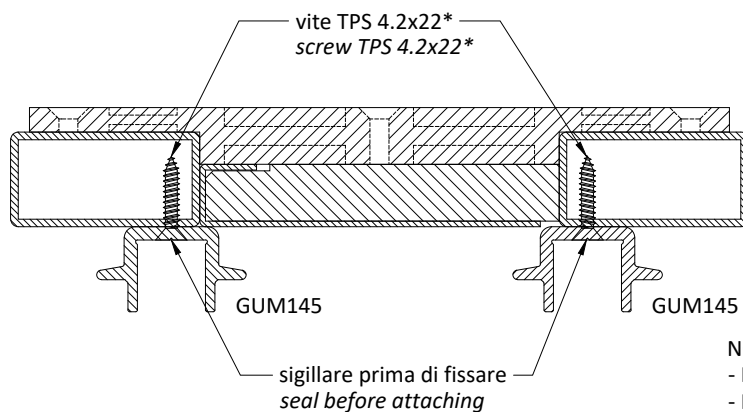
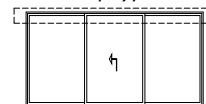

NOTE :

- Preforare il telaio PR2986 prima dell'assemblaggio
- Montare la guida assieme alla posa dell'anta

NOTE:

- Perforate frame PR2986 before assemblage
- Mount the rail when attaching the sash

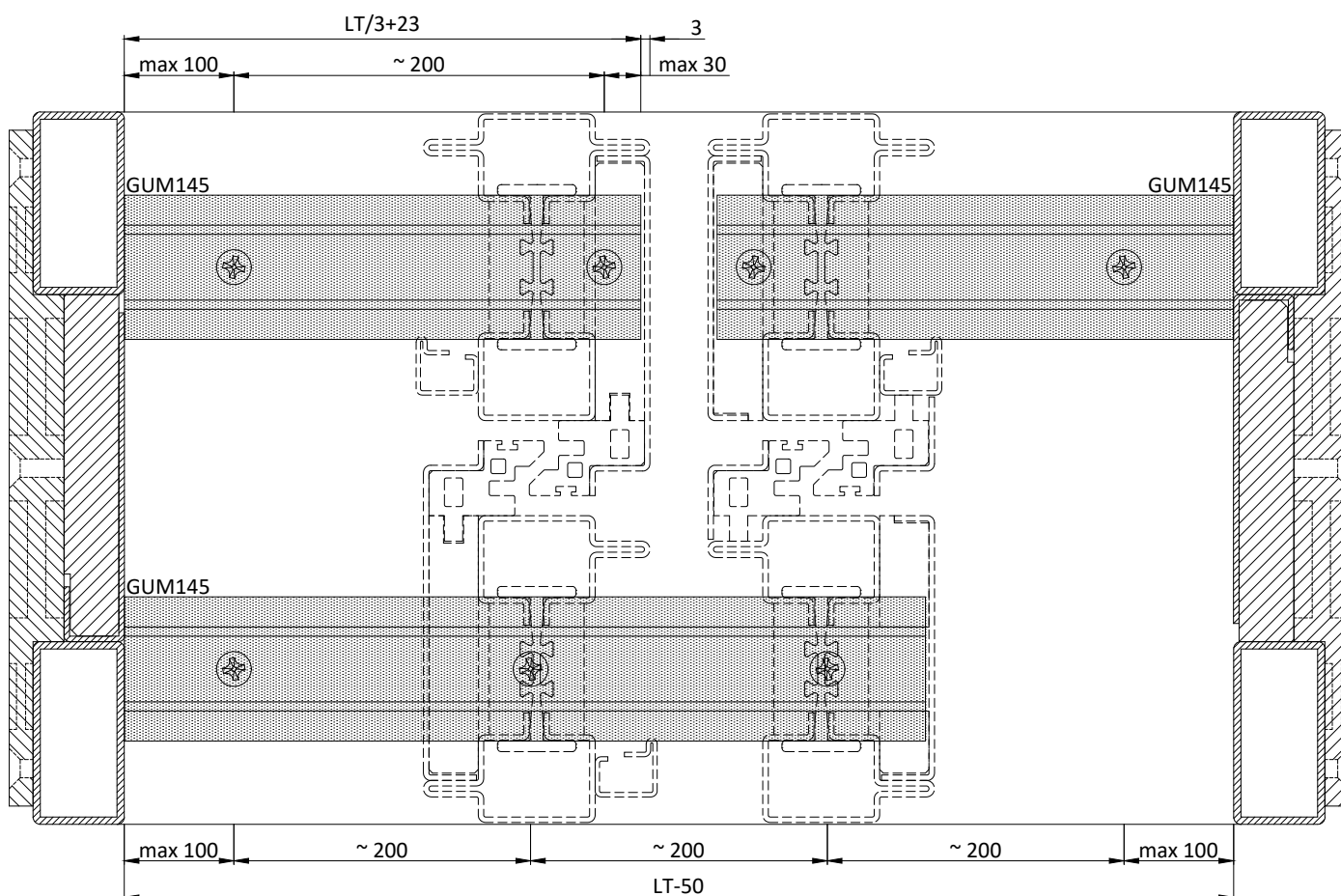

\* viti TPS 4.2x22 non comprese  
\* screws TPS 4.2x22 not supplied

Schema | Type E

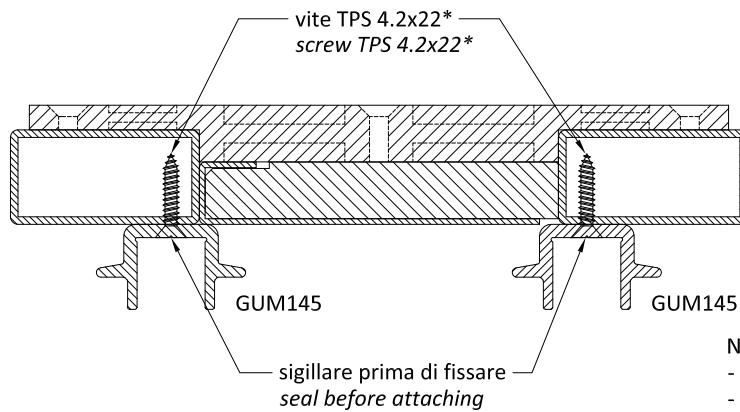
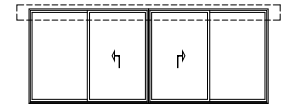

NOTE :

- Preforare il telaio PR2986 prima dell'assemblaggio
- Montare la guida assieme alla posa dell'anta

NOTE:

- Perforate frame PR2986 before assemblage
- Mount the rail when attaching the sash

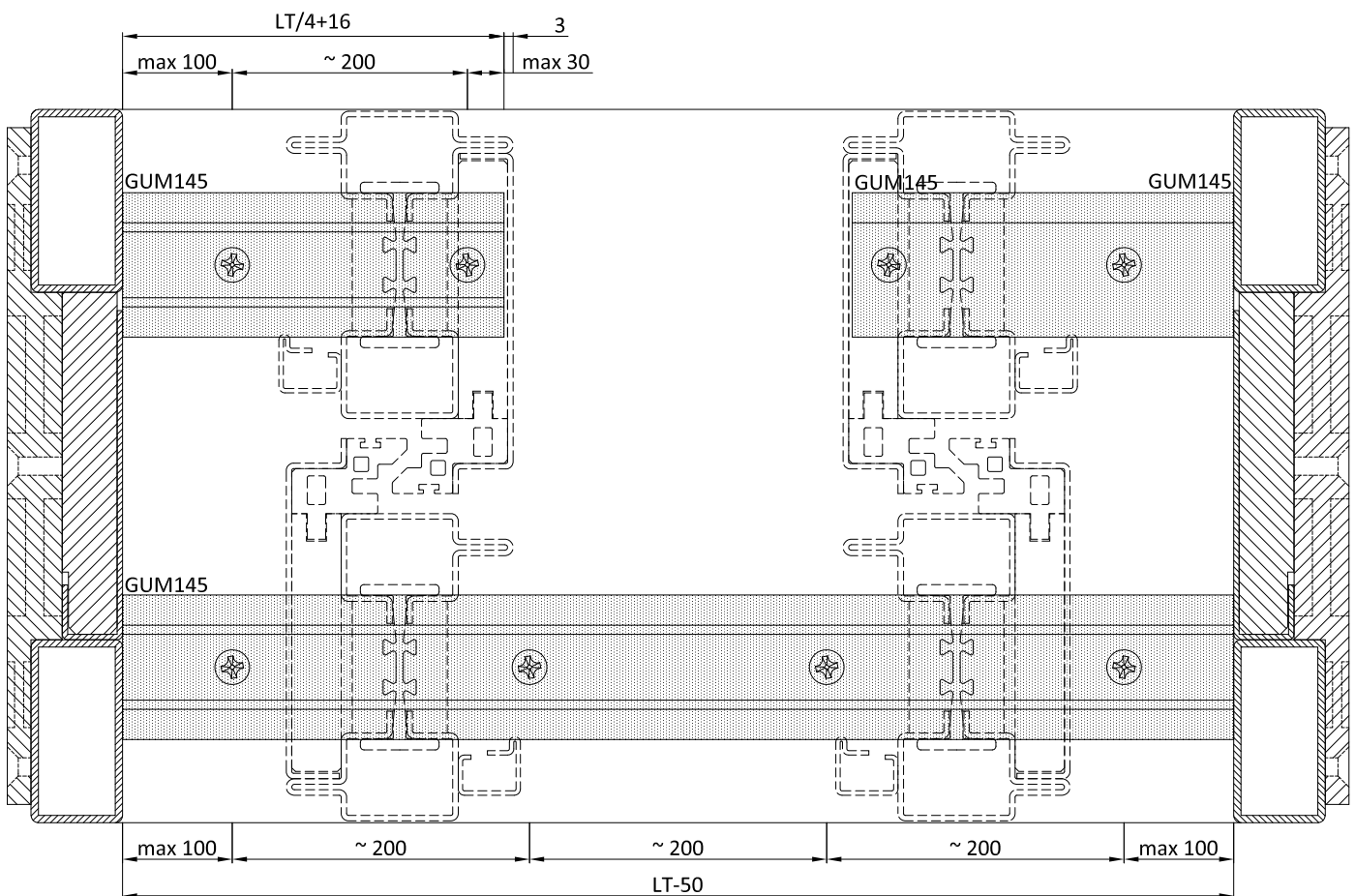

\* viti TPS 4.2x22 non comprese  
 \* screws TPS 4.2x22 not supplied

Schema | Type F

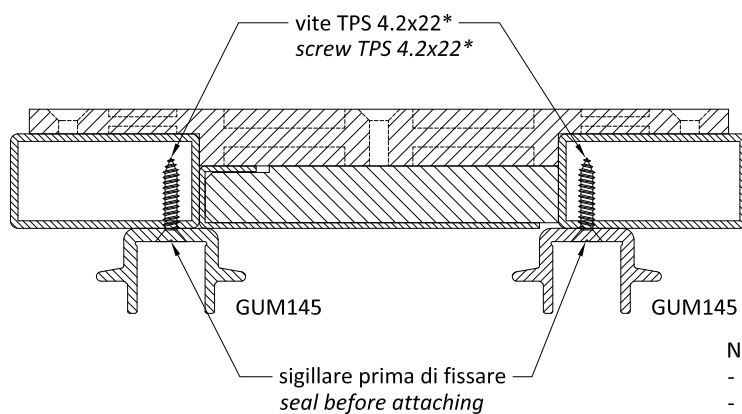
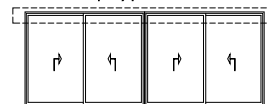

NOTE :

- Perforare il telaio PR2986 prima dell'assemblaggio
- Montare la guida assieme alla posa dell'anta

NOTE:

- Perforate frame PR2986 before assemblage
- Mount the rail when attaching the sash

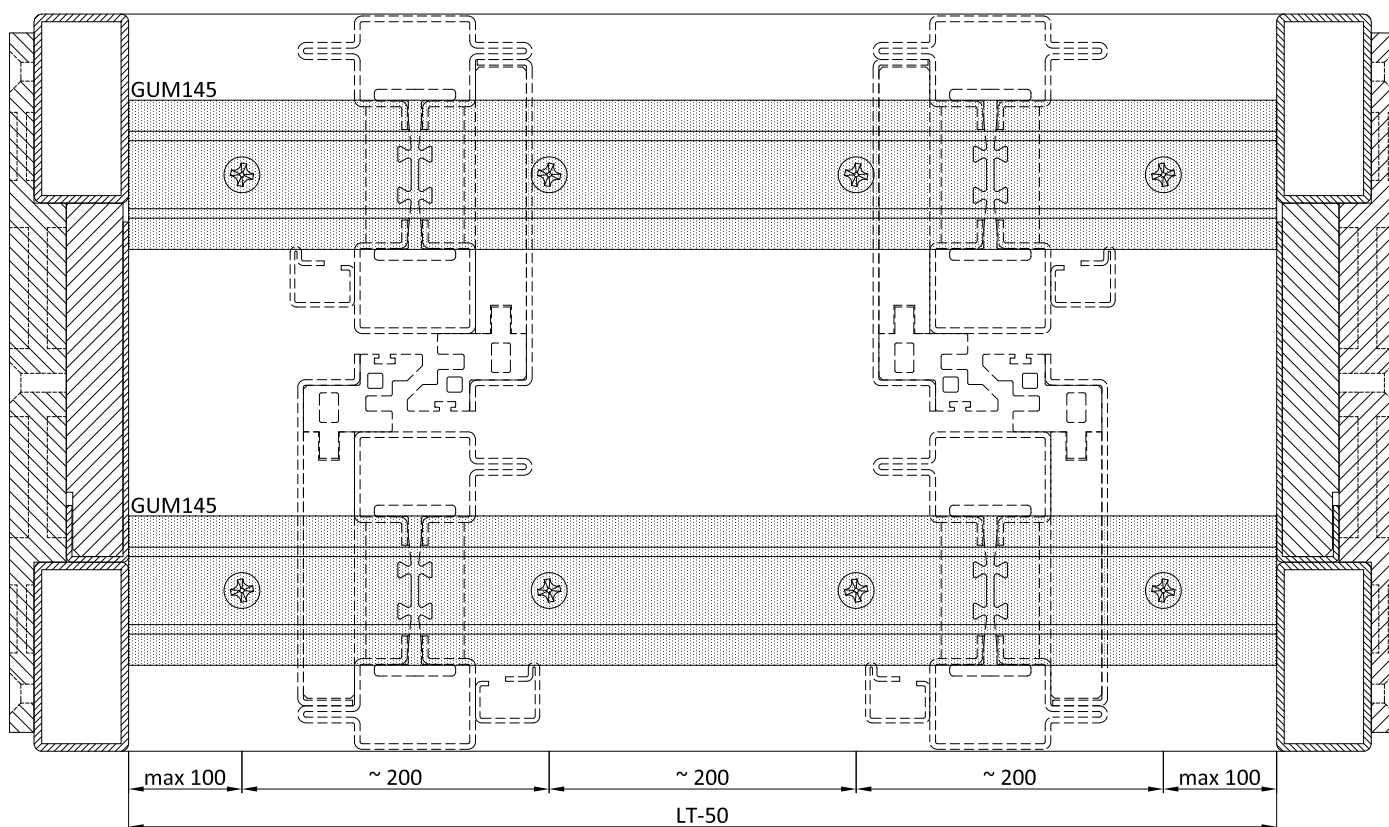

\* viti TPS 4.2x22 non comprese  
\* screws TPS 4.2x22 not supplied

Schema | Type A3

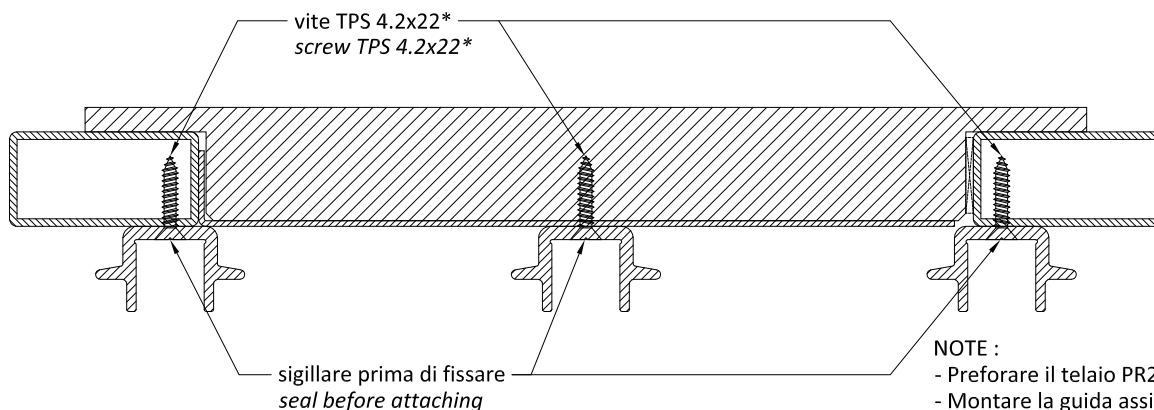
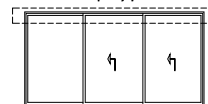

NOTE :  
 - Preforare il telaio PR2986.3 prima dell'assemblaggio  
 - Montare la guida assieme alla posa dell'anta

NOTE:  
 - Perforate frame PR2986.3 before assemblage  
 - Mount the rail when attaching the sash

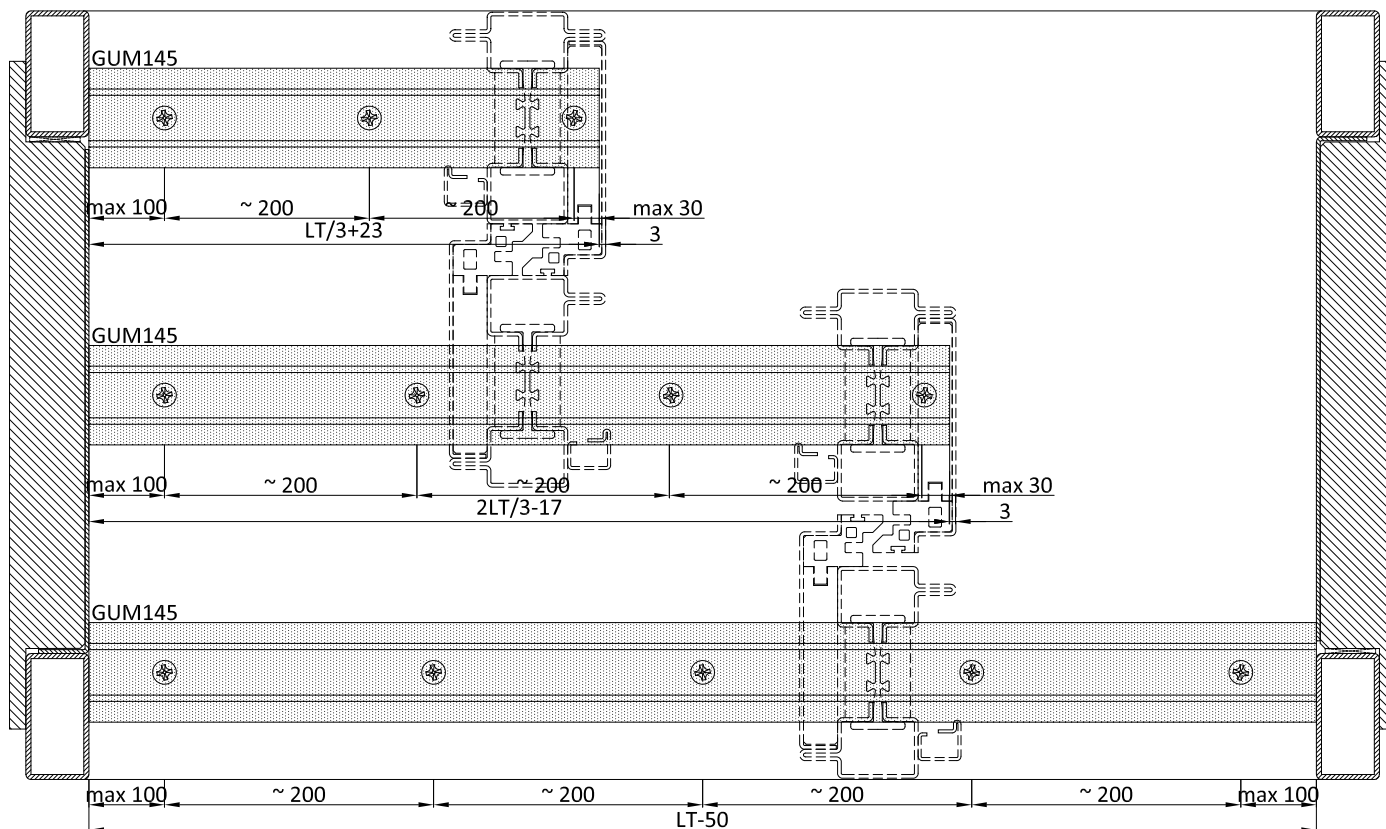

\* viti TPS 4.2x22 non comprese  
 \* screws TPS 4.2x22 not supplied



Schema | Type B3

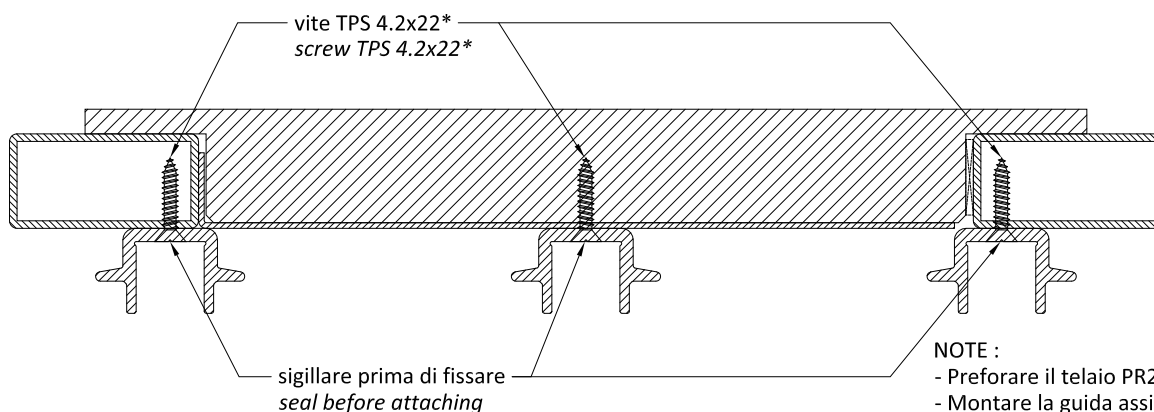
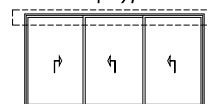

NOTE :

- Preforare il telaio PR2986.3 prima dell'assemblaggio
- Montare la guida assieme alla posa dell'anta

NOTE:

- Perforate frame PR2986.3 before assemblage
- Mount the rail when attaching the sash

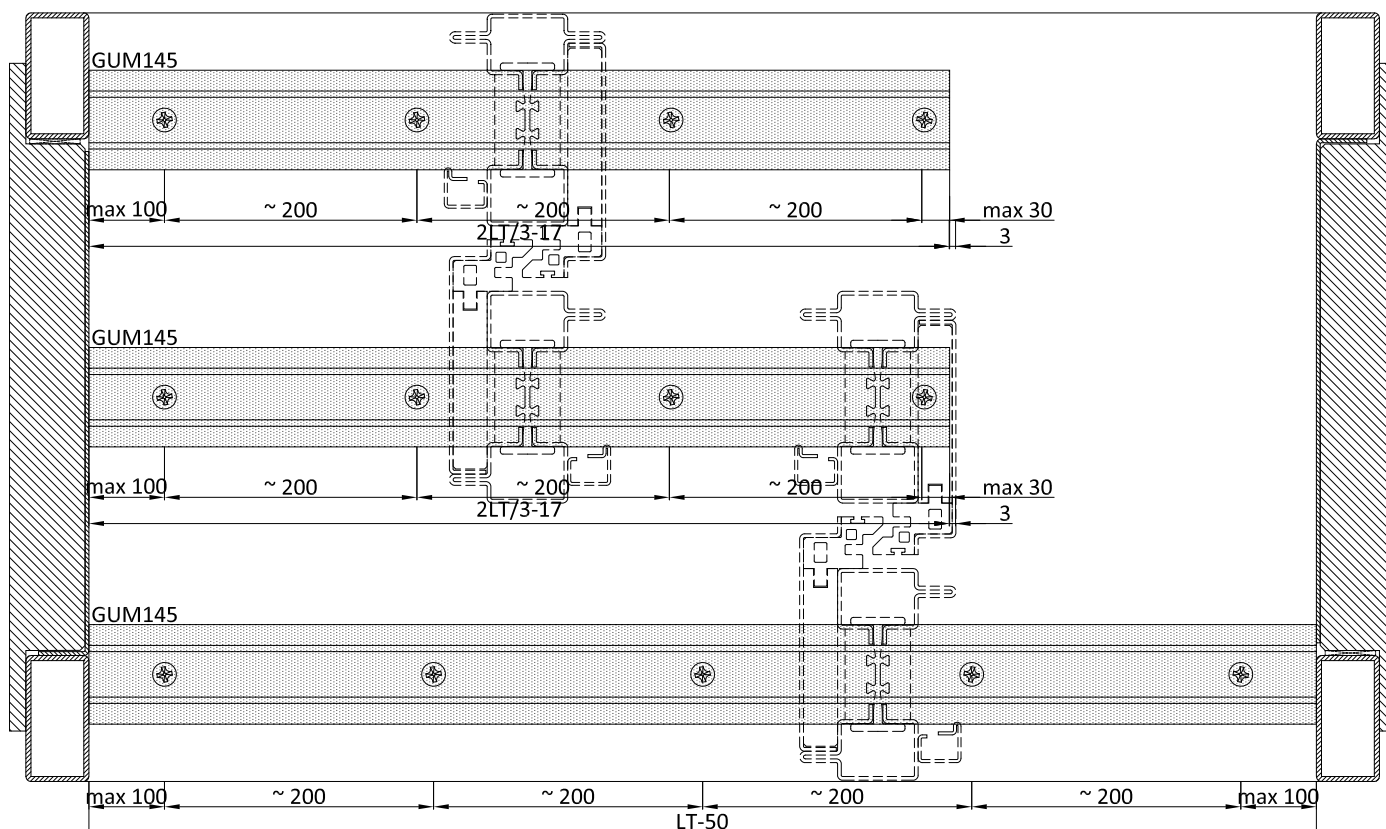

\* viti TPS 4.2x22 non comprese  
\* screws TPS 4.2x22 not supplied

Schema | Type C3

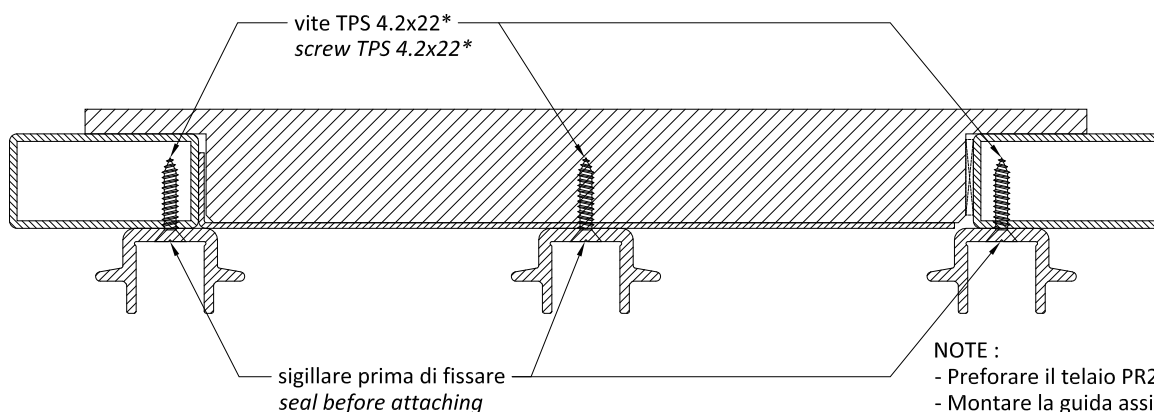

NOTE :

- Preforare il telaio PR2986.3 prima dell'assemblaggio
- Montare la guida assieme alla posa dell'anta

NOTE:

- Perforate frame PR2986.3 before assemblage
- Mount the rail when attaching the sash

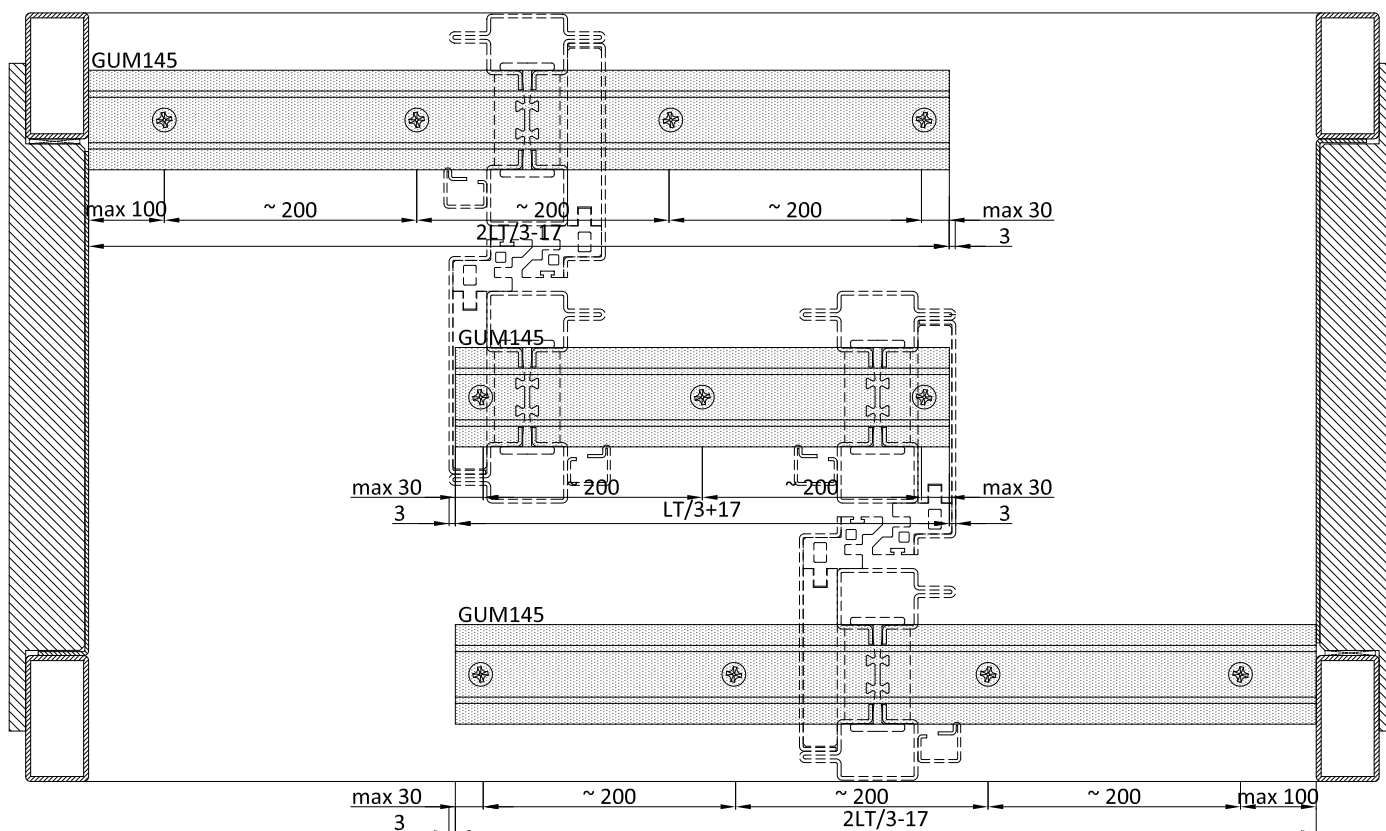

\* viti TPS 4.2x22 non comprese  
\* screws TPS 4.2x22 not supplied

Schema | Type E3

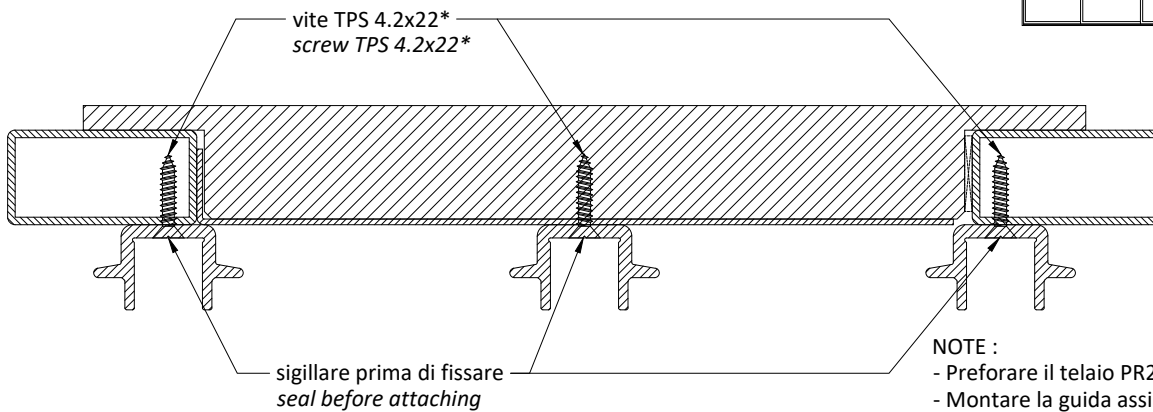
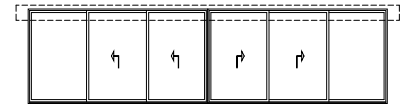

NOTE :  
 - Preforare il telaio PR2986.3 prima dell'assemblaggio  
 - Montare la guida assieme alla posa dell'anta

NOTE:  
 -Perforate frame PR2986.3 before assemblage  
 -Mount the rail when attaching the sash

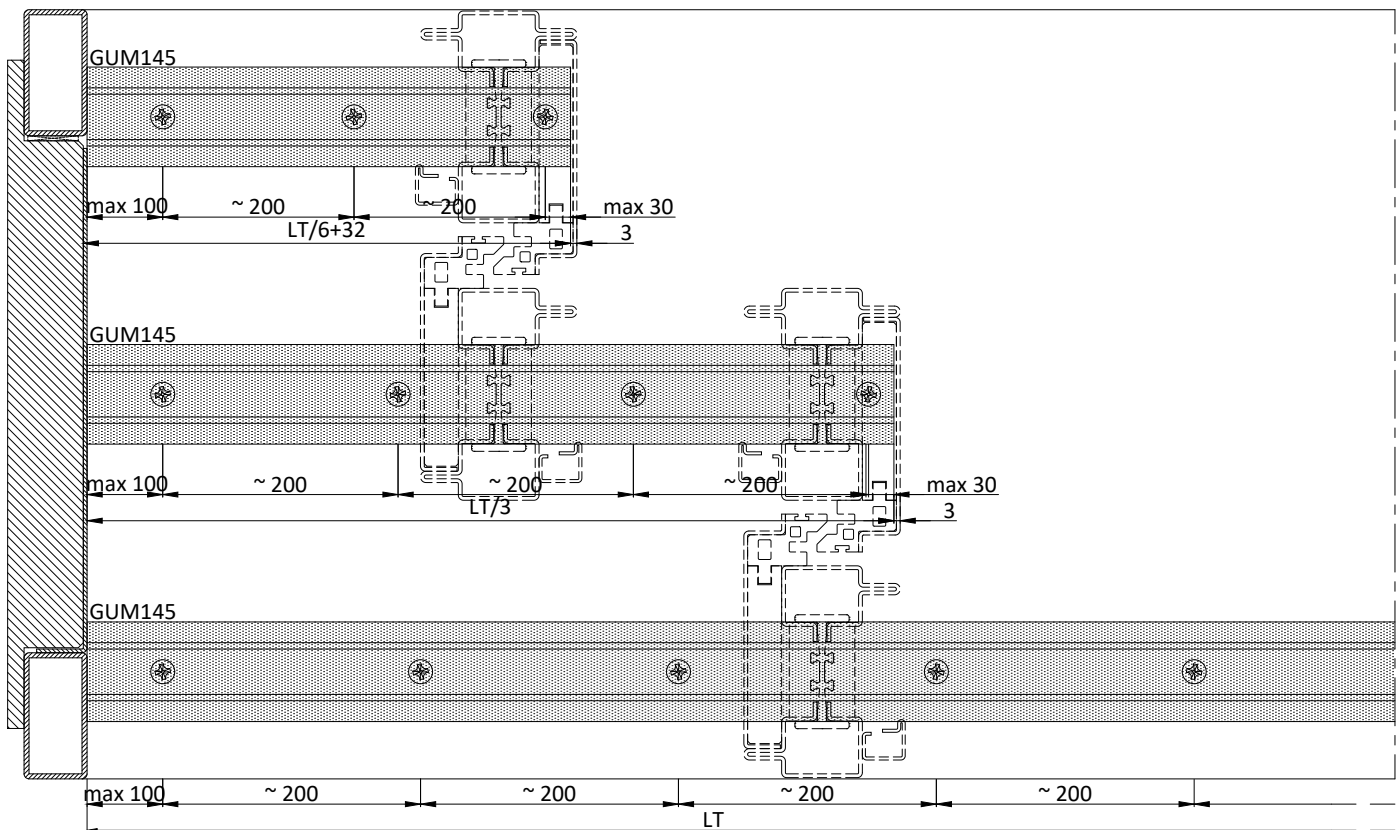

\* viti TPS 4.2x22 non comprese  
 \* screws TPS 4.2x22 not supplied

Schema | Type F3

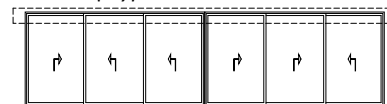
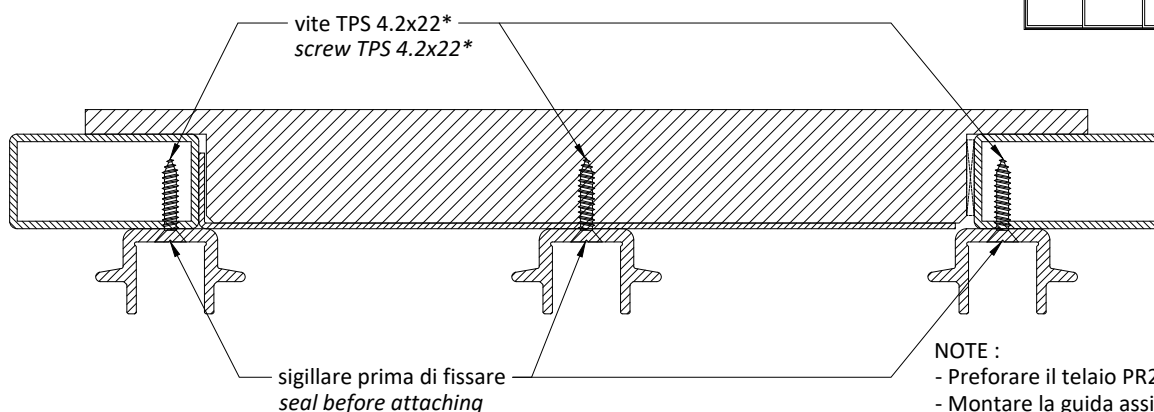

NOTE :

- Preforare il telaio PR2986.3 prima dell'assemblaggio
- Montare la guida assieme alla posa dell'anta

NOTE:

- Perforate frame PR2986.3 before assemblage
- Mount the rail when attaching the sash

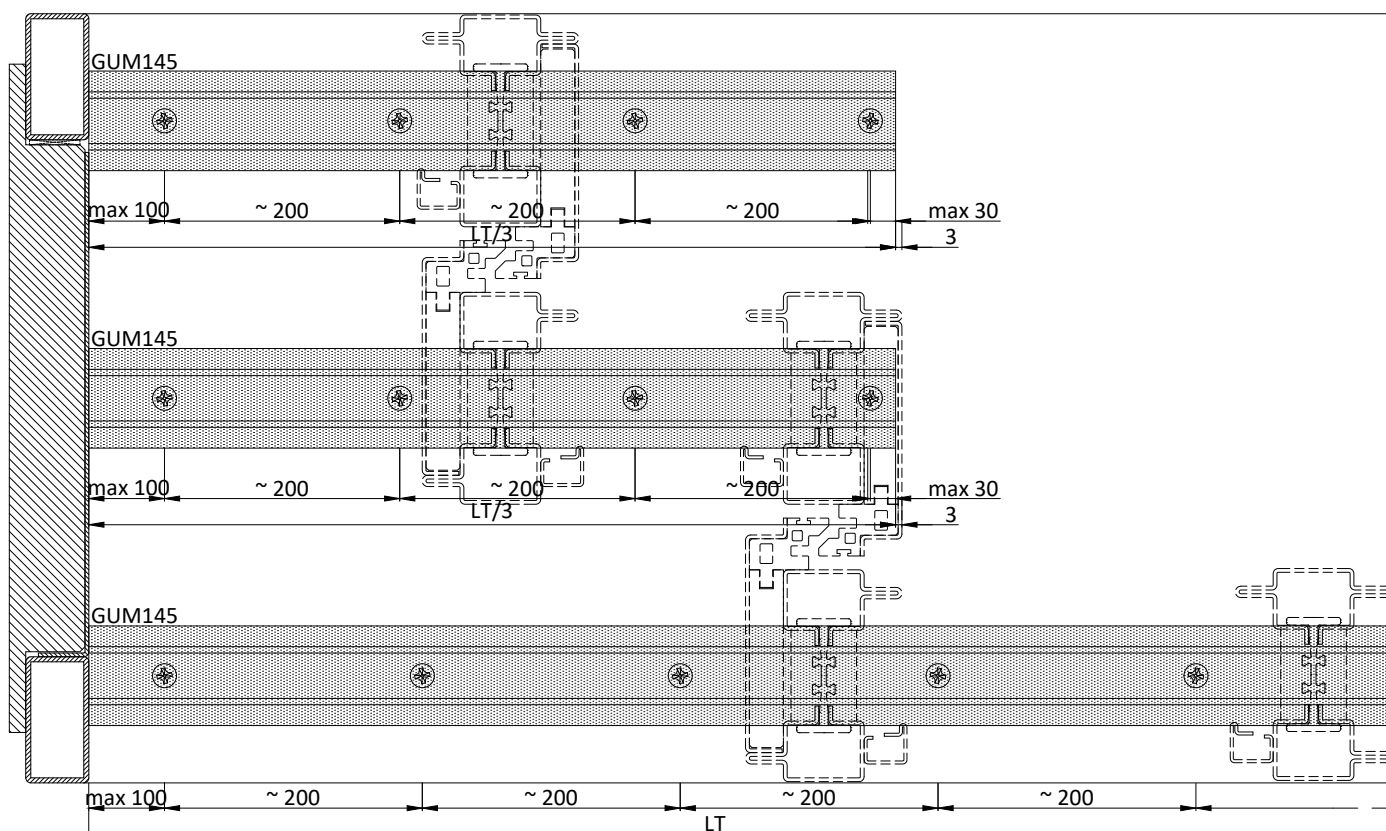

\* viti TPS 4.2x22 non comprese  
\* screws TPS 4.2x22 not supplied

Schema | Type S1

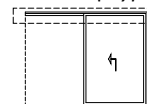

vite TPS 4.2x22\*  
screw TPS 4.2x22\*

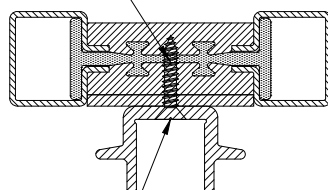

sigillare prima di fissare  
seal before attaching

NOTE :

- Preforare il telaio PR1320 prima dell'assemblaggio
- Montare la guida assieme alla posa dell'anta

NOTE:

- Perforate frame PR1320 before assemblage
- Mount the rail when attaching the sash

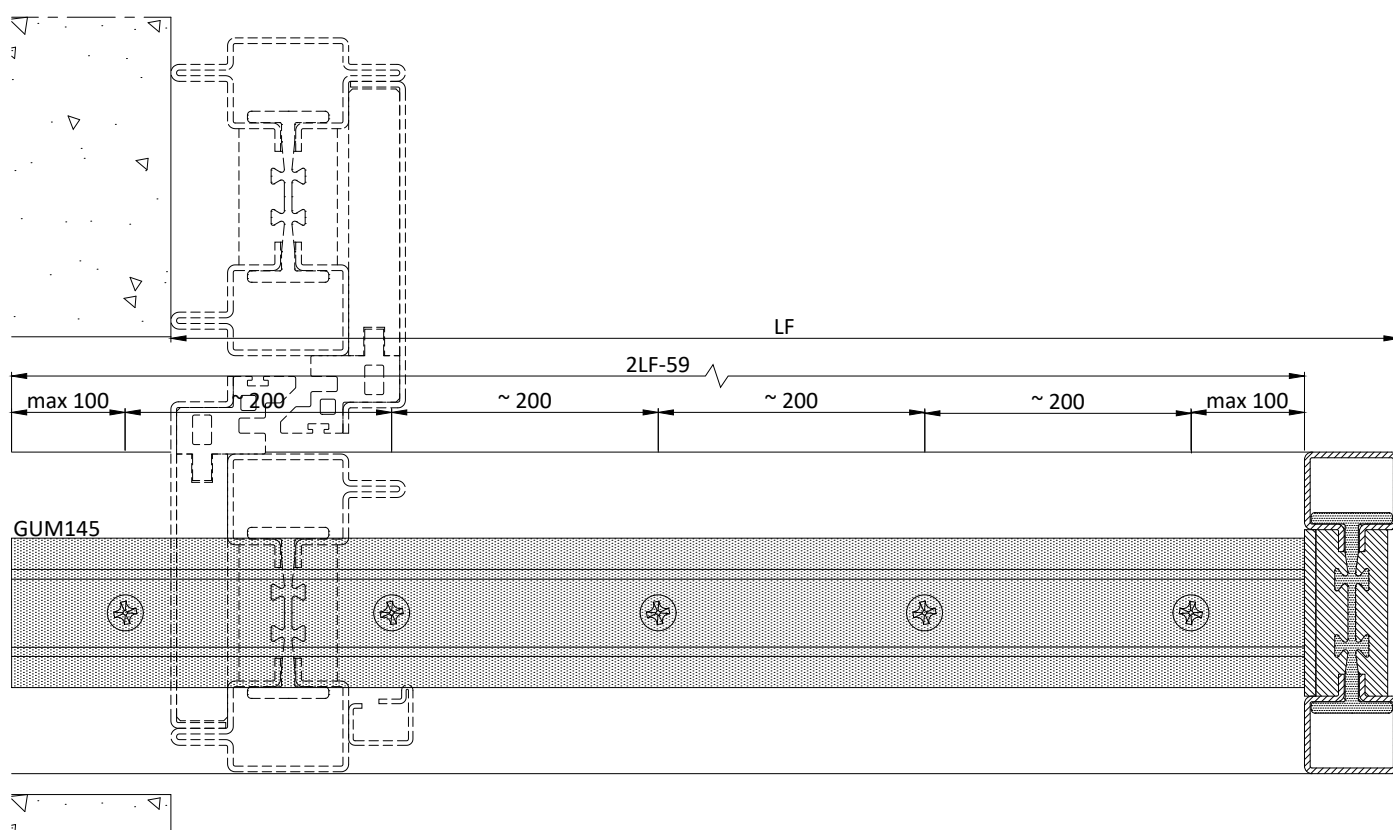

\* viti TPS 4.2x22 non comprese  
\* screws TPS 4.2x22 not supplied

Schema | Type T1

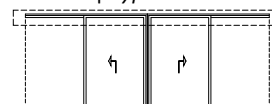

vite TPS 4.2x22\*  
screw TPS 4.2x22\*

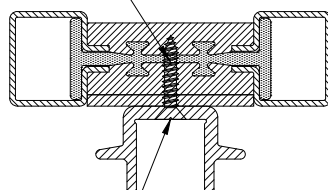

sigillare prima di fissare  
seal before attaching

NOTE :

- Preforare il telaio PR1320 prima dell'assemblaggio
- Montare la guida assieme alla posa dell'anta

NOTE:

- Perforate frame PR1320 before assemblage
- Mount the rail when attaching the sash

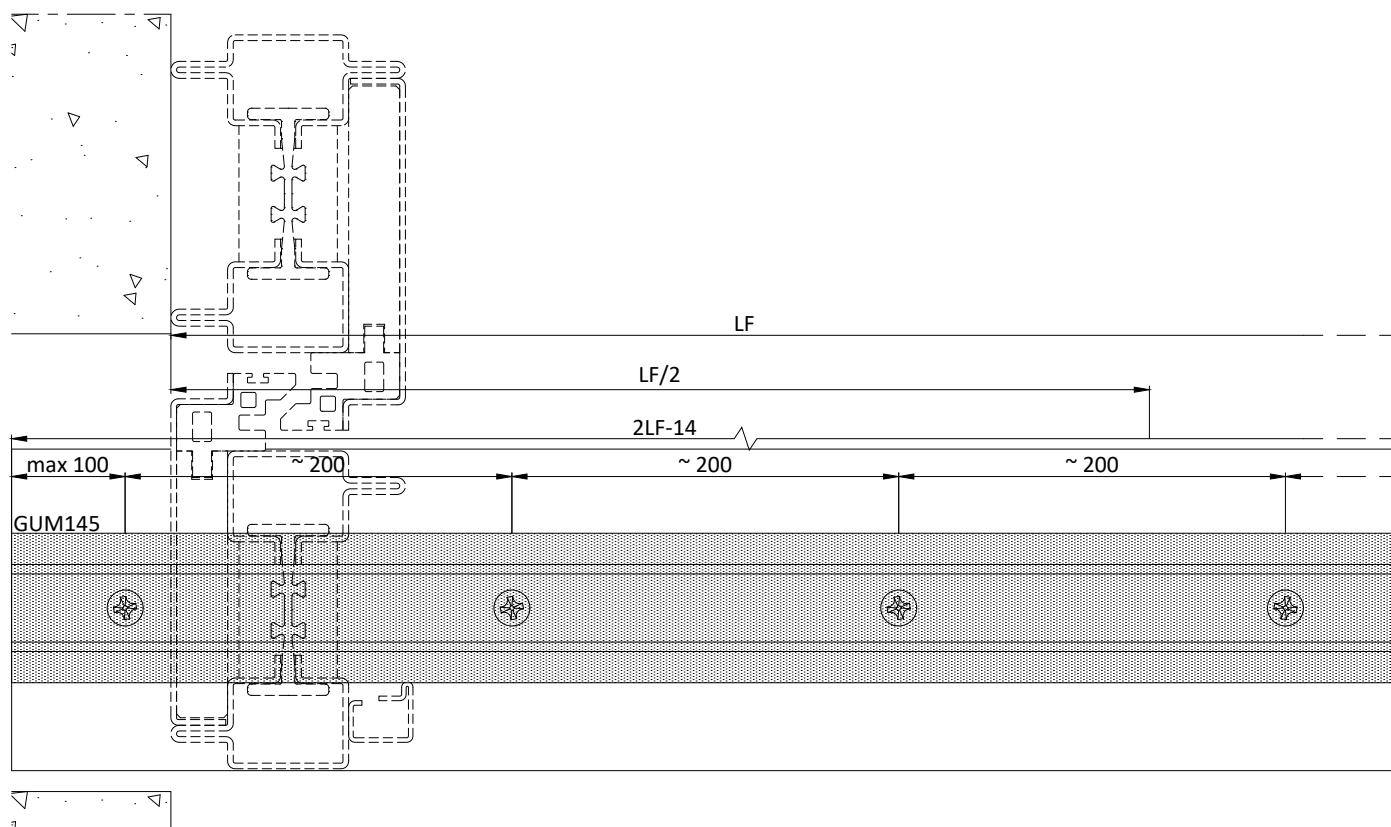

\* viti TPS 4.2x22 non comprese  
\* screws TPS 4.2x22 not supplied

Schema | Type S2

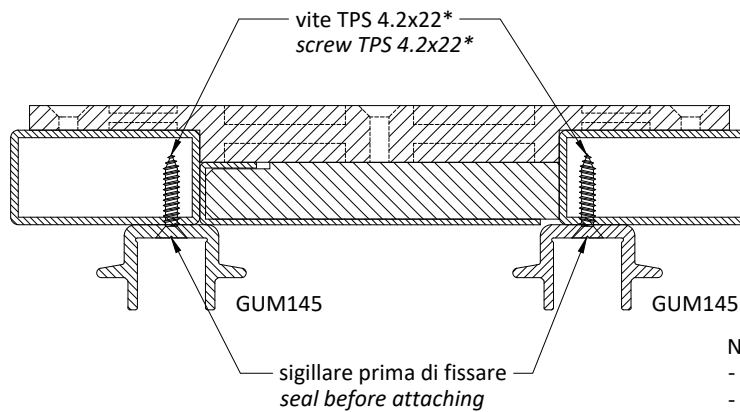
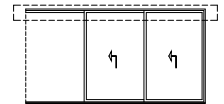

NOTE :

- Preforare il telaio PR2986 prima dell'assemblaggio
- Montare la guida assieme alla posa dell'anta

NOTE:

- Perforate frame PR2986 before assemblage
- Mount the rail when attaching the sash

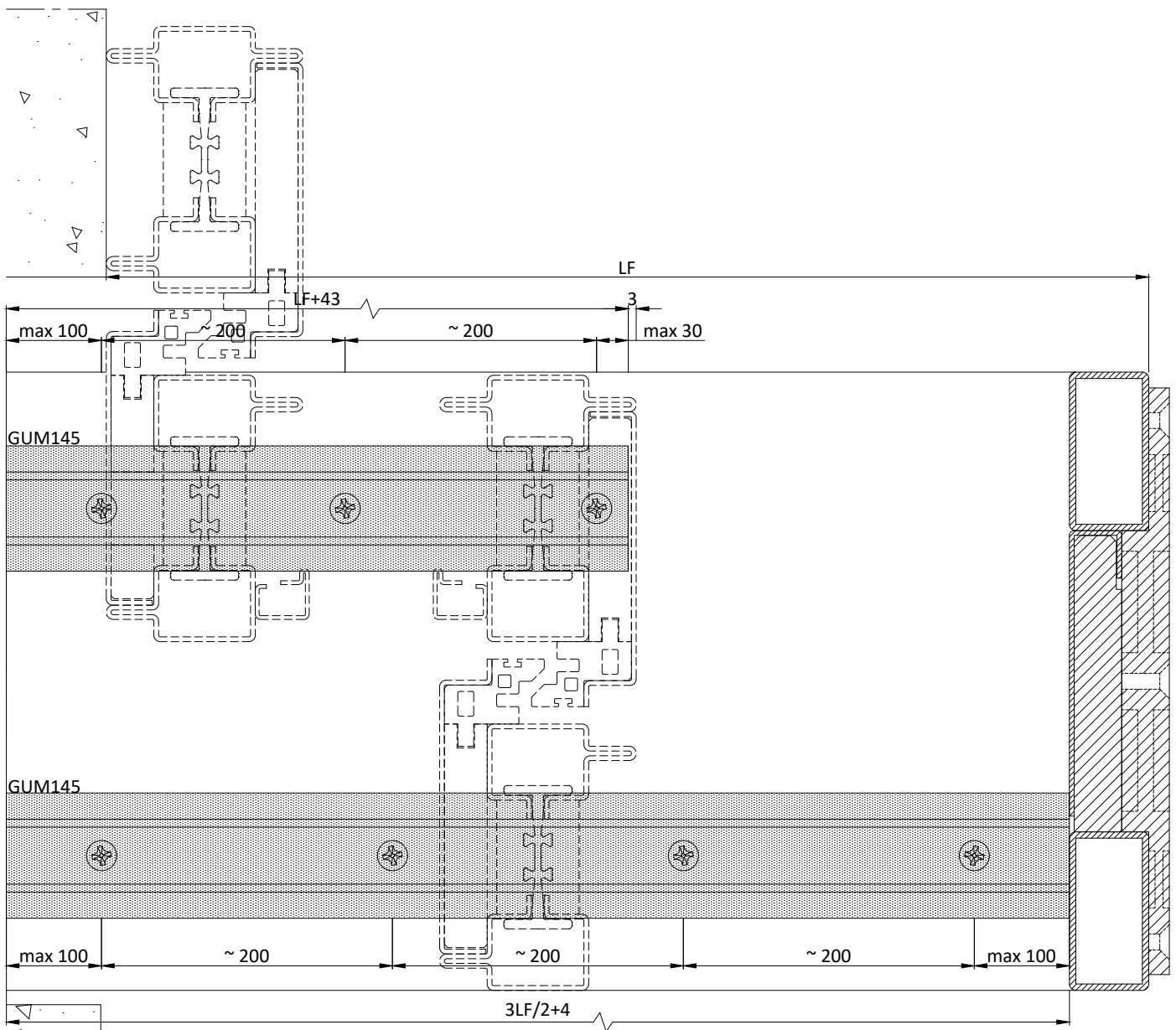

\* viti TPS 4.2x22 non comprese  
\* screws TPS 4.2x22 not supplied

Schema | Type T2

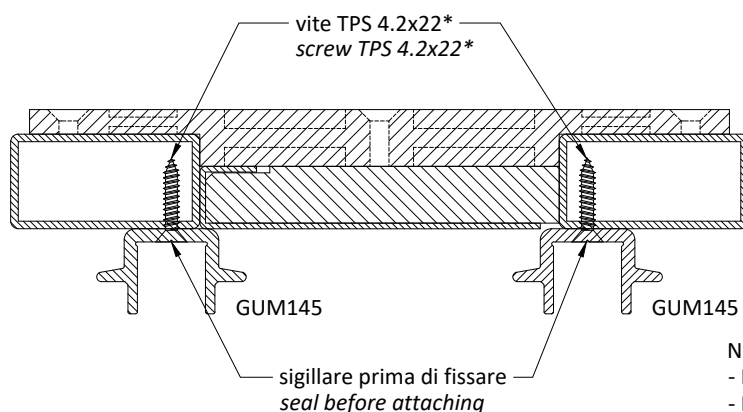
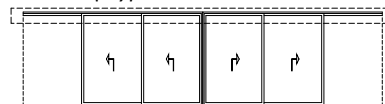

## NOTE :

- Preforare il telaio PR2986 prima dell'assemblaggio
- Montare la guida assieme alla posa dell'anta

## NOTE:

- Perforate frame PR2986 before assemblage
- Mount the rail when attaching the sash

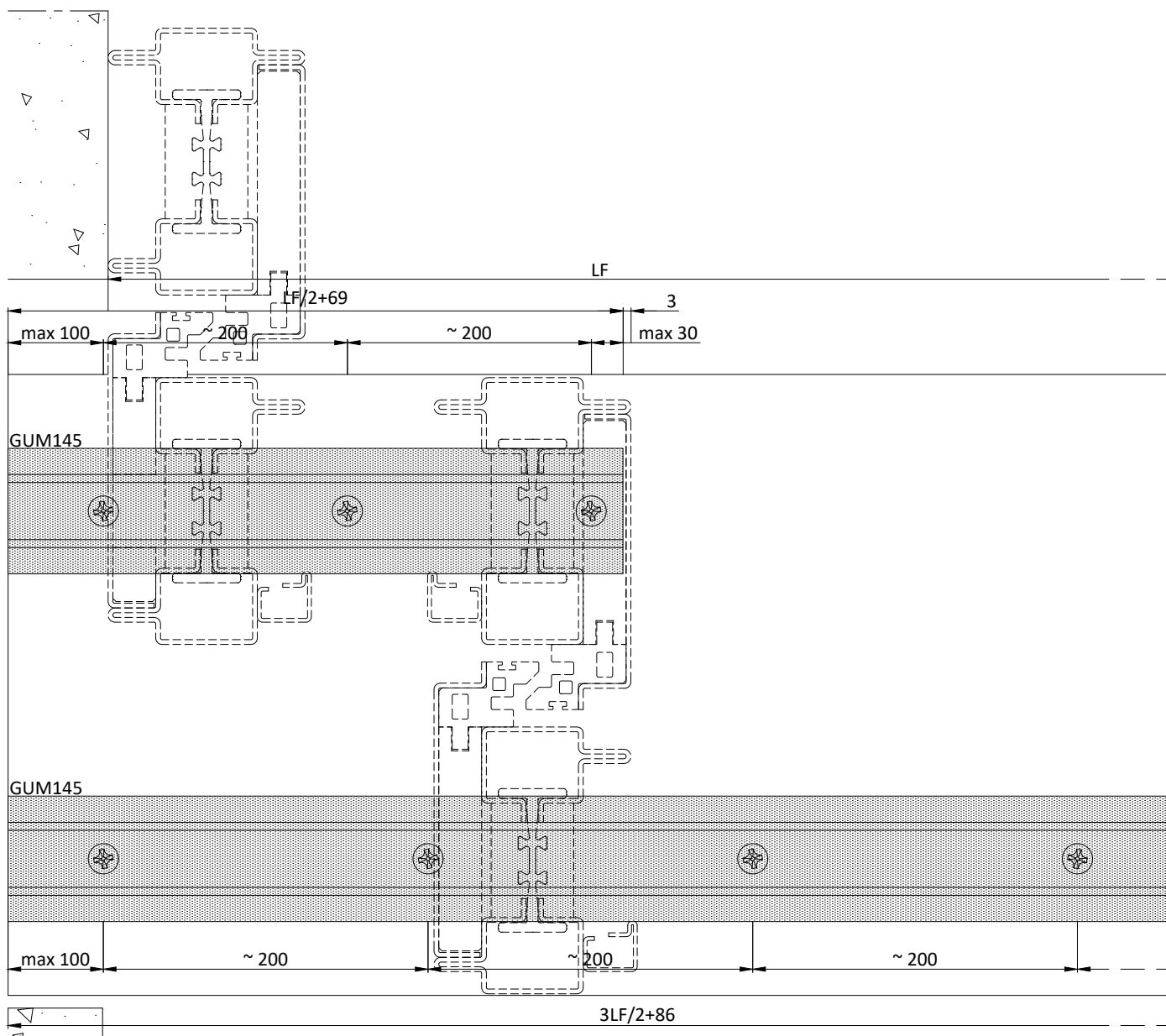

\* viti TPS 4.2x22 non comprese  
\* screws TPS 4.2x22 not supplied



Schema | Type S3

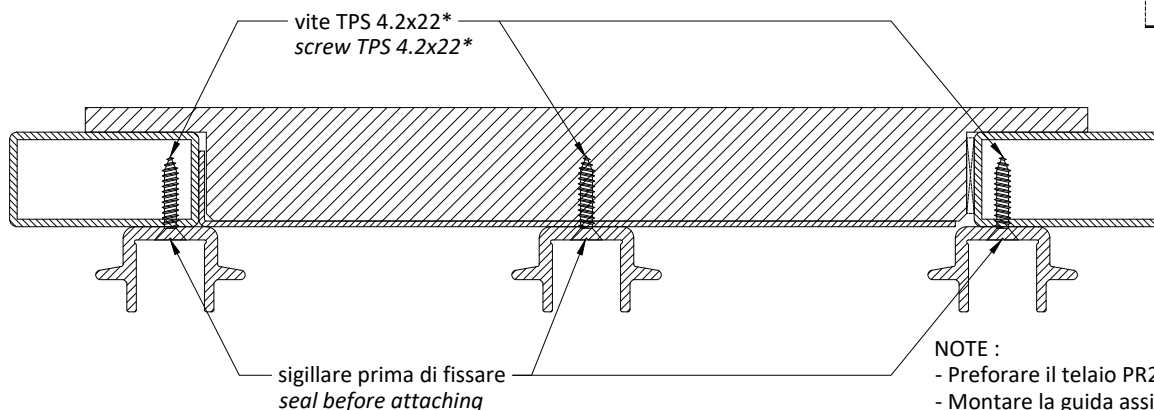
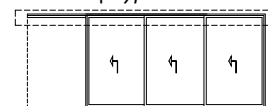

NOTE :  
 - Preforare il telaio PR2986S3 prima dell'assemblaggio  
 - Montare la guida assieme alla posa dell'anta

NOTE:  
 -Perforate frame PR2986S3 before assemblage  
 -Mount the rail when attaching the sash

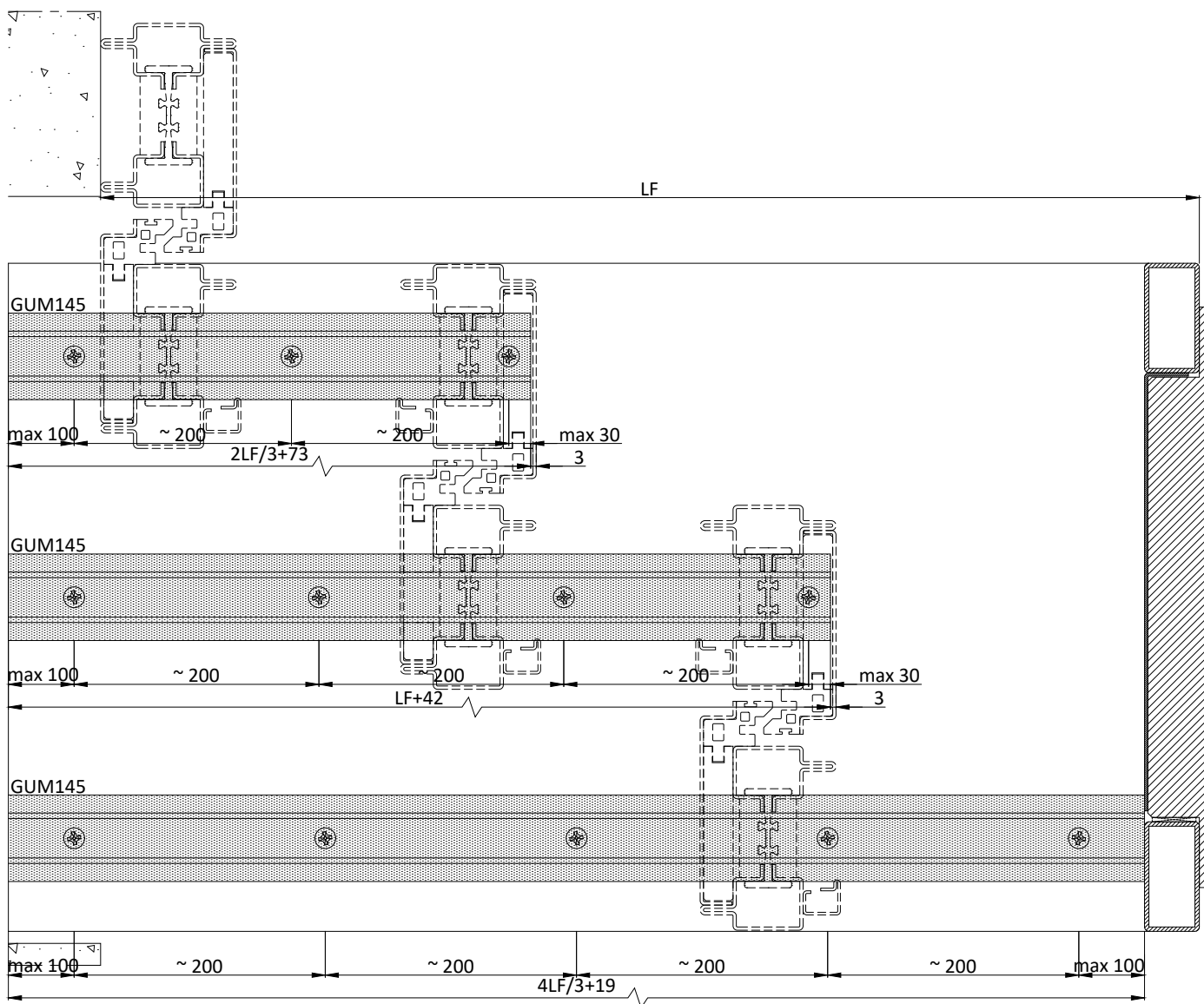

\* viti TPS 4.2x22 non comprese  
 \* screws TPS 4.2x22 not supplied



Schema | Type T3

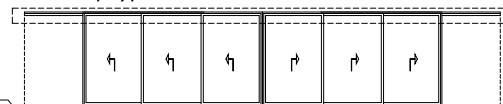
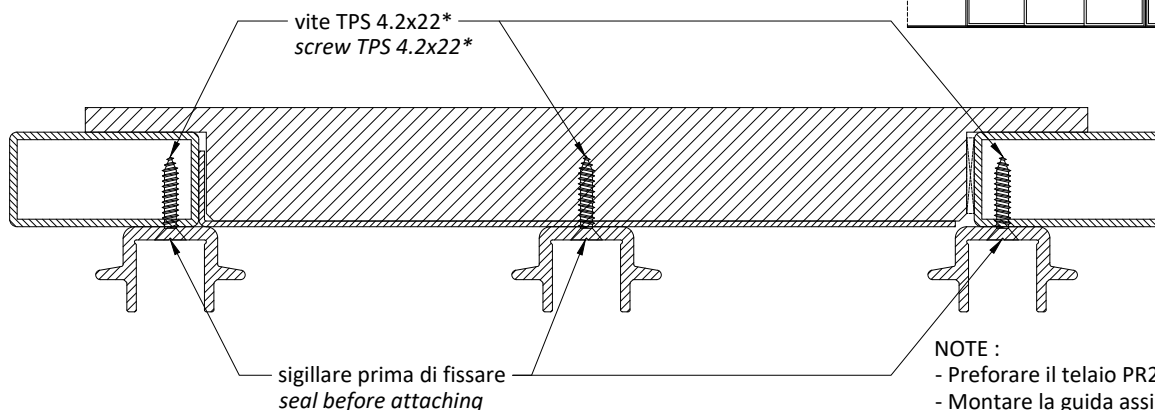

NOTE :  
 - Preforare il telaio PR2986S3 prima dell'assemblaggio  
 - Montare la guida assieme alla posa dell'anta

NOTE:  
 -Perforate frame PR2986S3 before assemblage  
 -Mount the rail when attaching the sash

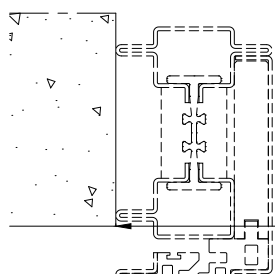

LF

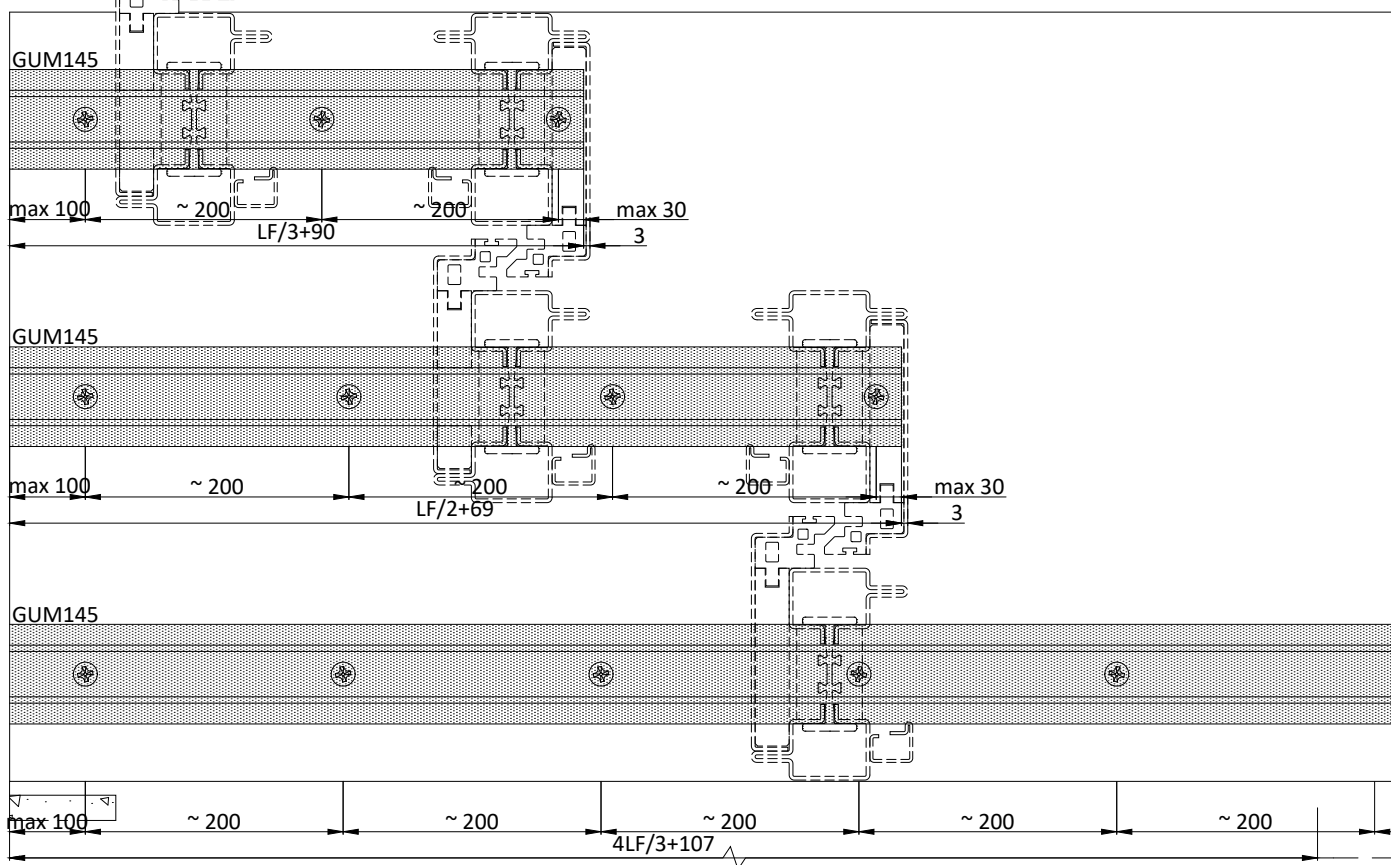

\* viti TPS 4.2x22 non comprese  
 \* screws TPS 4.2x22 not supplied

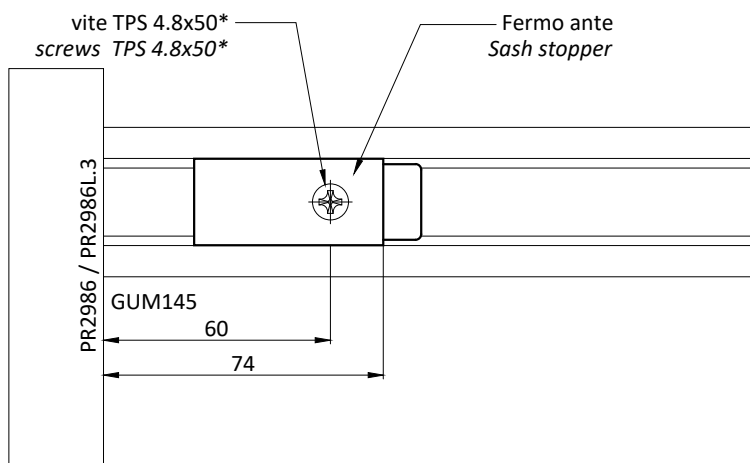
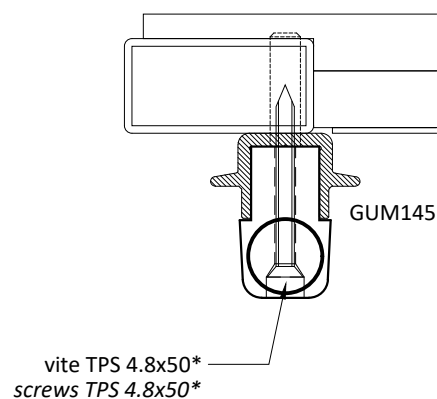
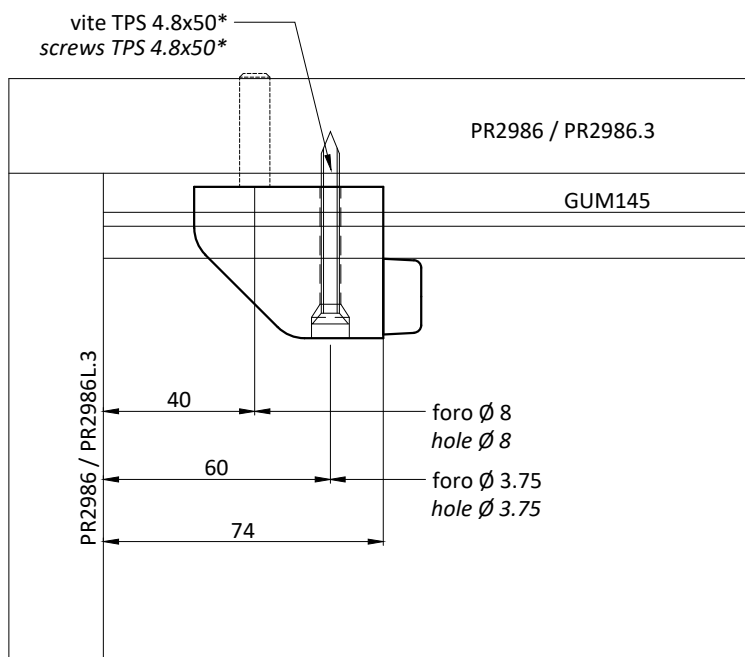
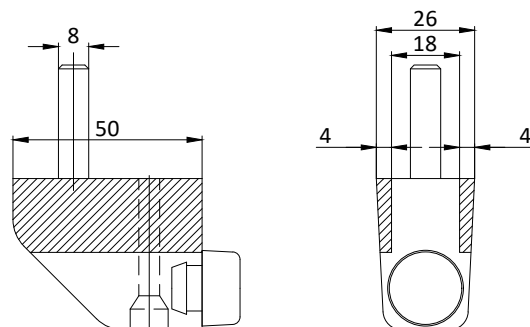
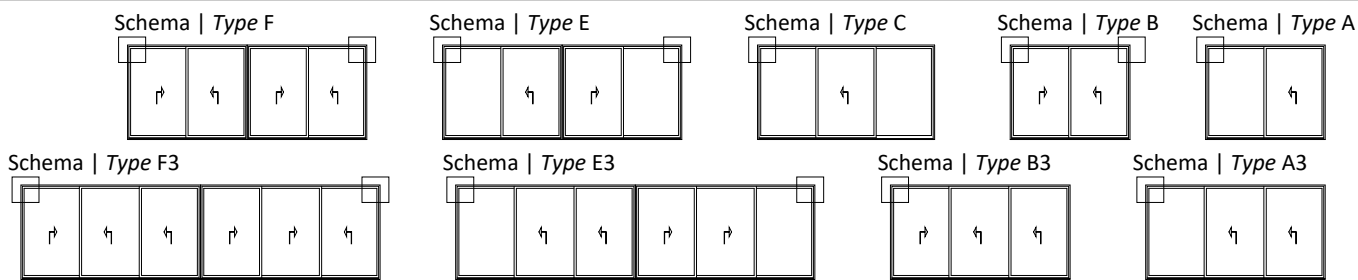

valida anche per guida singola  
valida anche per guida centrale di 3 vie  
valid also for single rail  
valid also for central guide of 3 rails

\* viti TPS 4.8x50 non comprese  
\* screws TPS 4.8x50 not supplied

Schema | Type F

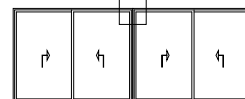

Schema | Type F3

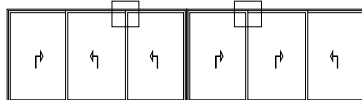

Schema | Type C3

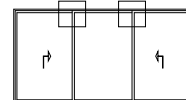

Schema | Type B3

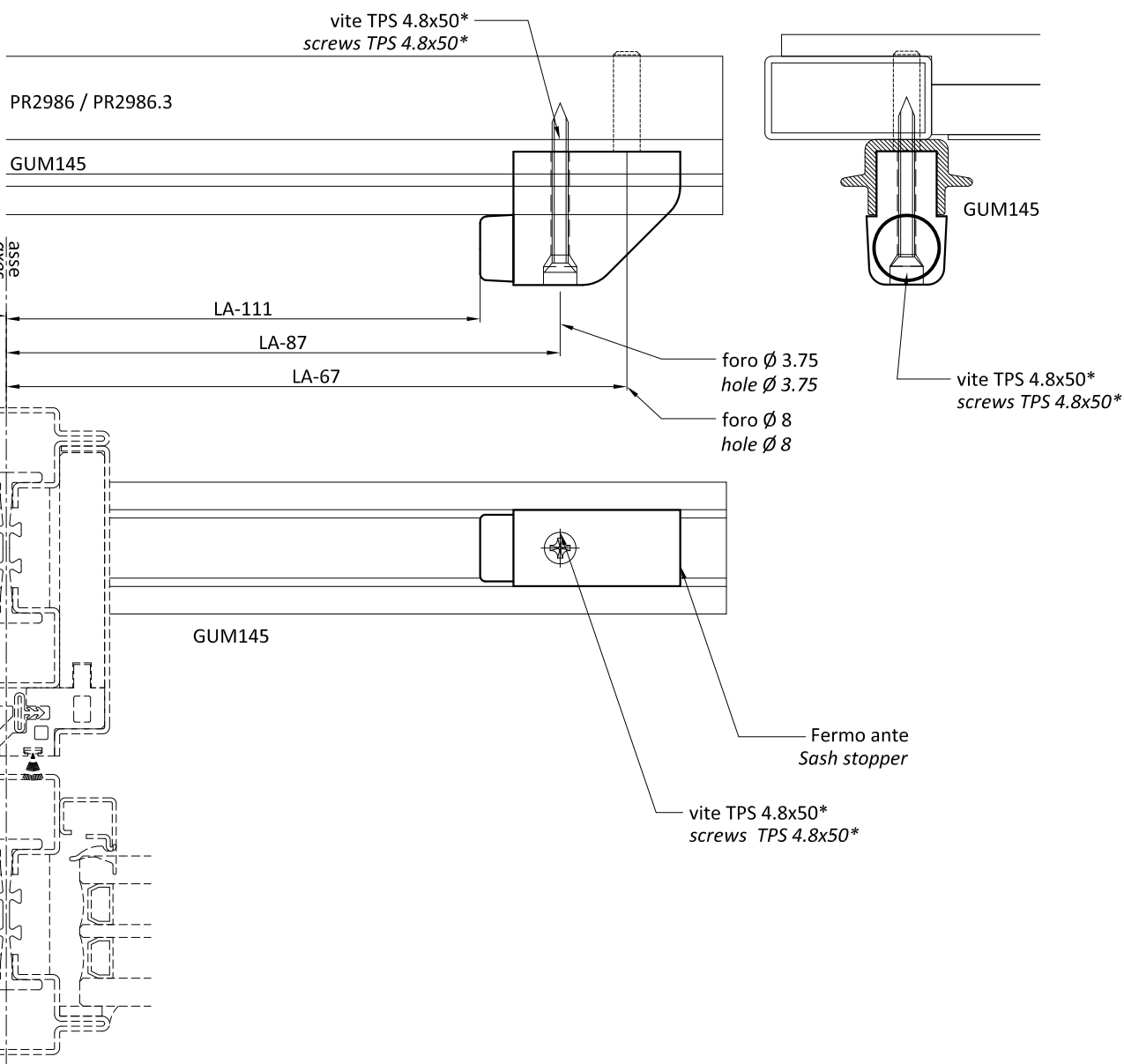
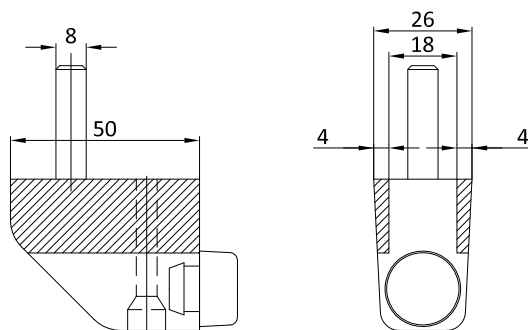
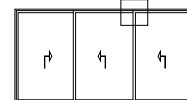

\* viti TPS 4.8x50 non comprese  
\* screws TPS 4.8x50 not supplied

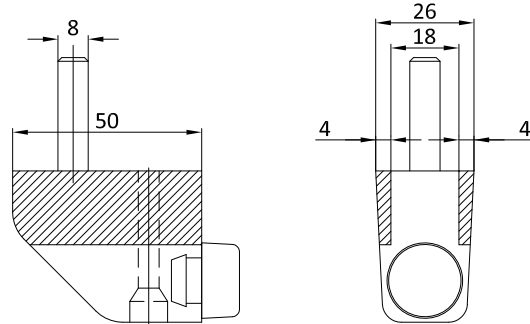
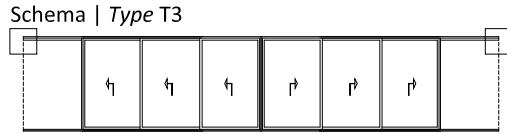
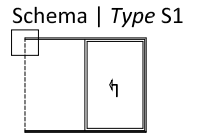
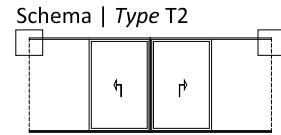
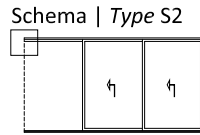
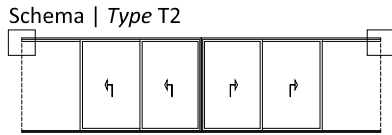

vite TPS 4.8x50\*  
screws TPS 4.8x50\*

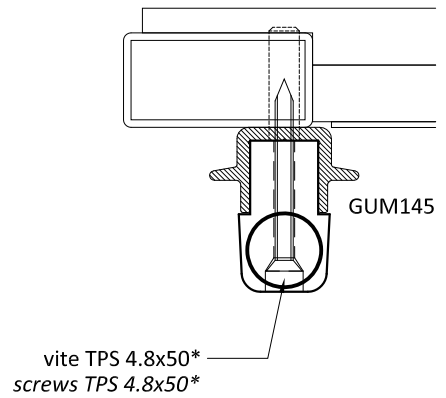
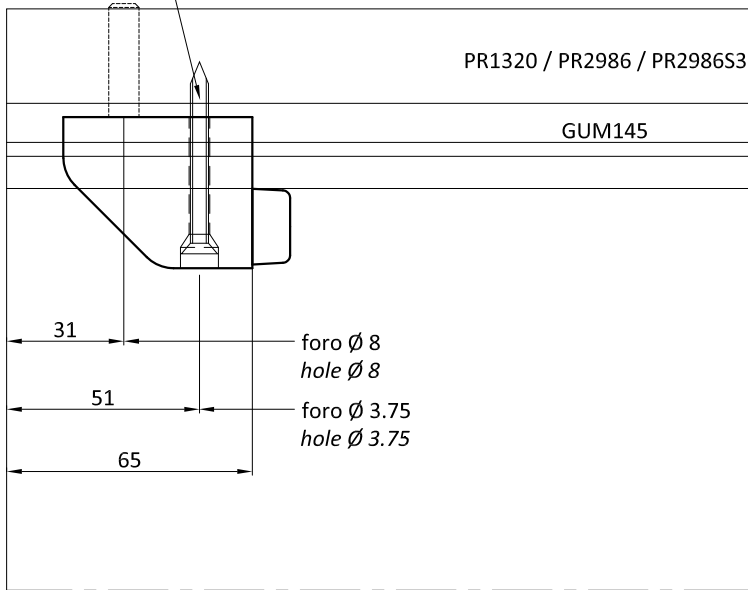

vite TPS 4.8x50\*  
screws TPS 4.8x50\*

Fermo ante  
Sash stopper

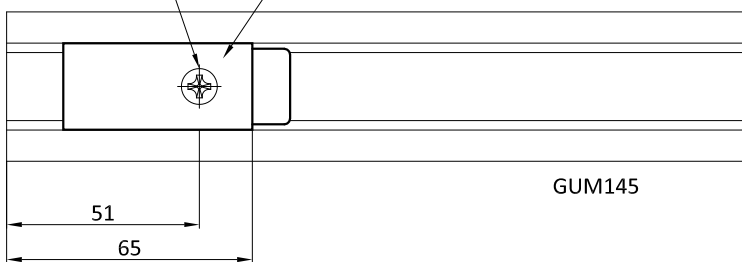

\* viti TPS 4.8x50 non comprese  
\* screws TPS 4.8x50 not supplied

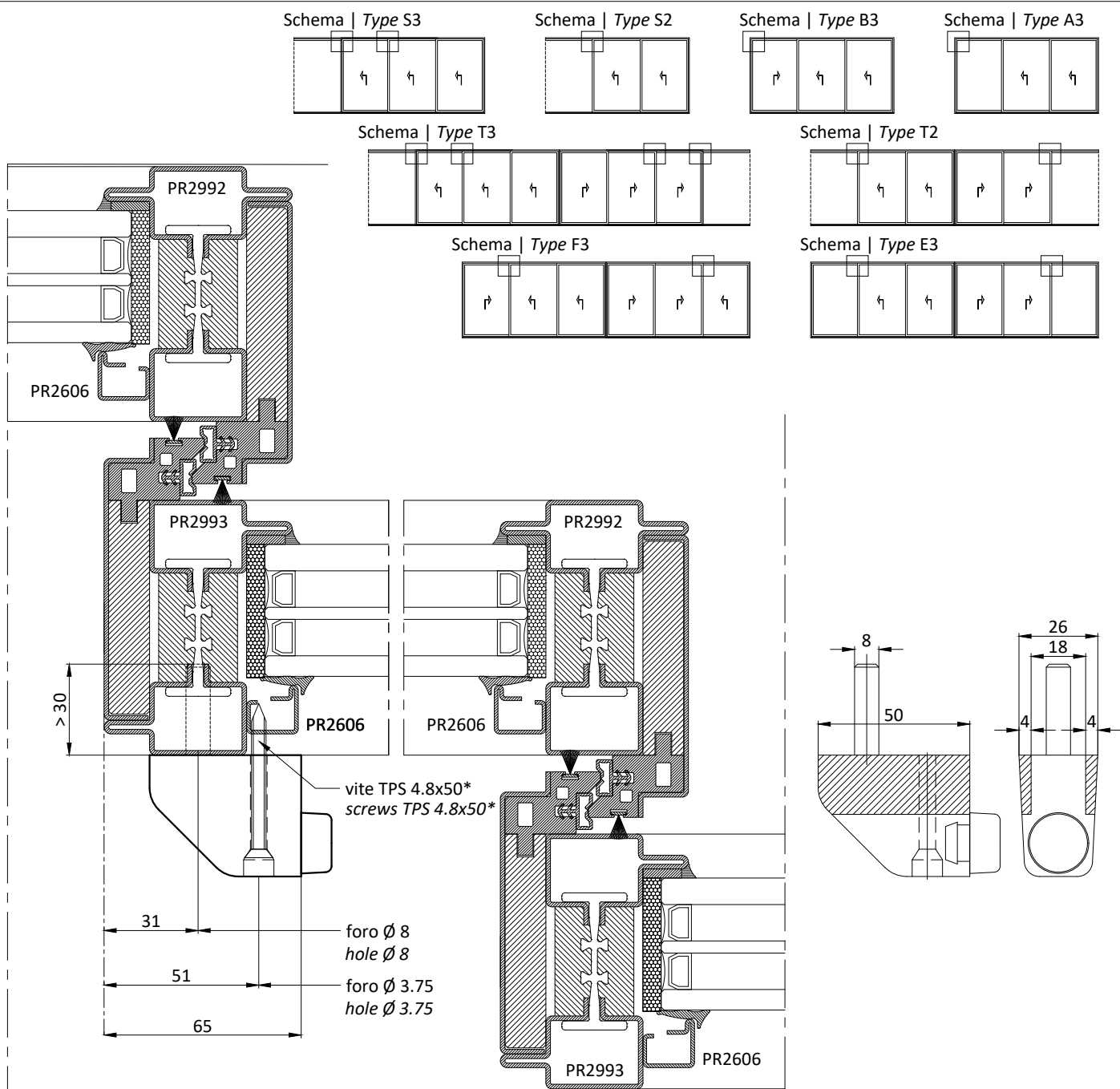

\* viti TPS 4.8x50 non comprese  
\* screws TPS 4.8x50 not supplied

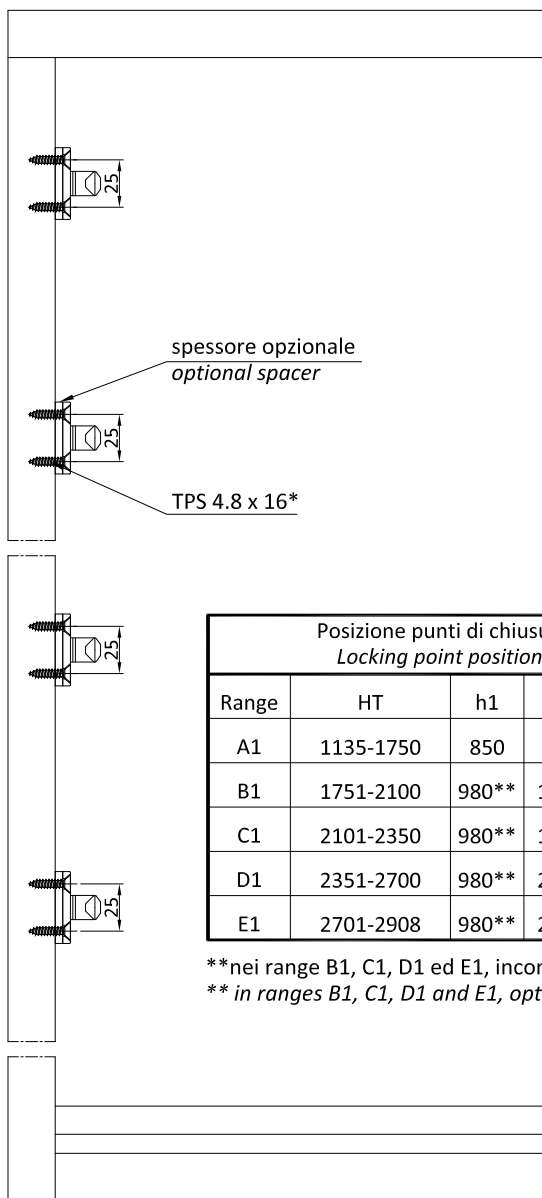
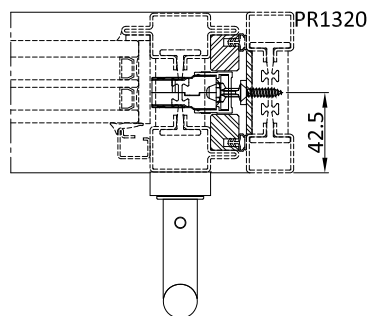
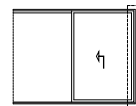

Posizione punti di chiusura Locking point position				
Range	HT	h1	h2	h3
A1	1135-1750	850	-	-
B1	1751-2100	980**	1450	-
C1	2101-2350	980**	1600	-
D1	2351-2700	980**	2000	-
E1	2701-2908	980**	2000	VAR.

\*\*nei range B1, C1, D1 ed E1, incontro h1 opzionale  
\*\* in ranges B1, C1, D1 and E1, optional locking h1

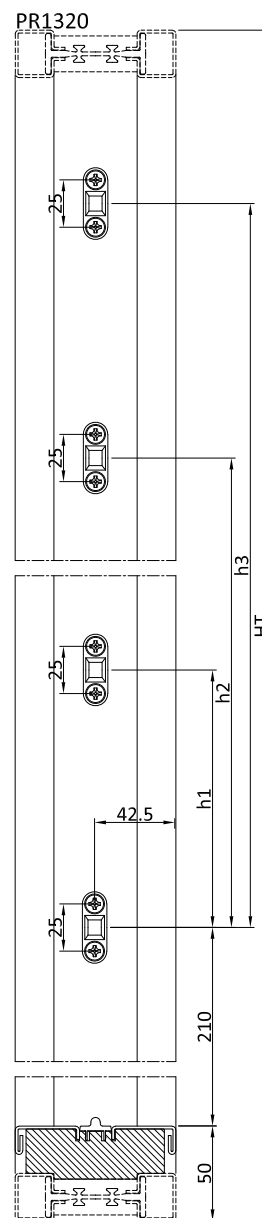

PR2981.1  
PR1320

\* viti TPS 4.8x16 non comprese  
\* screws TPS 4.8x16 not supplied

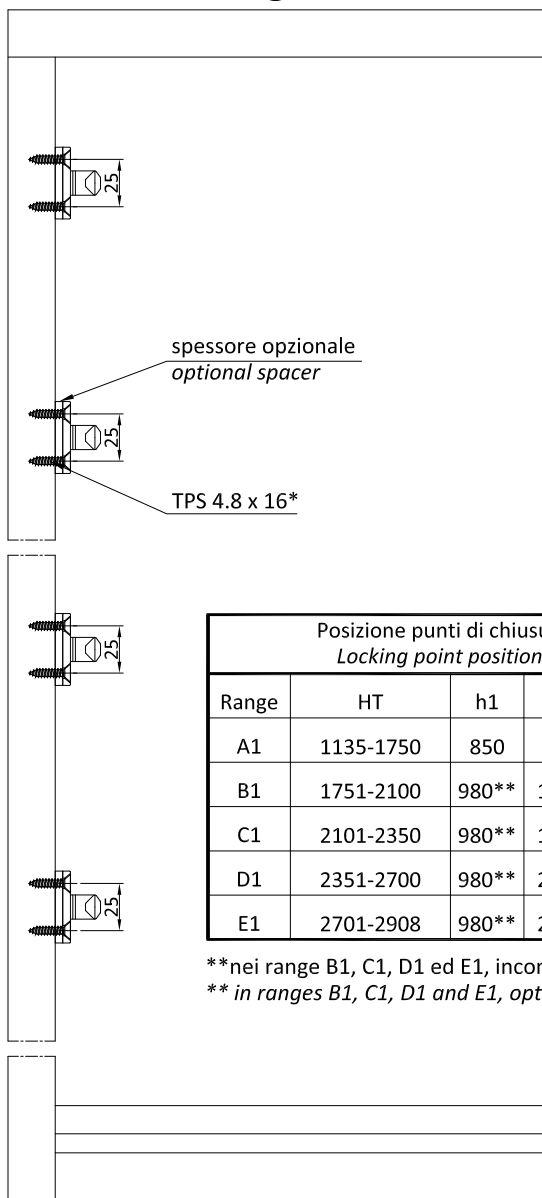
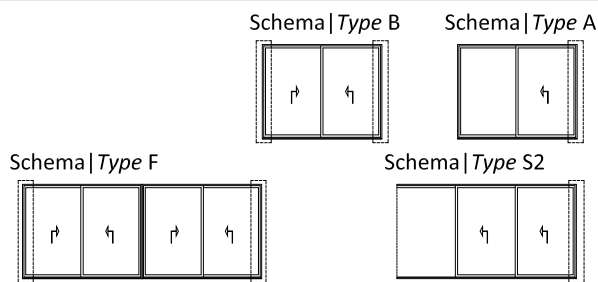
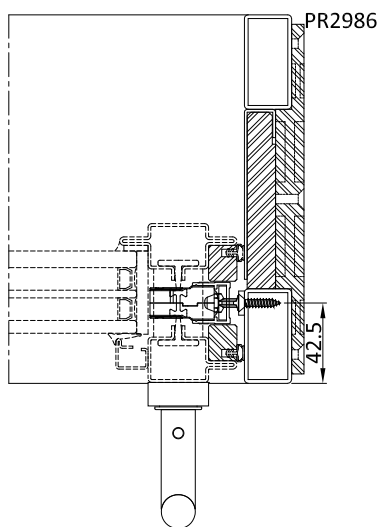

spessore opzionale  
optional spacer

TPS 4.8 x 16\*

Posizione punti di chiusura Locking point position				
Range	HT	h1	h2	h3
A1	1135-1750	850	-	-
B1	1751-2100	980**	1450	-
C1	2101-2350	980**	1600	-
D1	2351-2700	980**	2000	-
E1	2701-2908	980**	2000	VAR.

\*\*nei range B1, C1, D1 ed E1, incontro h1 opzionale  
\*\* in ranges B1, C1, D1 and E1, optional locking h1

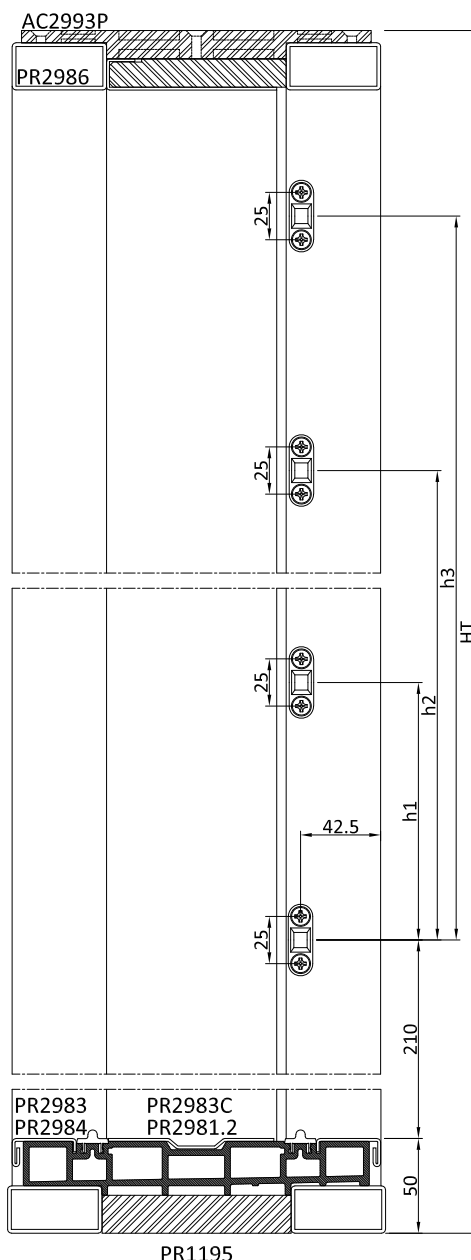

\* viti TPS 4.8x16 non comprese  
\* screws TPS 4.8x16 not supplied



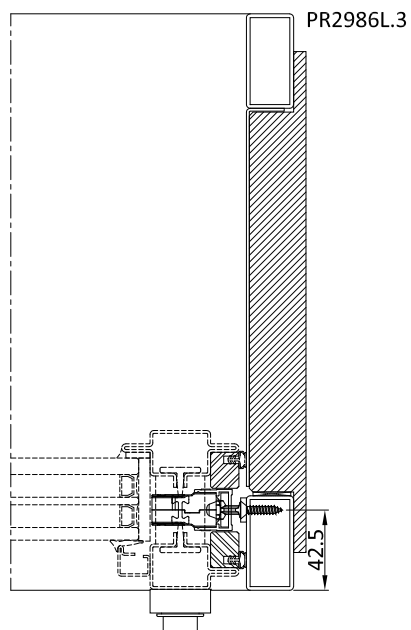

Schema | Type C3

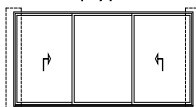

Schema | Type B3

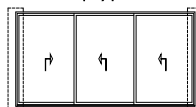

Schema | Type A3

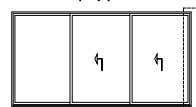

Schema | Type F3

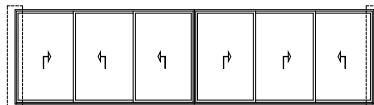

Schema | Type S3

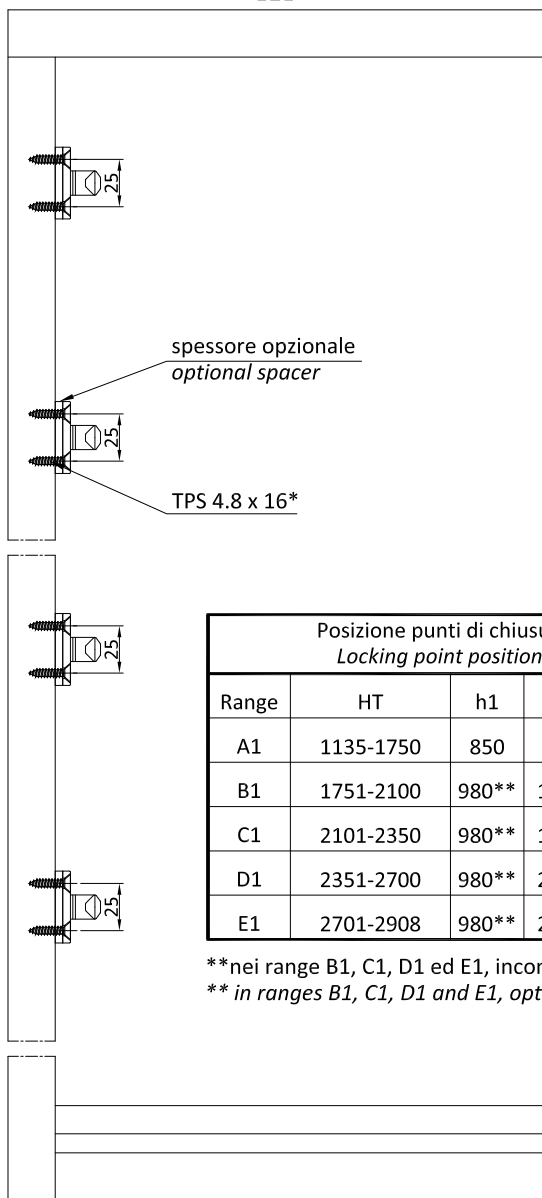
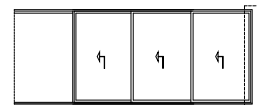

spessore opzionale  
optional spacer

TPS 4.8 x 16\*

Posizione punti di chiusura Locking point position				
Range	HT	h1	h2	h3
A1	1135-1750	850	-	-
B1	1751-2100	980**	1450	-
C1	2101-2350	980**	1600	-
D1	2351-2700	980**	2000	-
E1	2701-2908	980**	2000	VAR.

\*\*nei range B1, C1, D1 ed E1, incontro h1 opzionale  
\*\* in ranges B1, C1, D1 and E1, optional locking h1

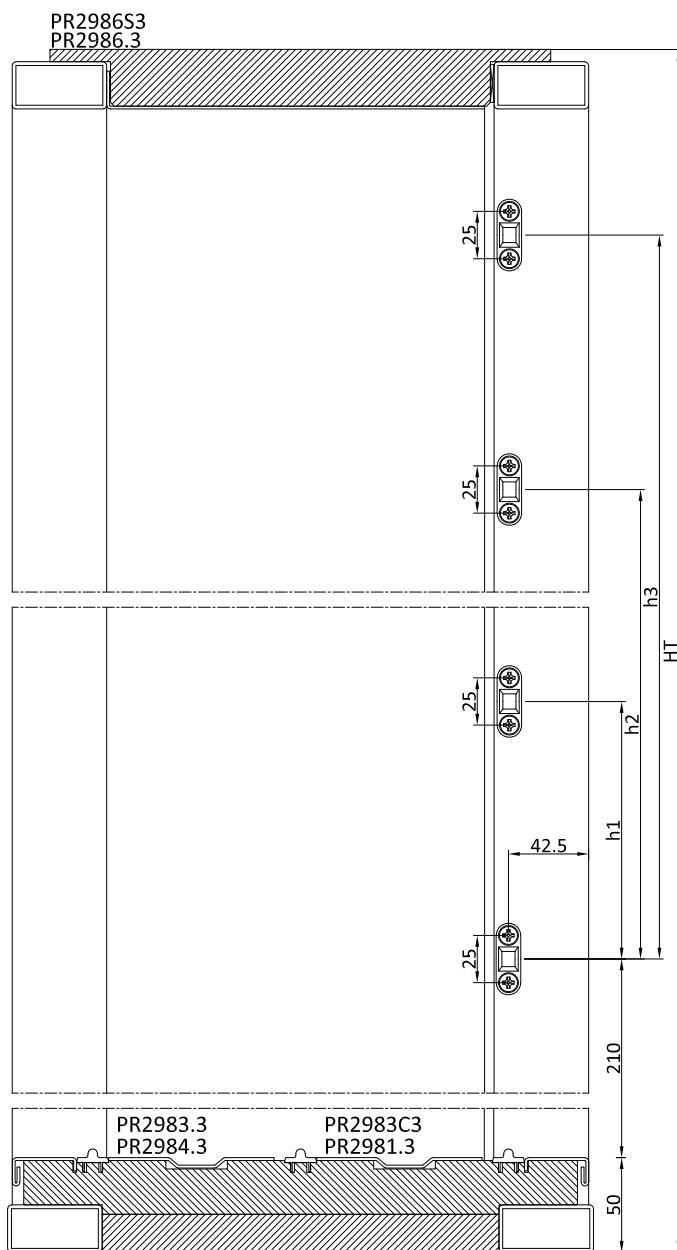

\* viti TPS 4.8x16 non comprese  
\* screws TPS 4.8x16 not supplied

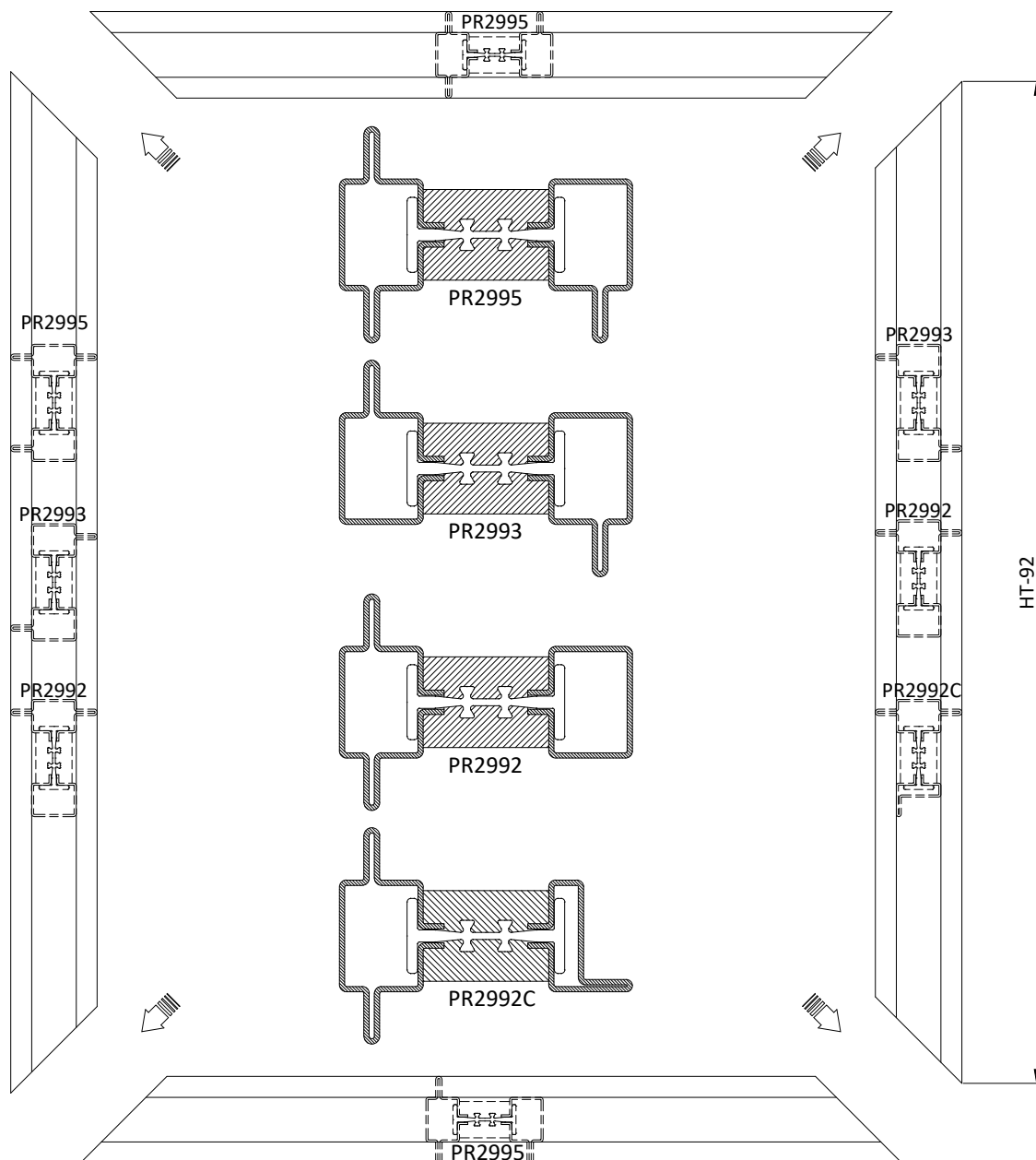
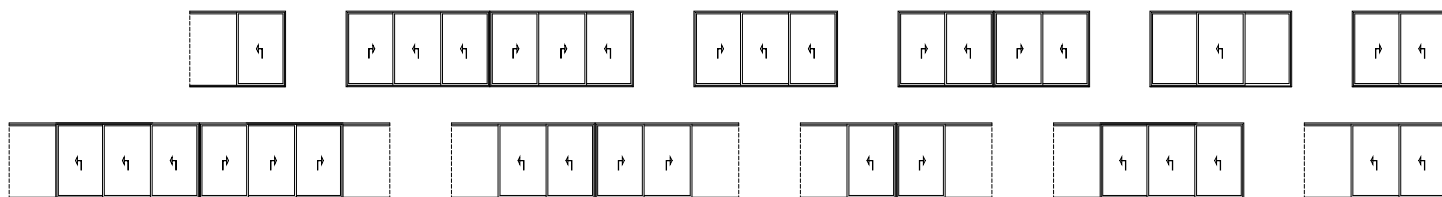

- |                                      |                                |
|--------------------------------------|--------------------------------|
| L=LT/2+2 (Schema   Type A-B)         | L=LF/2+16.5 (Schema   Type S2) |
| L=LT/3+22 (Schema   Type C-A3-B3-C3) | L=LF/3+31 (Schema   Type S3)   |
| L=LT/4+15.5 (Schema   Type E-F)      | L=LF/2-2 (Schema   Type T1)    |
| L=LT/6+31 (Schema   Type E3-F3)      | L=LF/4+30 (Schema   Type T2)   |
| L=LF-29 (Schema   Type S1)           | L=LF/6+41 (Schema   Type T3)   |

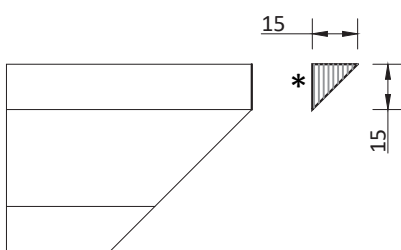
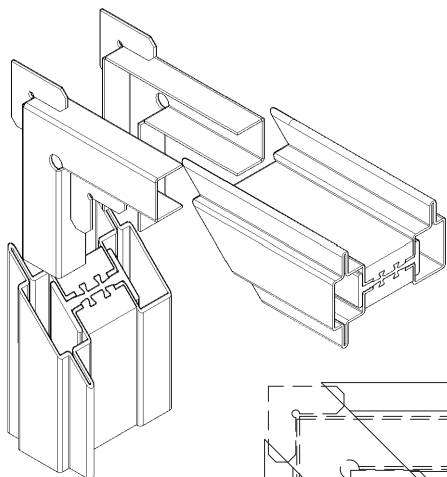
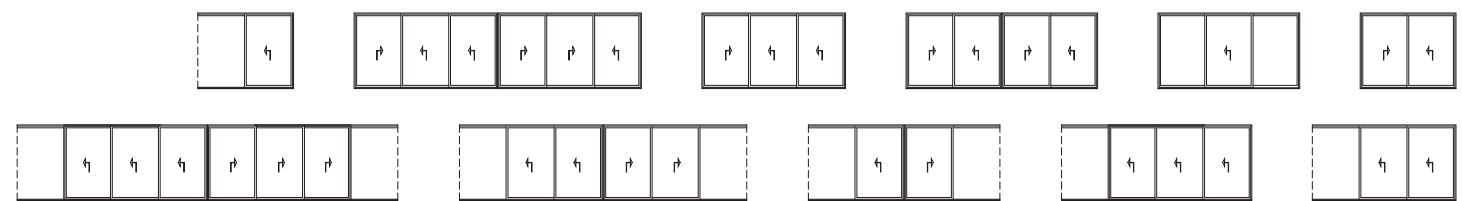

\*dopo l'assemblaggio dei profili tagliare la parte in eccesso  
after corner brackets to cut off the excess part

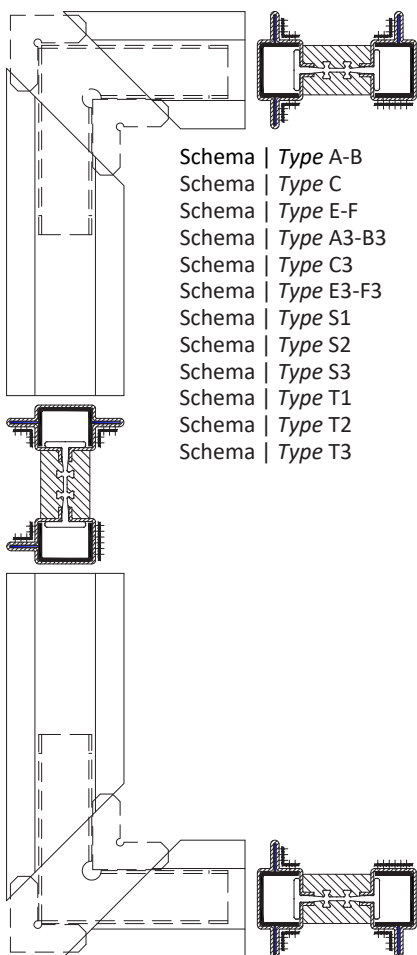
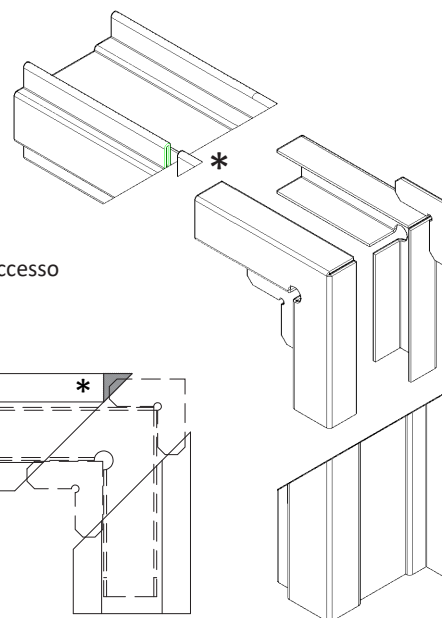

- Schema | Type A-B
- Schema | Type C
- Schema | Type E-F
- Schema | Type A3-B3
- Schema | Type C3
- Schema | Type E3-F3
- Schema | Type S1
- Schema | Type S2
- Schema | Type S3
- Schema | Type T1
- Schema | Type T2
- Schema | Type T3

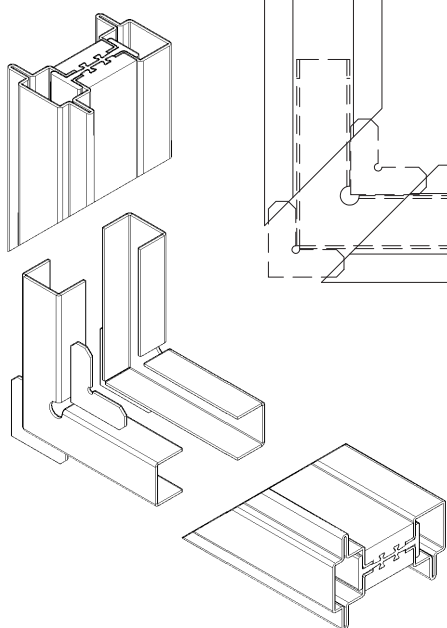
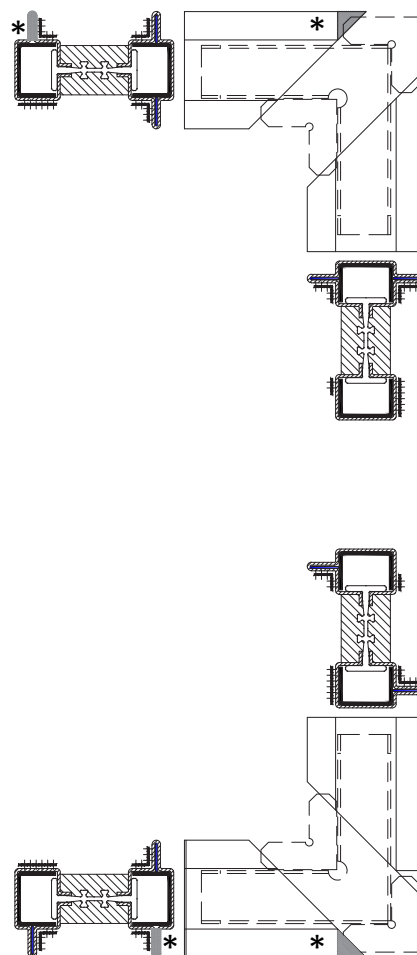

Saldare a TIG con materiale di riporto  
nelle zone indicate con++++  
TIG welding with filler material in the areas  
indicated with++++

Sigillare tutte le superfici di contatto esterne  
con silicone o SL0019  
Seal all the external contact surfaces with silicone our SL0019

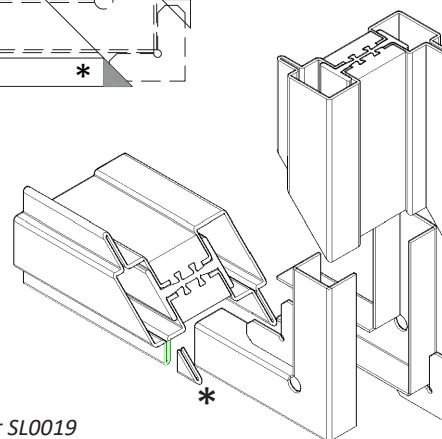

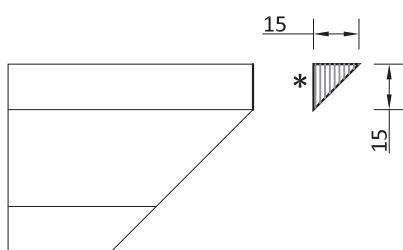
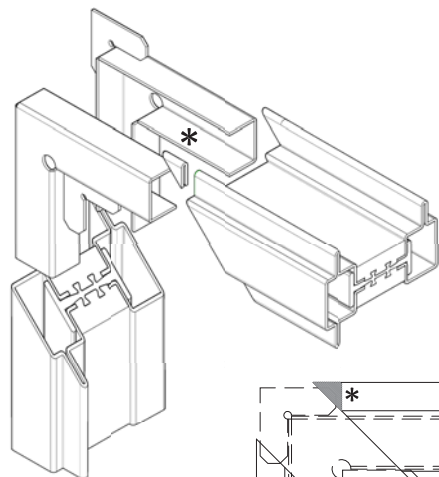
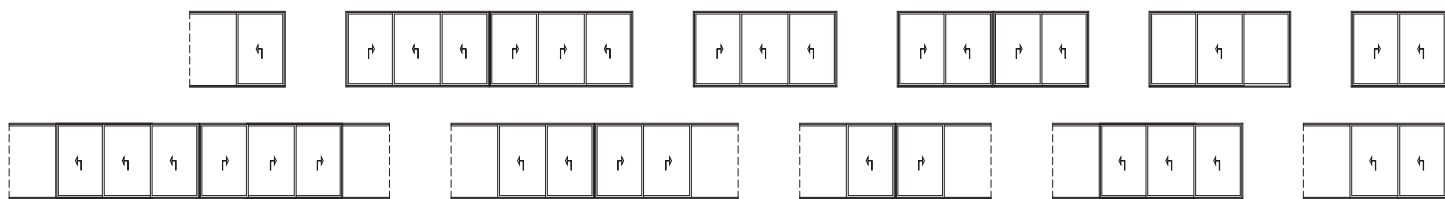

\*dopo l'assemblaggio dei profili tagliare la parte in eccesso  
after corner brackets to cut off the excess part

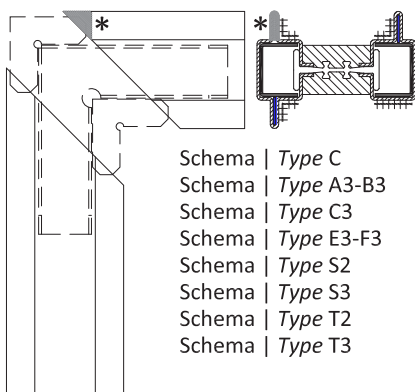
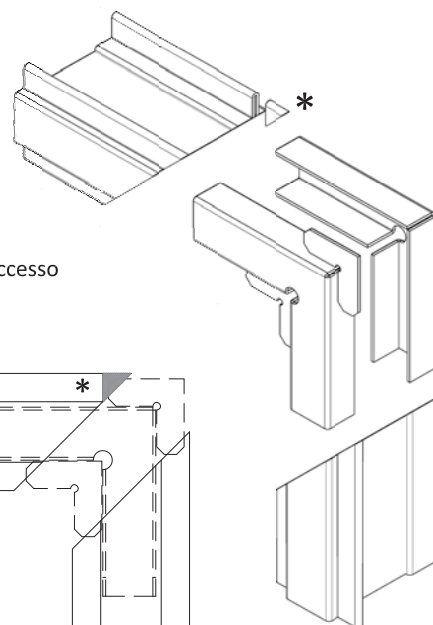

- Schema | Type C
- Schema | Type A3-B3
- Schema | Type C3
- Schema | Type E3-F3
- Schema | Type S2
- Schema | Type S3
- Schema | Type T2
- Schema | Type T3

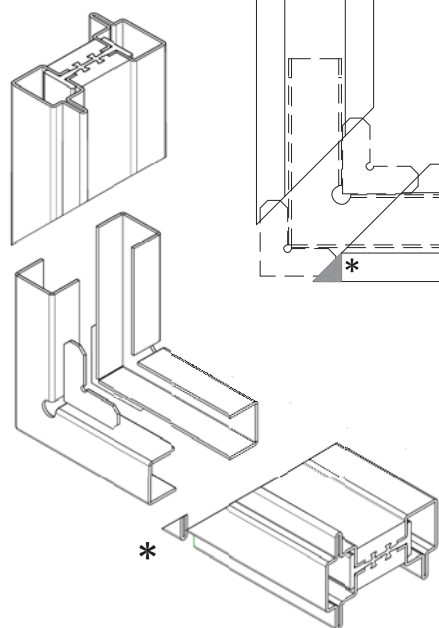
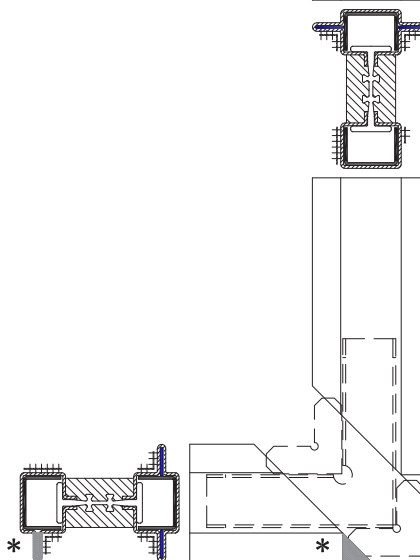
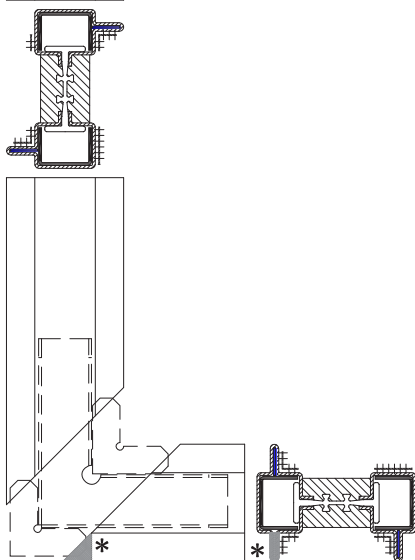
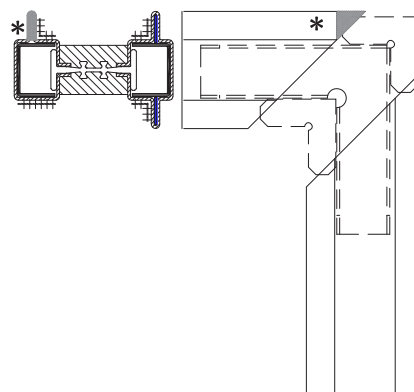

Saldare a TIG con materiale di riporto  
nelle zone indicate con++++  
TIG welding with filler material in the areas  
indicated with++++

Sigillare tutte le superfici di contatto esterne  
con silicone o SL0019  
Seal all the external contact surfaces with silicone our SL0019

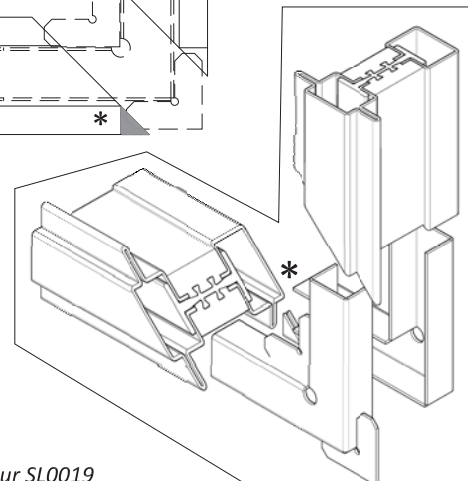

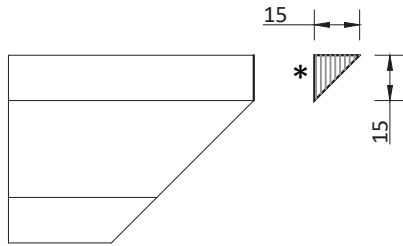
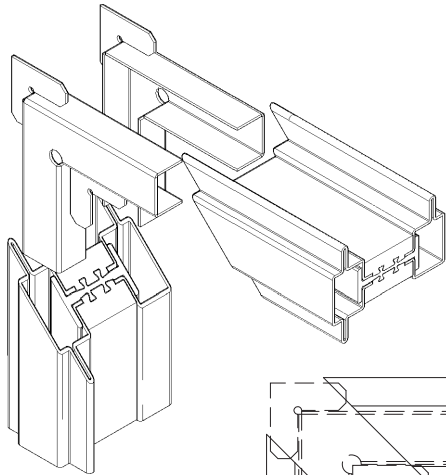
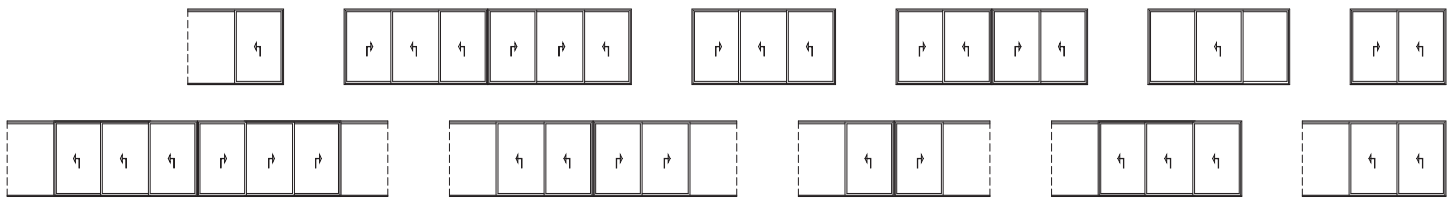

\*dopo l'assemblaggio dei profili tagliare la parte in eccesso  
after corner brackets to cut off the excess part

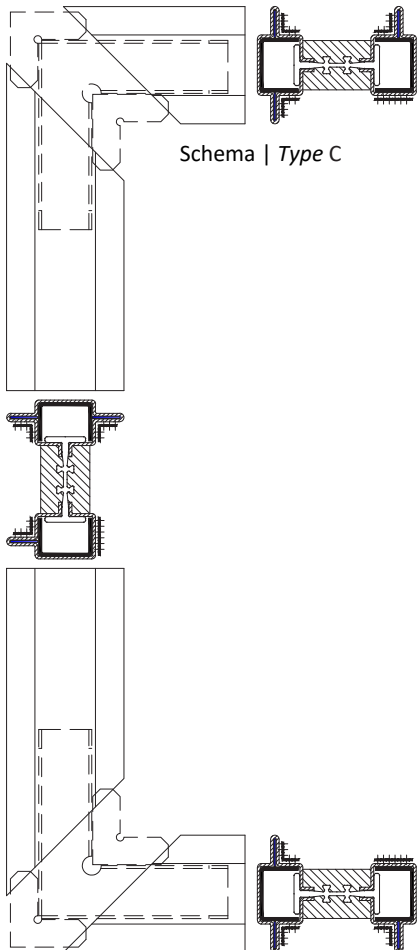
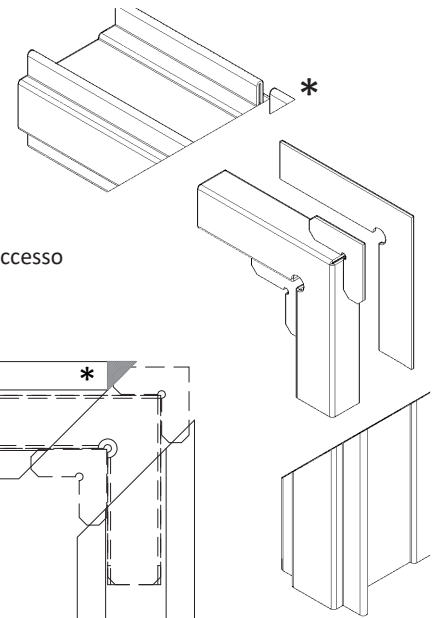

Schema | Type C

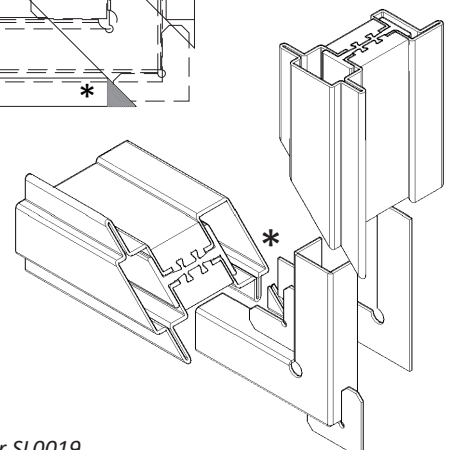
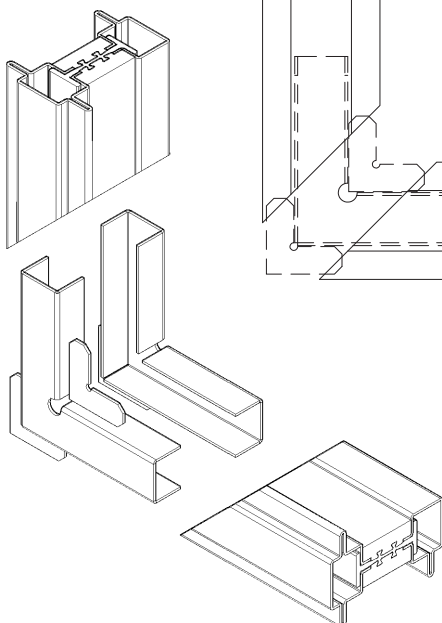
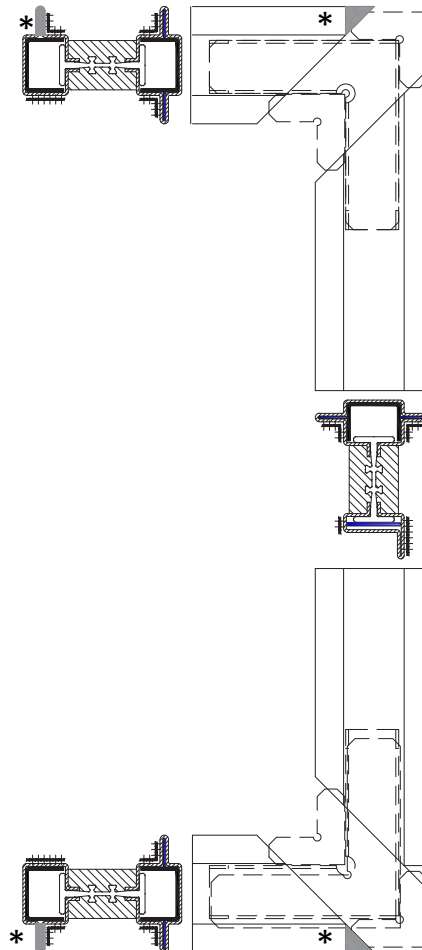

Saldare a TIG con materiale di riporto  
nelle zone indicate con++++  
TIG welding with filler material in the areas  
indicated with++++

Sigillare tutte le superfici di contatto esterne  
con silicone o SL0019  
Seal all the external contact surfaces with silicone our SL0019

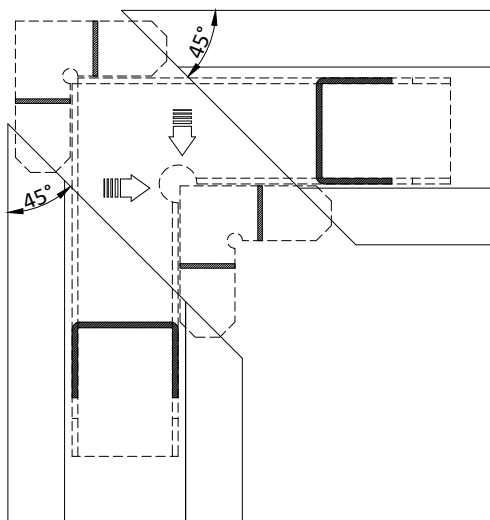
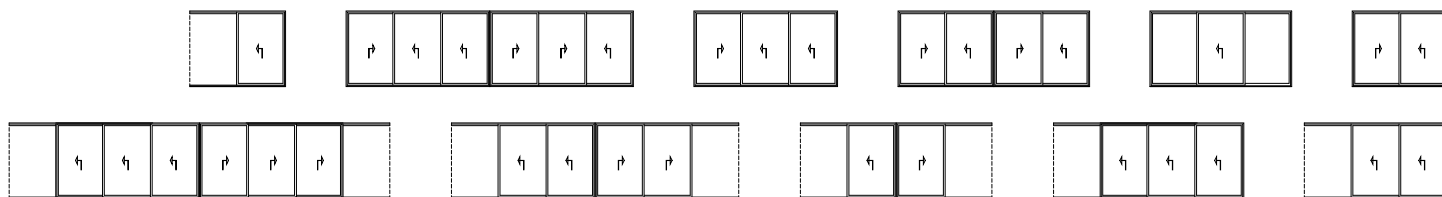

- 1) inserire la squadretta
- 2) siliconare nelle zone indicate
- 3) accostare i profili
- 4) procedere con la saldatura (vedasi pagine successive)

- 1) insert the bracket
- 2) seal in the specified areas
- 3) align the profiles
- 4) weld (see following pages)

siliconare o SL0019 | silicone or SL0019   
 punti di saldatura | welding points   
 saldatura tipo | example of welding

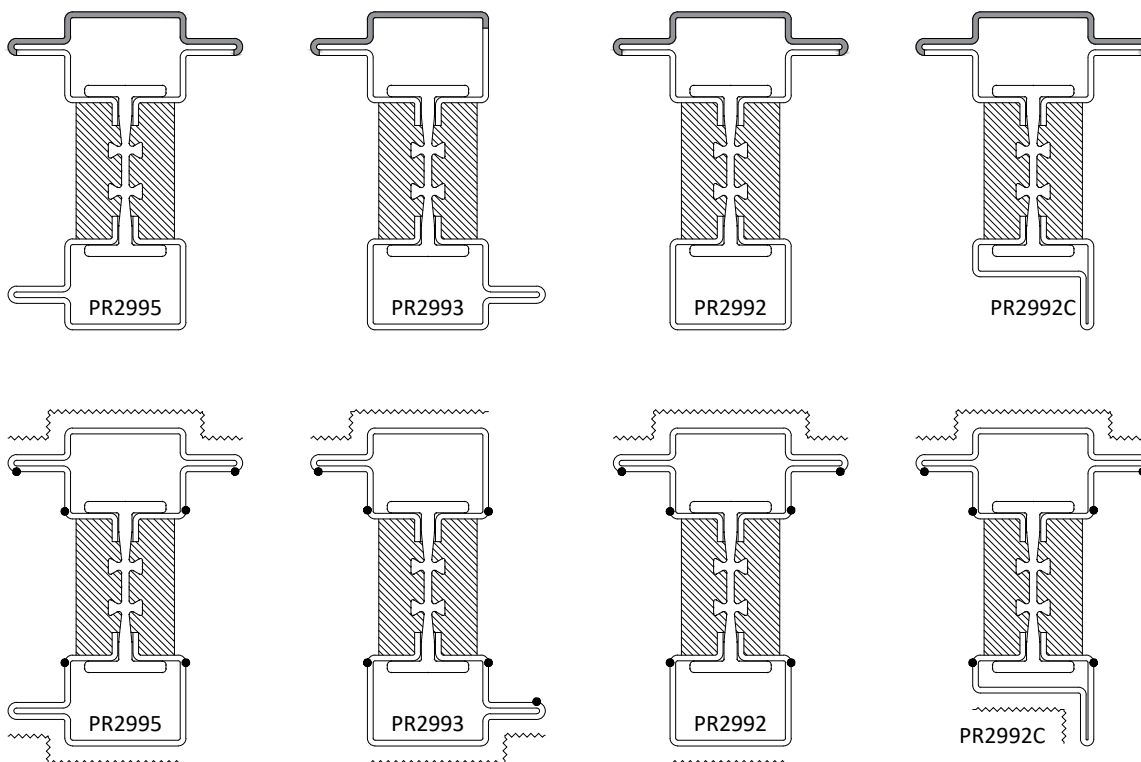

Sigillare con silicone o sigillante a freddo SL0019 nelle zone evidenziate (sempre lato esterno profilo)  
 Seal with silicone or cold-working sealant SL0019 in the areas marked (always on the outer side of the profile)

Profili | Profiles

Prospetto | View  
Vista interna | Internal view

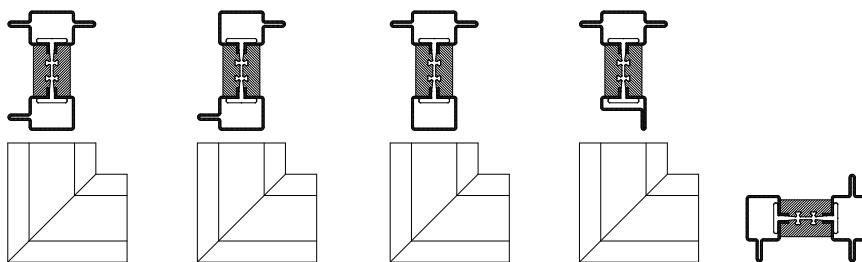

Schema | Type A-B

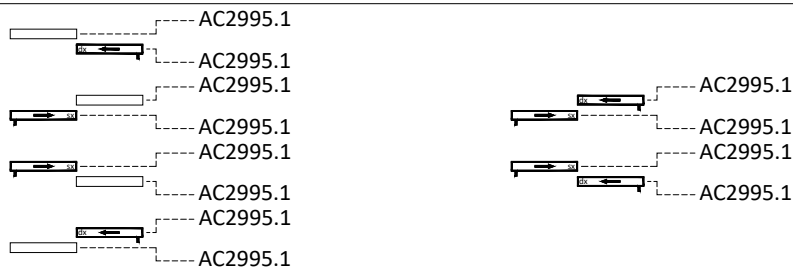
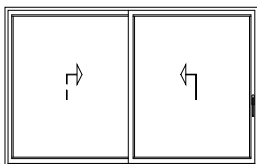

Schema | Type C

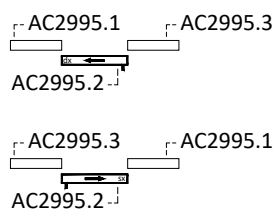
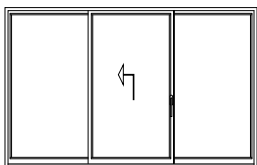

Schema | Type E-F

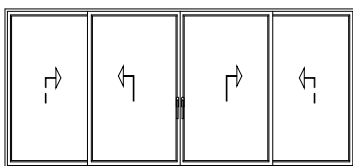

Schema | Type A3-B3

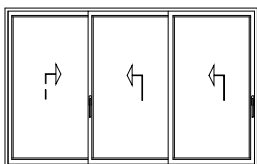

Schema | Type C3

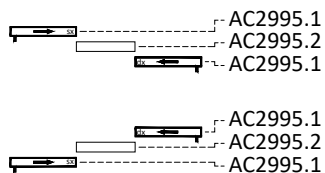
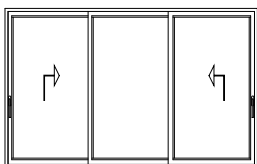

Schema | Type E3-F3

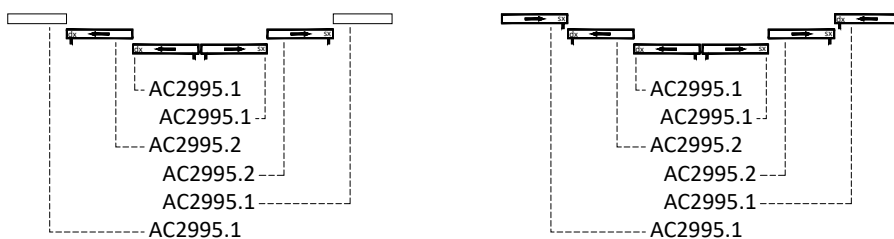
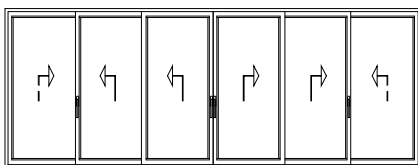

Profili | Profiles

Prospetto | View  
Vista interna | Internal view

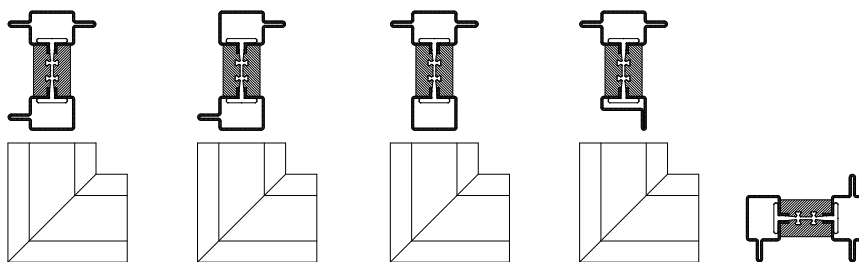

Schema | Type S1

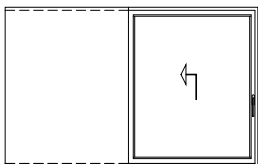

AC2995.1

AC2995.1

Schema | Type S2

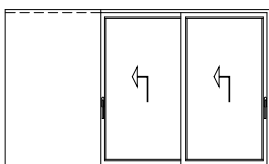

AC2995.2

AC2995.1

AC2995.2

AC2995.1

Schema | Type S3

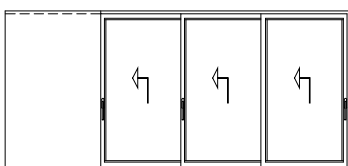

AC2995.2

AC2995.2

AC2995.1

AC2995.2

AC2995.2

AC2995.1

Schema | Type T1

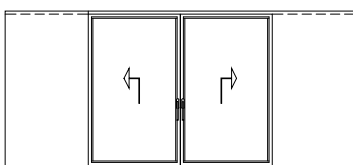

AC2995.1

AC2995.1

Schema | Type T2

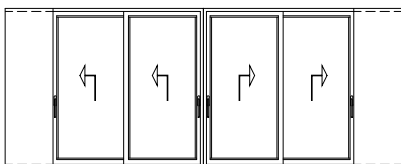

AC2995.1

AC2995.1

AC2995.2

AC2995.2

Schema | Type T3

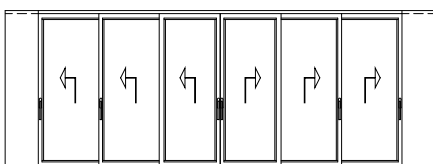

AC2995.1

AC2995.1

AC2995.2

AC2995.2

AC2995.2

AC2995.2



Fissaggio rinforzi parte superiore anta apribile | Fixing upper reinforcements opening sash

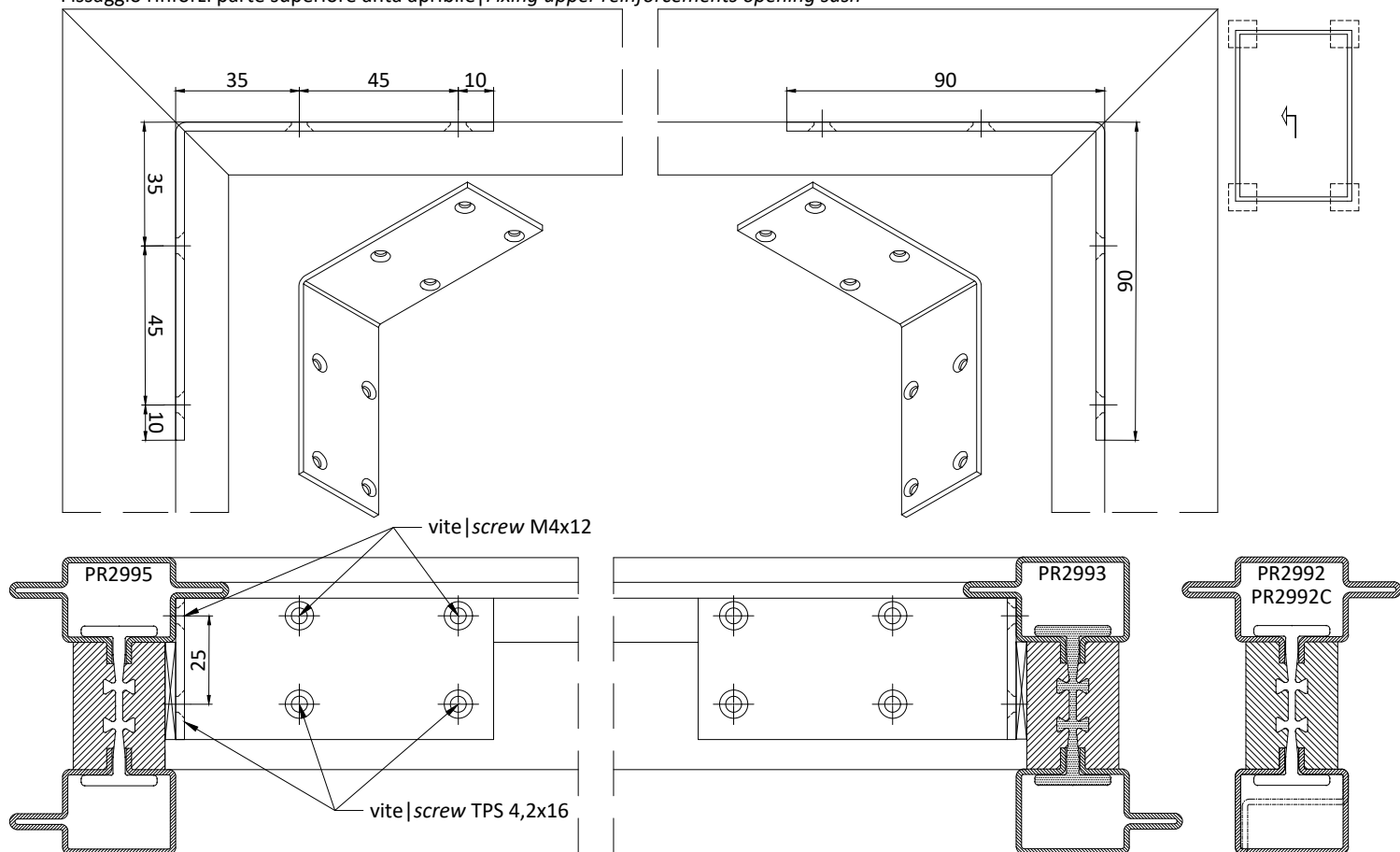

Fissaggio rinforzi parte inferiore anta apribile | Fixing lower reinforcements opening sash

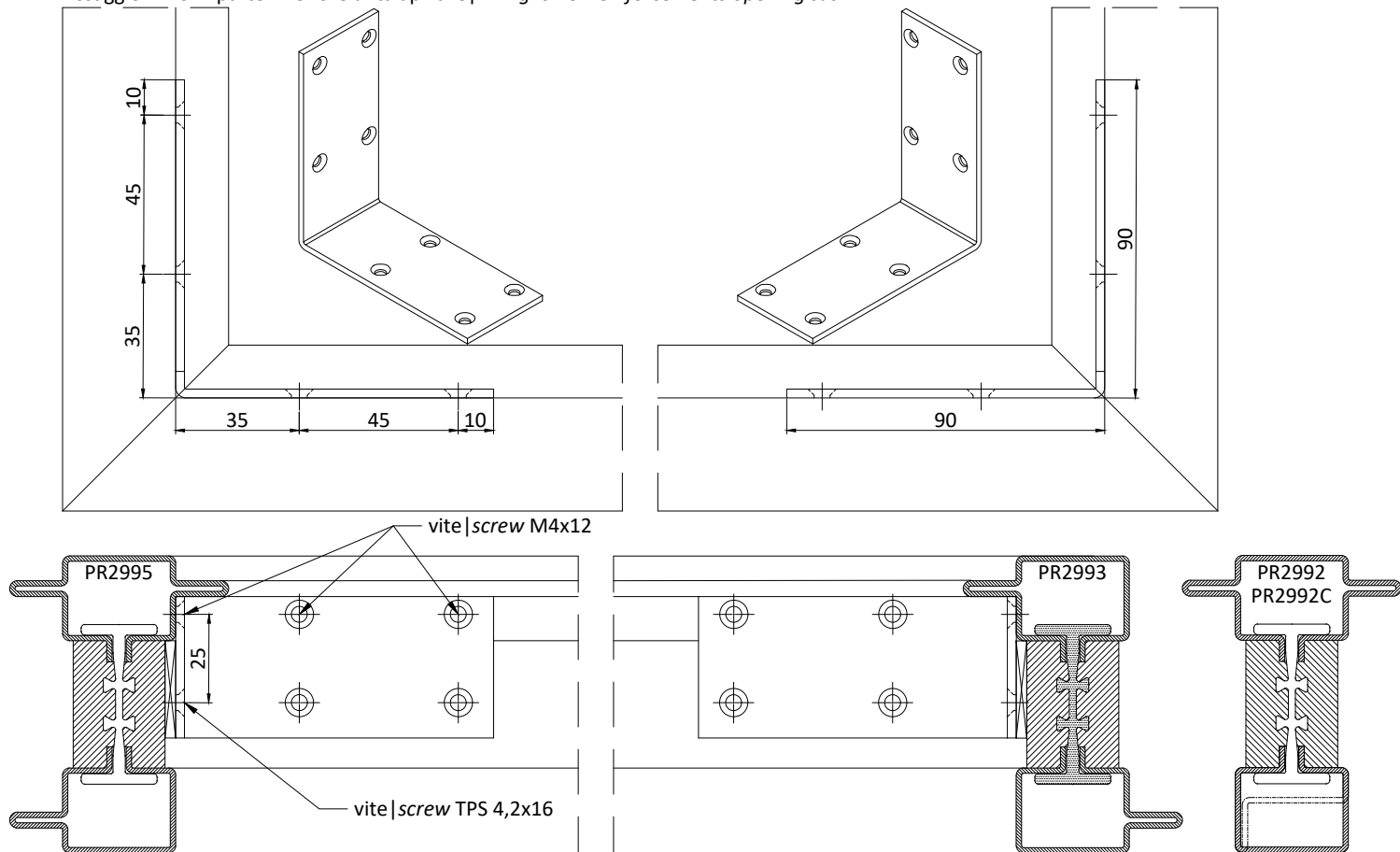

\* viti non comprese | screws not supplied

Schema | Type S2, T2

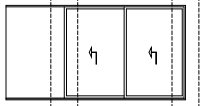

Schema | Type S1, T1

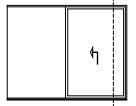

Schema | Type E, F

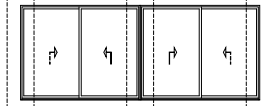

Schema | Type C

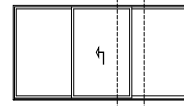

Schema | Type A, B

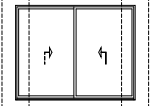

Schema | Type S3, T3

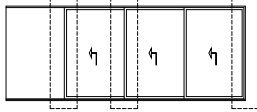

Schema | Type E3, F3

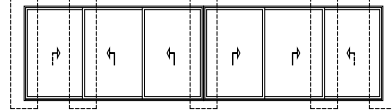

Schema | Type C3

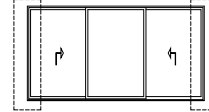

Schema | Type A3, B3

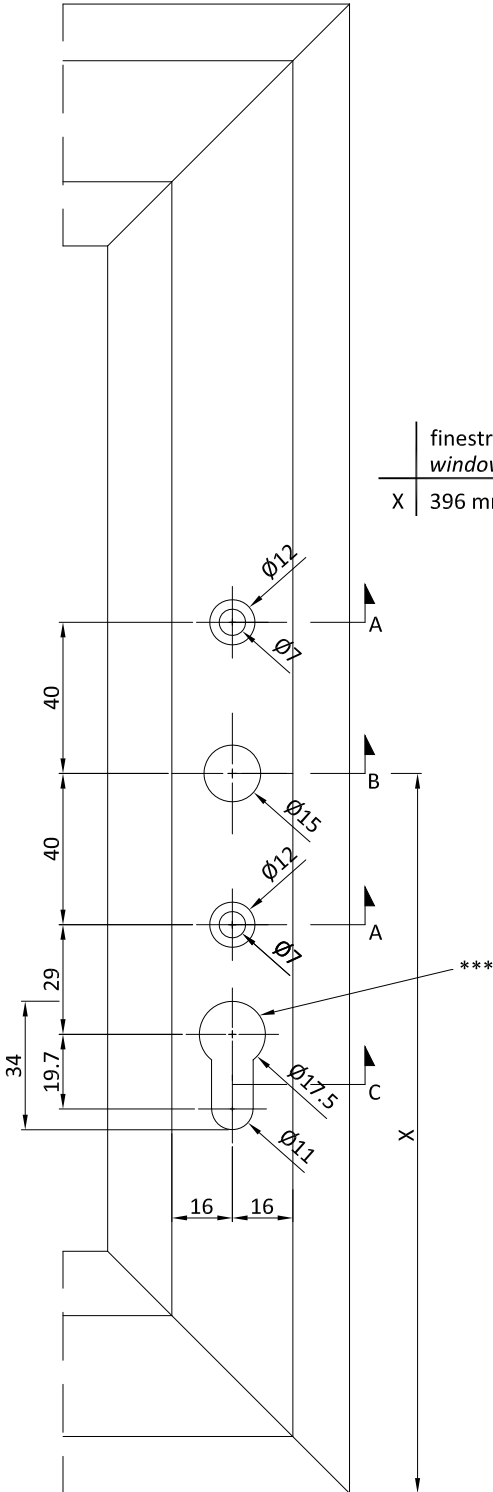
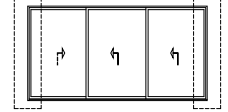

	finestra window	porta door
X	396 mm	996 mm

sezione | section A

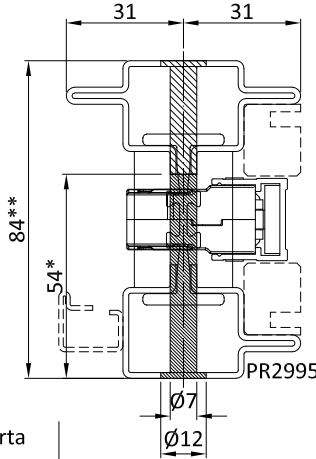

sezione | section A

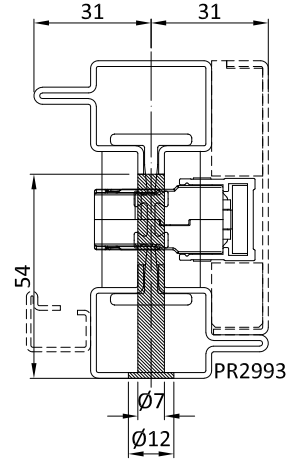

sezione | section B

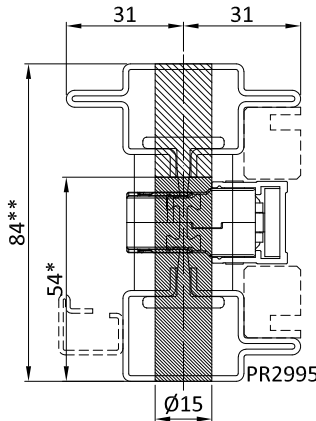

sezione | section B

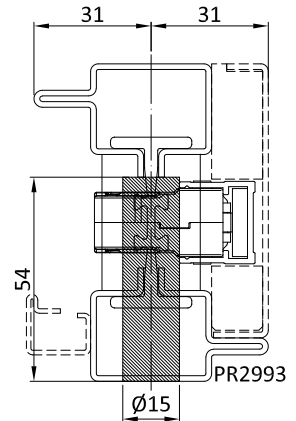

sezione | section C

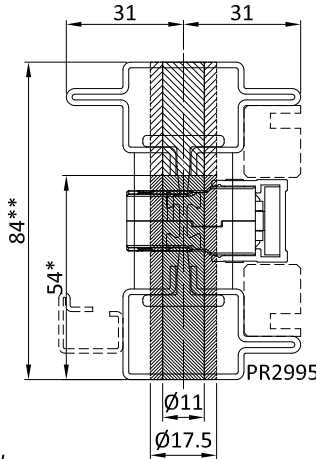

sezione | section C

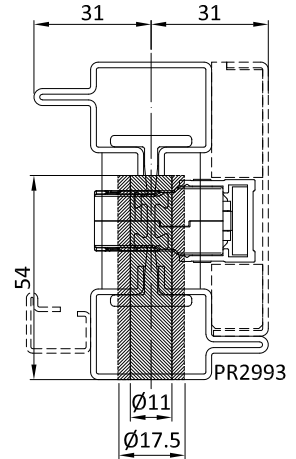

\* lavorazione con maniglione singolo | processing with single handle

\*\* lavorazione con maniglione doppio | processing with double handle

\*\*\* solo per | only for ACV222Y-ACV223Y-ACV225Y-ACV232Y-ACV233Y-ACV255Y



Schema | Type S2, T2

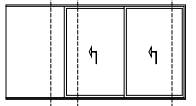

Schema | Type S1, T1

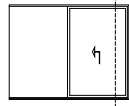

Schema | Type E, F

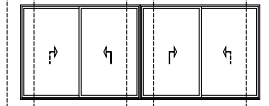

Schema | Type C

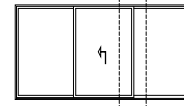

Schema | Type A, B

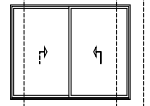

Schema | Type S3, T3

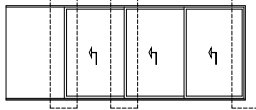

Schema | Type E3, F3

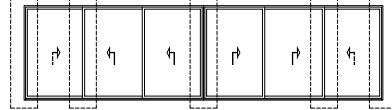

Schema | Type C3

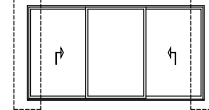

Schema | Type A3, B3

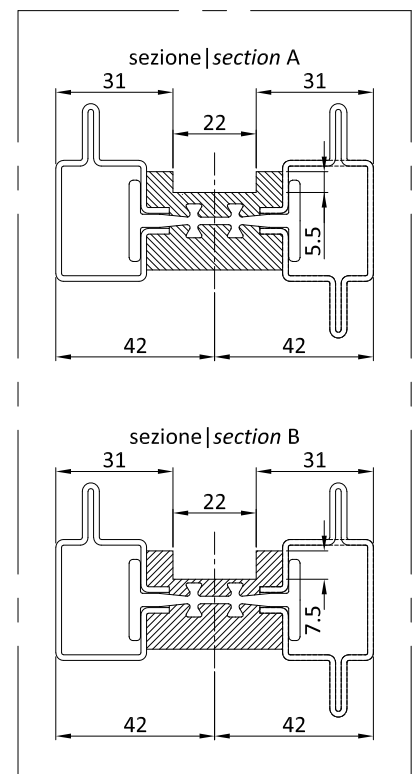
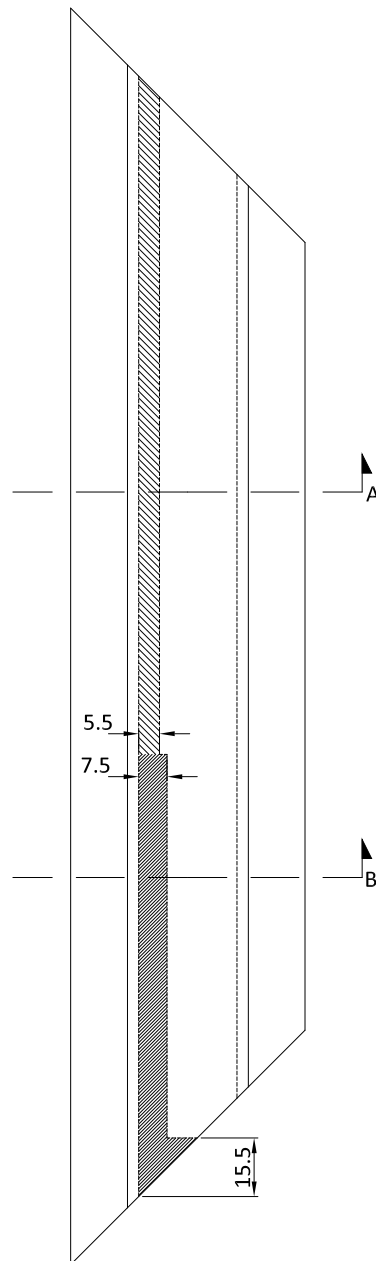
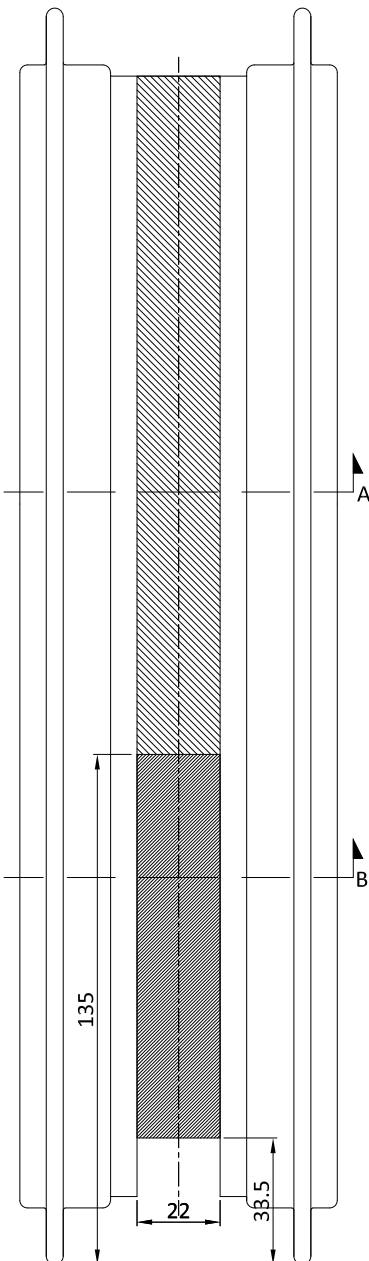
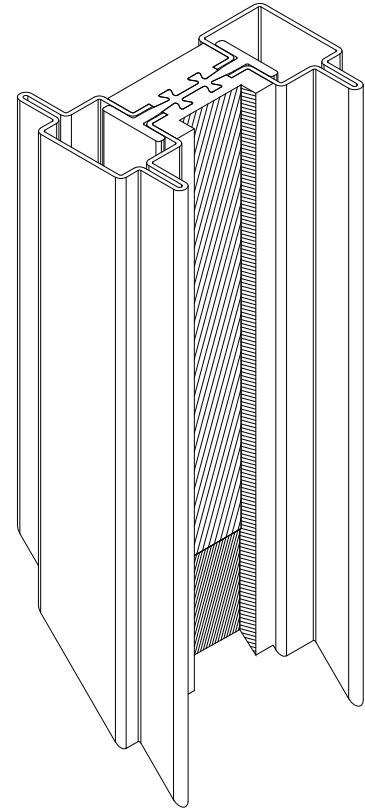
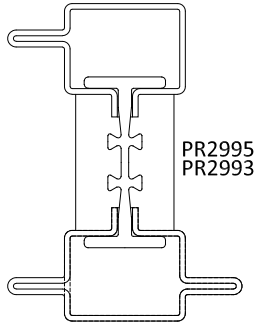
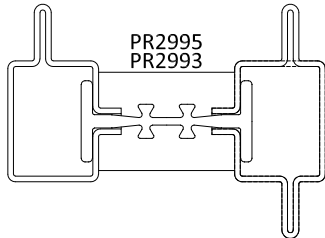
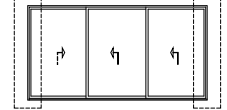

Schema | Type S2, T2

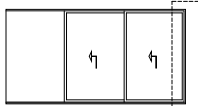

Schema | Type S1, T1

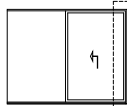

Schema | Type E, F

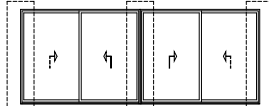

Schema | Type C

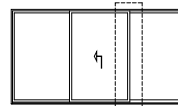

Schema | Type A, B

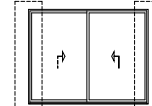

Schema | Type S3, T3

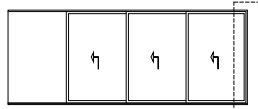

Schema | Type E3, F3

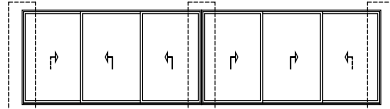

Schema | Type C3

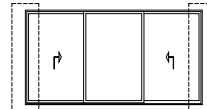

Schema | Type A3, B3

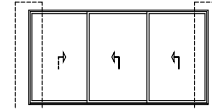

vista esterna | external view

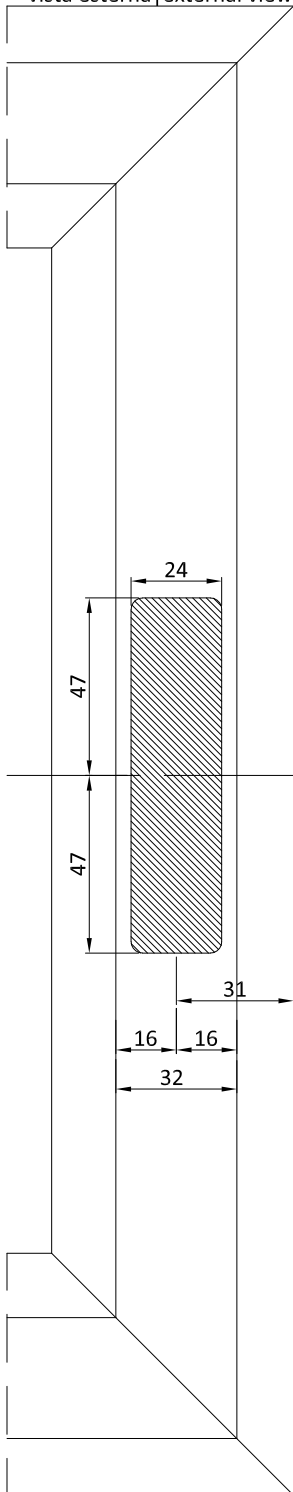

vista interna | internal view

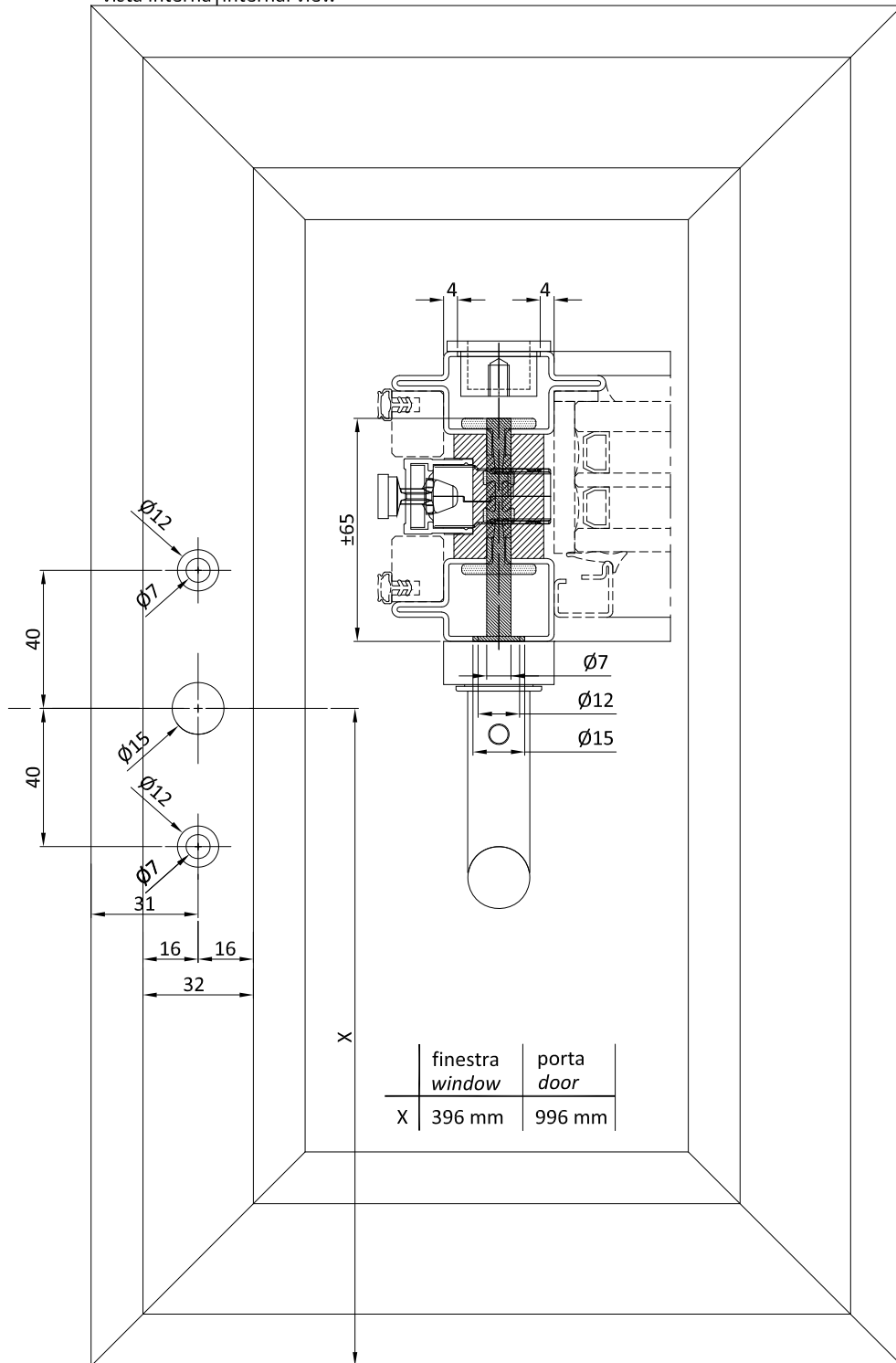

Schema | Type S2, T2

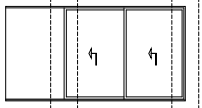

Schema | Type S1, T1

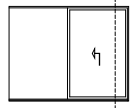

Schema | Type E, F

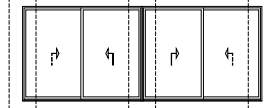

Schema | Type C

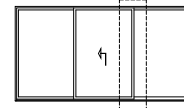

Schema | Type A, B

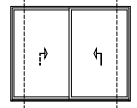

Schema | Type S3, T3

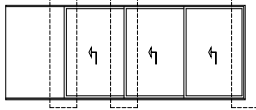

Schema | Type E3, F3

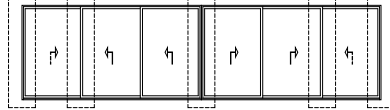

Schema | Type C3

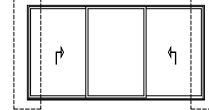

Schema | Type A3, B3

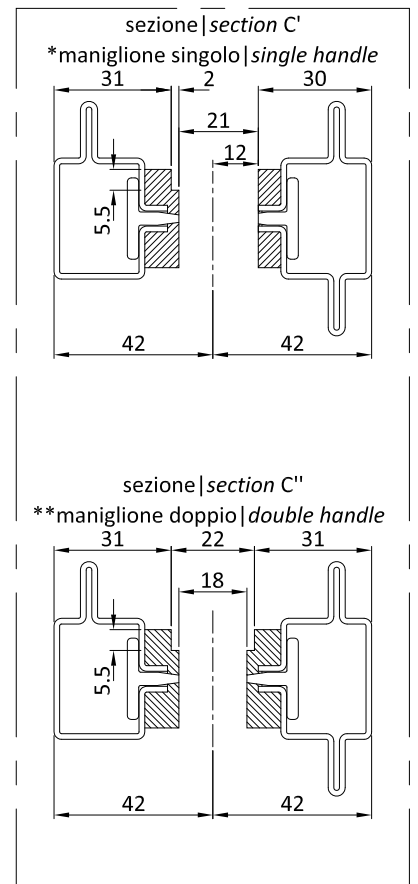
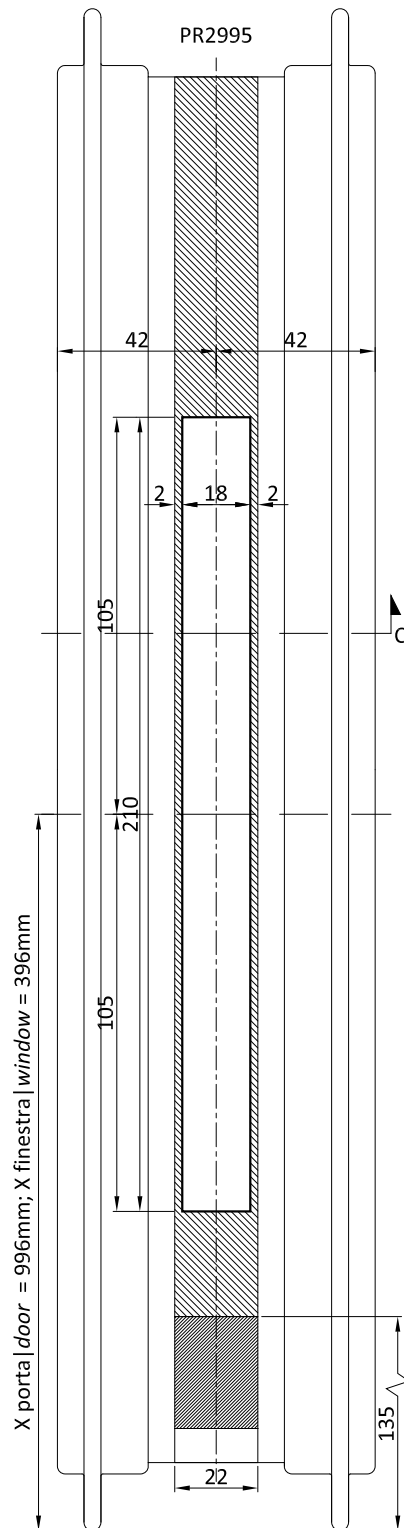
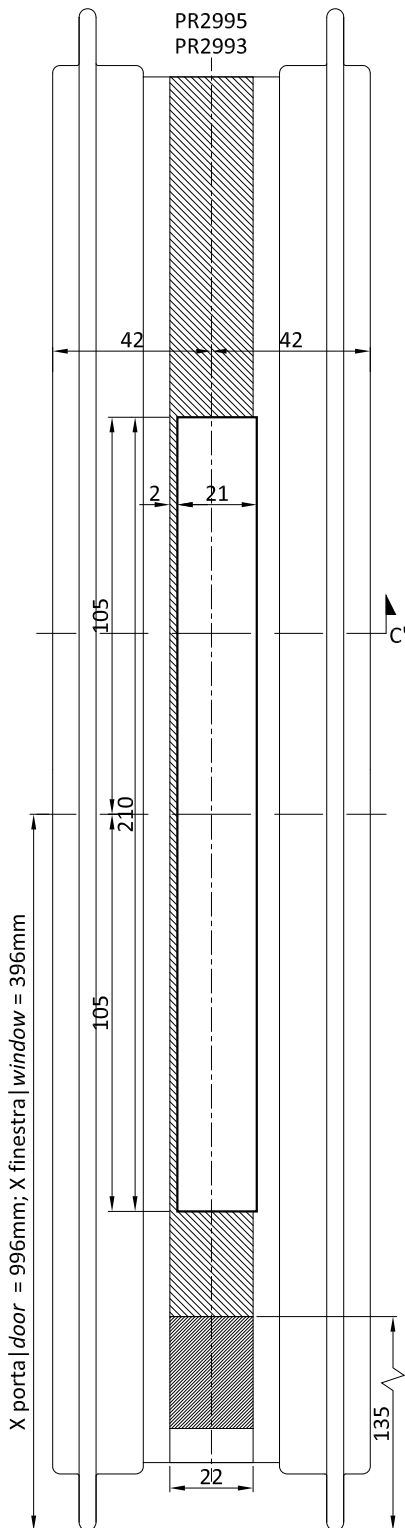
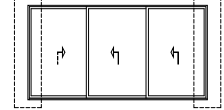

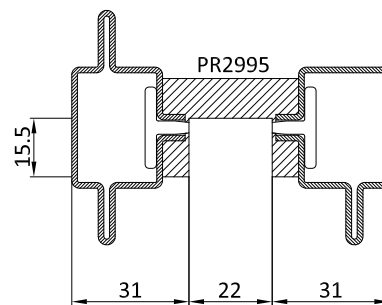
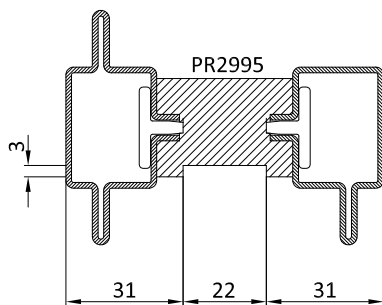
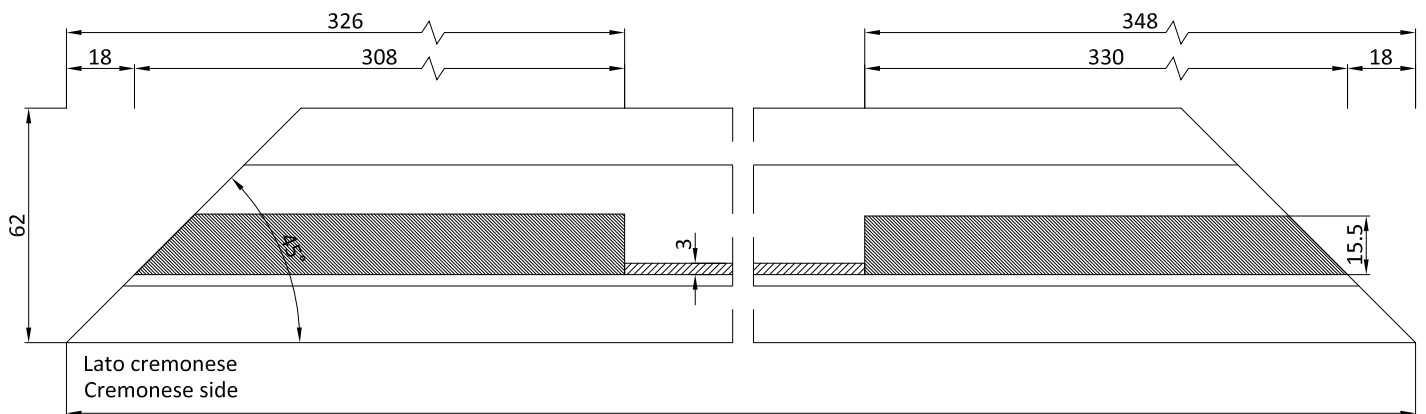
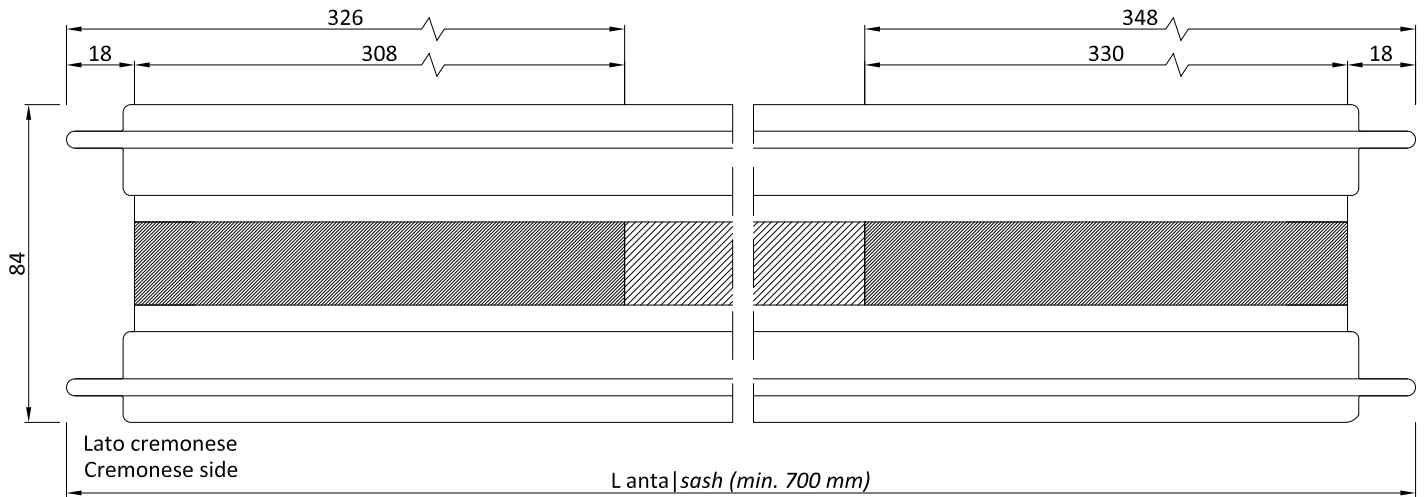
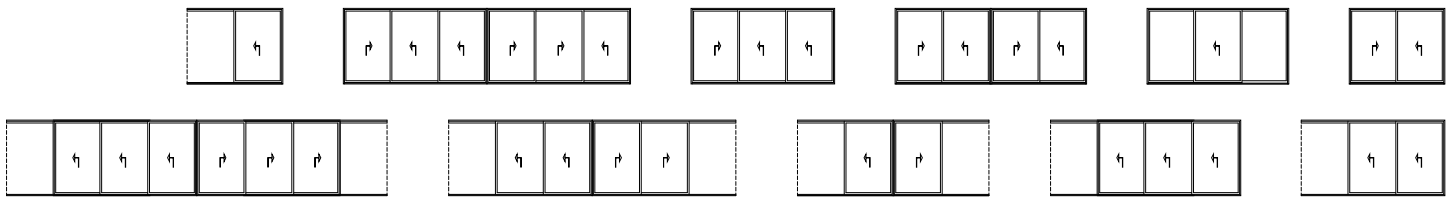

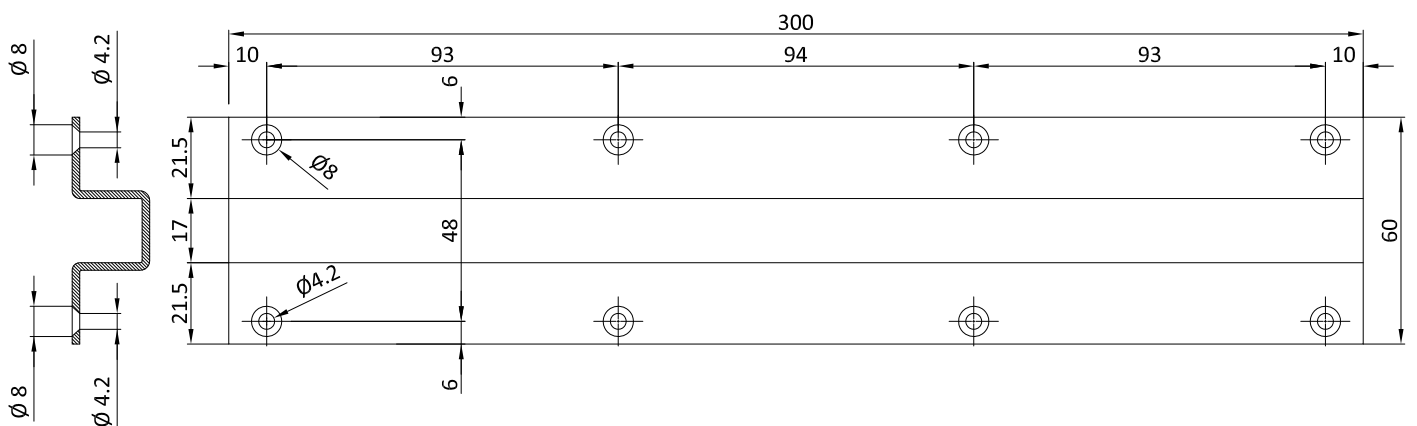
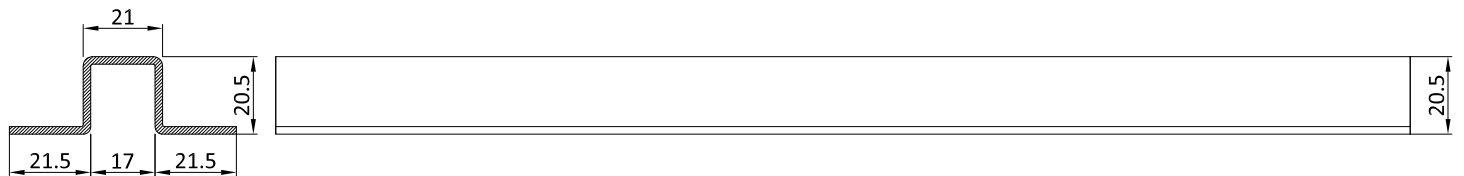
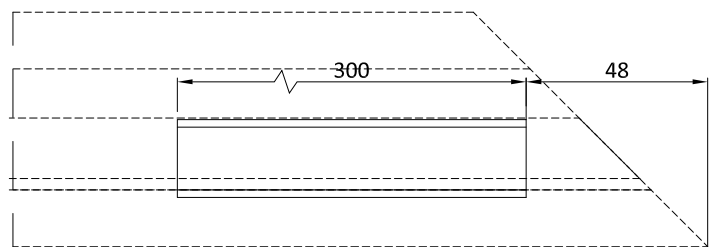
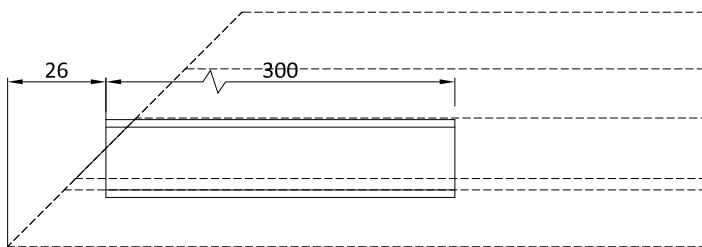
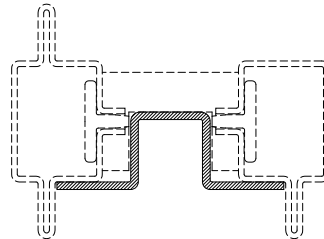
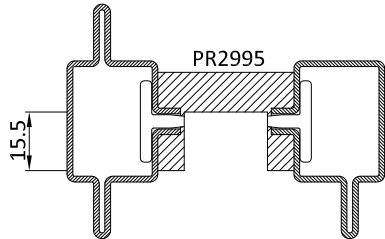
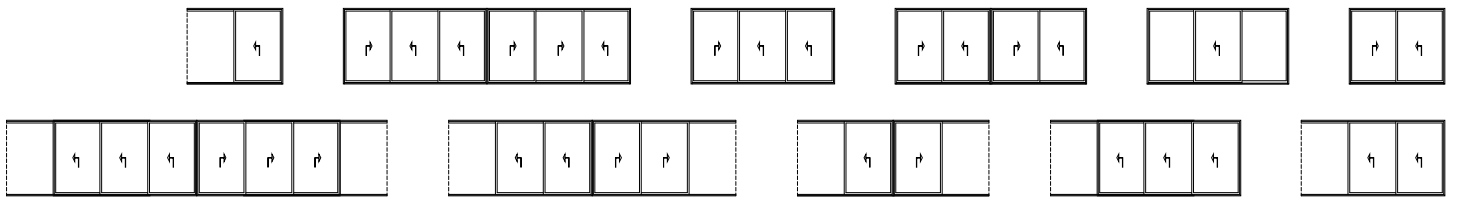

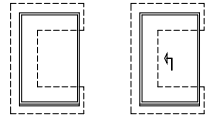

GU2995L GU2996L

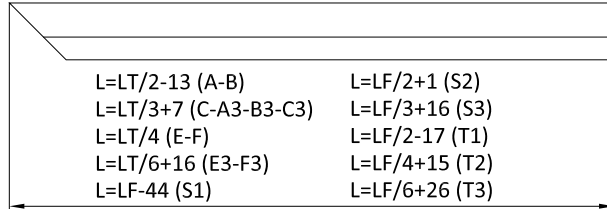
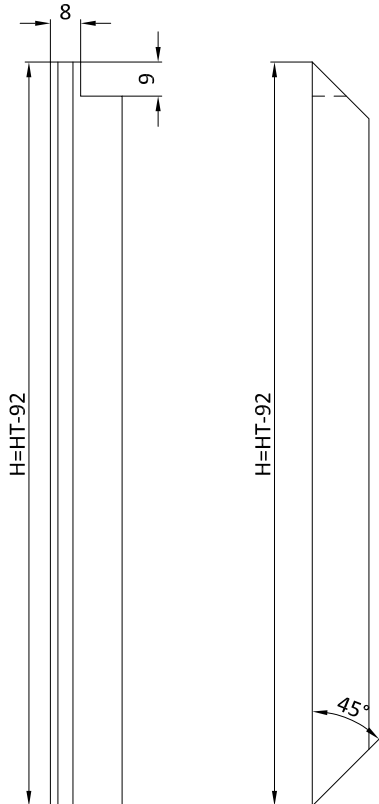

lato cremonese  
cremonese side

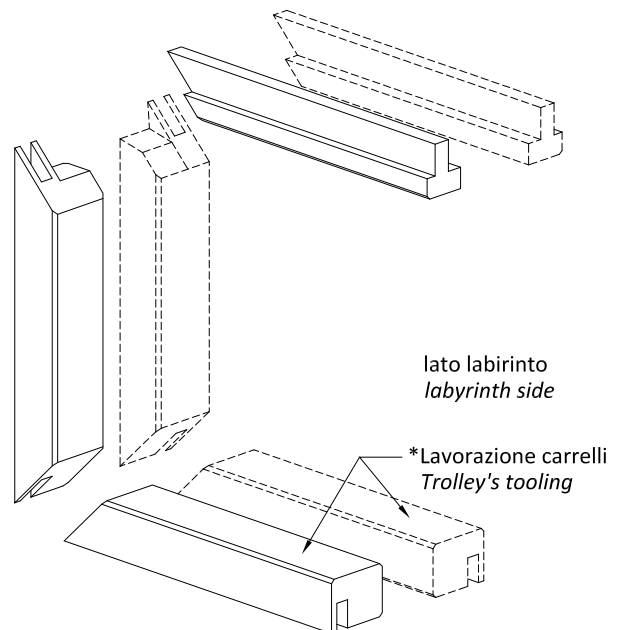

lato labirinto  
labyrinth side

\*Lavorazione carrelli  
Trolley's tooling

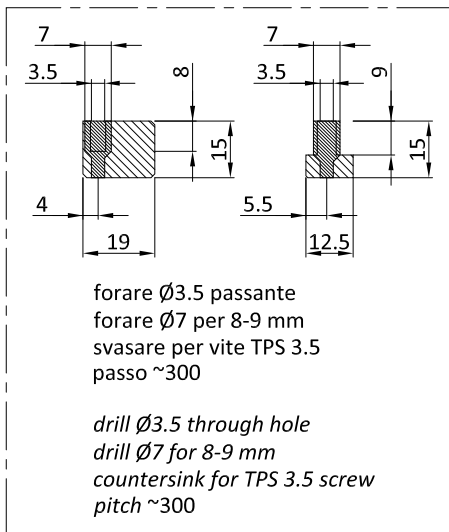
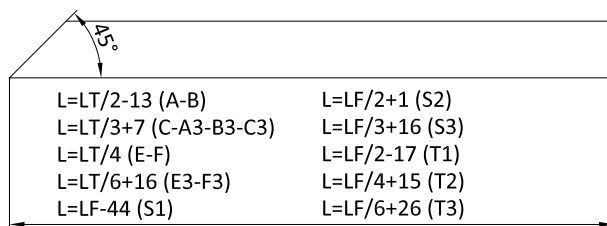

\*Lavorazione carrelli | Trolley's tooling

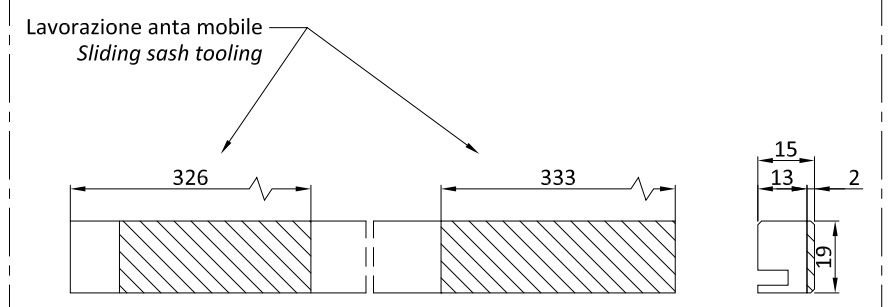



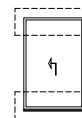

GU2995L GU2996L

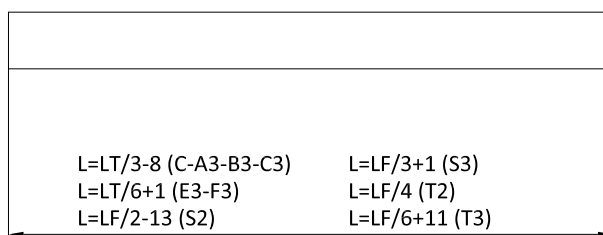
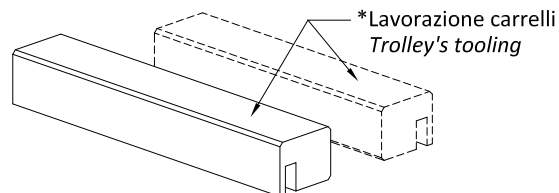
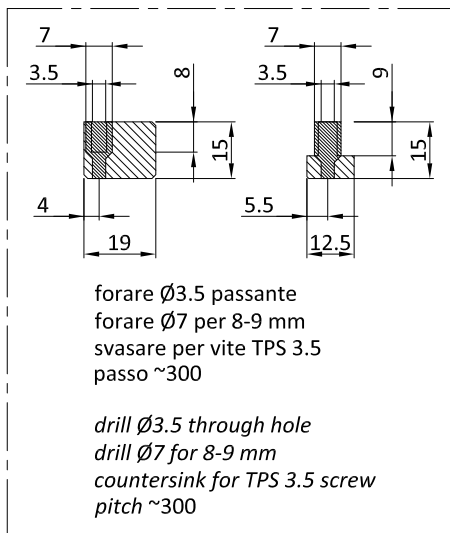
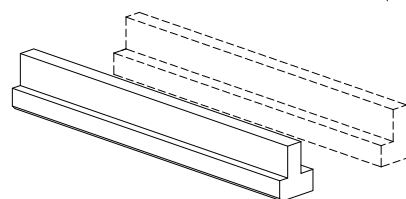
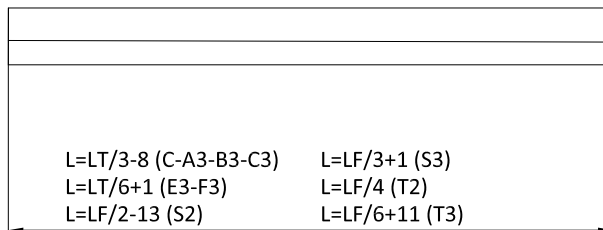

\*Lavorazione carrelli | Trolley's tooling

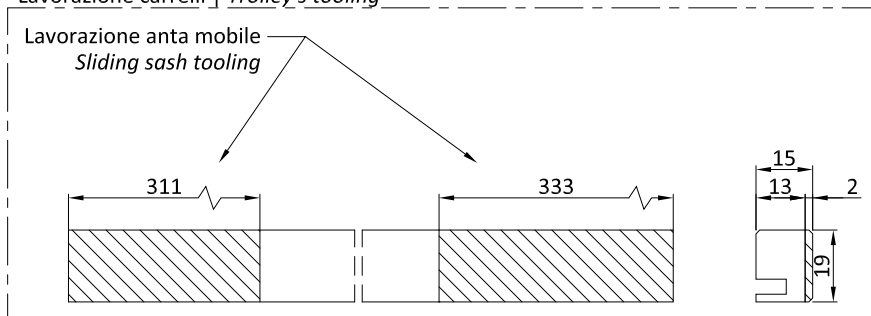

Schema | Type F

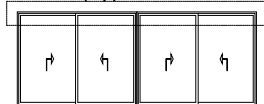

Schema | Type E

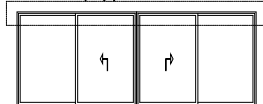

Schema | Type C

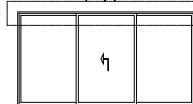

Schema | Type B

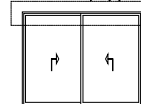

Schema | Type A

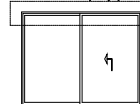

Schema | Type T2

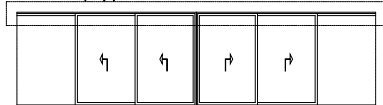

Schema | Type S2

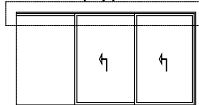

Schema | Type T1

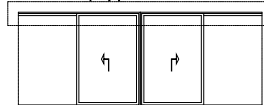

Schema | Type S1

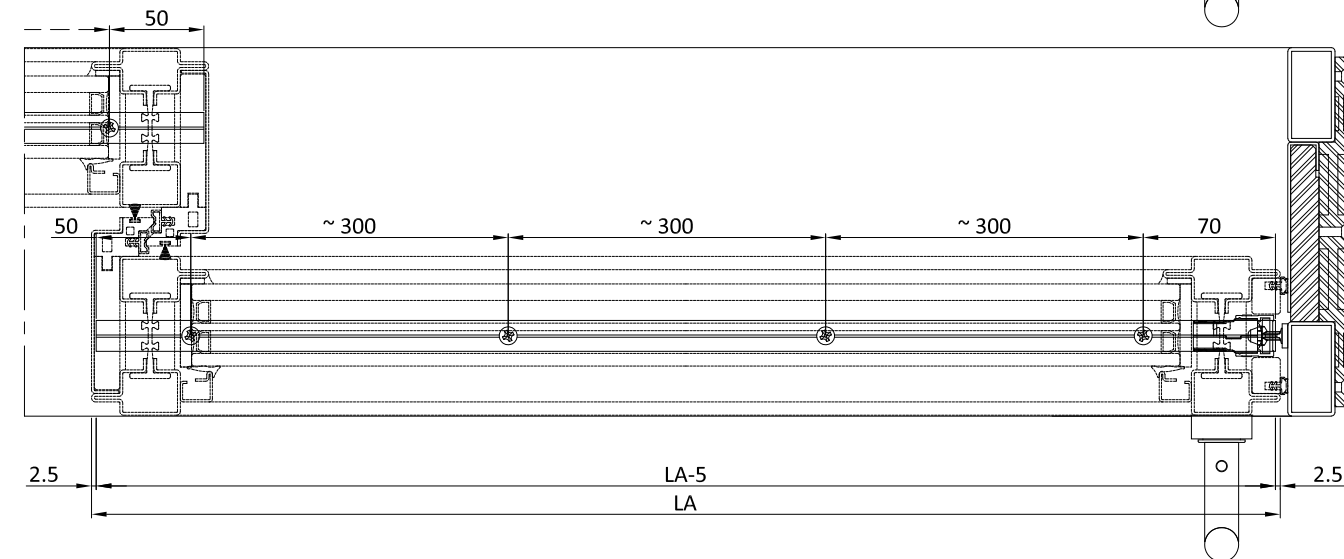
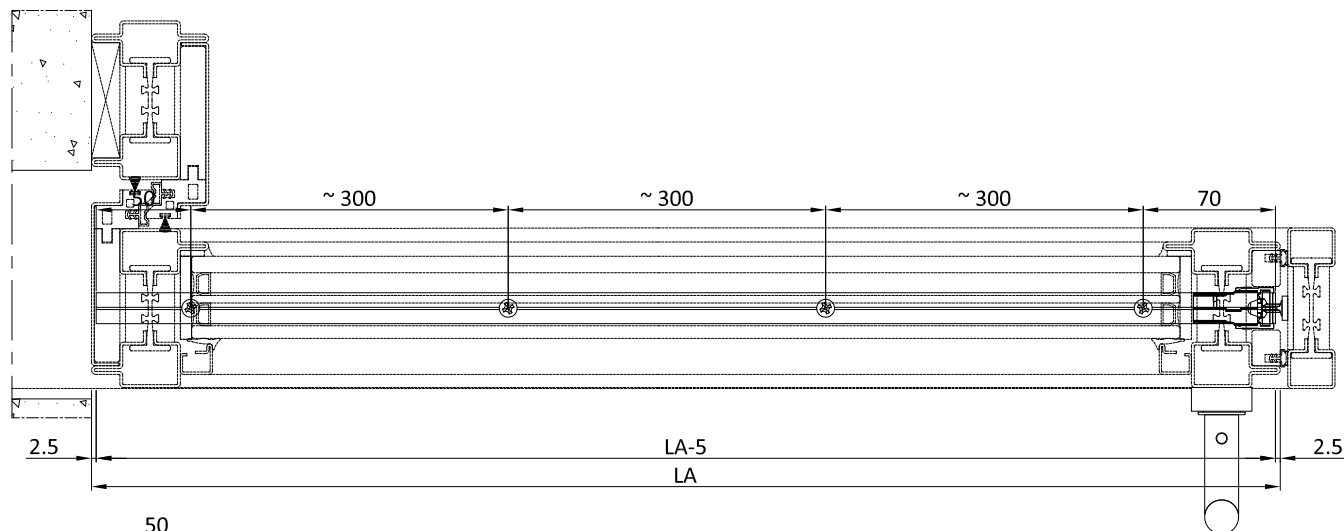
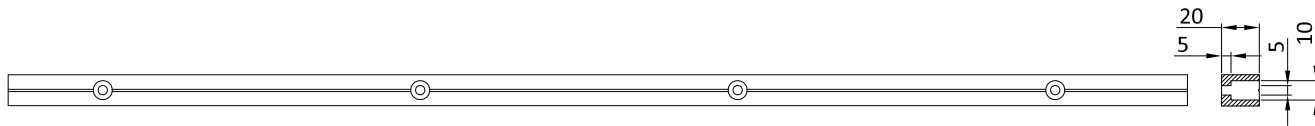
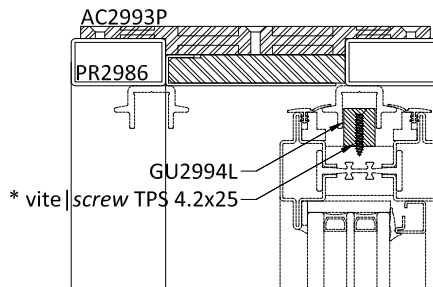
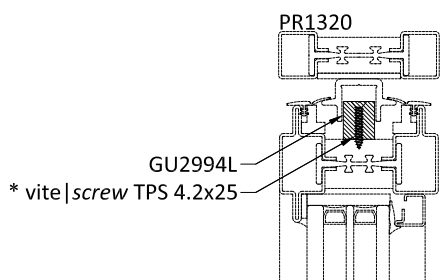
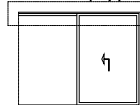

\* viti TPS 4.2x25 non comprese | screws TPS 4.2x25 not supplied

Schema | Type C3

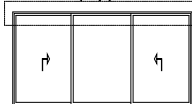

Schema | Type B3

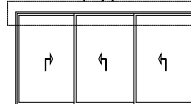

Schema | Type A3

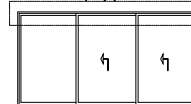

Schema | Type F3

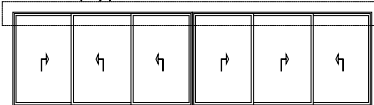

Schema | Type E3

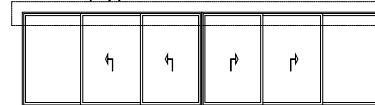

Schema | Type T3

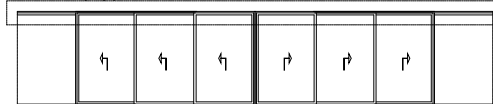

Schema | Type S3

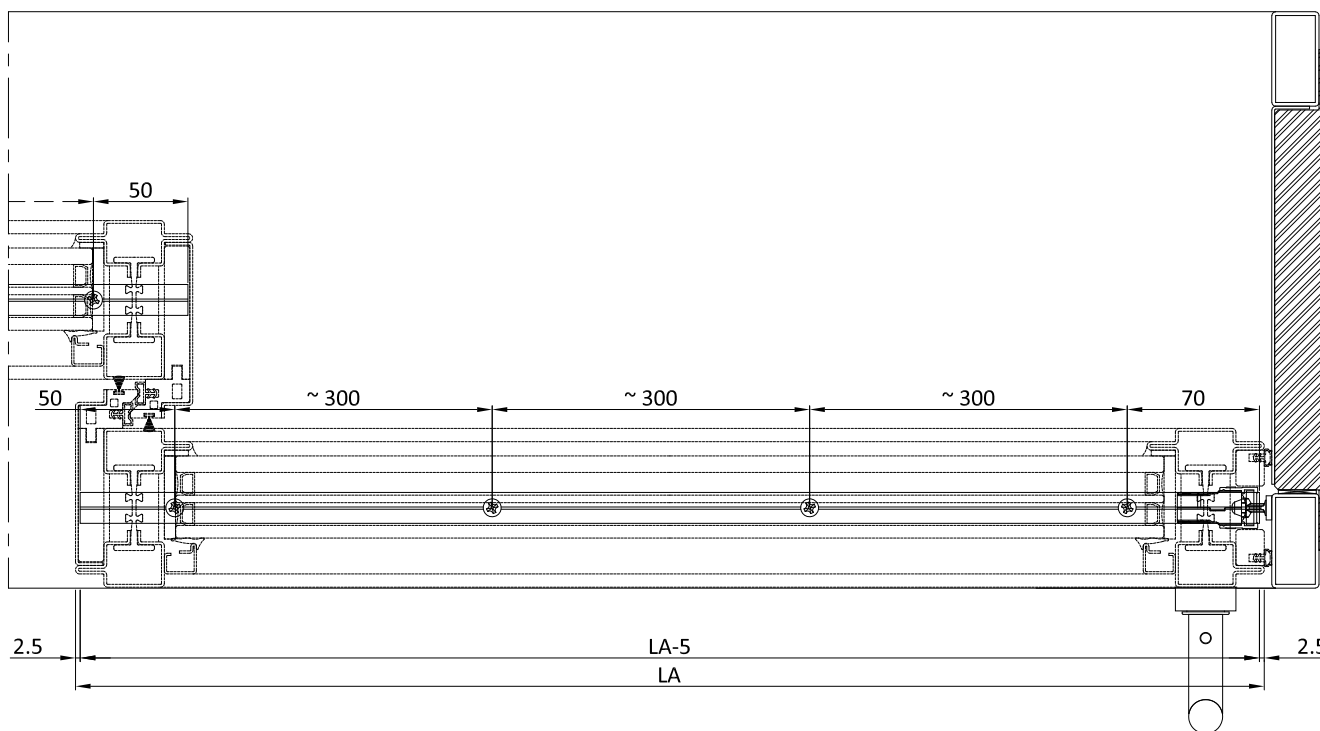
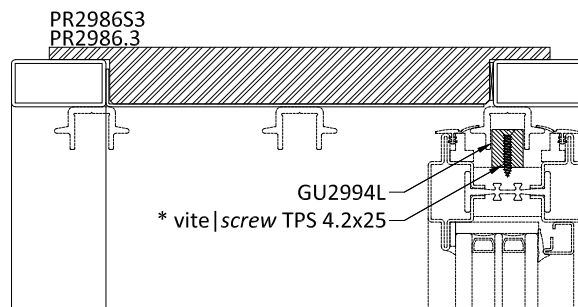
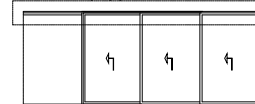

\* viti TPS 4.2x25 non comprese | screws TPS 4.2x25 not supplied

Schema | Type E

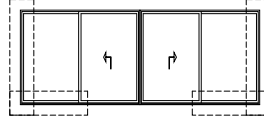

Schema | Type C

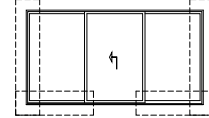

Schema | Type A

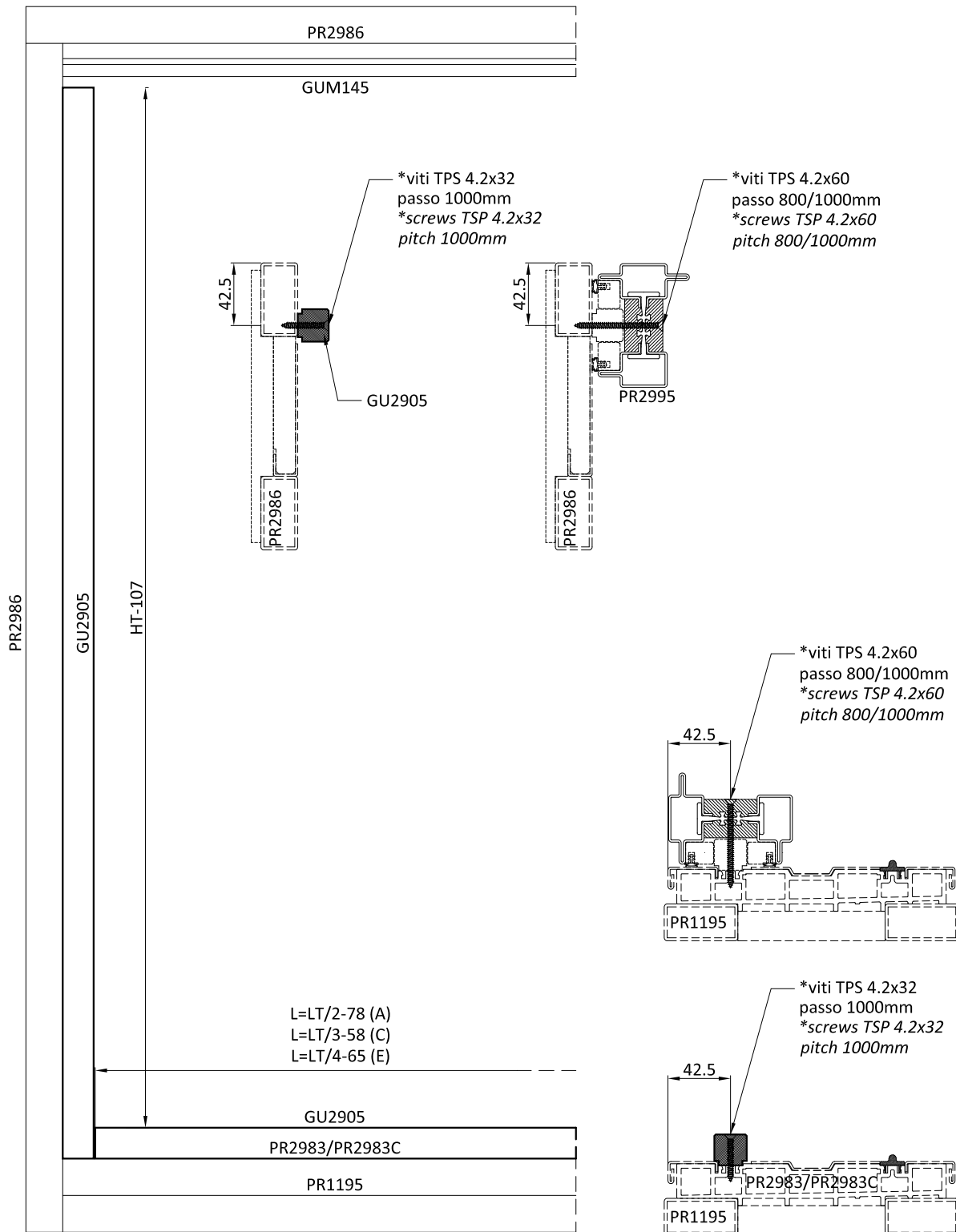
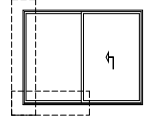

\*viti non comprese  
\*screws not supplied

Schema | Type E3

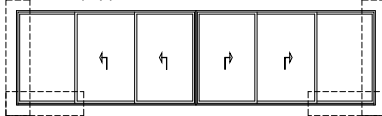

Schema | Type C3

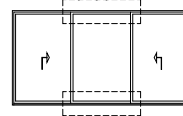

Schema | Type A3

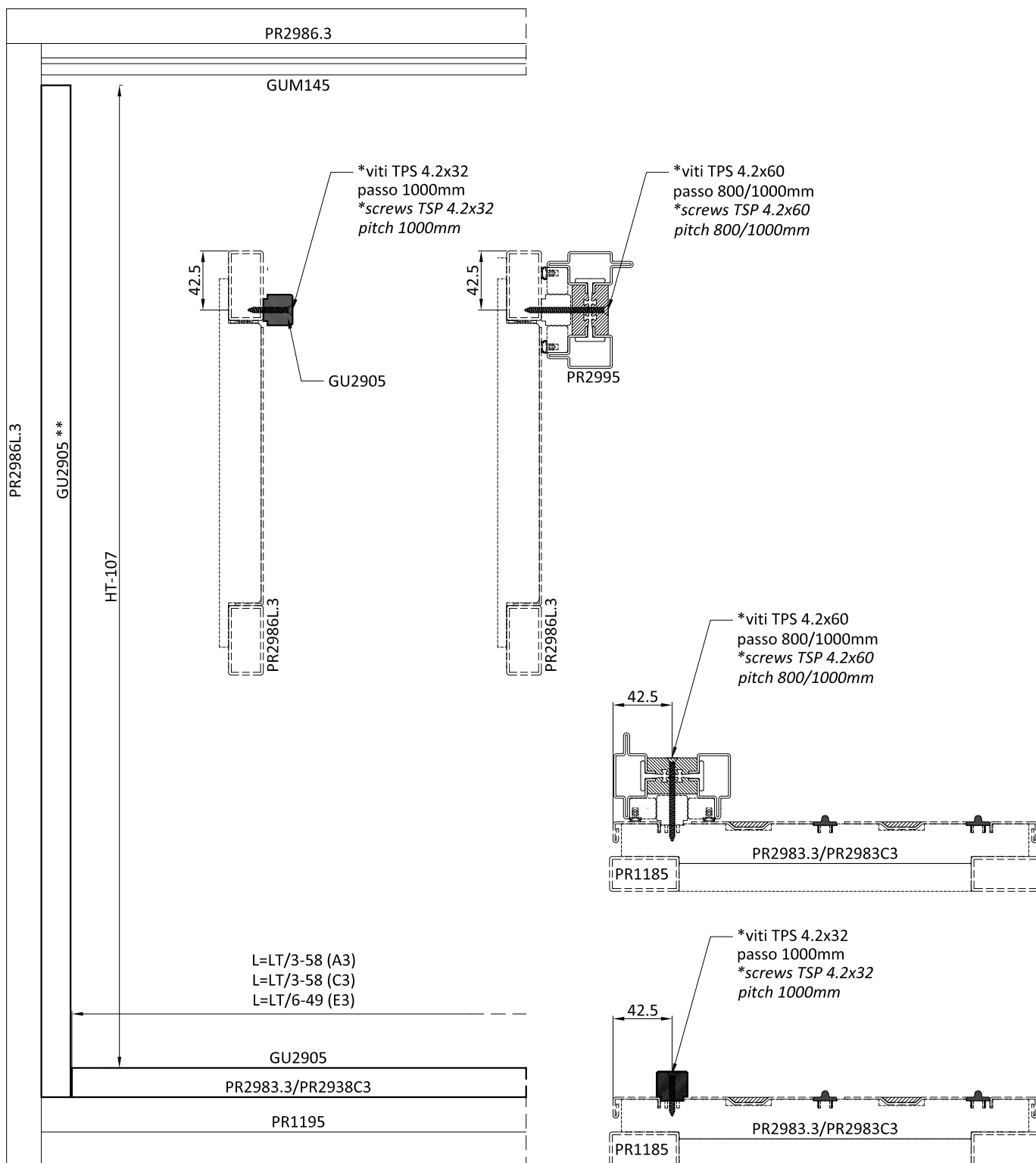
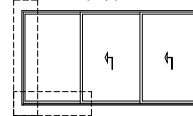

\*viti non comprese  
\*screws not supplied  
\*\*non per schema C3  
\*\*not for type C3

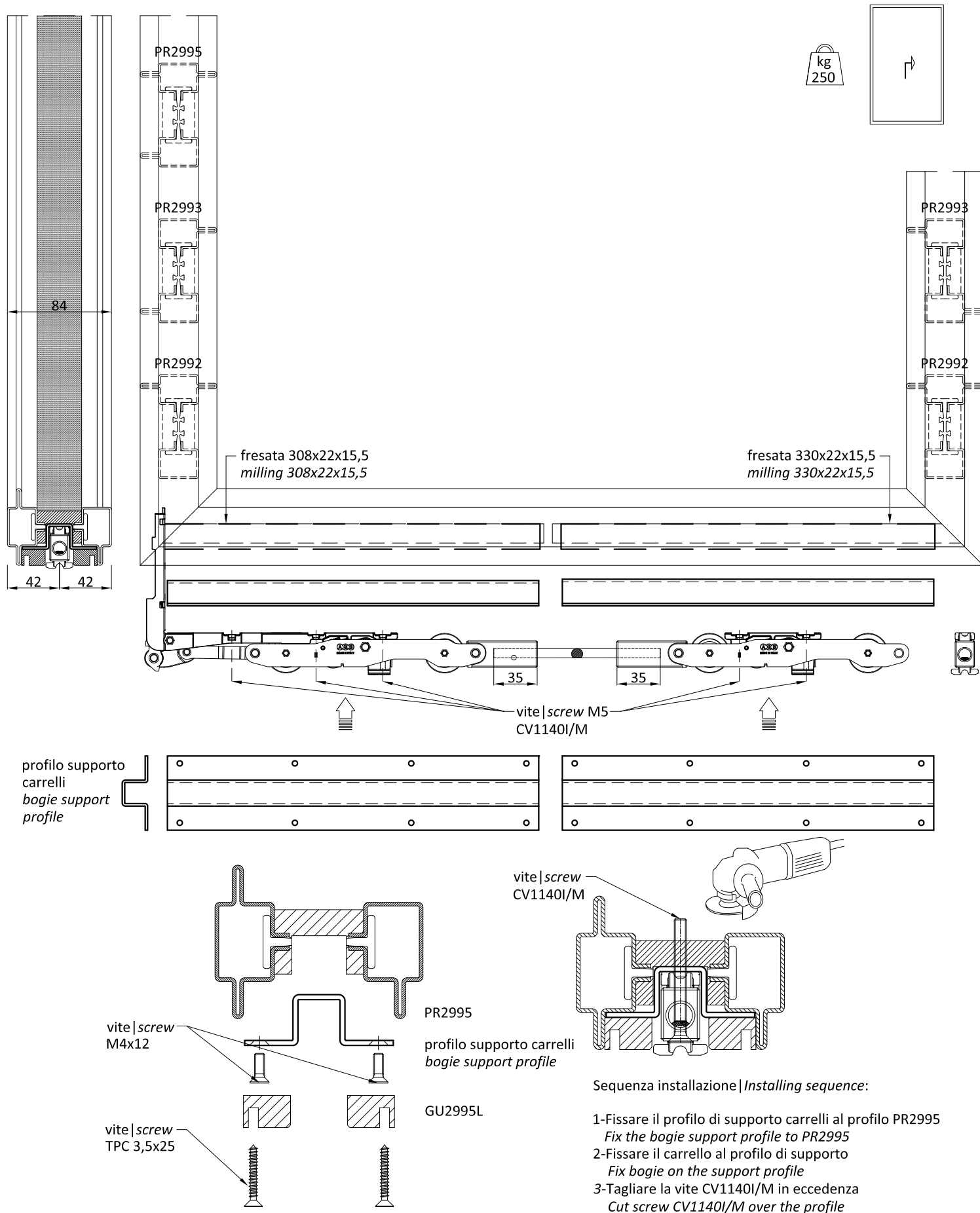

viti M4x12, TPC 4,2x25 non comprese - CV1140I/M fornita con il kit  
M4x12, TPC 4,2x25 screws not supplied - CV1140I/M supplied with kit

- 1) Profilo metallico | *Metallic profile*
- 2) Estruso in PVC rigido | *Extruded PVC profile*
- 3) Estruso in PVC rigido | *Extruded PVC profile*

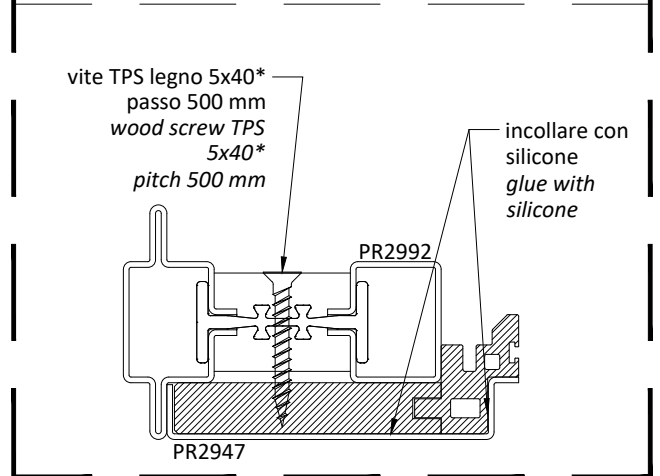
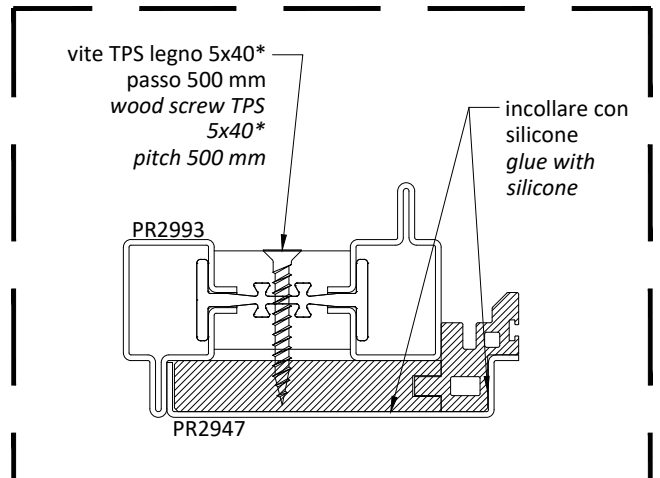
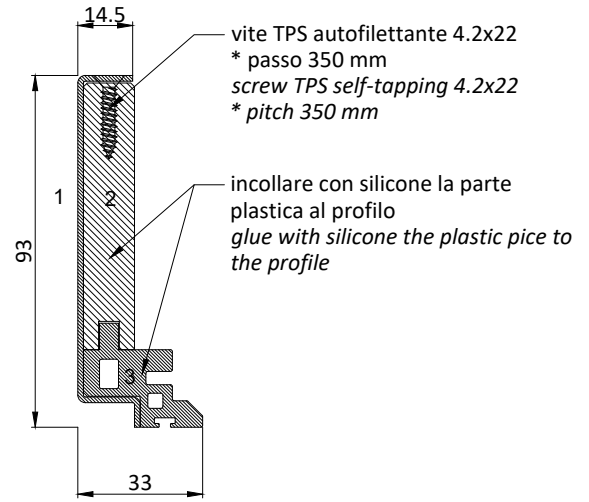
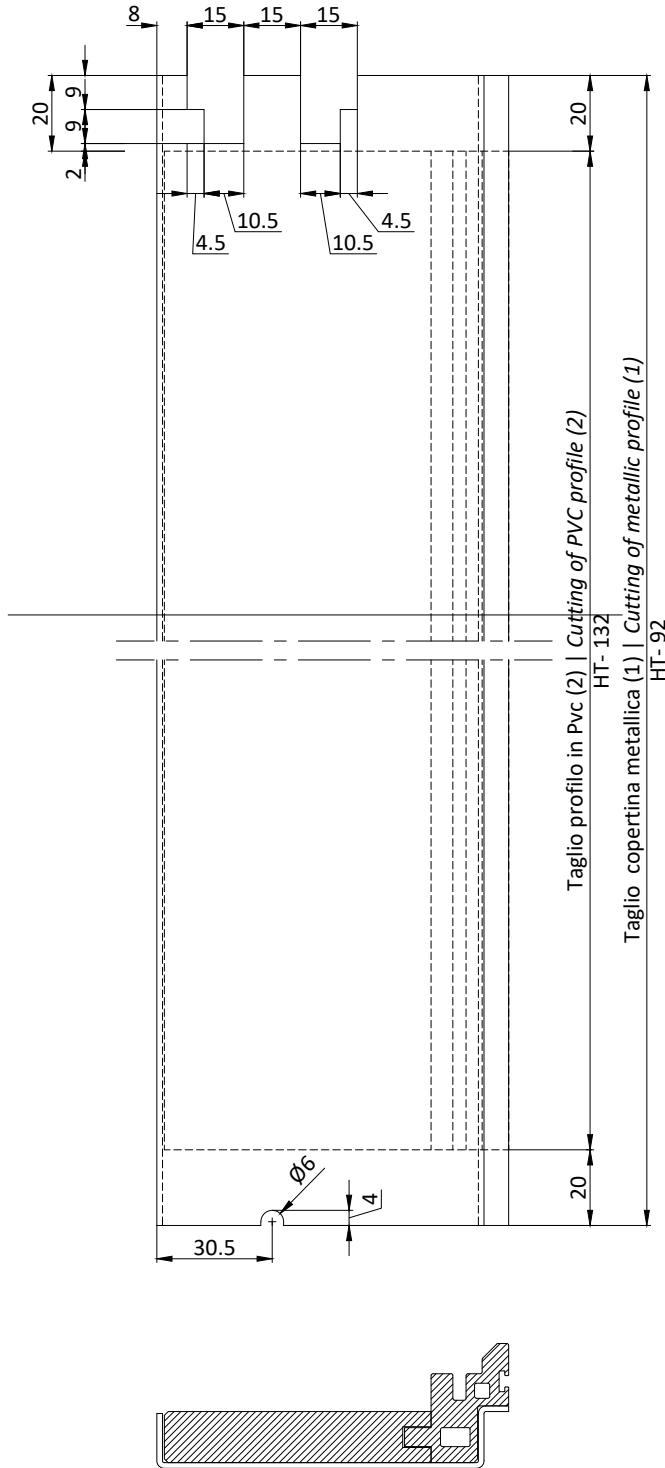
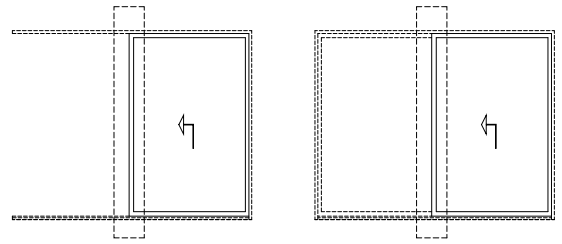

\* viti TPS autofilettante 4.2 x 22 e TPS legno 5x40 non comprese  
\* screws self tapping TPS 4.2 x 22 and wood screws TPS 5X40 not supplied

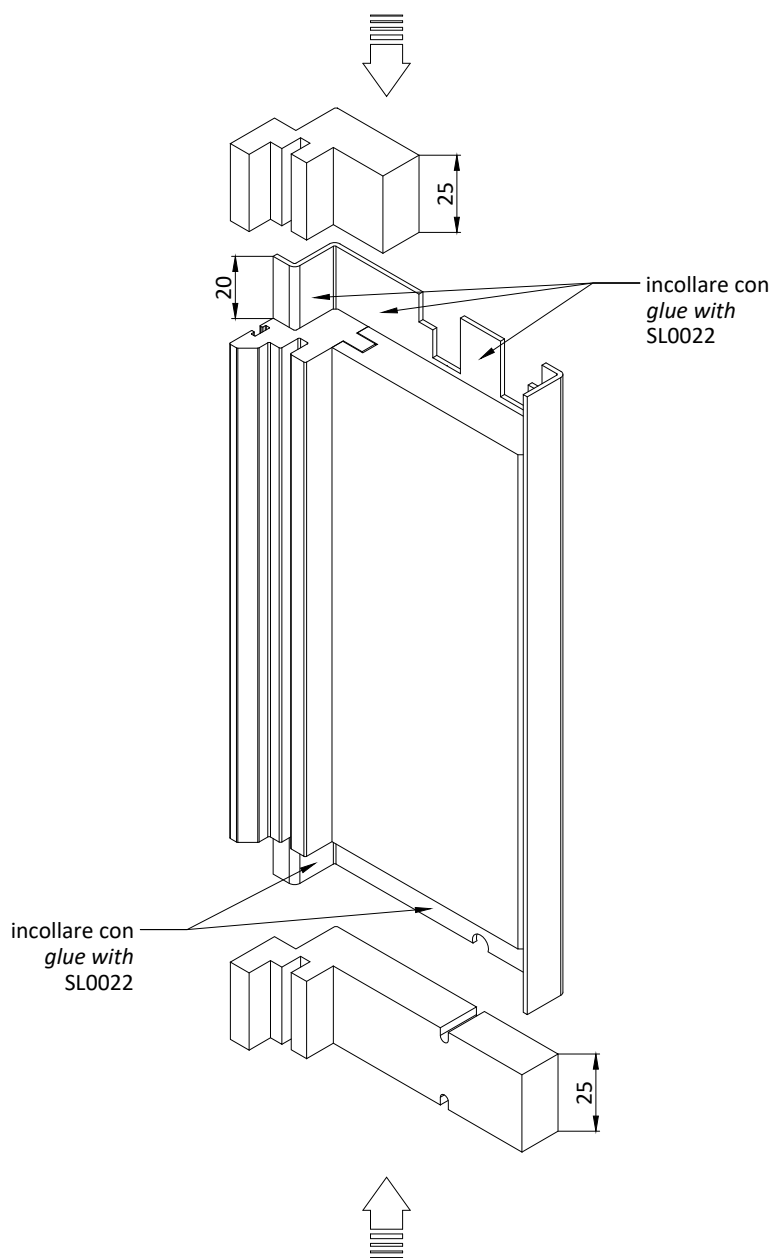
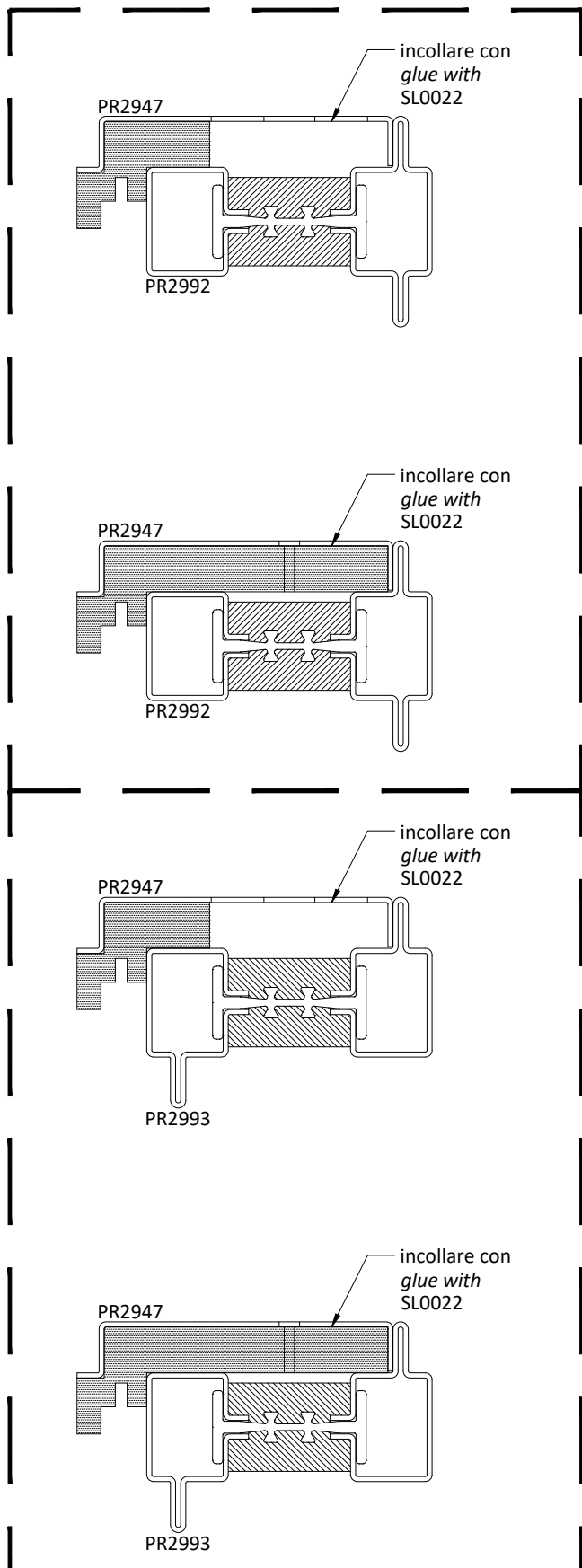
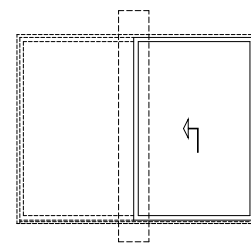



- 1) Profilo metallico | *Metallic profile*
- 2) Estruso in PVC rigido | *Extruded PVC profile*
- 3) Estruso in PVC rigido | *Extruded PVC profile*

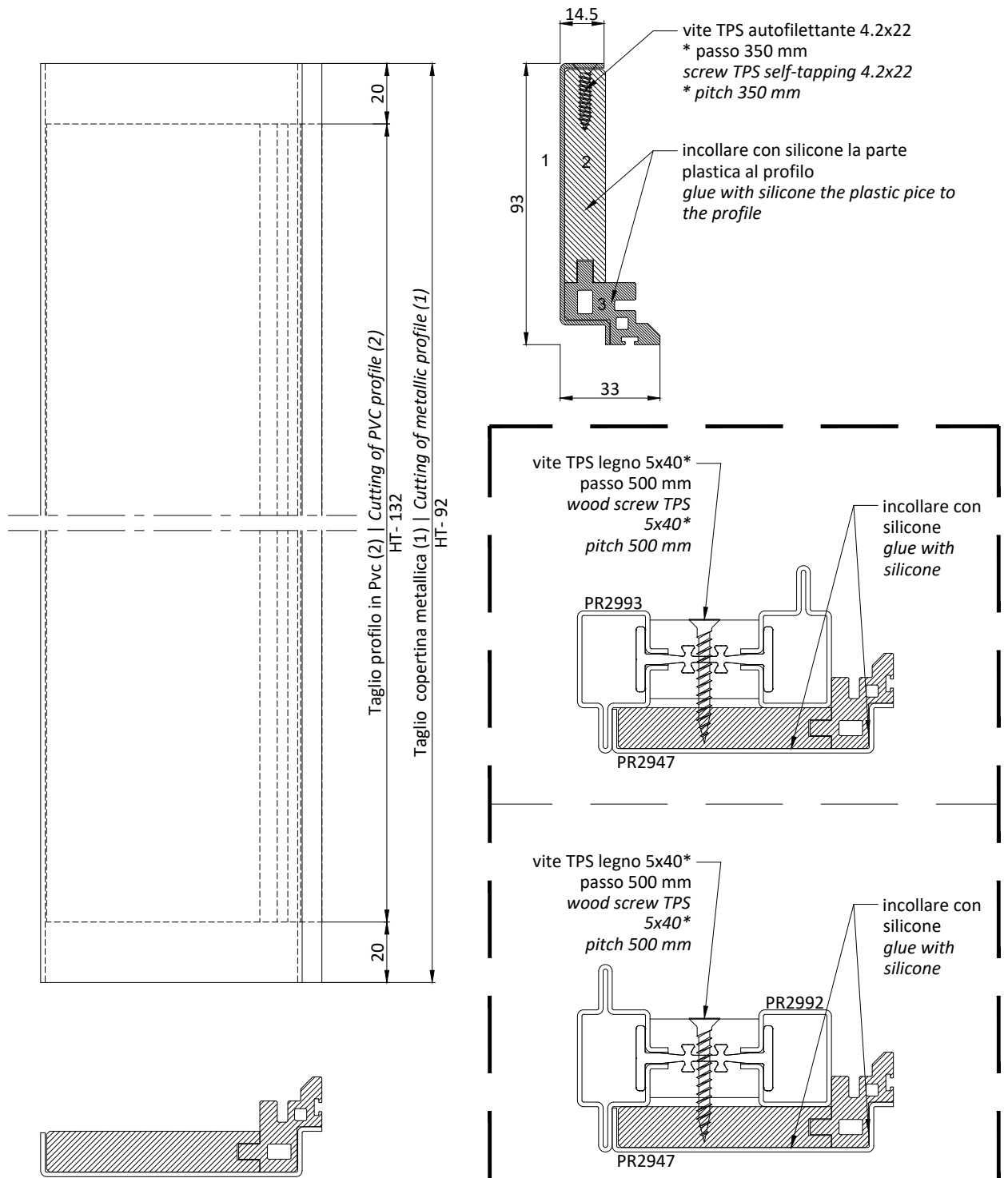

\* viti TPS autofilettante 4.2 x 22 e TPS legno 5x40 non comprese  
\* screws self tapping TPS 4.2 x 22 and wood screws TPS 5X40 not supplied

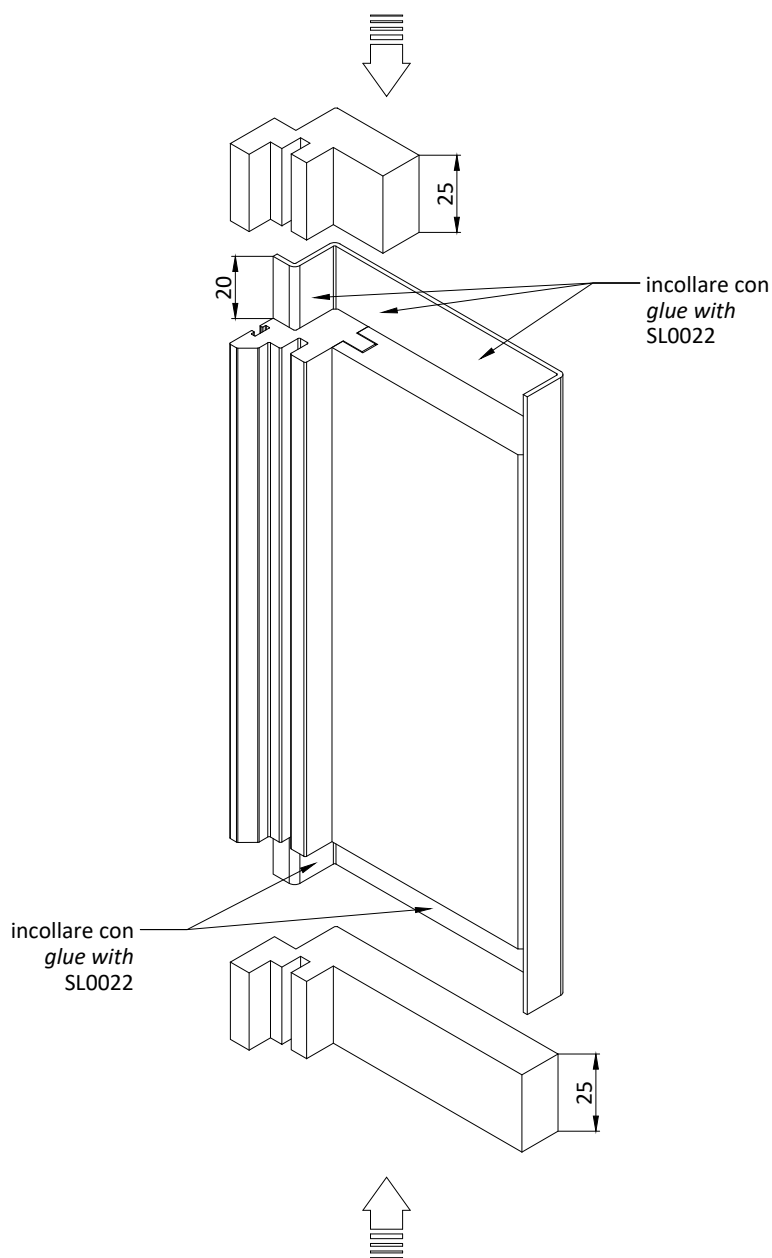
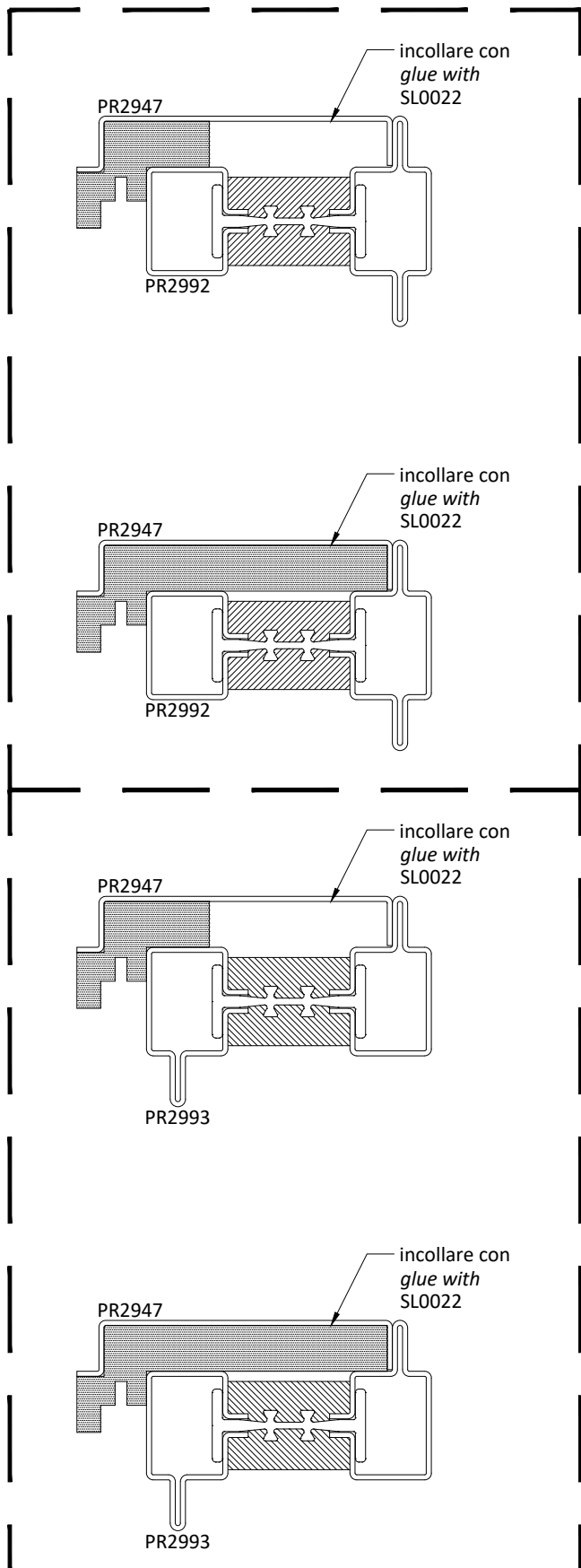
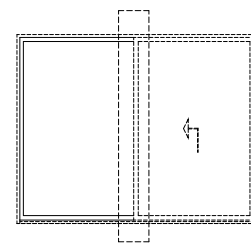

- 1) Profilo metallico | *Metallic profile*
- 2) Estruso in PVC rigido | *Extruded PVC profile*
- 3) Estruso in PVC rigido | *Extruded PVC profile*
- 4) Estruso in PVC rigido | *Extruded PVC profile*

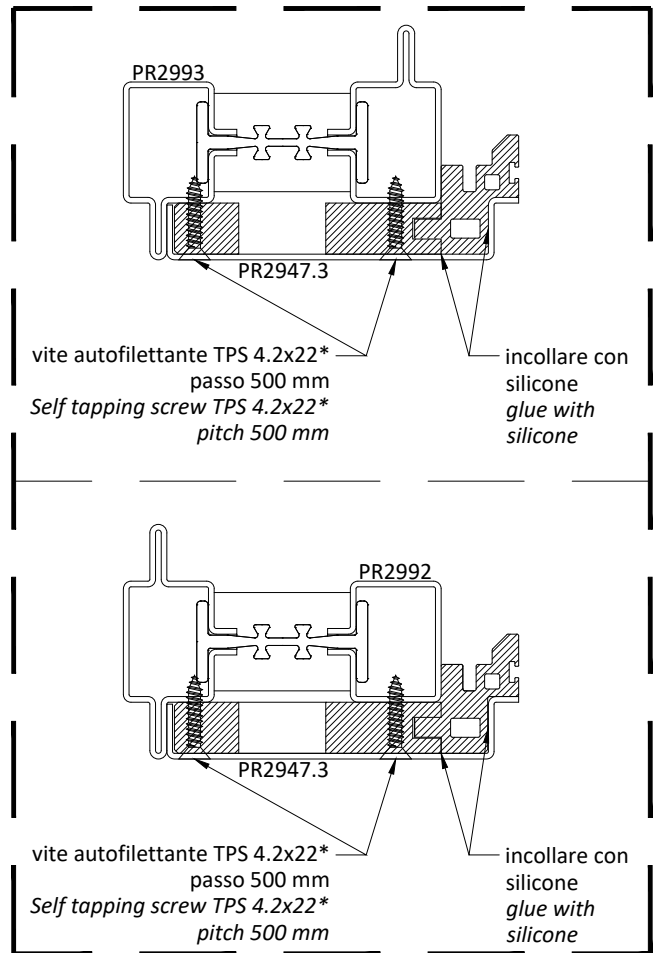
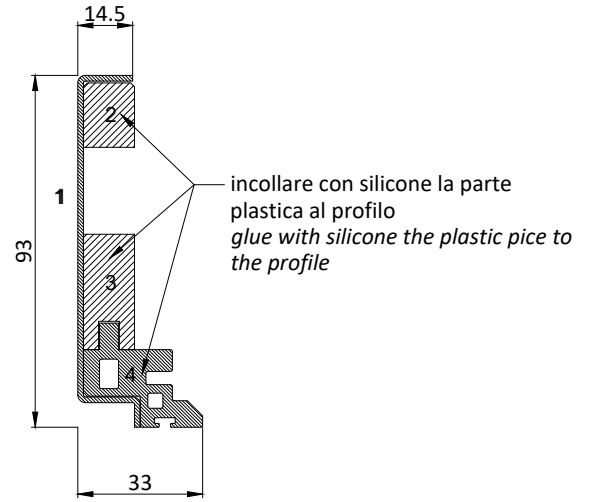
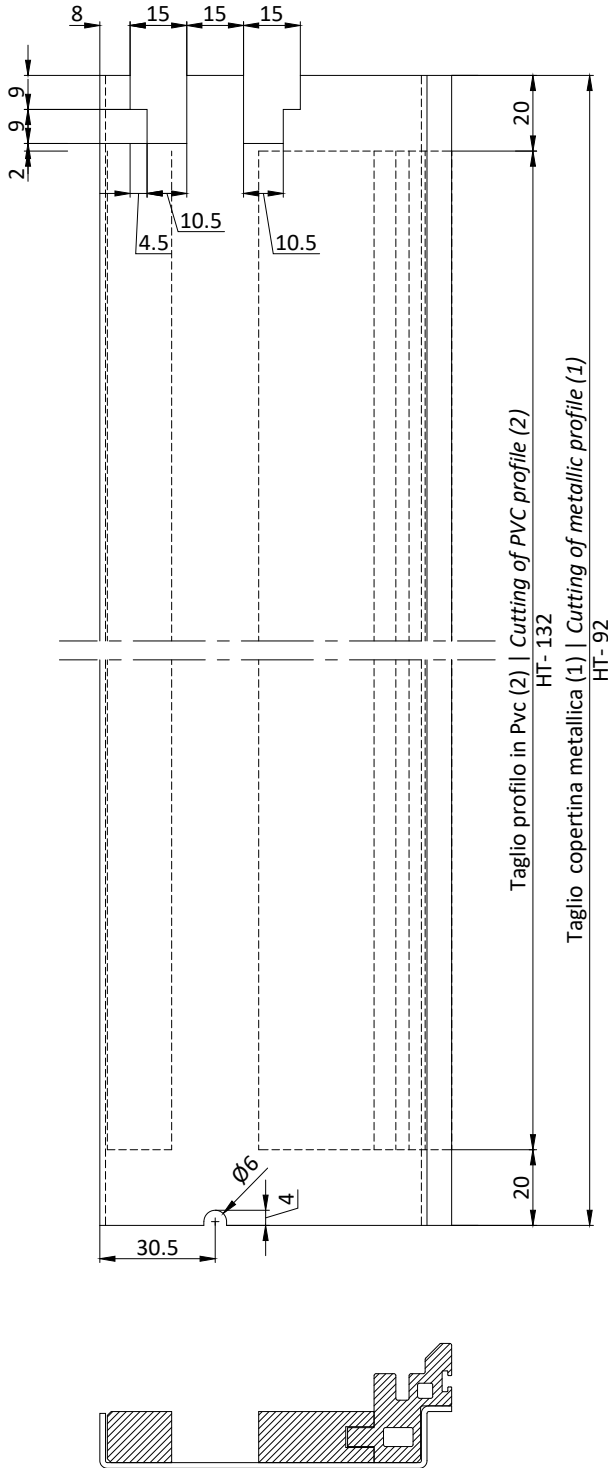
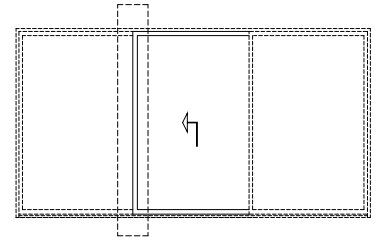

\* viti TPS autofilettante 4.2 x 22 non comprese  
\* screws self tapping TPS 4.2 x 22 not supplied

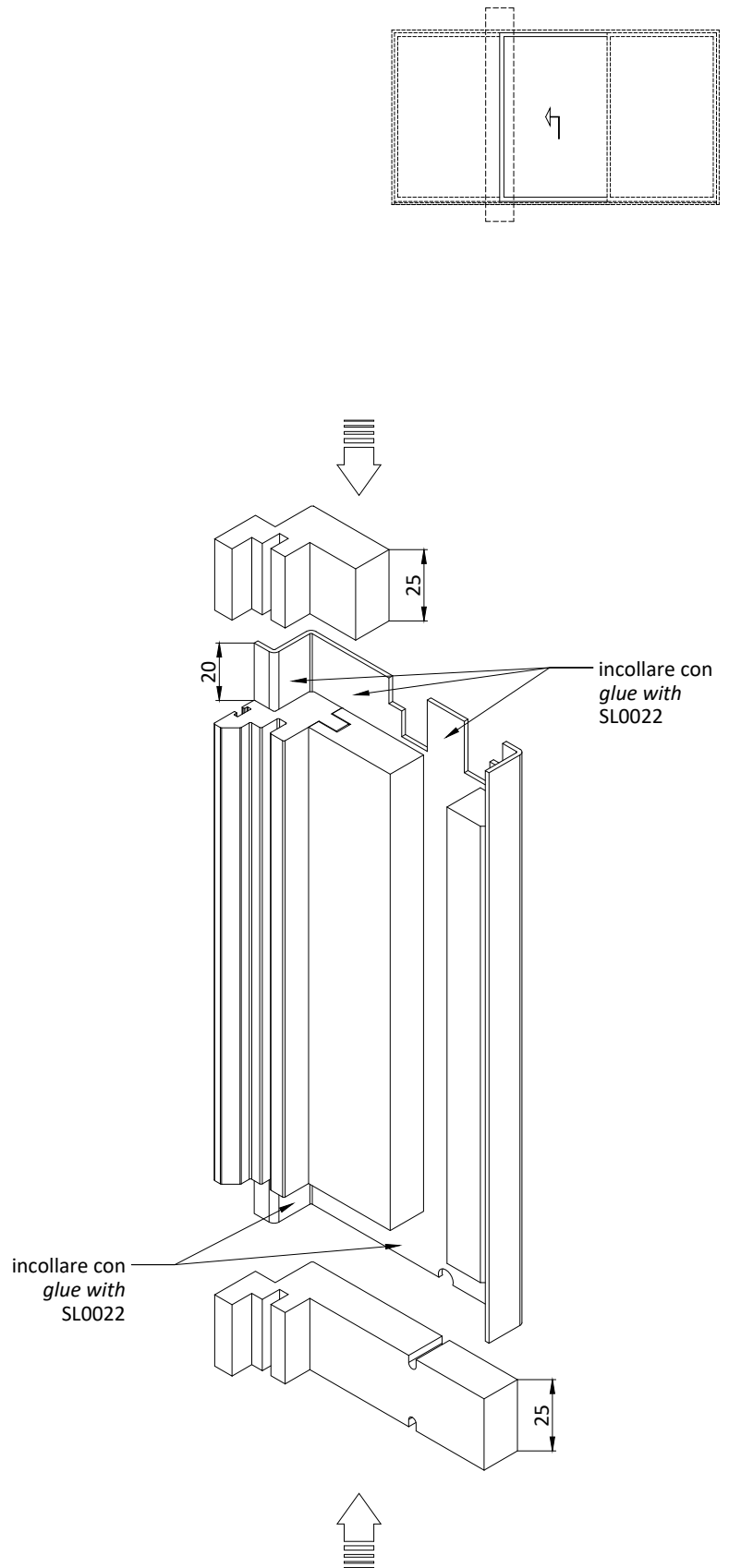
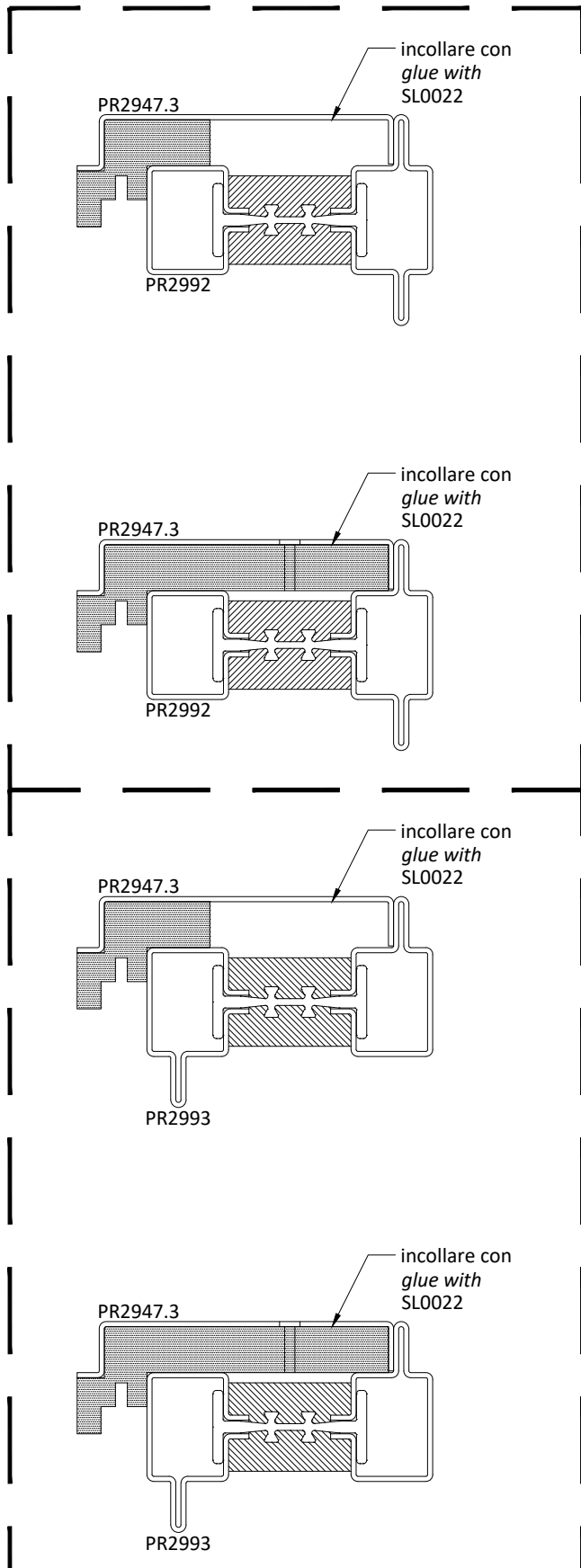

- 1) Profilo metallico | *Metallic profile*
- 2) Estruso in PVC rigido | *Extruded PVC profile*
- 3) Estruso in PVC rigido | *Extruded PVC profile*

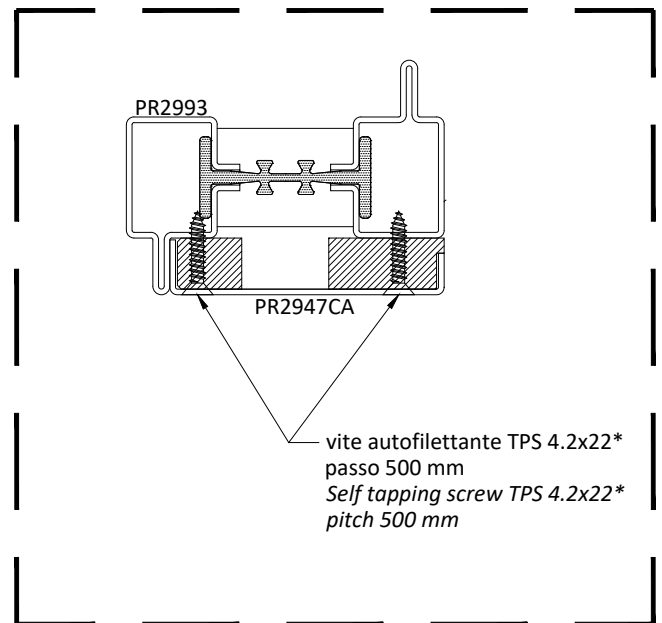
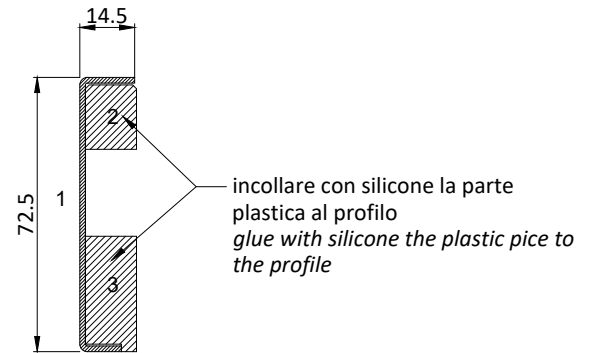
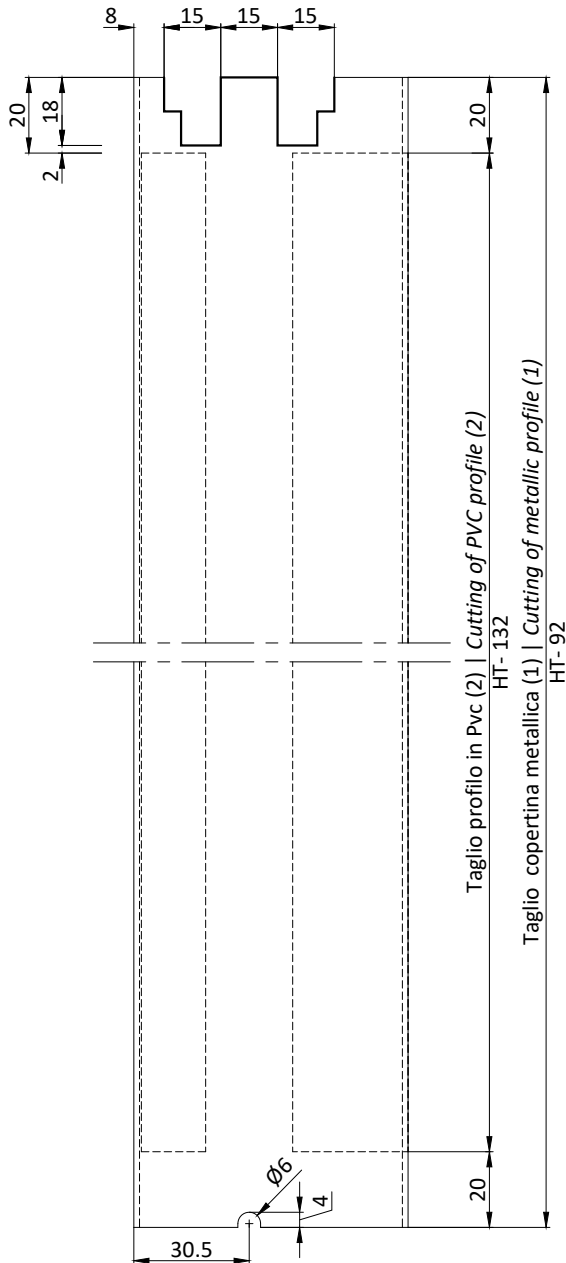
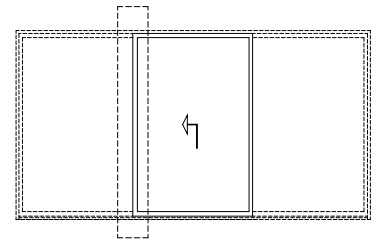

\* viti TPS autofilettante 4.2 x 22 non comprese  
\* screws self tapping TPS 4.2 x 22 not supplied

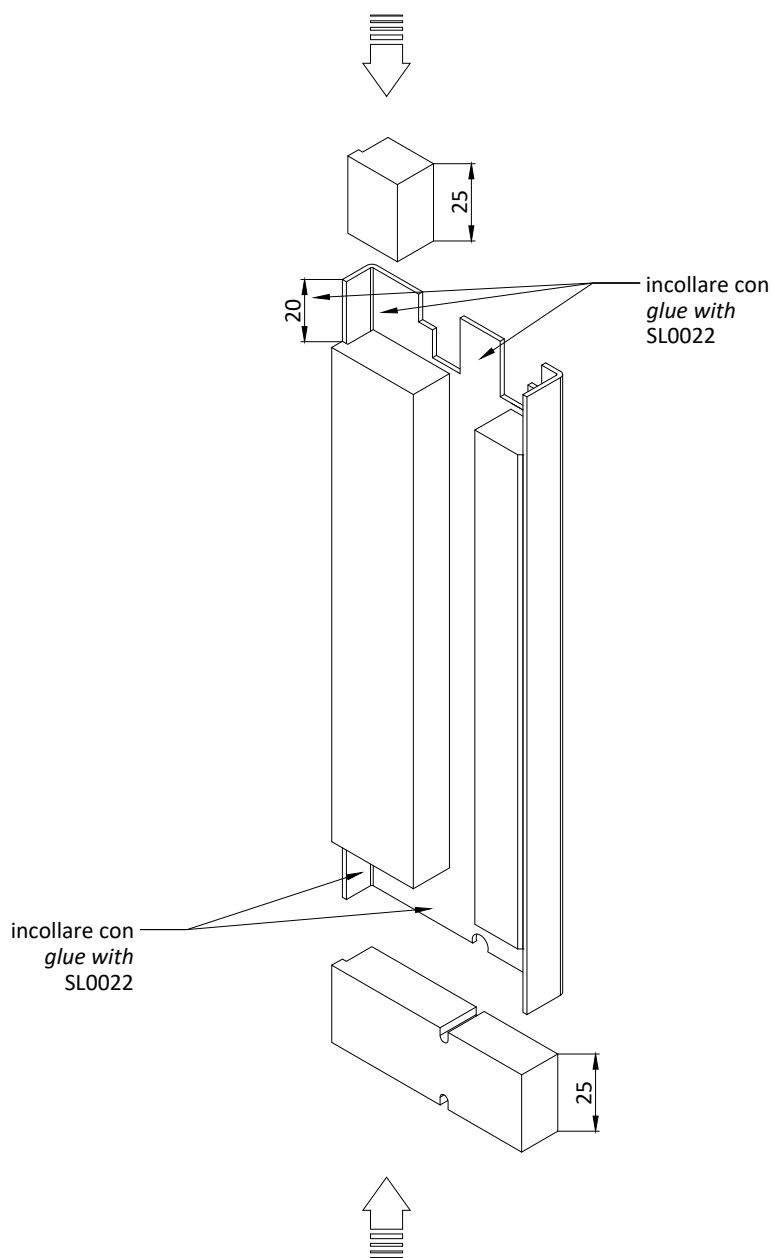
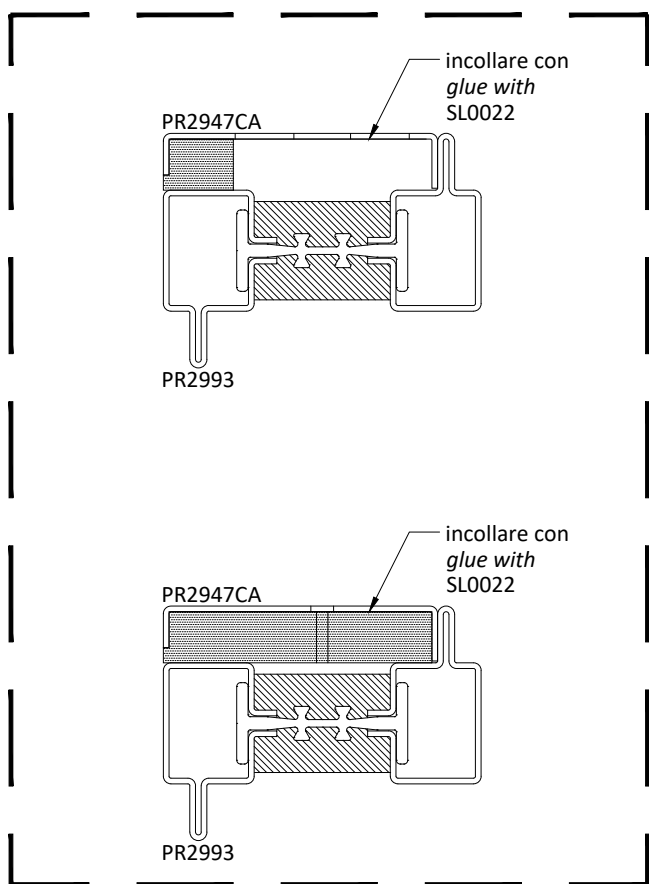
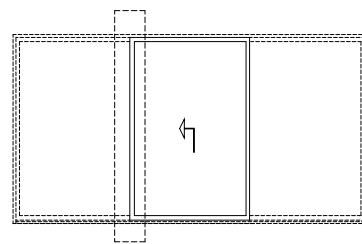

- 1) Profilo metallico | *Metallic profile*
- 2) Estruso in PVC rigido | *Extruded PVC profile*

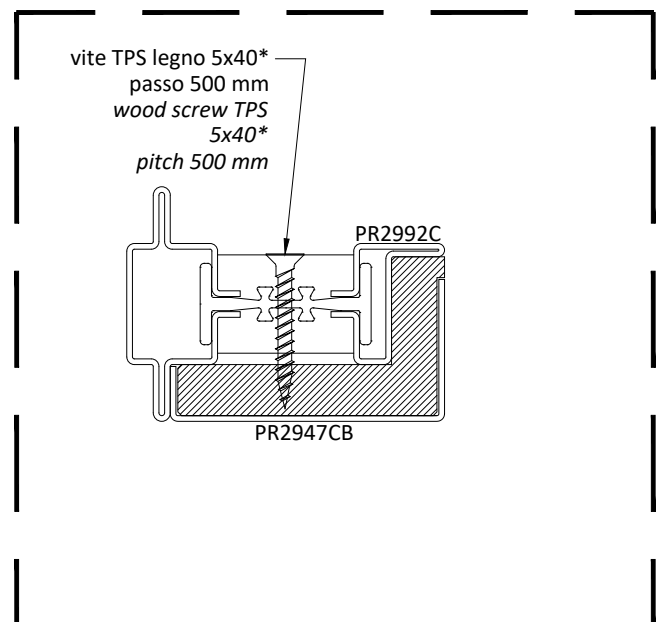
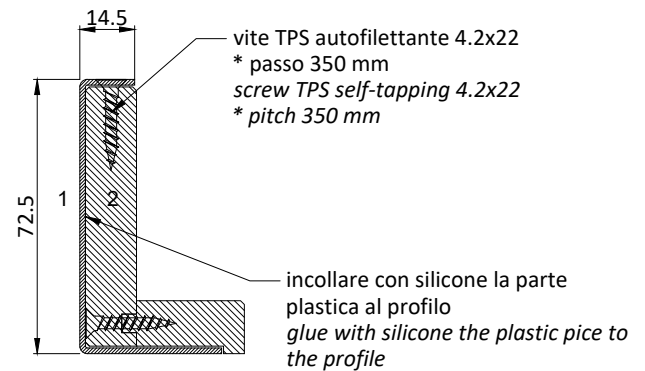
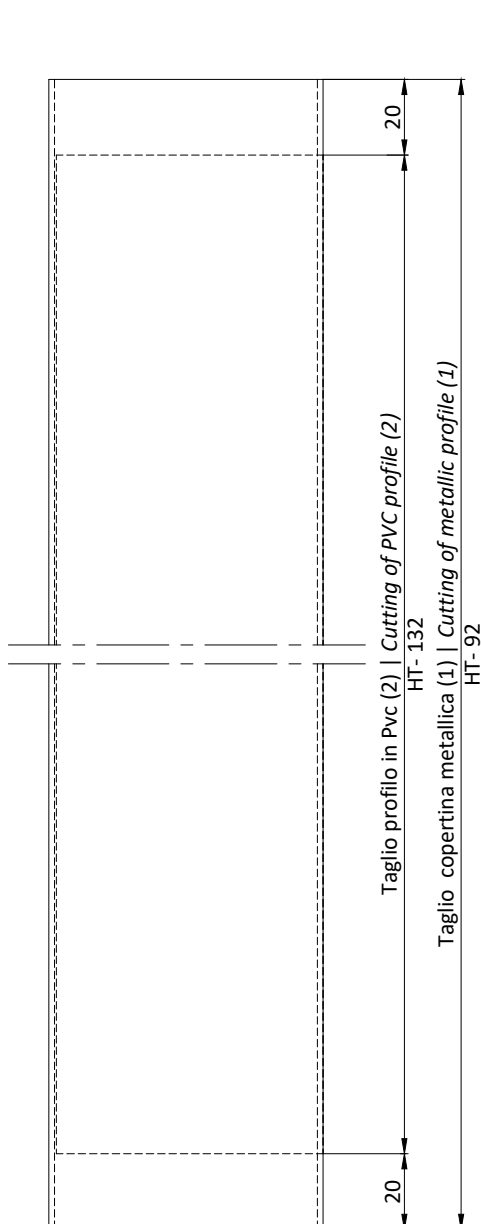
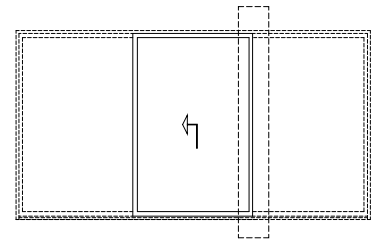

\* viti TPS autofilettante 4.2x22 e TPS legno 5x40 non comprese  
\* *screws self tapping TPS 4.2x22 and wood screws TPS 5x40 not supplied*

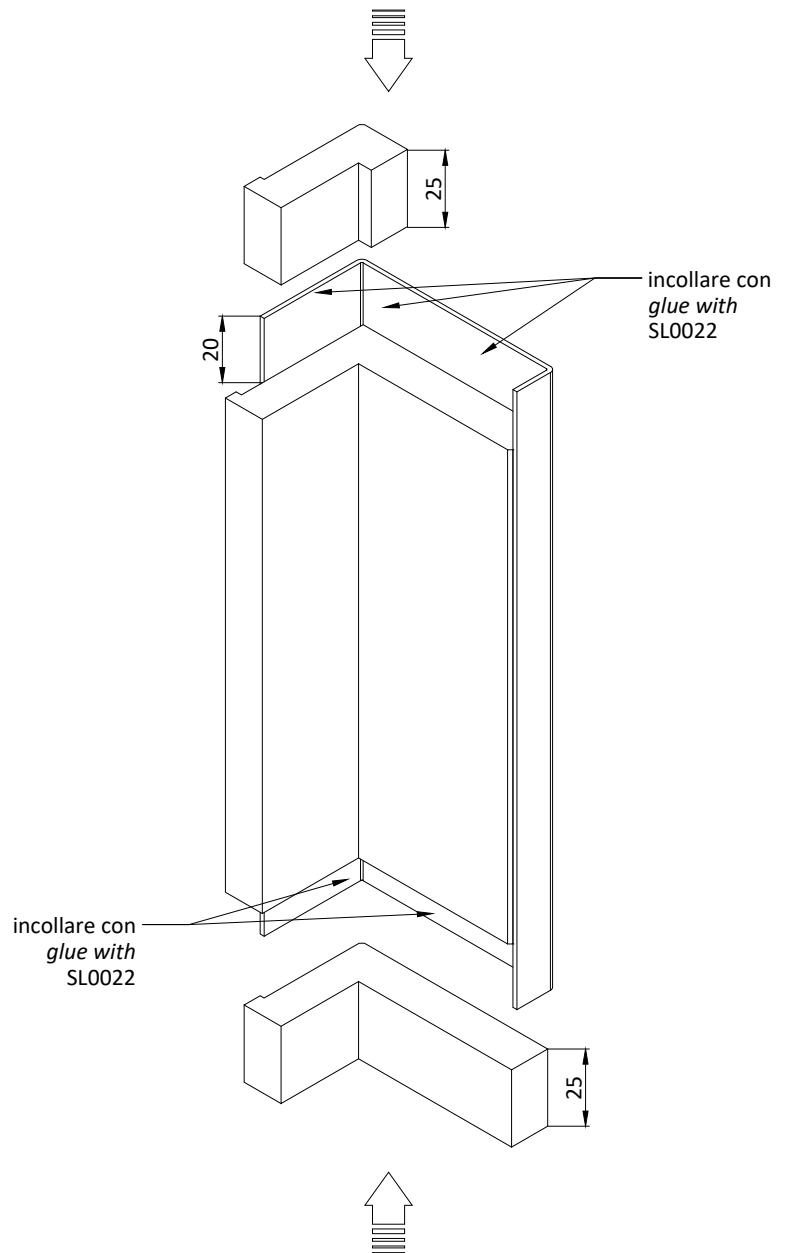
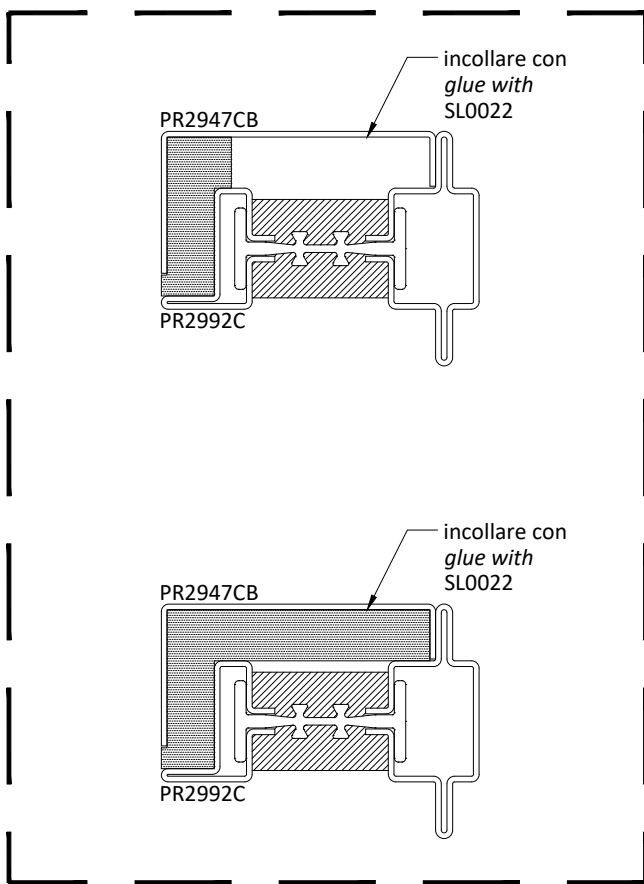
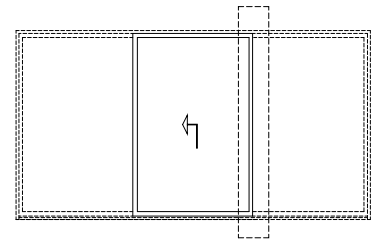
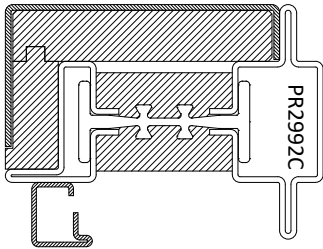



- 1) Profilo metallico | *Metallic profile*
- 2) Estruso in PVC rigido | *Extruded PVC profile*

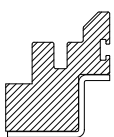
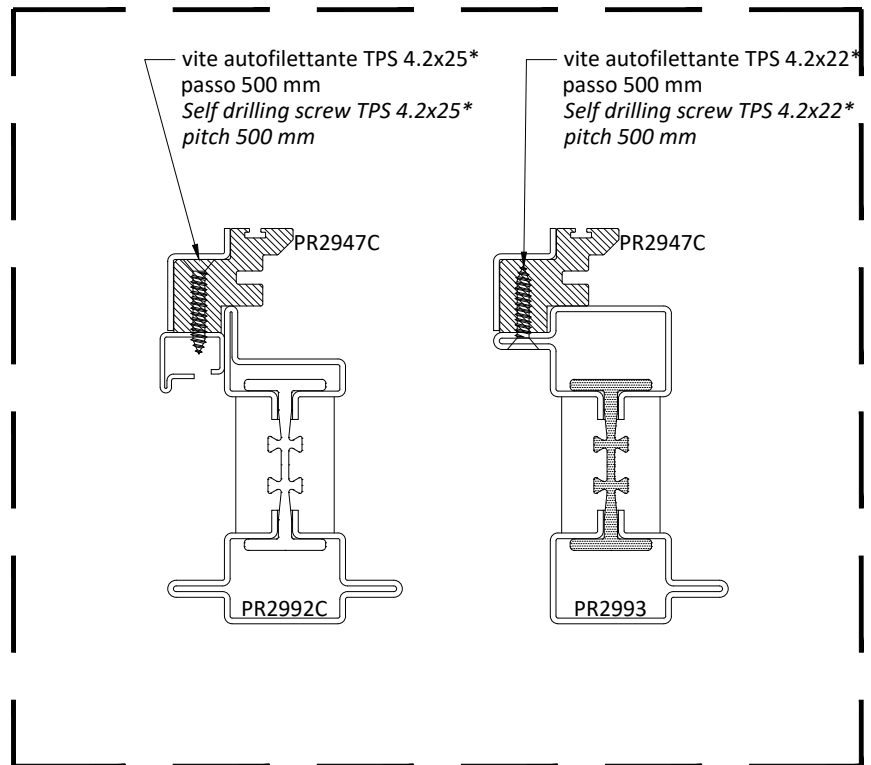
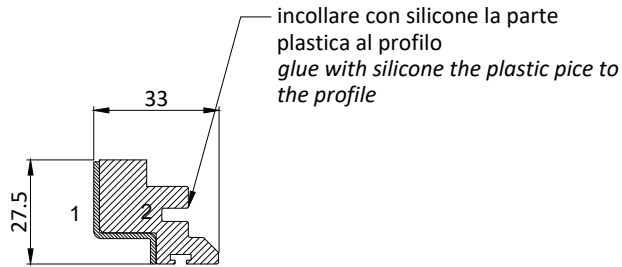
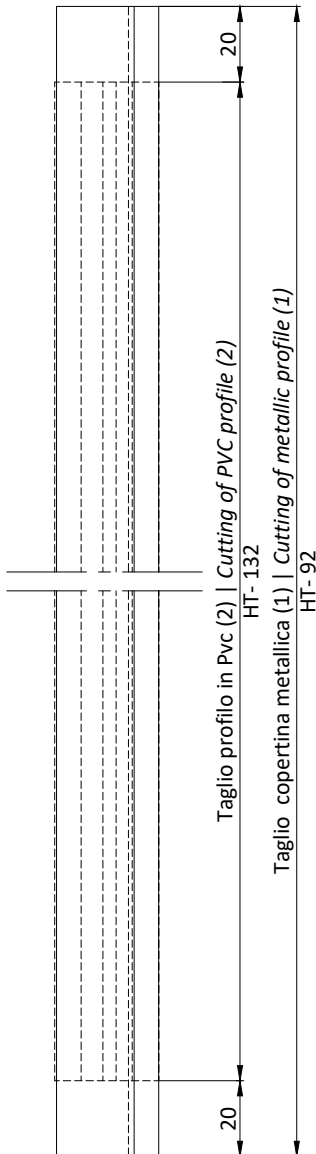
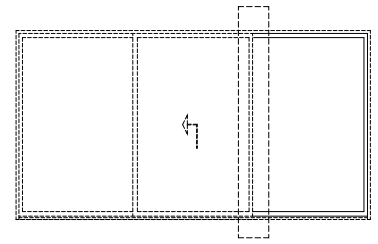

\* viti TPS autofilettante 4.2x22 e 4.2x25 non comprese  
\* screws self tapping TPS 4.2x22 and 4.2x25 not supplied

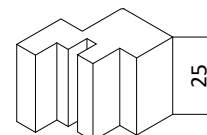
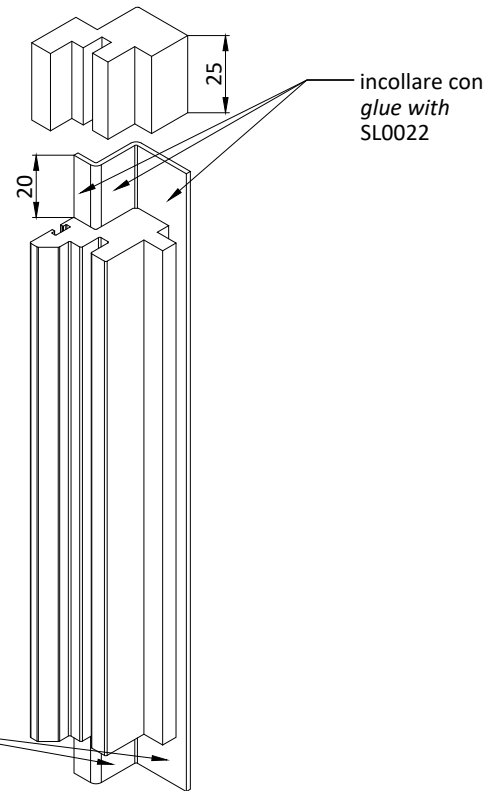
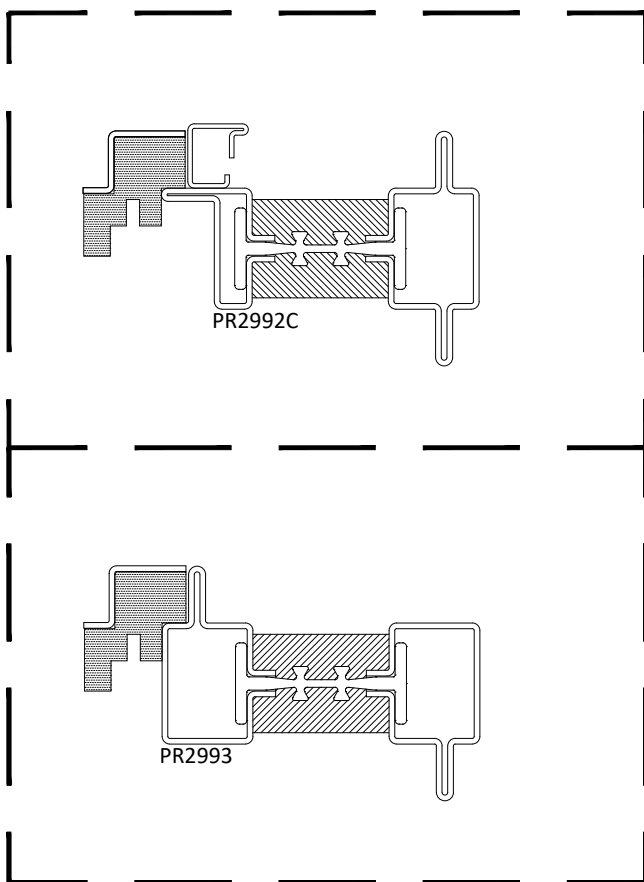
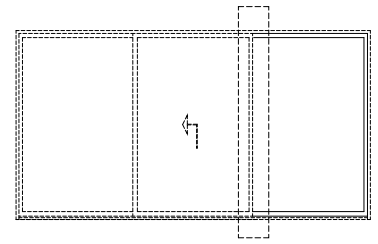

- 1) Profilo metallico | *Metallic profile*
- 2) Estruso in PVC rigido | *Extruded PVC profile*
- 3) Estruso in PVC rigido | *Extruded PVC profile*

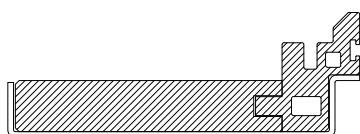
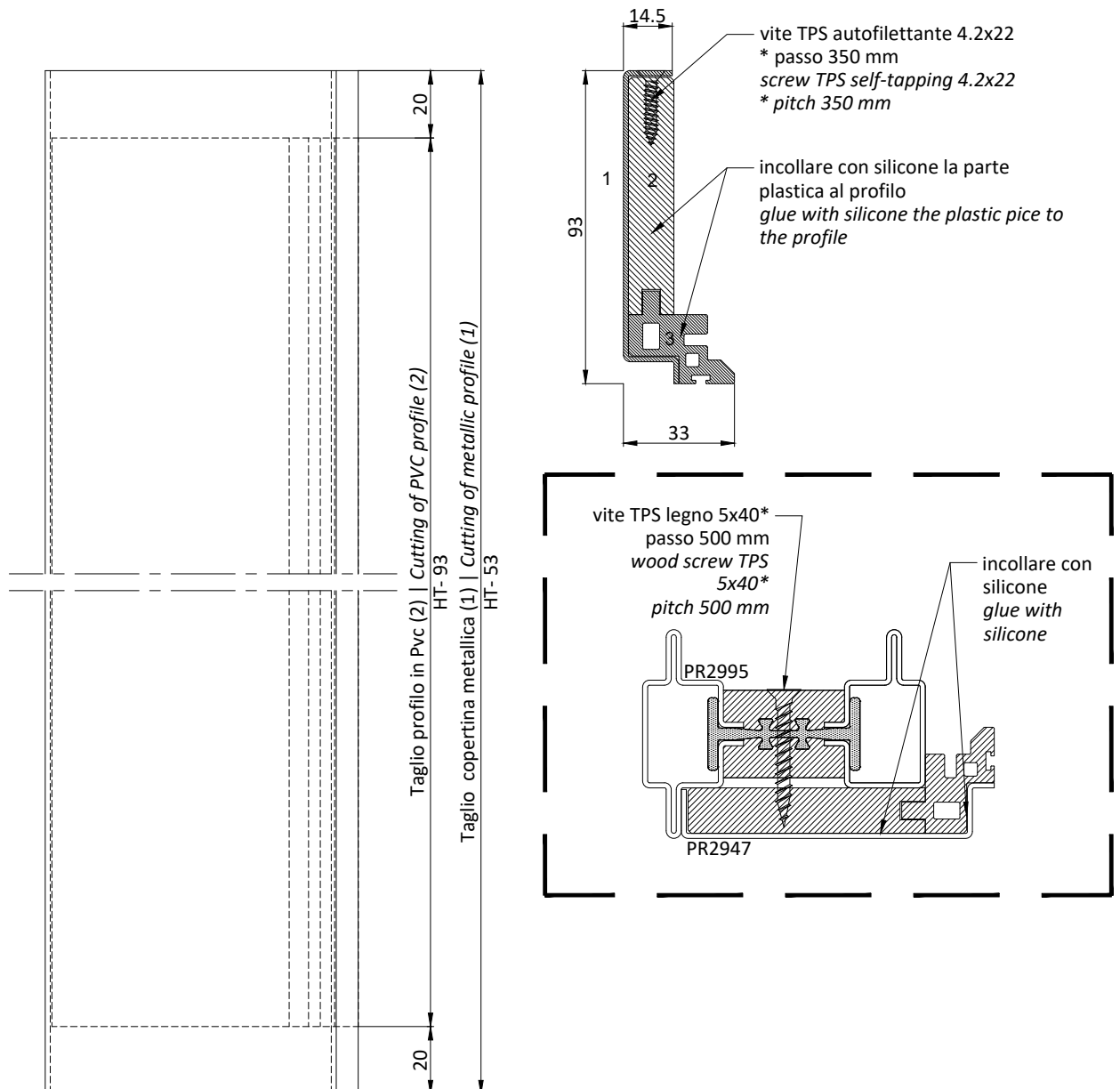
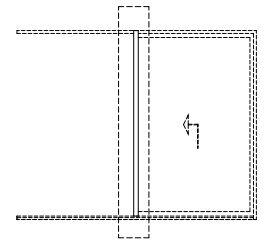

\* viti TPS autofilettante 4.2 x 22 e TPS legno 5x40 non comprese  
\* screws self tapping TPS 4.2 x 22 and wood screws TPS 5X40 not supplied

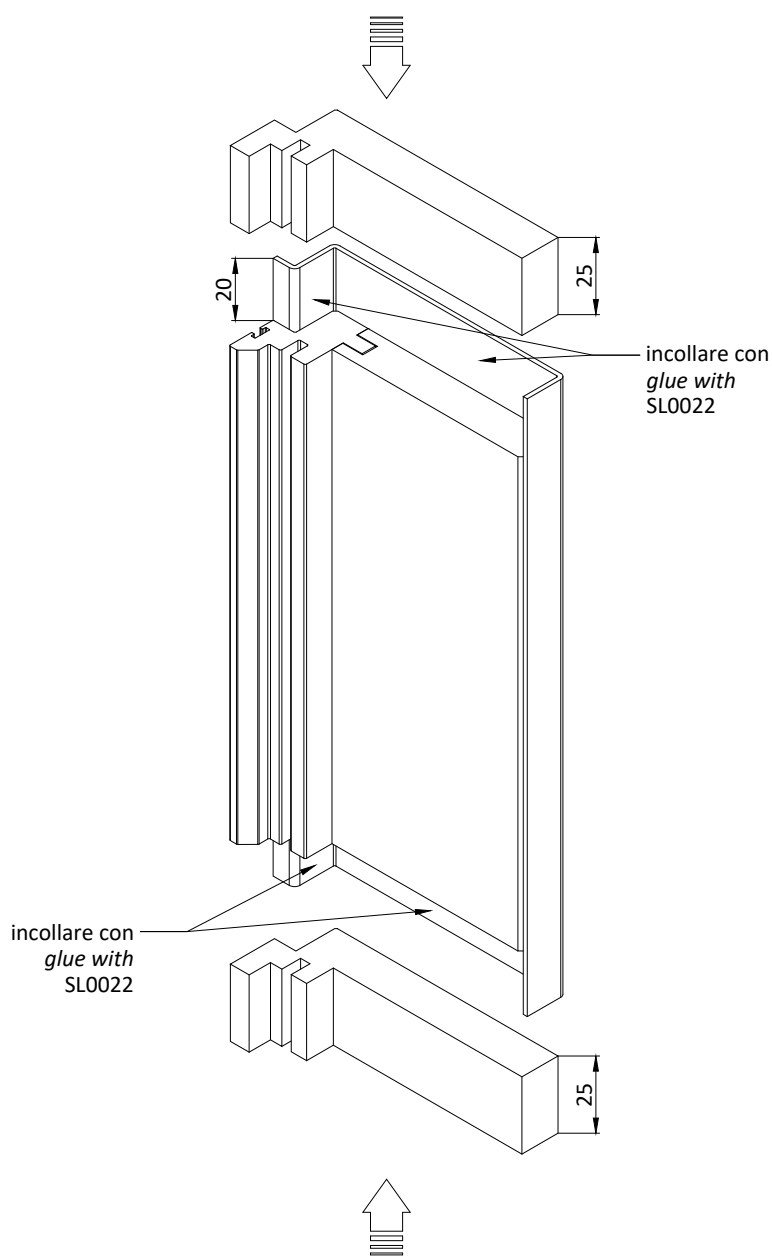
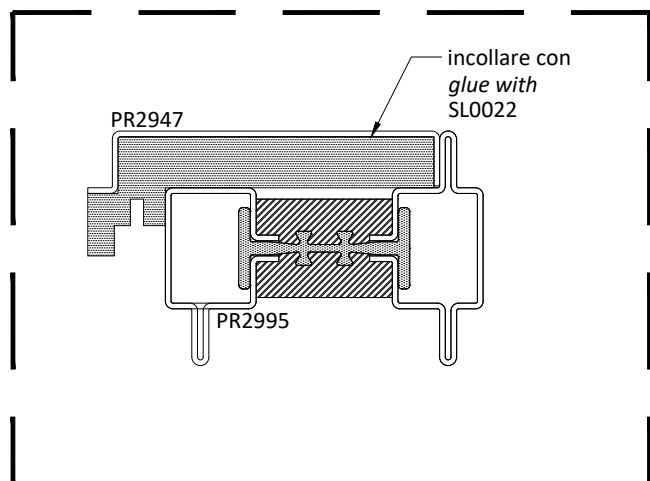
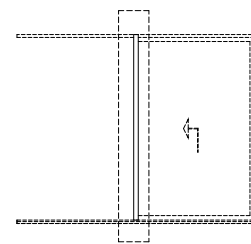

Schema | Type S1

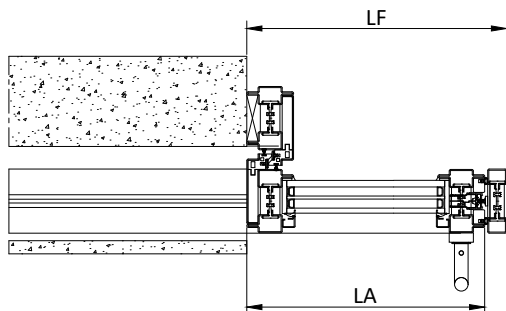
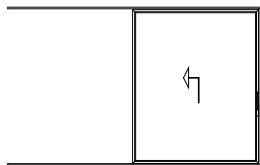

Dimensione anta  
Sash dimension

$LA = LF - 29$        $HA = HT - 92$

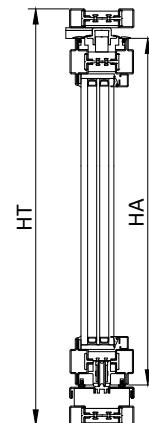

Schema | Type T1

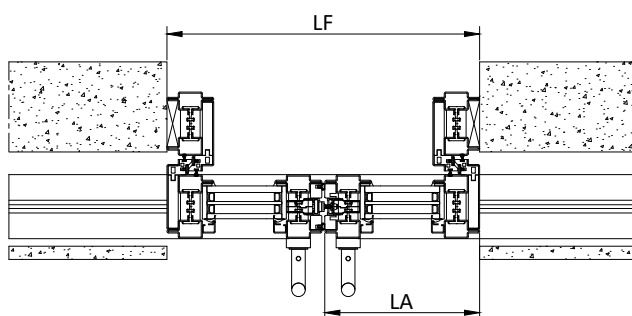
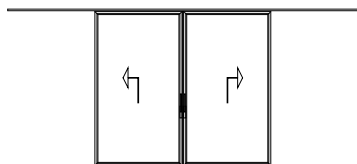

Dimensione anta  
Sash dimension

$LA = LF/2 - 2$        $HA = HT - 92$

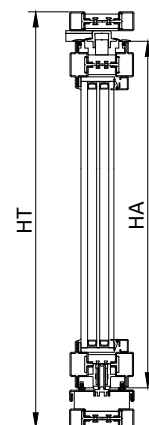

Schema | Type A - B

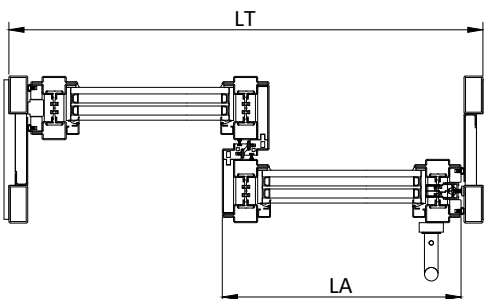
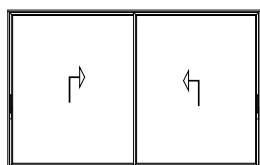

Dimensione anta  
Sash dimension

$LA = LT/2 + 2$        $HA = HT - 92$

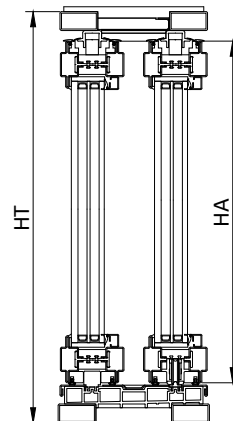

Schema | Type C

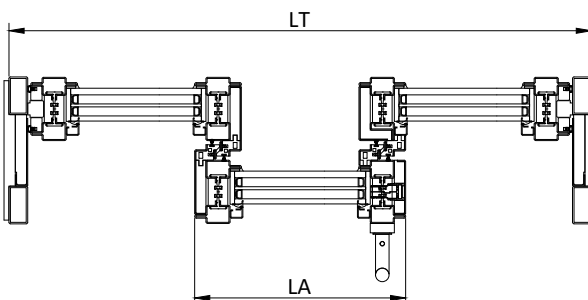
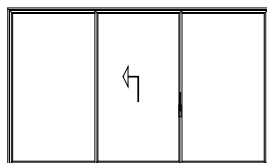

Dimensione anta  
Sash dimension

$LA = LT/3 + 22$        $HA = HT - 92$

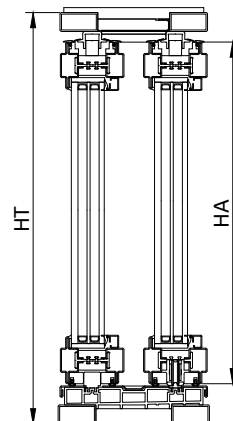

Schema | Type E - F

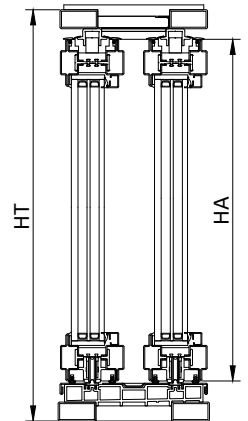
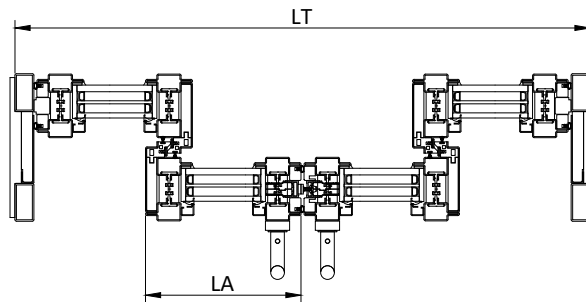
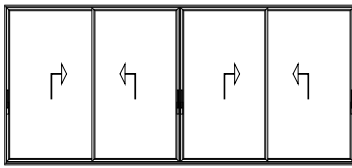

Dimensione anta  
Sash dimension

$LA = LT/4 + 15.5$     $HA = HT - 92$

Schema | Type S2

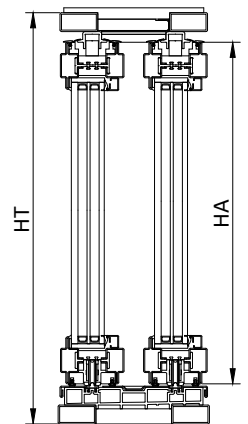
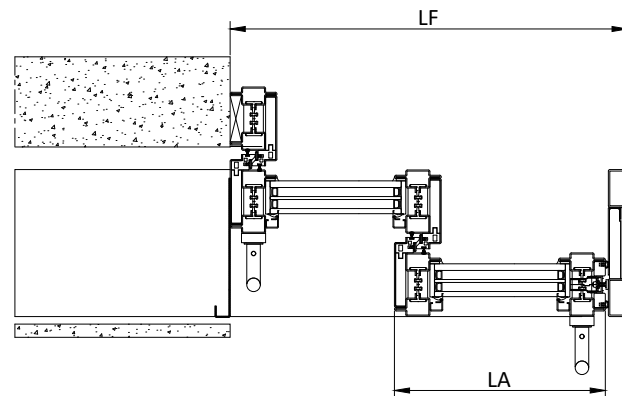
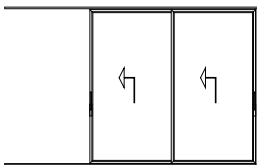

Dimensione anta  
Sash dimension

$LA = LF/2 + 16.5$     $HA = HT - 92$

Schema | Type T2

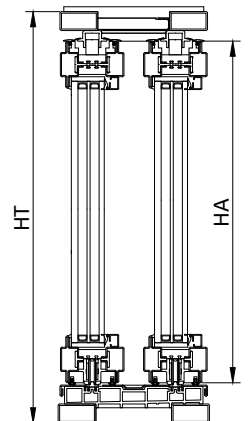
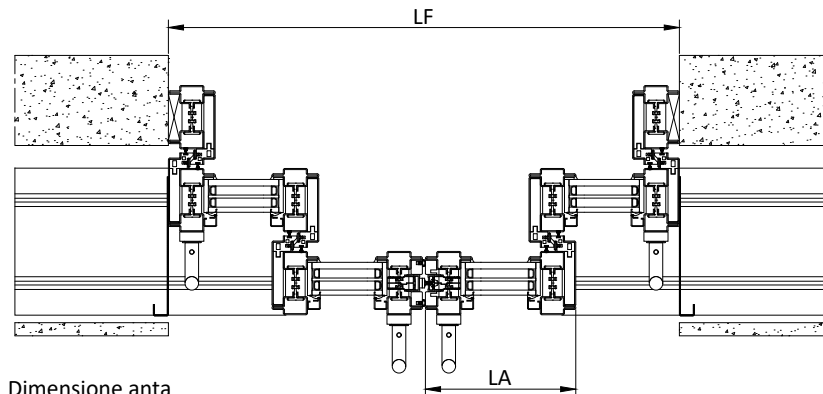
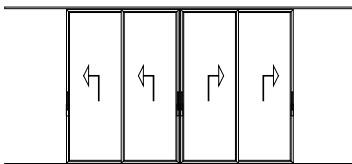

Dimensione anta  
Sash dimension

$LA = LF/4 + 30$     $HA = HT - 92$

Schema | Type A3 - B3 - C3

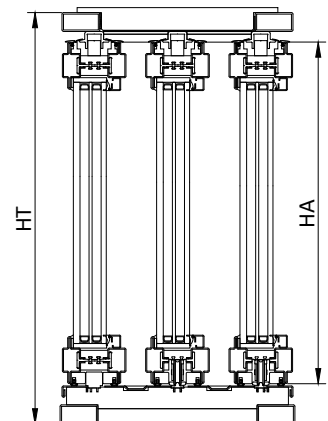
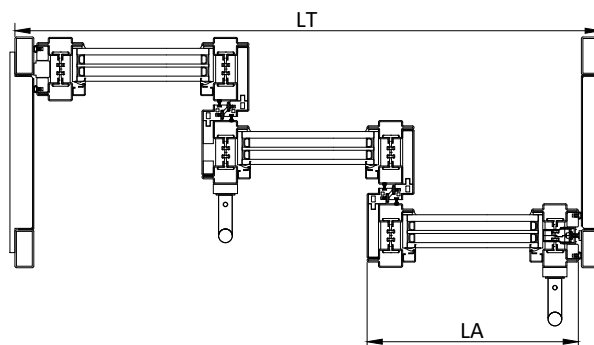
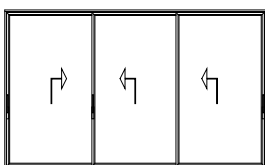

Dimensione anta  
Sash dimension

$LA = LT/3 + 22$     $HA = HT - 92$

Schema | Type E3 - F3

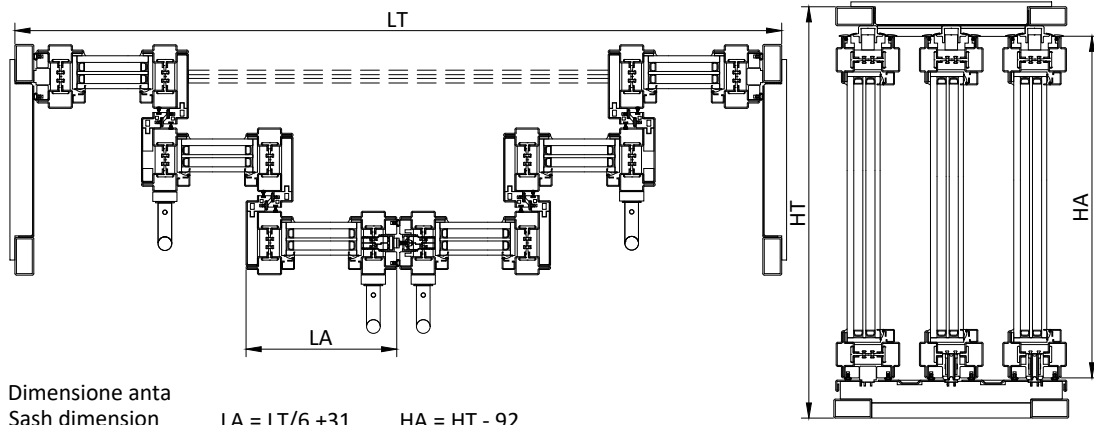
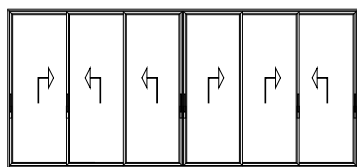

Dimensione anta  
Sash dimension

$LA = LT/6 + 31$      $HA = HT - 92$

Schema | Type E - S3

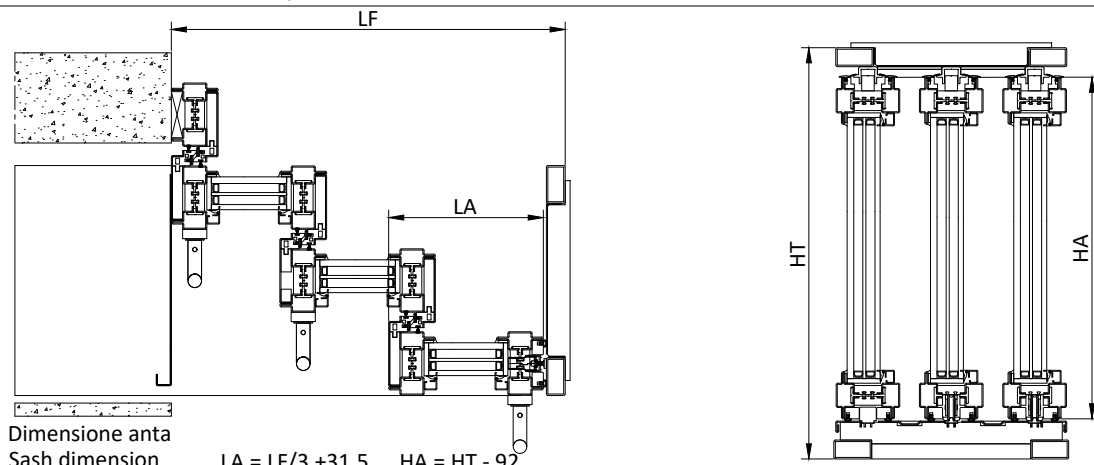
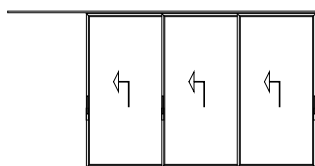

Dimensione anta  
Sash dimension

$LA = LF/3 + 31.5$      $HA = HT - 92$

Schema | Type T3

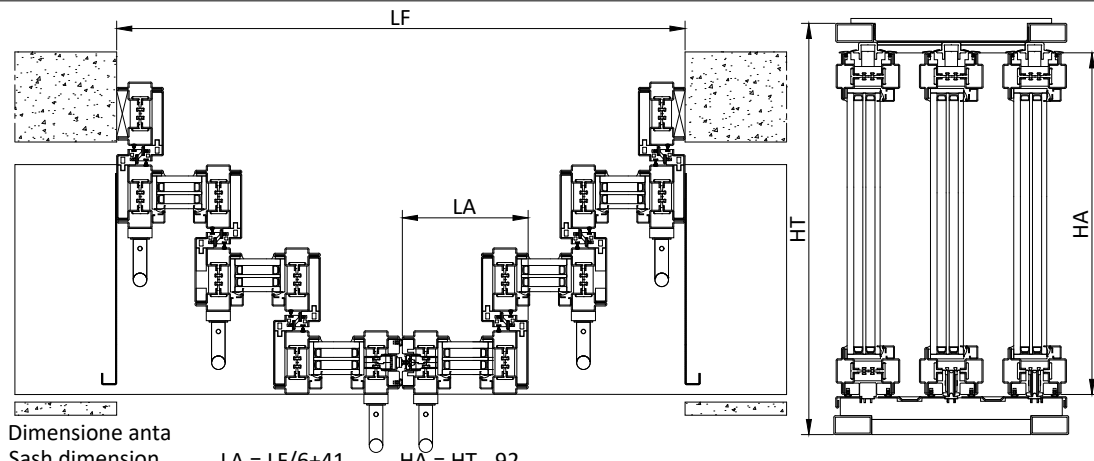
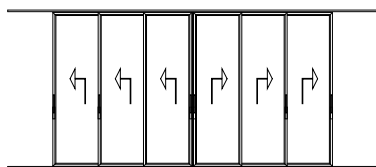

Dimensione anta  
Sash dimension

$LA = LF/6 + 41$      $HA = HT - 92$

Schema | Type A

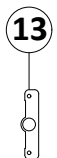
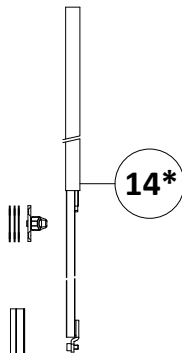
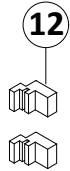
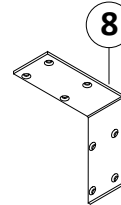
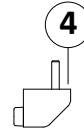
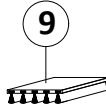
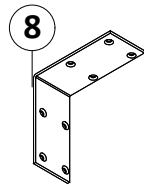
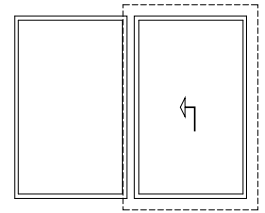

AG2996-7A - DESCRIZIONE   DESCRIPTION AG2996-7A		
1	Carrello anteriore	Front carriage
2	Carrello posteriore	Rear carriage
3	Rostro di chiusura	Locking pin
4	Fermo anta	Bumper stop
5	Barra di unione	Stopper
6	Meccanismo	Mechanism
7	Profilo omega per fissaggio carrelli	Reinforcement profile for fixing carriage
8	Kit rinforzo angoli	Kit reinforcement
9	Tampone centrale di tenuta su guida sup.	Central sealing pad for upper rail
10	Tampone centrale di tenuta su guida inf.	Central sealing pad for bottom rail
11	Tampone di tenuta in neoprene	Neoprene sealing pads
12	Tampone di tenuta in neoprene	Neoprene sealing pads
13	Piastra per fissaggio maniglione singolo	Plate to attach single handle
14*	Prolunga meccanismo	Additional mechanism
15	Vite fissaggio carrelli (CV1140I/M)	Carriage fixing screw (CV1140I/M)

\* Presente solo su kit AG2996-7A.E1  
Only on the kit AG2996-7A.E1

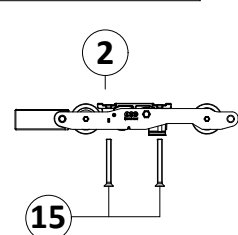
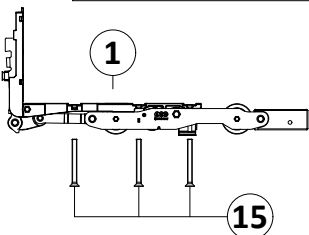
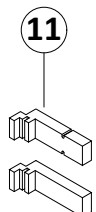
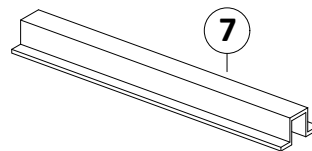
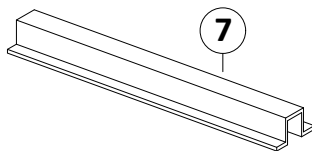
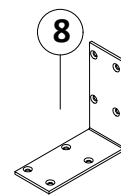
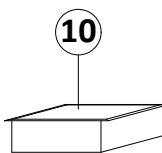
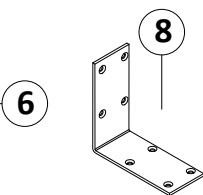



Schema | Type B

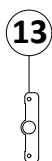
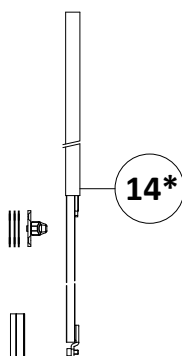
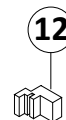
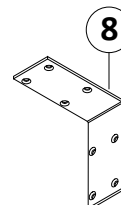
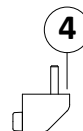
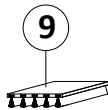
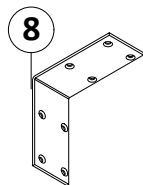
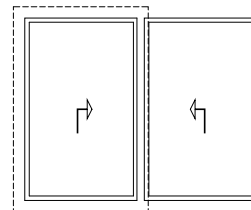

AG2996-7B - DESCRIZIONE   DESCRIPTION AG2996-7B		
1	Carrello anteriore	Front carriage
2	Carrello posteriore	Rear carriage
3	Rostro di chiusura	Locking pin
4	Fermo anta	Bumper stop
5	Barra di unione	Stopper
6	Meccanismo	Mechanism
7	Profilo omega per fissaggio carrelli	Reinforcement profile for fixing carriage
8	Kit rinforzo angoli	Kit reinforcement
9	Tampone centrale di tenuta su guida sup.	Central sealing pad for upper rail
10	Tampone centrale di tenuta su guida inf.	Central sealing pad for bottom rail
11	Tampone di tenuta in neoprene	Neoprene sealing pads
12	Tampone di tenuta in neoprene	Neoprene sealing pads
13	Piastra per fissaggio maniglione singolo	Plate to attach single handle
14*	Prolunga meccanismo	Additional mechanism
15	Vite fissaggio carrelli (CV1140I/M)	Carriage fixing screw (CV1140I/M)

\* Presente solo su kit AG2996-7B.E1  
Only on the kit AG2996-7B.E1

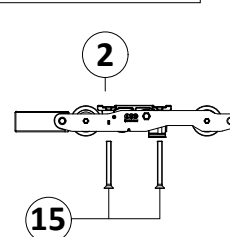
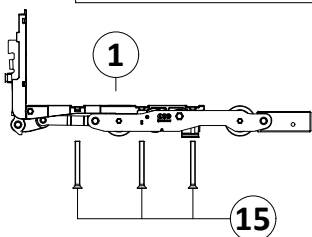
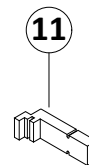
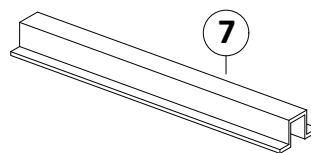
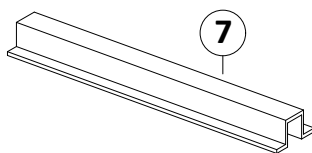
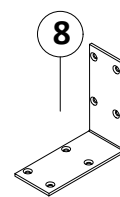
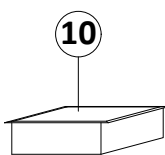
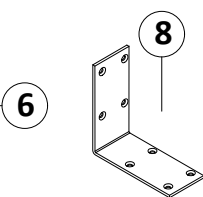

Schema | Type B

kg  
250

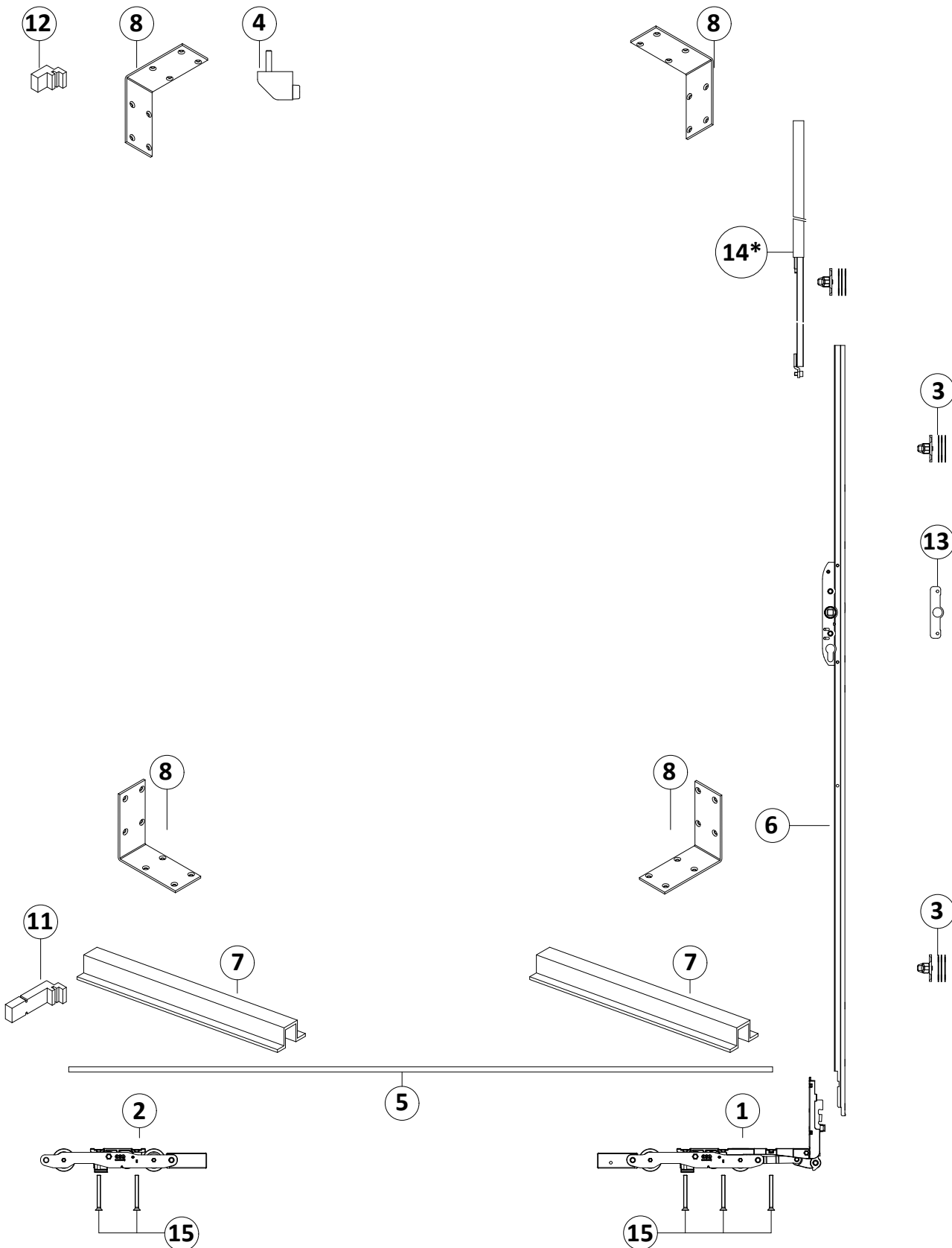
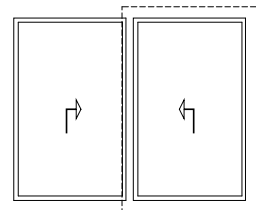

Schema | Type C

kg  
250

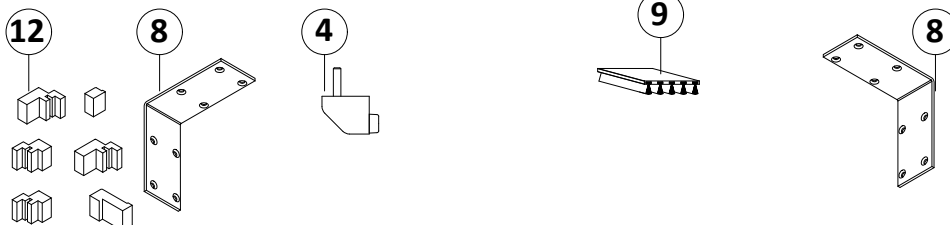
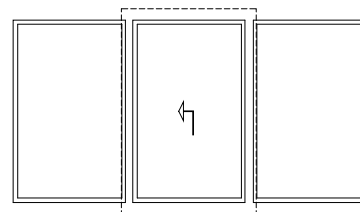

AG2996-7C - DESCRIZIONE   DESCRIPTION AG2996-7C		
1	Carrello anteriore	Front carriage
2	Carrello posteriore	Rear carriage
3	Rostro di chiusura	Locking pin
4	Fermo anta	Bumper stop
5	Barra di unione	Stopper
6	Meccanismo	Mechanism
7	Profilo omega per fissaggio carrelli	Reinforcement profile for fixing carriage
8	Kit rinforzo angoli	Kit reinforcement
9	Tampone centrale di tenuta su guida sup.	Central sealing pad for upper rail
10	Tampone centrale di tenuta su guida inf.	Central sealing pad for bottom rail
11	Tampone di tenuta in neoprene	Neoprene sealing pads
12	Tampone di tenuta in neoprene	Neoprene sealing pads
13	Piastra per fissaggio maniglione singolo	Plate to attach single handle
15	Vite fissaggio carrelli (CV1140I/M)	Carriage fixing screw (CV1140I/M)

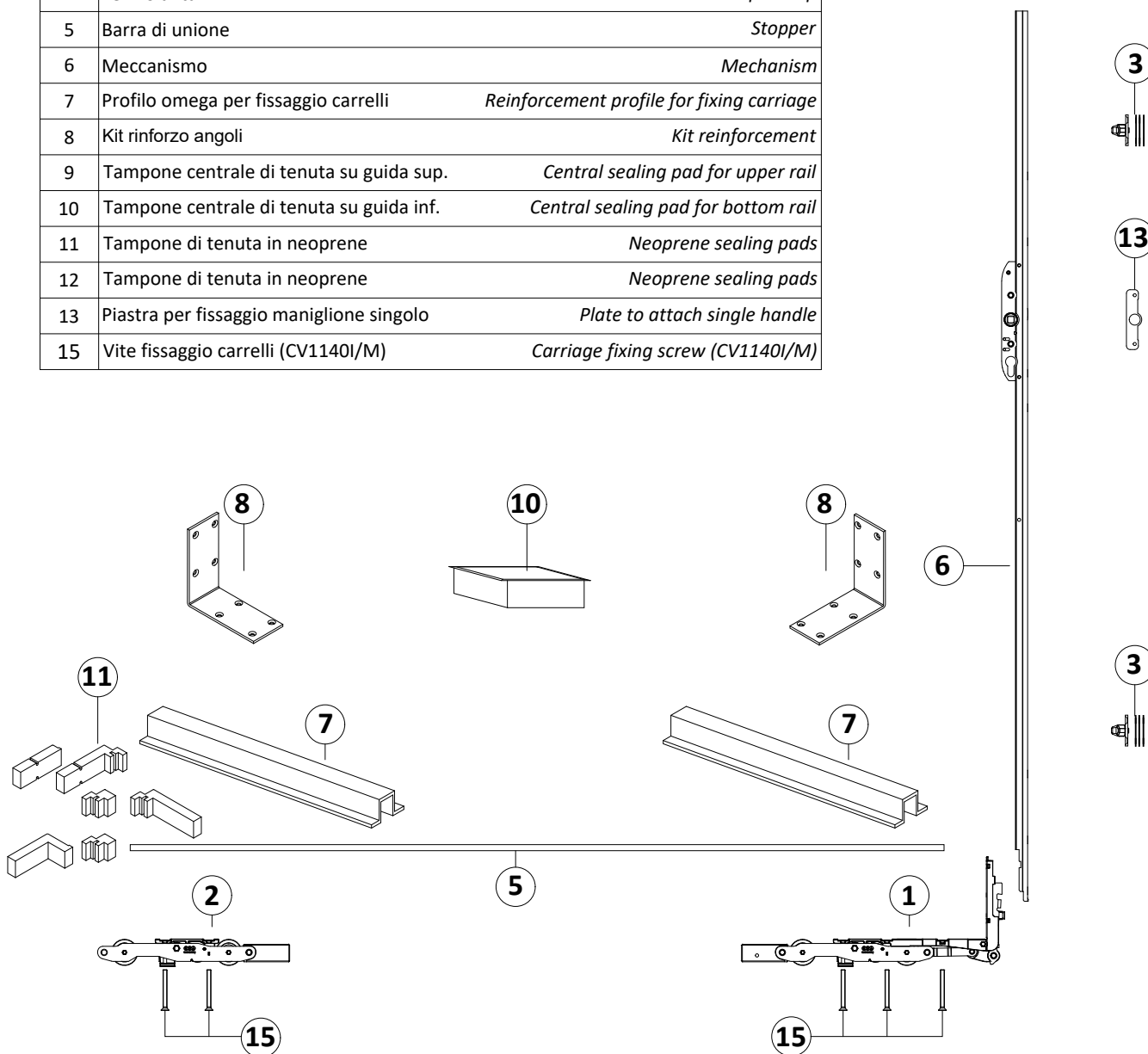

Schema | Type E

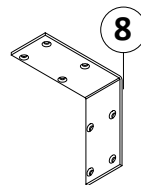
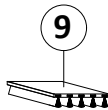
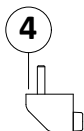
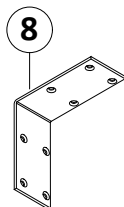
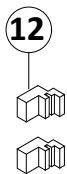
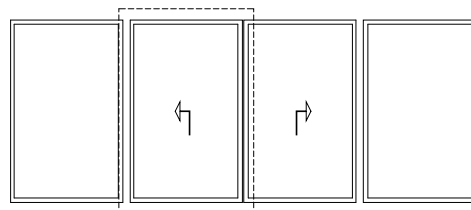

AG2996E - DESCRIZIONE   DESCRIPTION AG2996E	
1	Carrello anteriore <i>Front carriage</i>
2	Carrello posteriore <i>Rear carriage</i>
3	Rostro di chiusura <i>Locking pin</i>
4	Fermo anta <i>Bumper stop</i>
5	Barra di unione <i>Stopper</i>
6	Meccanismo <i>Mechanism</i>
7	Profilo omega per fissaggio carrelli <i>Reinforcement profile for fixing carriage</i>
8	Kit rinforzo angoli <i>Kit reinforcement</i>
9	Tampone centrale di tenuta su guida sup. <i>Central sealing pad for upper rail</i>
10	Tampone centrale di tenuta su guida inf. <i>Central sealing pad for bottom rail</i>
11	Tampone di tenuta in neoprene <i>Neoprene sealing pads</i>
12	Tampone di tenuta in neoprene <i>Neoprene sealing pads</i>
13	Piastra per fissaggio maniglione singolo <i>Plate to attach single handle</i>
14*	Prolunga meccanismo <i>Additional mechanism</i>
15	Vite fissaggio carrelli (CV1140I/M) <i>Carriage fixing screw (CV1140I/M)</i>

\* Presente solo su kit AG2996E.E1  
Only an the kit AG2996E.E1

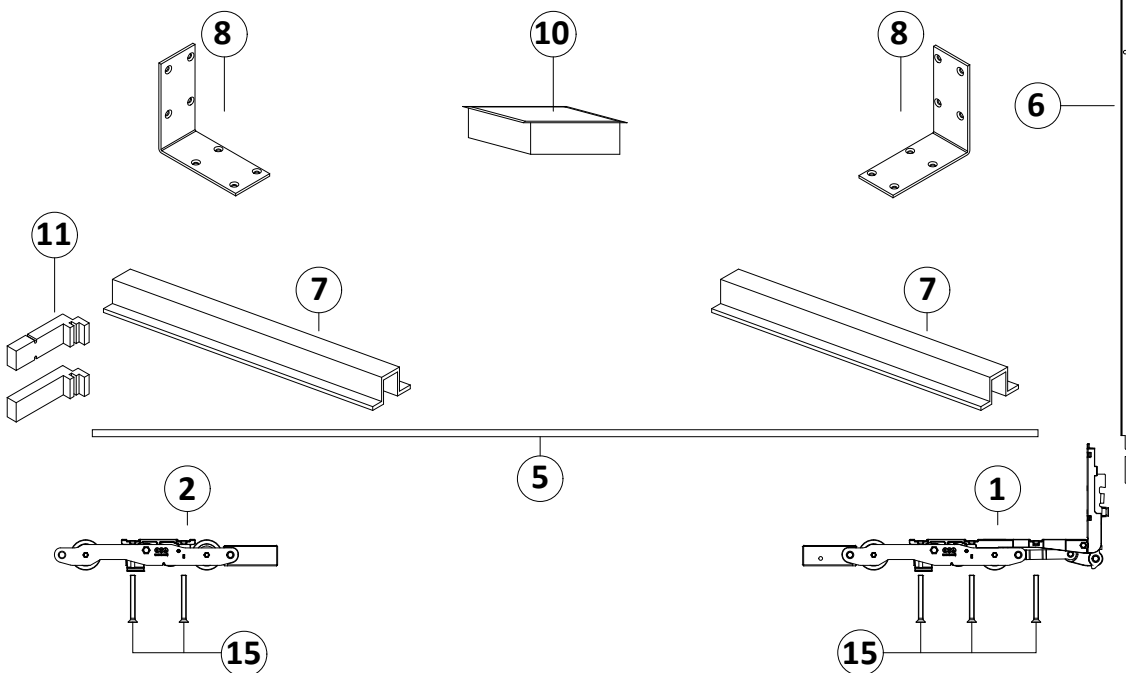

Schema | Type E

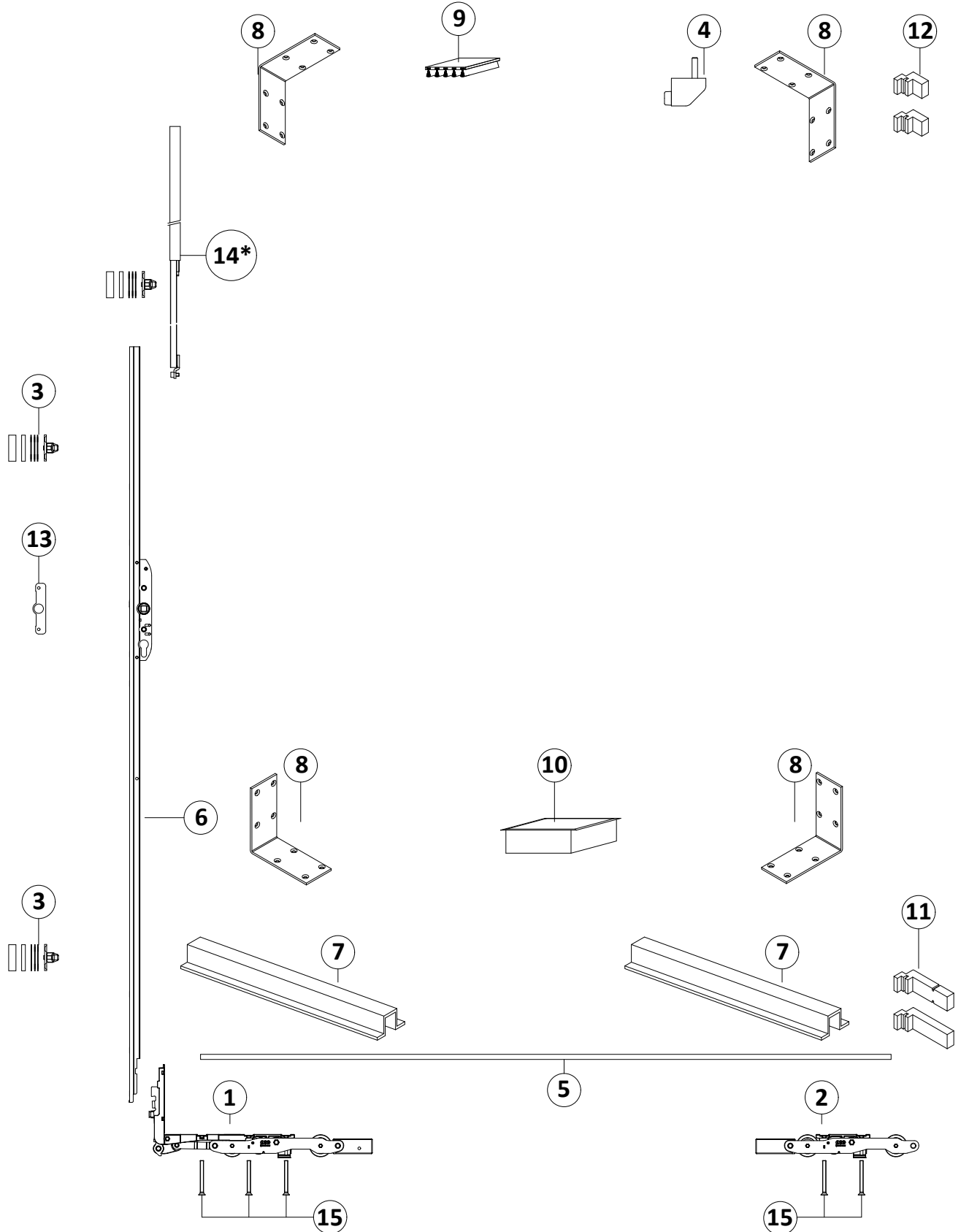
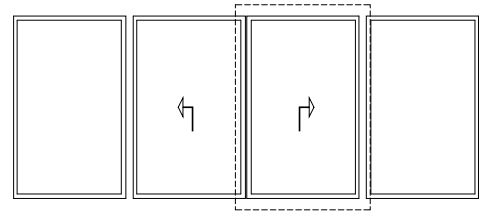

Schema | Type F

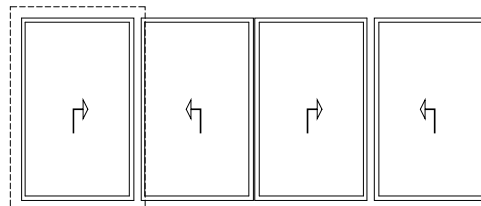

8

9

4

8

12

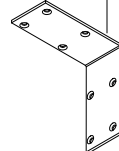

14\*

AG2996F - DESCRIZIONE   DESCRIPTION AG2996F	
1	Carrello anteriore <i>Front carriage</i>
2	Carrello posteriore <i>Rear carriage</i>
3	Rostro di chiusura <i>Locking pin</i>
4	Fermo anta <i>Bumper stop</i>
5	Barra di unione <i>Stopper</i>
6	Meccanismo <i>Mechanism</i>
7	Profilo omega per fissaggio carrelli <i>Reinforcement profile for fixing carriage</i>
8	Kit rinforzo angoli <i>Kit reinforcement</i>
9	Tampone centrale di tenuta su guida sup. <i>Central sealing pad for upper rail</i>
10	Tampone centrale di tenuta su guida inf. <i>Central sealing pad for bottom rail</i>
11	Tampone di tenuta in neoprene <i>Neoprene sealing pads</i>
12	Tampone di tenuta in neoprene <i>Neoprene sealing pads</i>
13	Piastra per fissaggio maniglione singolo <i>Plate to attach single handle</i>
14*	Prolunga meccanismo <i>Additional mechanism</i>
15	Vite fissaggio carrelli (CV1140I/M) <i>Carriage fixing screw (CV1140I/M)</i>

\* Presente solo su kit AG2996F.E1  
Only on the kit AG2996F.E1

3

13

3

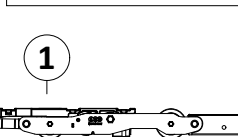
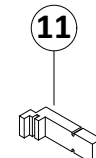
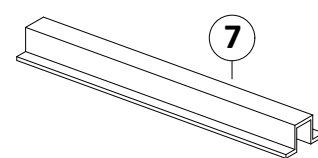
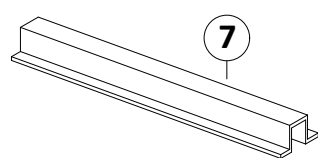
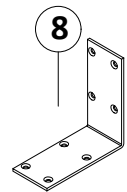
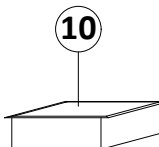
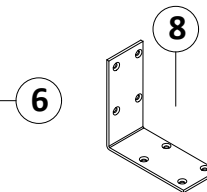

5

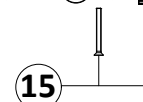
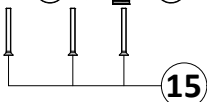
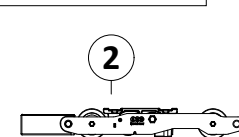

Schema | Type F

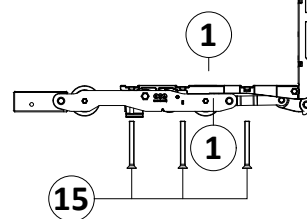
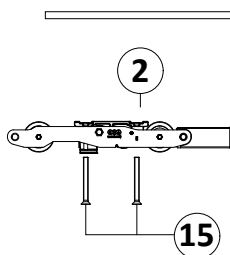
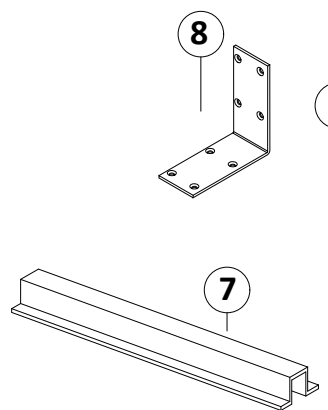
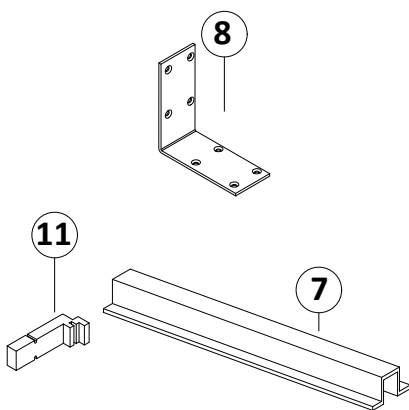
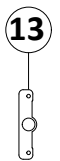
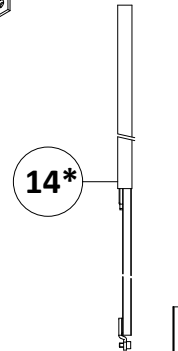
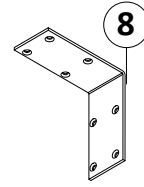
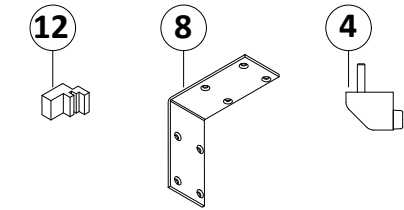
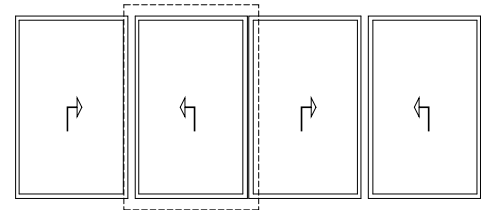

Schema | Type F

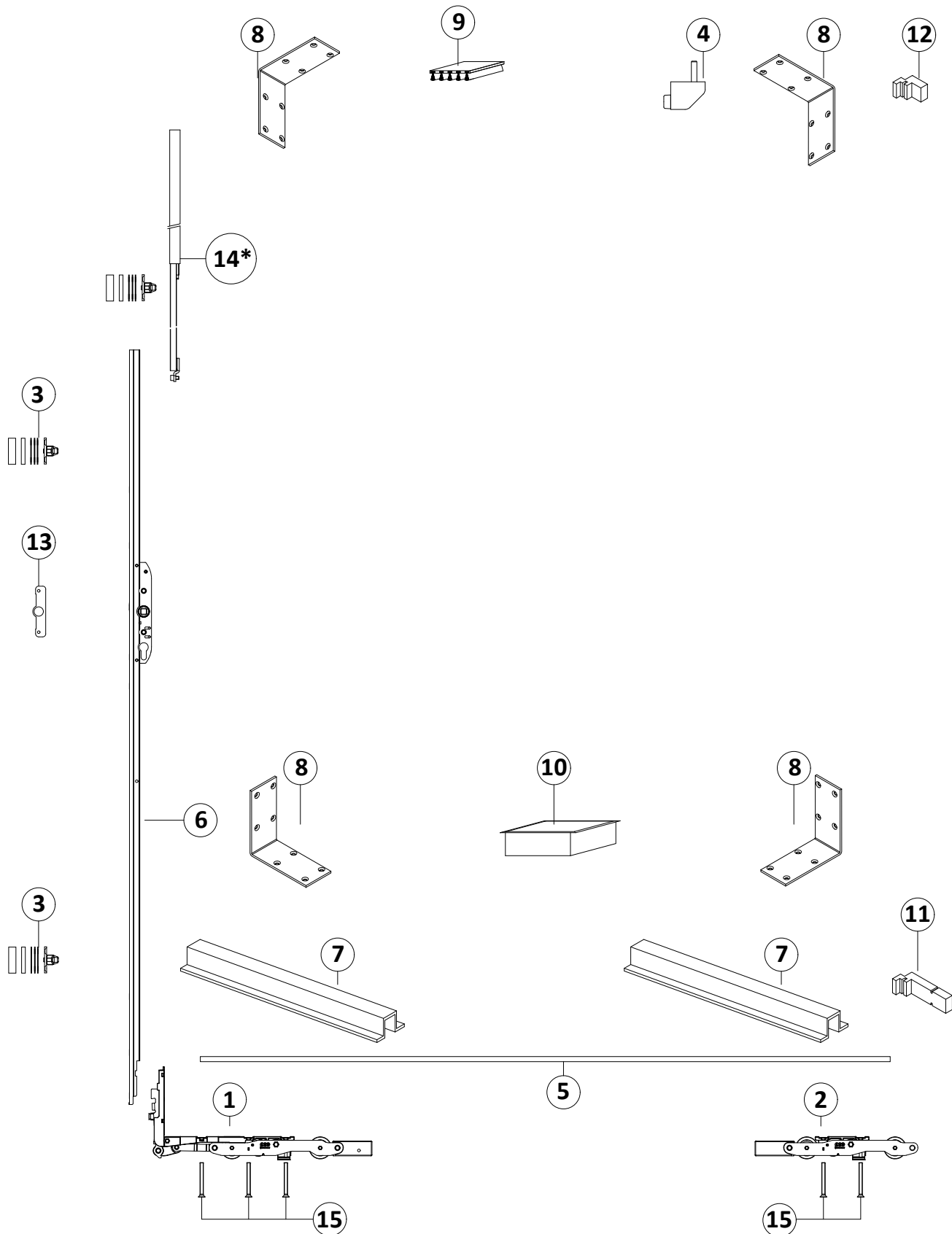
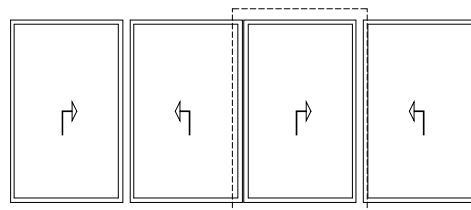



Schema | Type F

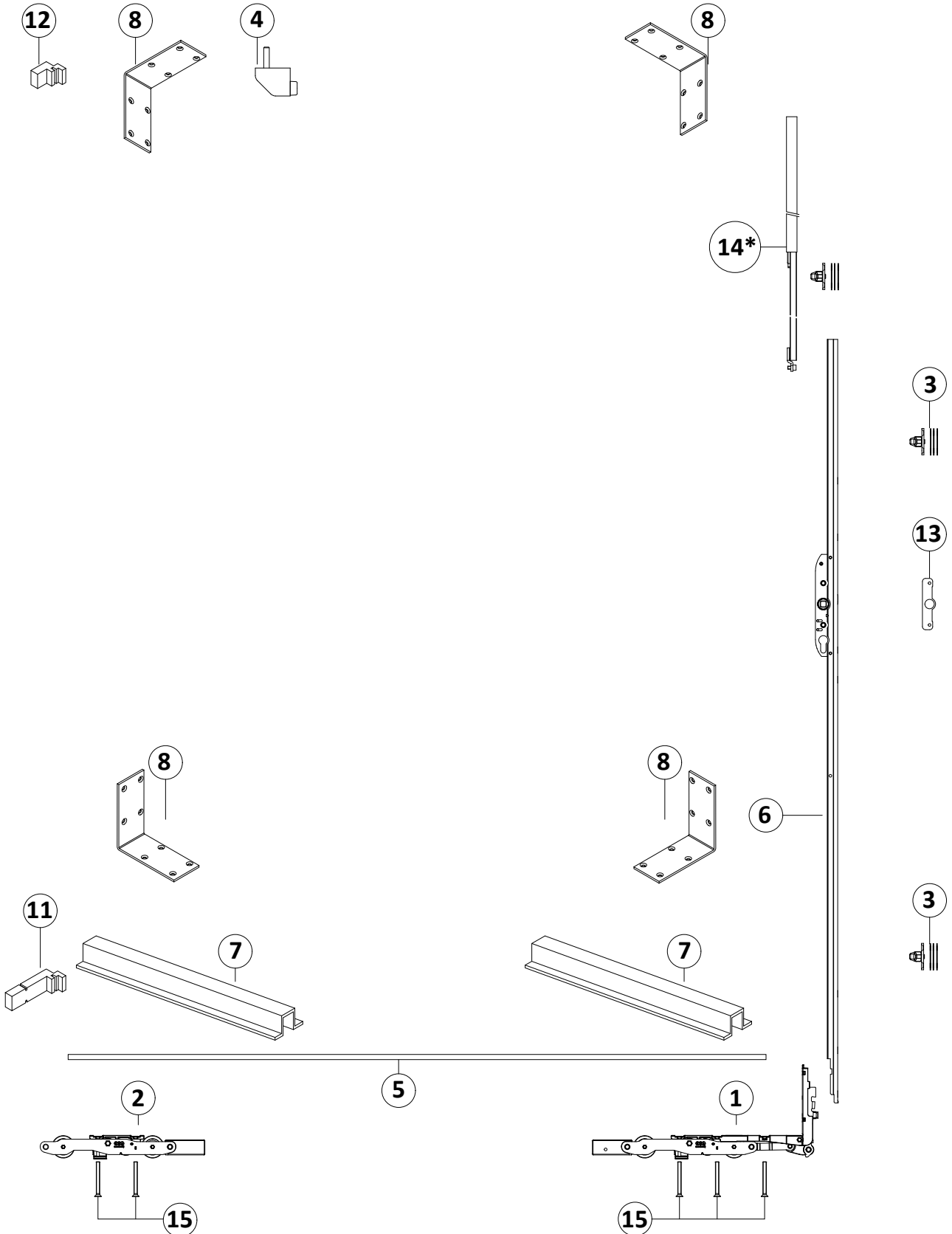
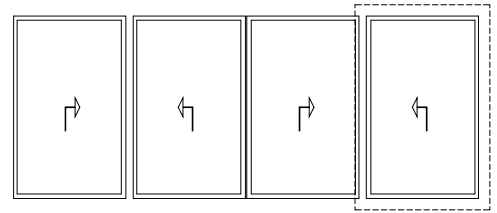

Schema | Type S1

kg  
250

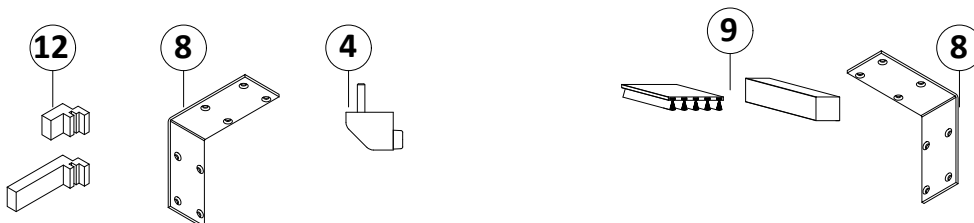
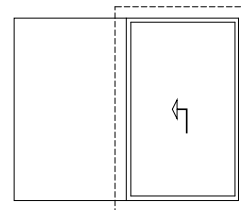

AG2996-7S1 - DESCRIZIONE   DESCRIPTION AG2996-7S1		
1	Carrello anteriore	Front carriage
2	Carrello posteriore	Rear carriage
3	Rostro di chiusura	Locking pin
4	Fermo anta	Bumper stop
5	Barra di unione	Stopper
6	Meccanismo	Mechanism
7	Profilo omega per fissaggio carrelli	Reinforcement profile for fixing carriage
8	Kit rinforzo angoli	Kit reinforcement
9	Tampone centrale di tenuta su guida sup.	Central sealing pad for upper rail
10	Tampone centrale di tenuta su guida inf.	Central sealing pad for bottom rail
11	Tampone di tenuta in neoprene	Neoprene sealing pads
12	Tampone di tenuta in neoprene	Neoprene sealing pads
13	Piastra per fissaggio maniglione singolo	Plate to attach single handle
14*	Prolunga meccanismo	Additional mechanism
15	Vite fissaggio carrelli (CV1140I/M)	Carriage fixing screw (CV1140I/M)

\* Presente solo su kit AG2996-7S1.E1  
Only on the kit AG2996-7S1.E1

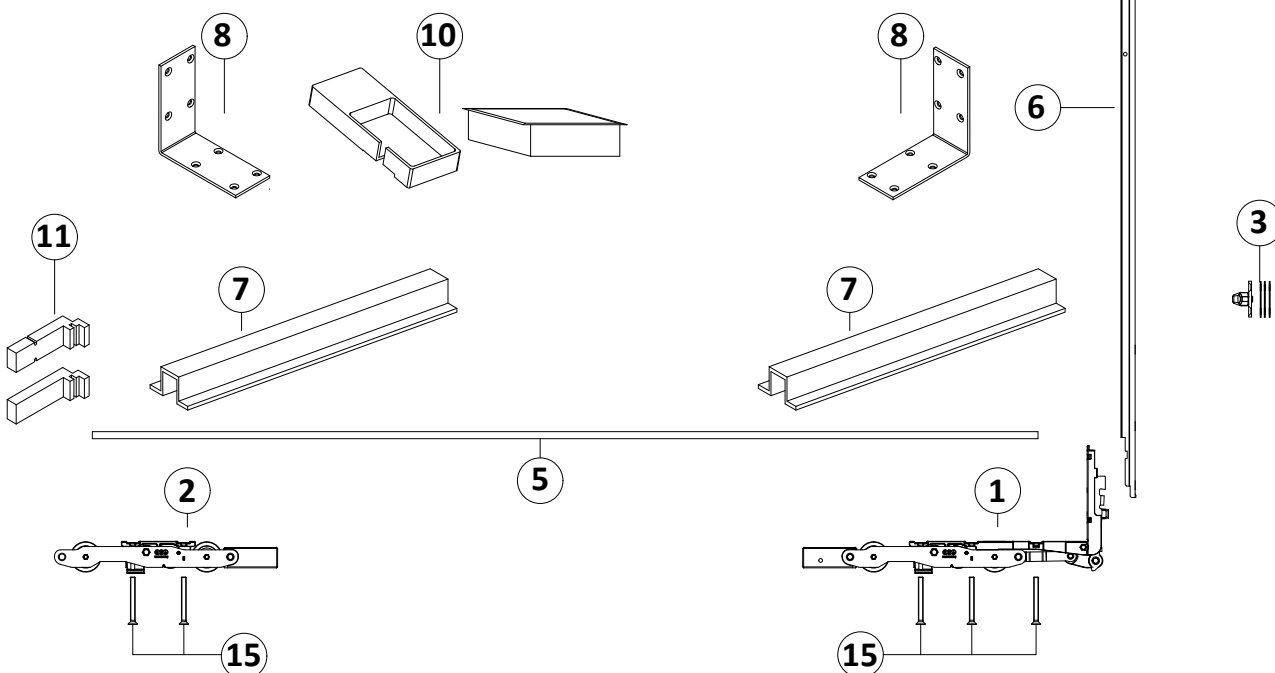

Schema | Type T1

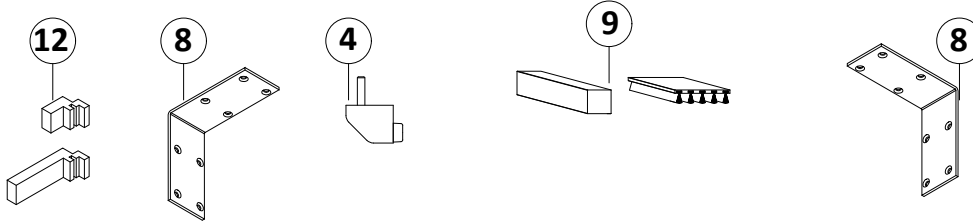
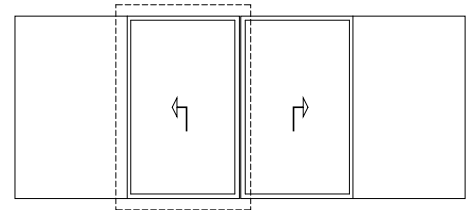

AG2996T1 - DESCRIZIONE   DESCRIPTION AG2996T1		
1	Carrello anteriore	Front carriage
2	Carrello posteriore	Rear carriage
3	Rostro di chiusura	Locking pin
4	Fermo anta	Bumper stop
5	Barra di unione	Stopper
6	Meccanismo	Mechanism
7	Profilo omega per fissaggio carrelli	Reinforcement profile for fixing carriage
8	Kit rinforzo angoli	Kit reinforcement
9	Tampone centrale di tenuta su guida sup.	Central sealing pad for upper rail
10	Tampone centrale di tenuta su guida inf.	Central sealing pad for bottom rail
11	Tampone di tenuta in neoprene	Neoprene sealing pads
12	Tampone di tenuta in neoprene	Neoprene sealing pads
13	Piastra per fissaggio maniglione singolo	Plate to attach single handle
14*	Prolunga meccanismo	Additional mechanism
15	Vite fissaggio carrelli (CV1140I/M)	Carriage fixing screw (CV1140I/M)

\* Presente solo su kit AG2996T1.E1  
Only an the kit AG2996T1.E1

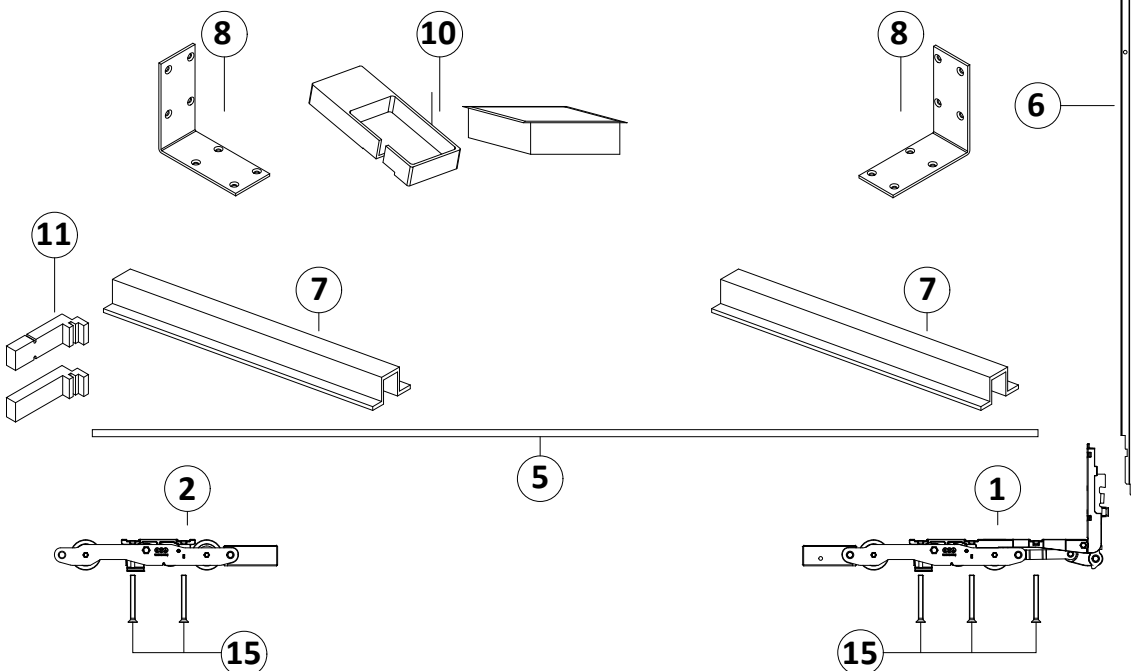

Schema | Type T1

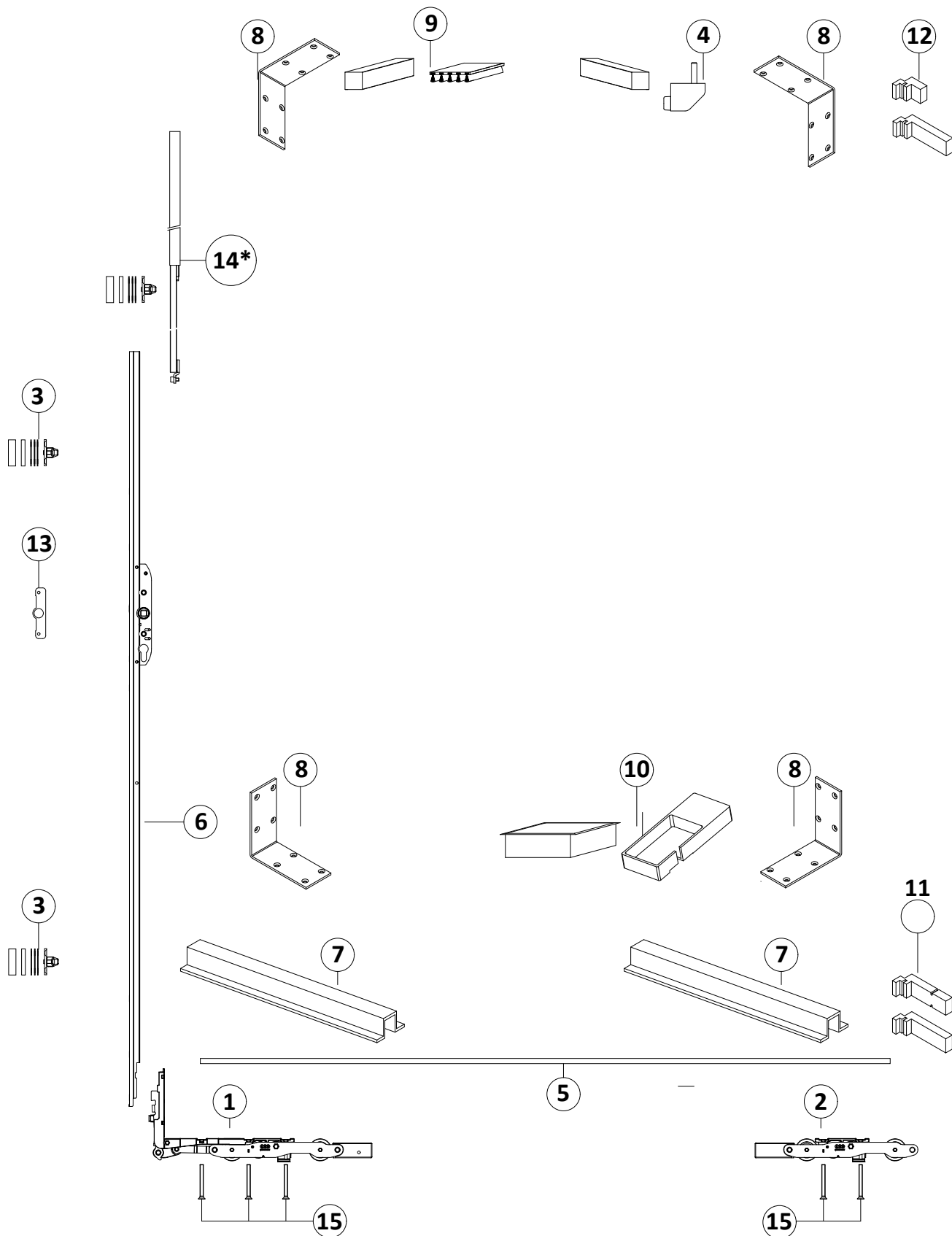
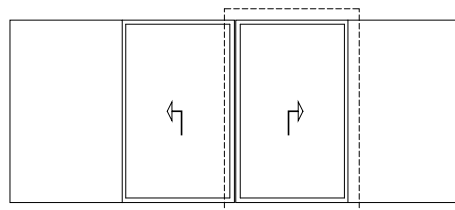

Schema | Type A3

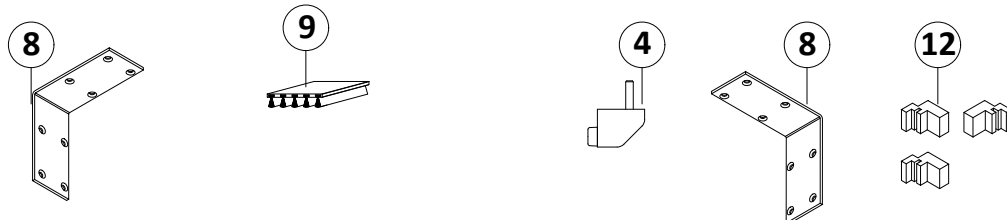
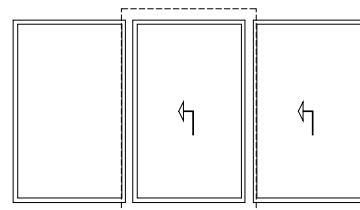

AG2996-7A3 - DESCRIZIONE   DESCRIPTION AG2996-7A3		
1	Carrello anteriore	Front carriage
2	Carrello posteriore	Rear carriage
3	Rostro di chiusura	Locking pin
4	Fermo anta	Bumper stop
5	Barra di unione	Stopper
6	Meccanismo	Mechanism
7	Profilo omega per fissaggio carrelli	Reinforcement profile for fixing carriage
8	Kit rinforzo angoli	Kit reinforcement
9	Tampone centrale di tenuta su guida sup.	Central sealing pad for upper rail
10	Tampone centrale di tenuta su guida inf.	Central sealing pad for bottom rail
11	Tampone di tenuta in neoprene	Neoprene sealing pads
12	Tampone di tenuta in neoprene	Neoprene sealing pads
13	Piastra per fissaggio maniglione singolo	Plate to attach single handle
15	Vite fissaggio carrelli (CV1140I/M)	Carriage fixing screw (CV1140I/M)

\* Presente solo su kit AG2996-7A3.E1  
Only on the kit AG2996-7A3.E1

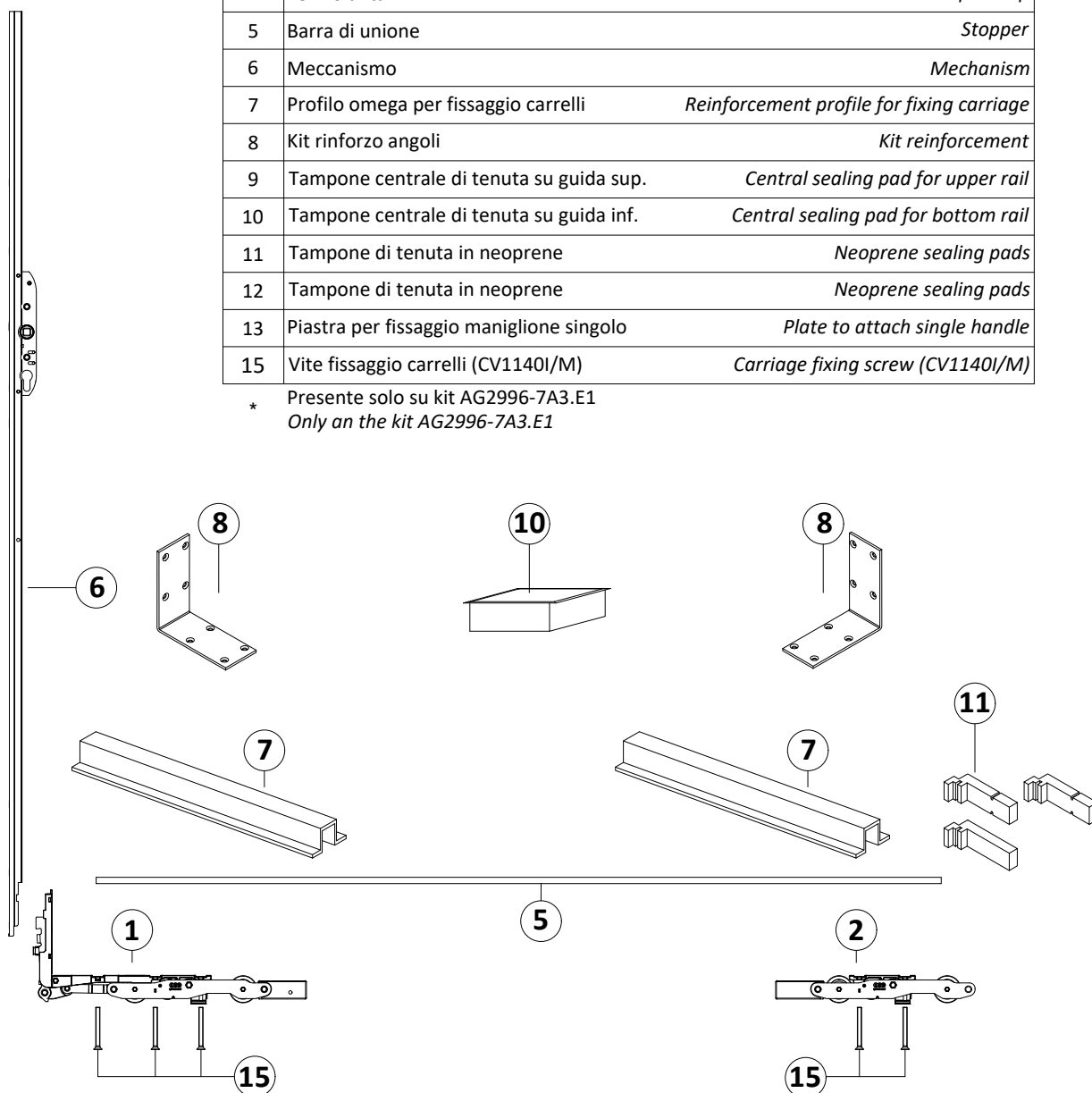
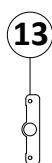

Schema | Type A3

kg  
250

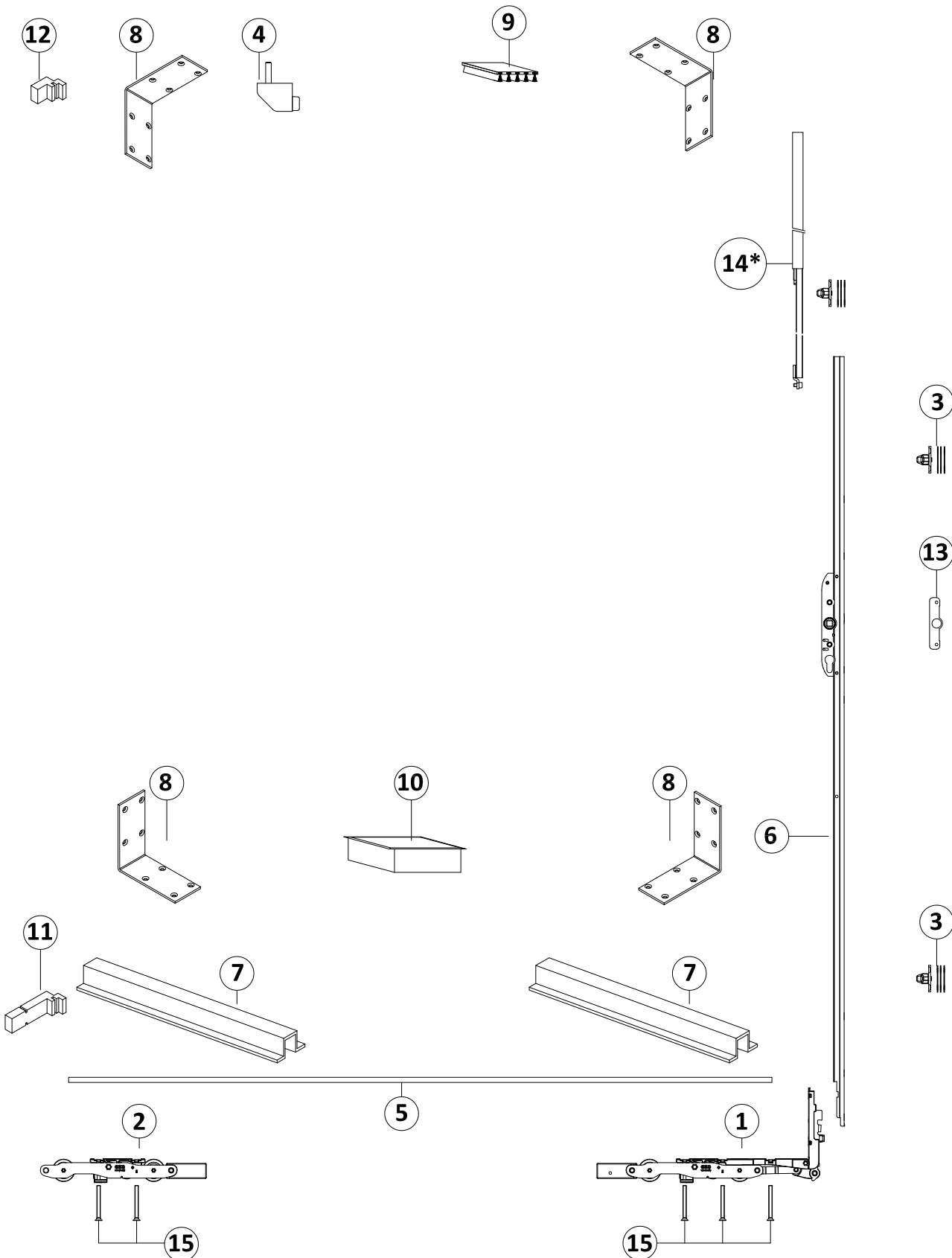
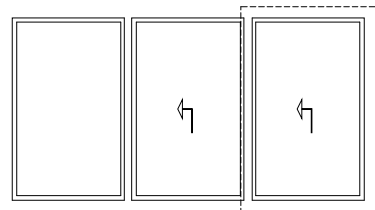

Schema | Type B3

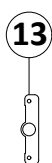
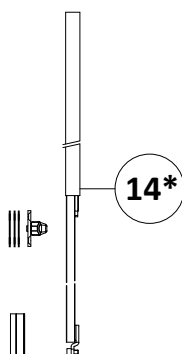
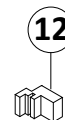
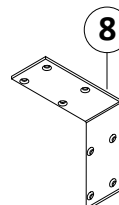
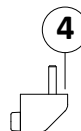
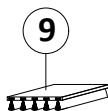
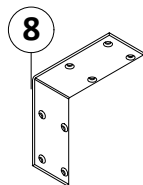
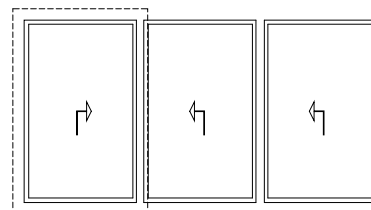

AG2996-7B3 - DESCRIZIONE   DESCRIPTION AG2996-7B3		
1	Carrello anteriore	Front carriage
2	Carrello posteriore	Rear carriage
3	Rostro di chiusura	Locking pin
4	Fermo anta	Bumper stop
5	Barra di unione	Stopper
6	Meccanismo	Mechanism
7	Profilo omega per fissaggio carrelli	Reinforcement profile for fixing carriage
8	Kit rinforzo angoli	Kit reinforcement
9	Tampone centrale di tenuta su guida sup.	Central sealing pad for upper rail
10	Tampone centrale di tenuta su guida inf.	Central sealing pad for bottom rail
11	Tampone di tenuta in neoprene	Neoprene sealing pads
12	Tampone di tenuta in neoprene	Neoprene sealing pads
13	Piastra per fissaggio maniglione singolo	Plate to attach single handle
14*	Prolunga meccanismo	Additional mechanism
15	Vite fissaggio carrelli (CV1140I/M)	Carriage fixing screw (CV1140I/M)

\* Presente solo su kit AG2996-7B3.E1  
Only on the kit AG2996-7B3.E1

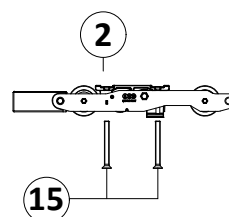
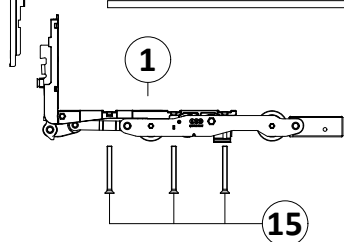
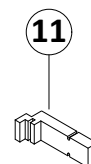
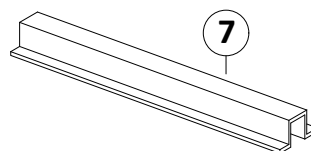
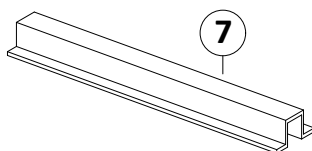
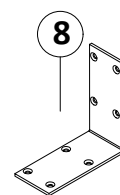
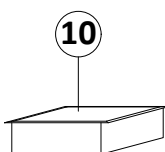
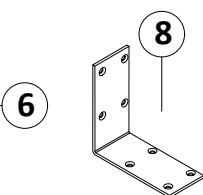

Schema | Type B3

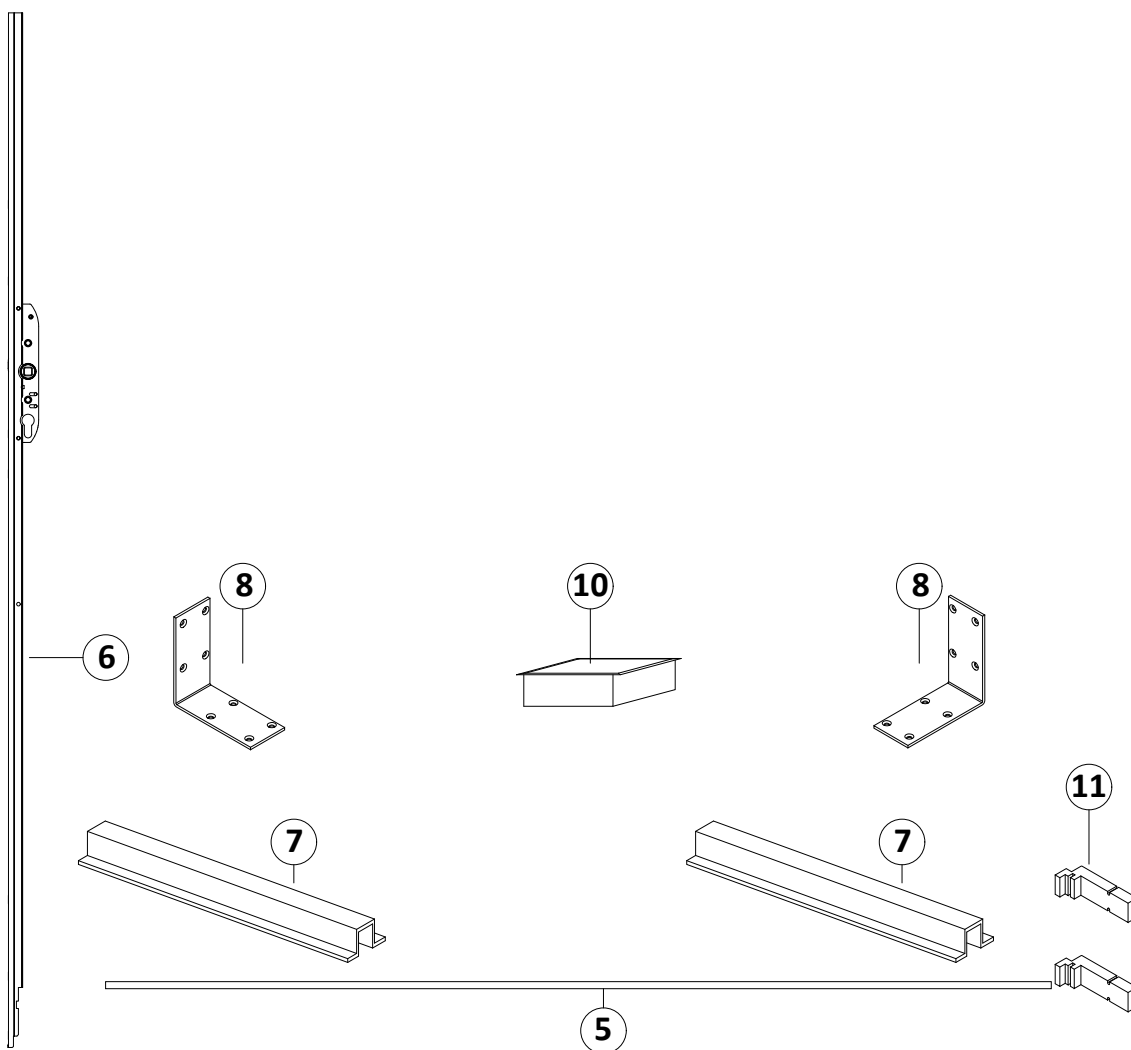
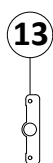
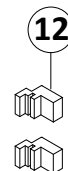
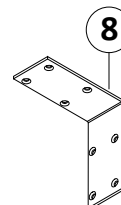
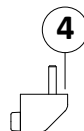
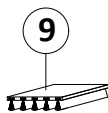
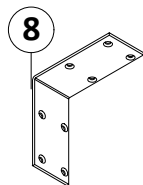
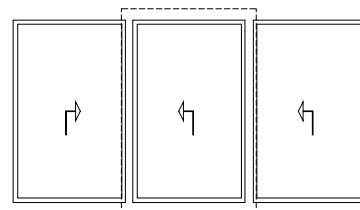



Schema | Type B3

kg  
250

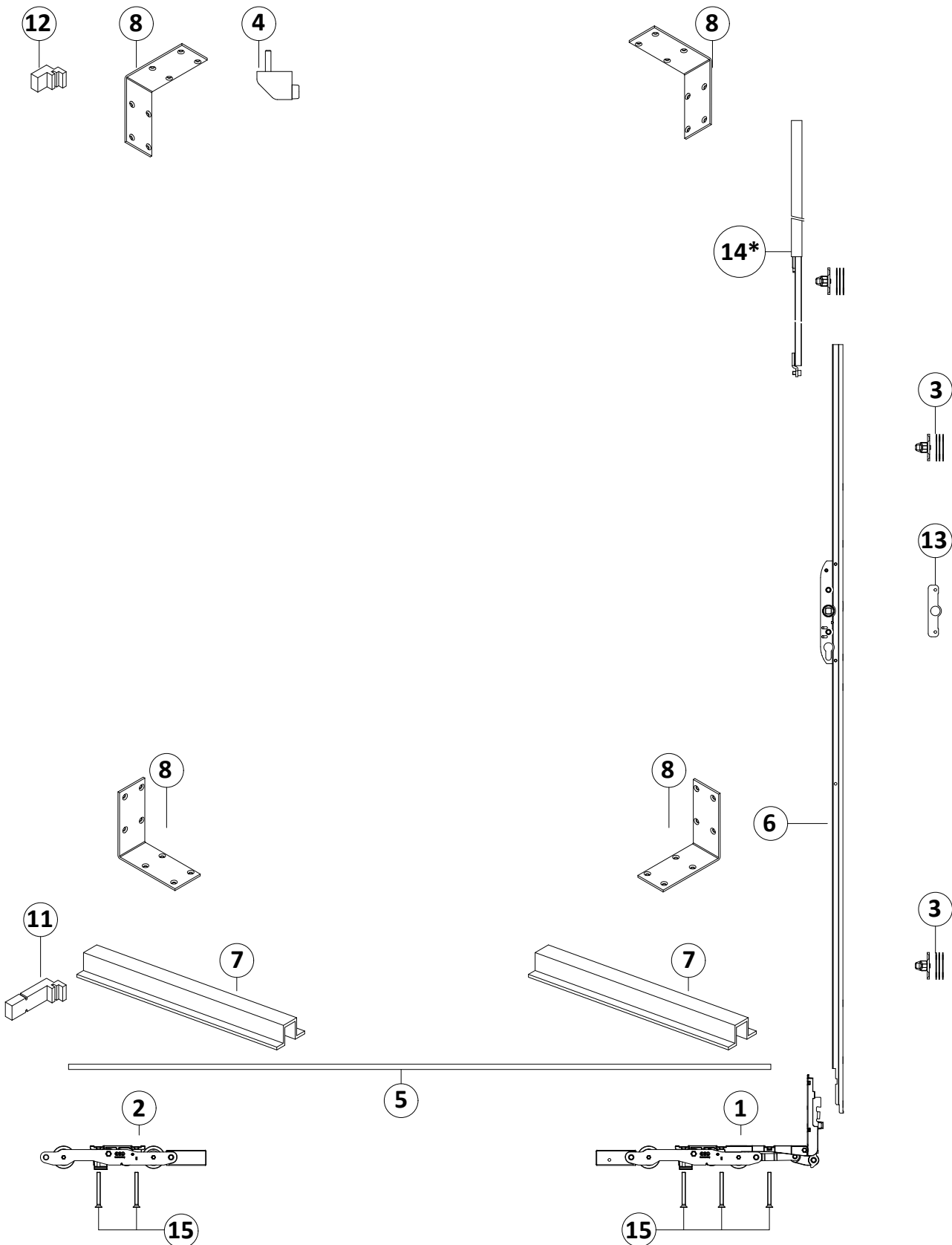
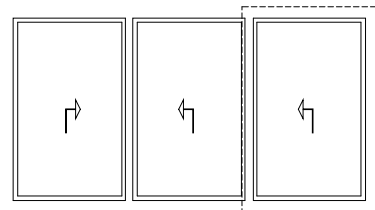

Schema | Type C3

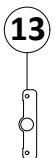
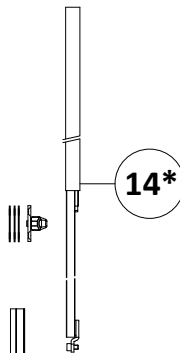
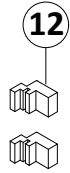
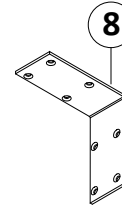
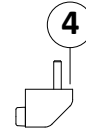
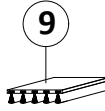
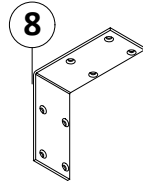
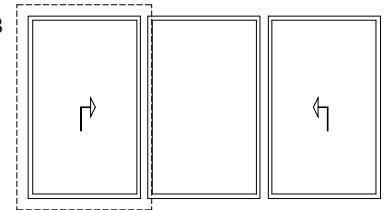

AG2996-7C3 - DESCRIZIONE   DESCRIPTION AG2996-7C3		
1	Carrello anteriore	Front carriage
2	Carrello posteriore	Rear carriage
3	Rostro di chiusura	Locking pin
4	Fermo anta	Bumper stop
5	Barra di unione	Stopper
6	Meccanismo	Mechanism
7	Profilo omega per fissaggio carrelli	Reinforcement profile for fixing carriage
8	Kit rinforzo angoli	Kit reinforcement
9	Tampone centrale di tenuta su guida sup.	Central sealing pad for upper rail
10	Tampone centrale di tenuta su guida inf.	Central sealing pad for bottom rail
11	Tampone di tenuta in neoprene	Neoprene sealing pads
12	Tampone di tenuta in neoprene	Neoprene sealing pads
13	Piastra per fissaggio maniglione singolo	Plate to attach single handle
14*	Prolunga meccanismo	Additional mechanism
15	Vite fissaggio carrelli (CV1140I/M)	Carriage fixing screw (CV1140I/M)

\* Presente solo su kit AG2996-7C3.E1  
Only on the kit AG2996-7C3.E1

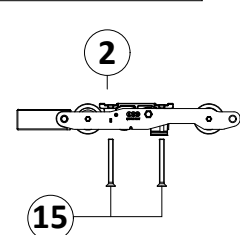
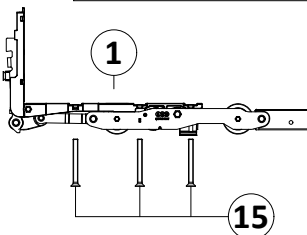
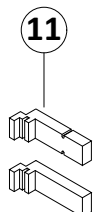
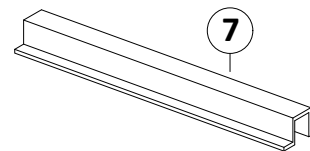
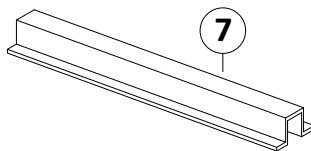
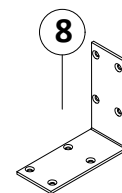
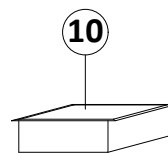
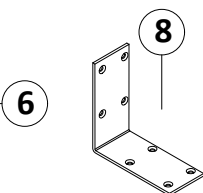
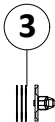

Schema | Type C3

kg  
250

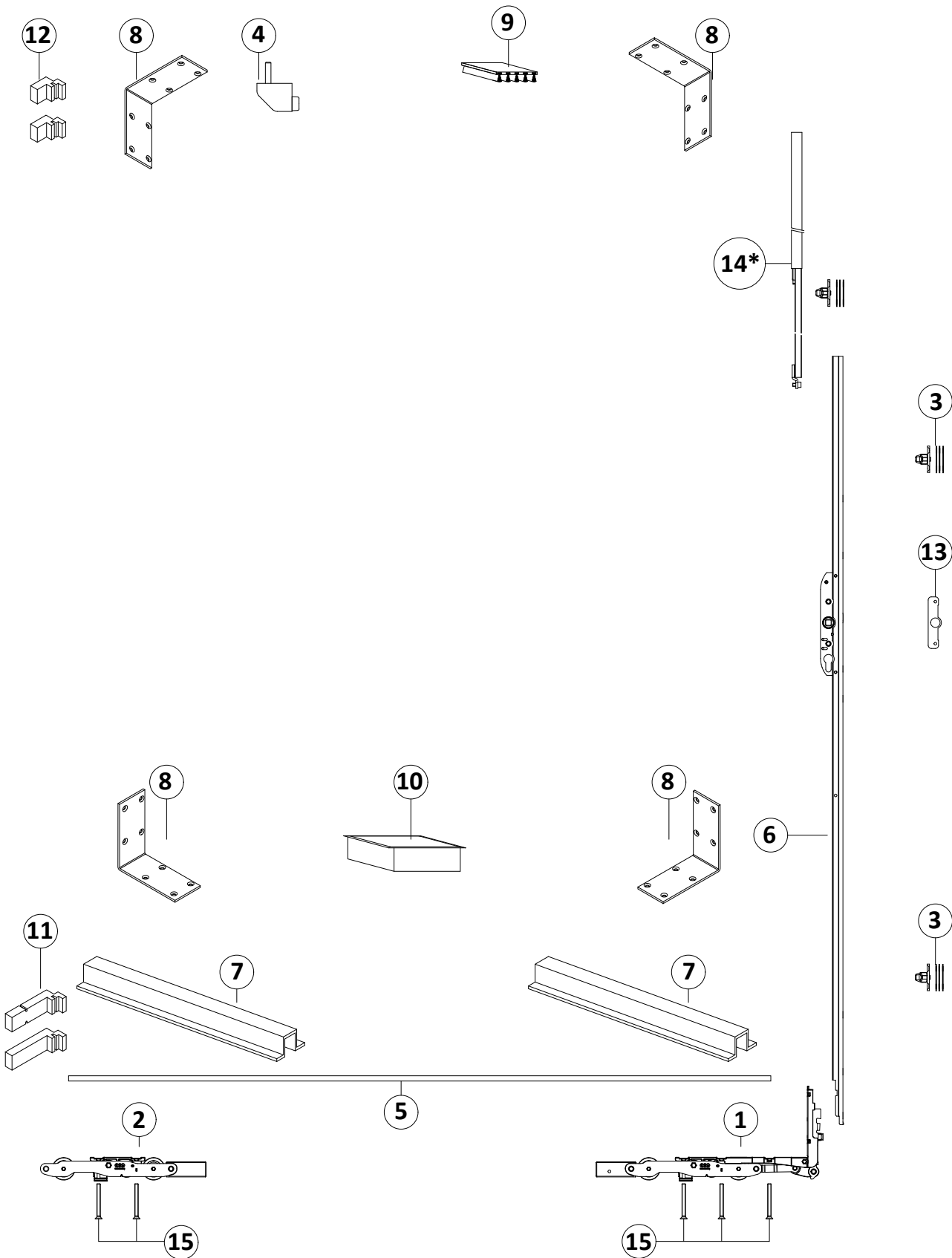
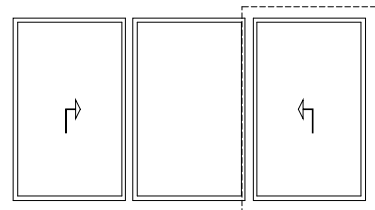

Schema | Type E3

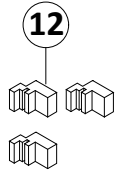
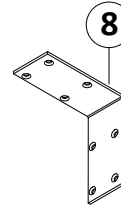
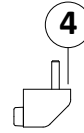
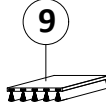
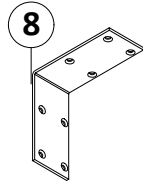
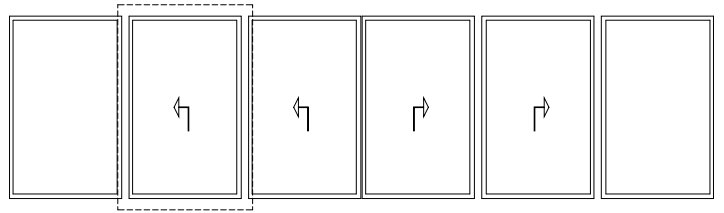

AG2996E3 - DESCRIZIONE   DESCRIPTION AG2996E3		
1	Carrello anteriore	Front carriage
2	Carrello posteriore	Rear carriage
3	Rostro di chiusura	Locking pin
4	Fermo anta	Bumper stop
5	Barra di unione	Stopper
6	Meccanismo	Mechanism
7	Profilo omega per fissaggio carrelli	Reinforcement profile for fixing carriage
8	Kit rinforzo angoli	Kit reinforcement
9	Tampone centrale di tenuta su guida sup.	Central sealing pad for upper rail
10	Tampone centrale di tenuta su guida inf.	Central sealing pad for bottom rail
11	Tampone di tenuta in neoprene	Neoprene sealing pads
12	Tampone di tenuta in neoprene	Neoprene sealing pads
13	Piastra per fissaggio maniglione singolo	Plate to attach single handle
14*	Prolunga meccanismo	Additional mechanism
15	Vite fissaggio carrelli (CV1140I/M)	Carriage fixing screw (CV1140I/M)

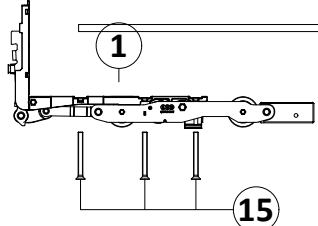
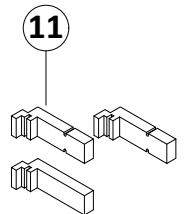
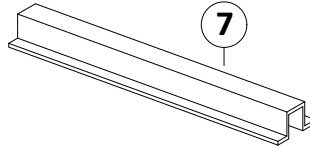
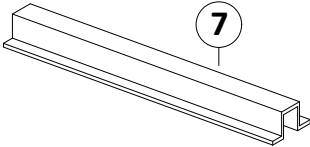
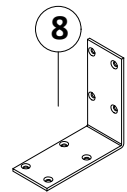
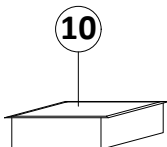
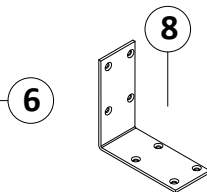
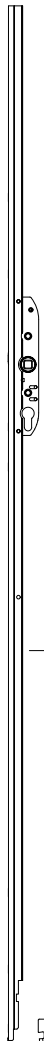
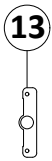

5

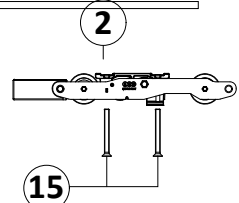

15

Schema | Type E3

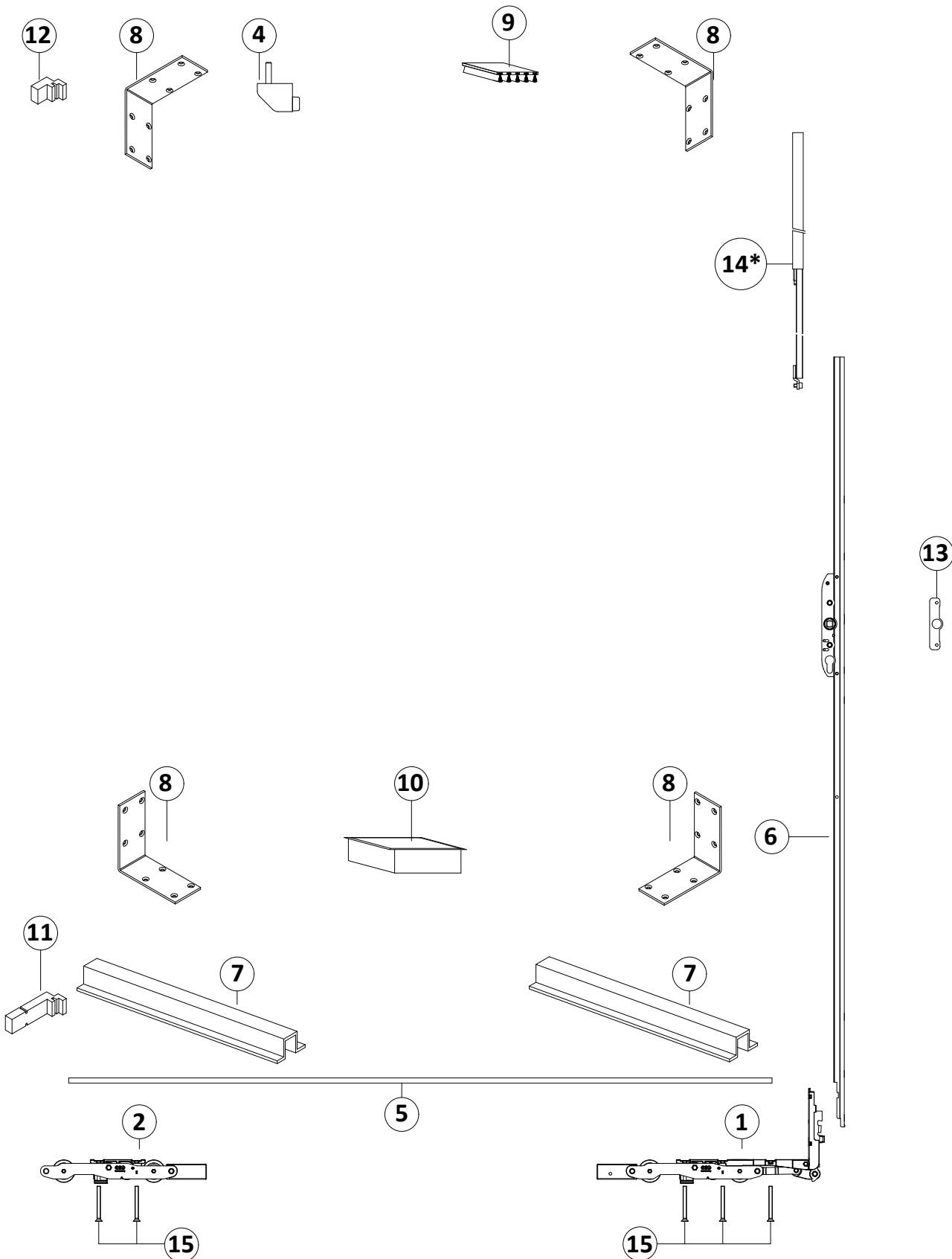
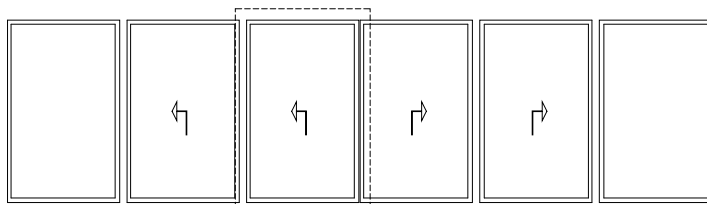

Schema | Type E3

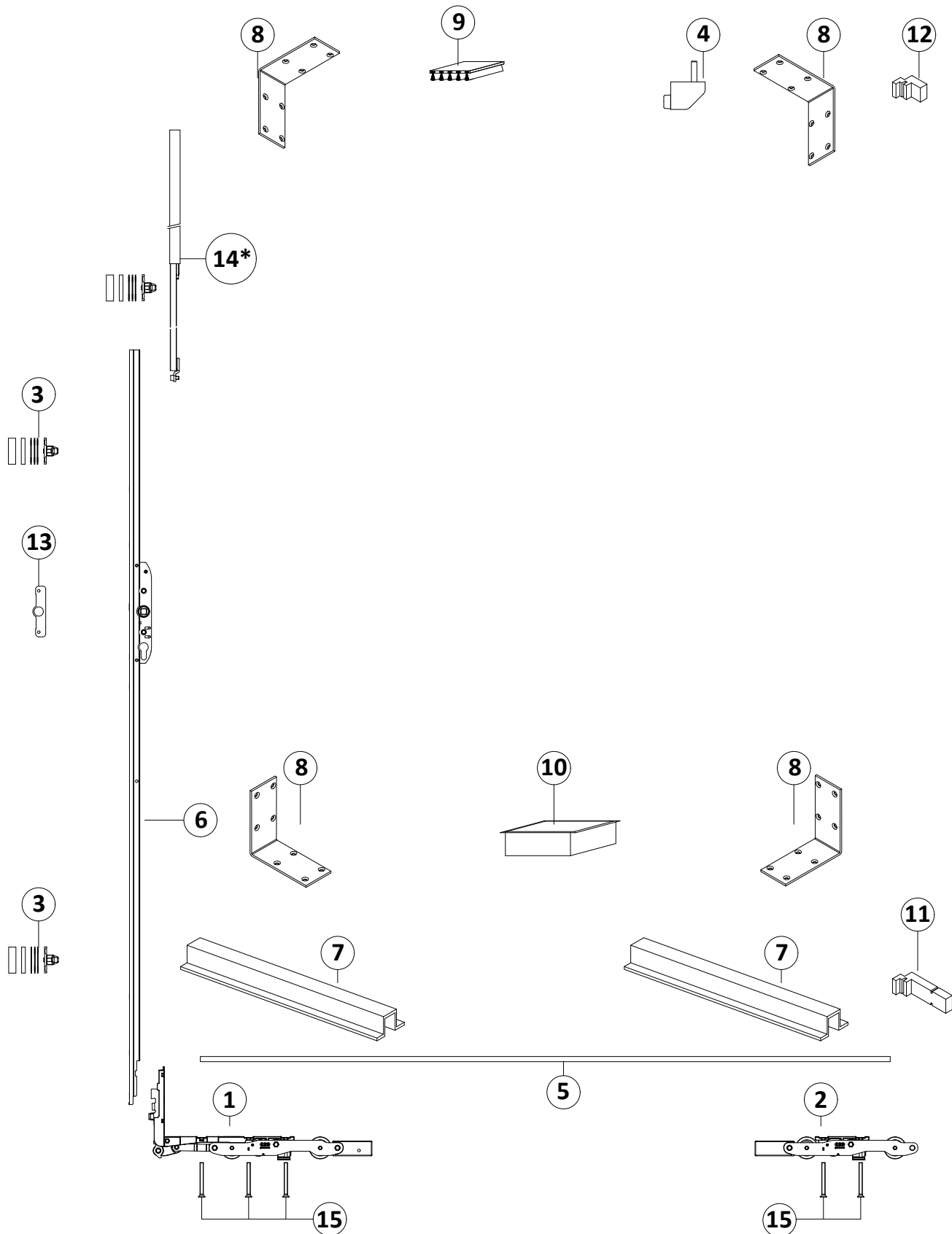
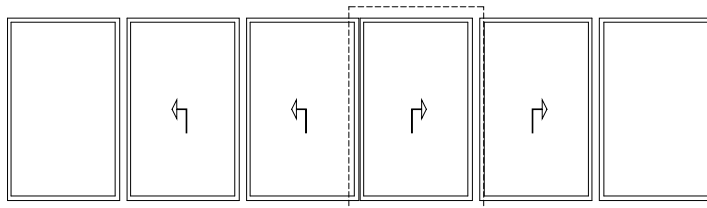

Schema | Type E3

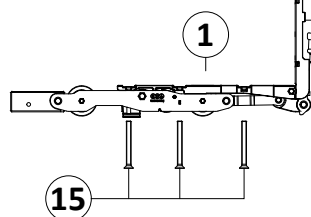
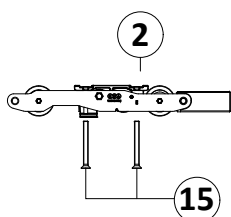
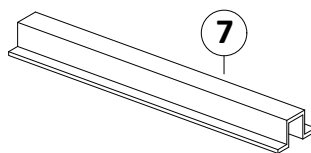
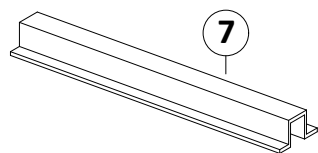
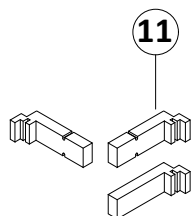
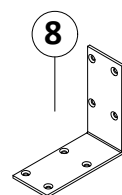
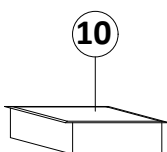
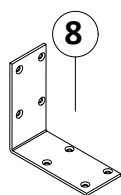
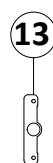
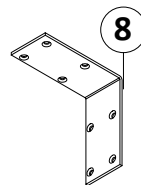
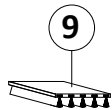
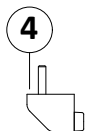
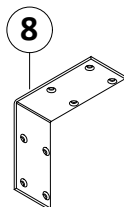
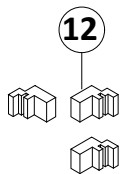
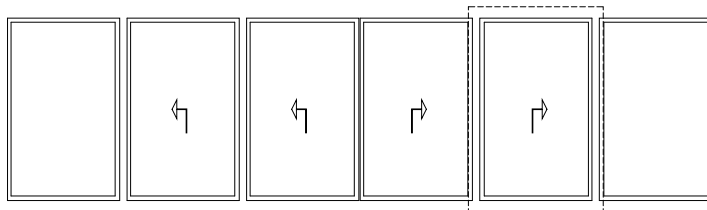

Schema | Type F3

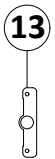
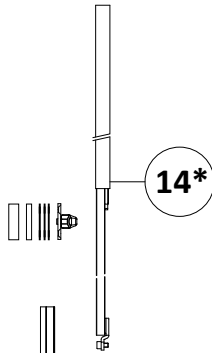
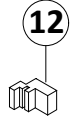
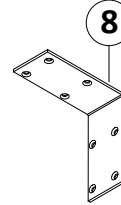
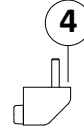
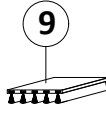
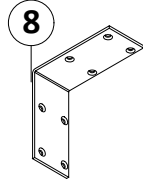
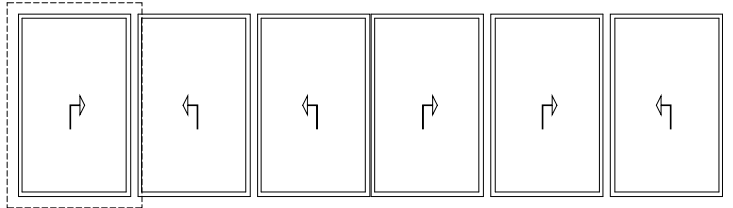

AG2996F3 - DESCRIZIONE   DESCRIPTION AG2996F3		
1	Carrello anteriore	Front carriage
2	Carrello posteriore	Rear carriage
3	Rostro di chiusura	Locking pin
4	Fermo anta	Bumper stop
5	Barra di unione	Stopper
6	Meccanismo	Mechanism
7	Profilo omega per fissaggio carrelli	Reinforcement profile for fixing carriage
8	Kit rinforzo angoli	Kit reinforcement
9	Tampone centrale di tenuta su guida sup.	Central sealing pad for upper rail
10	Tampone centrale di tenuta su guida inf.	Central sealing pad for bottom rail
11	Tampone di tenuta in neoprene	Neoprene sealing pads
12	Tampone di tenuta in neoprene	Neoprene sealing pads
13	Piastra per fissaggio maniglione singolo	Plate to attach single handle
14*	Prolunga meccanismo	Additional mechanism
15	Vite fissaggio carrelli (CV1140I/M)	Carriage fixing screw (CV1140I/M)

\* Presente solo su kit AG2996F3.E1  
Only on the kit AG2996F3.E1

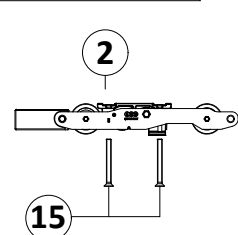
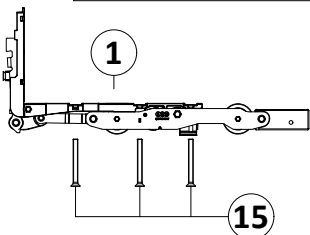
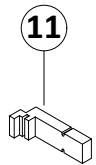
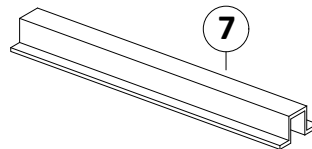
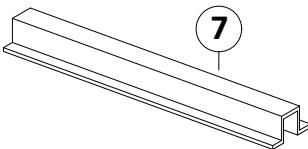
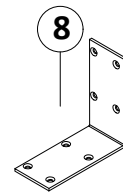
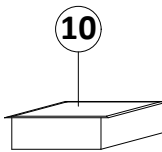
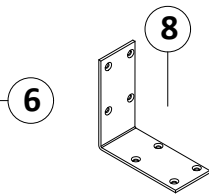



Schema | Type F3

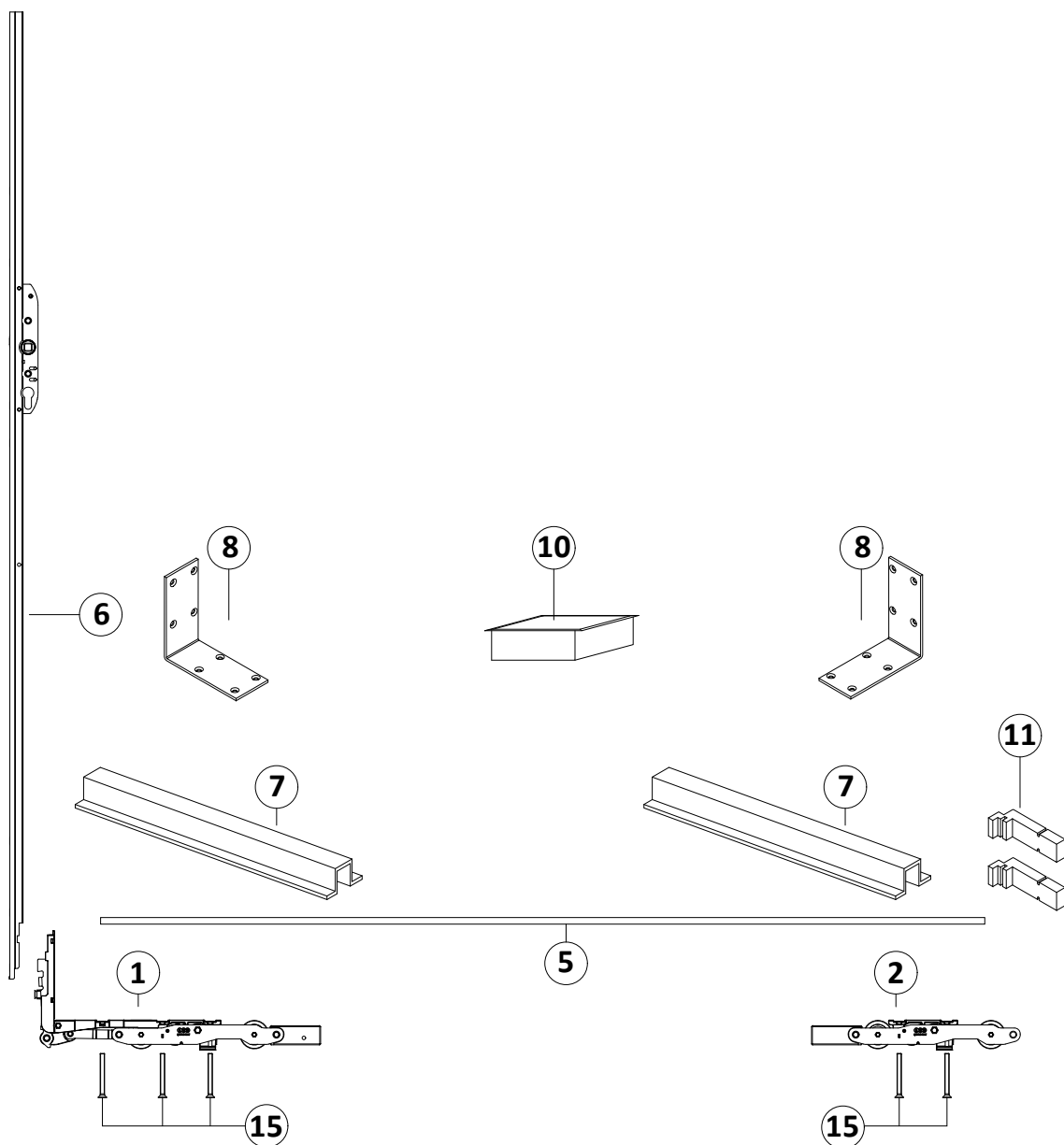
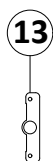
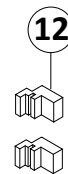
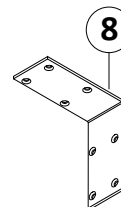
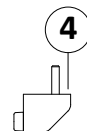
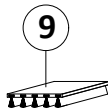
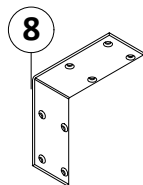
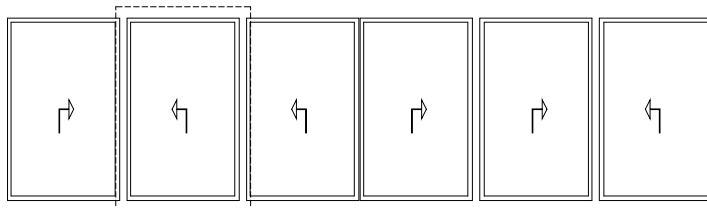

Schema | Type F3

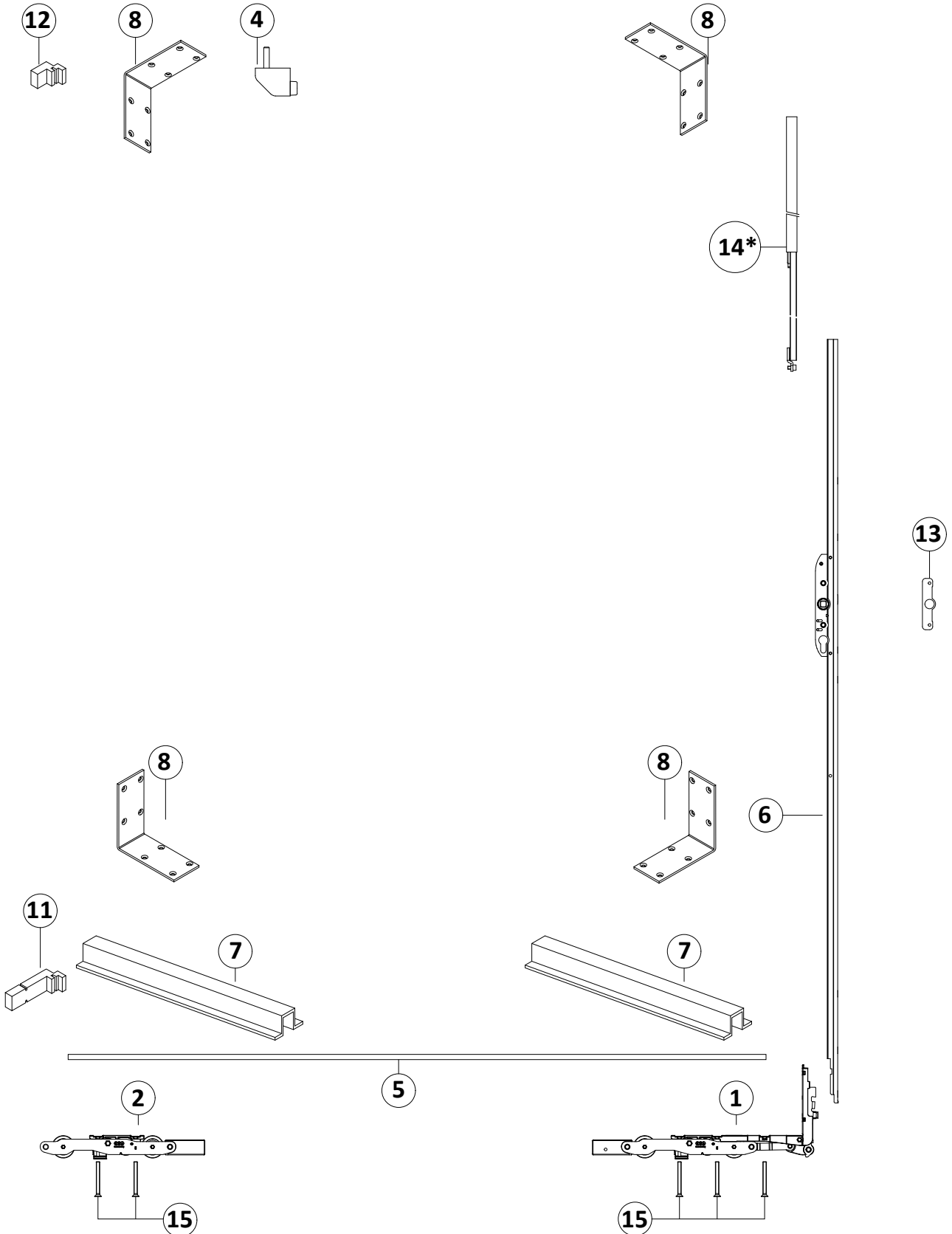
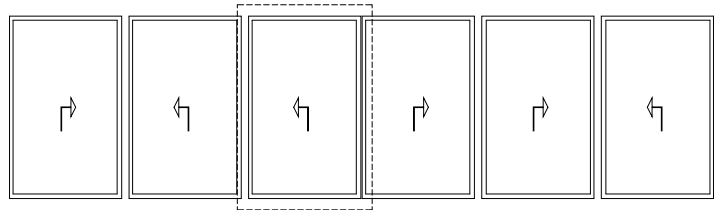

Schema | Type F3

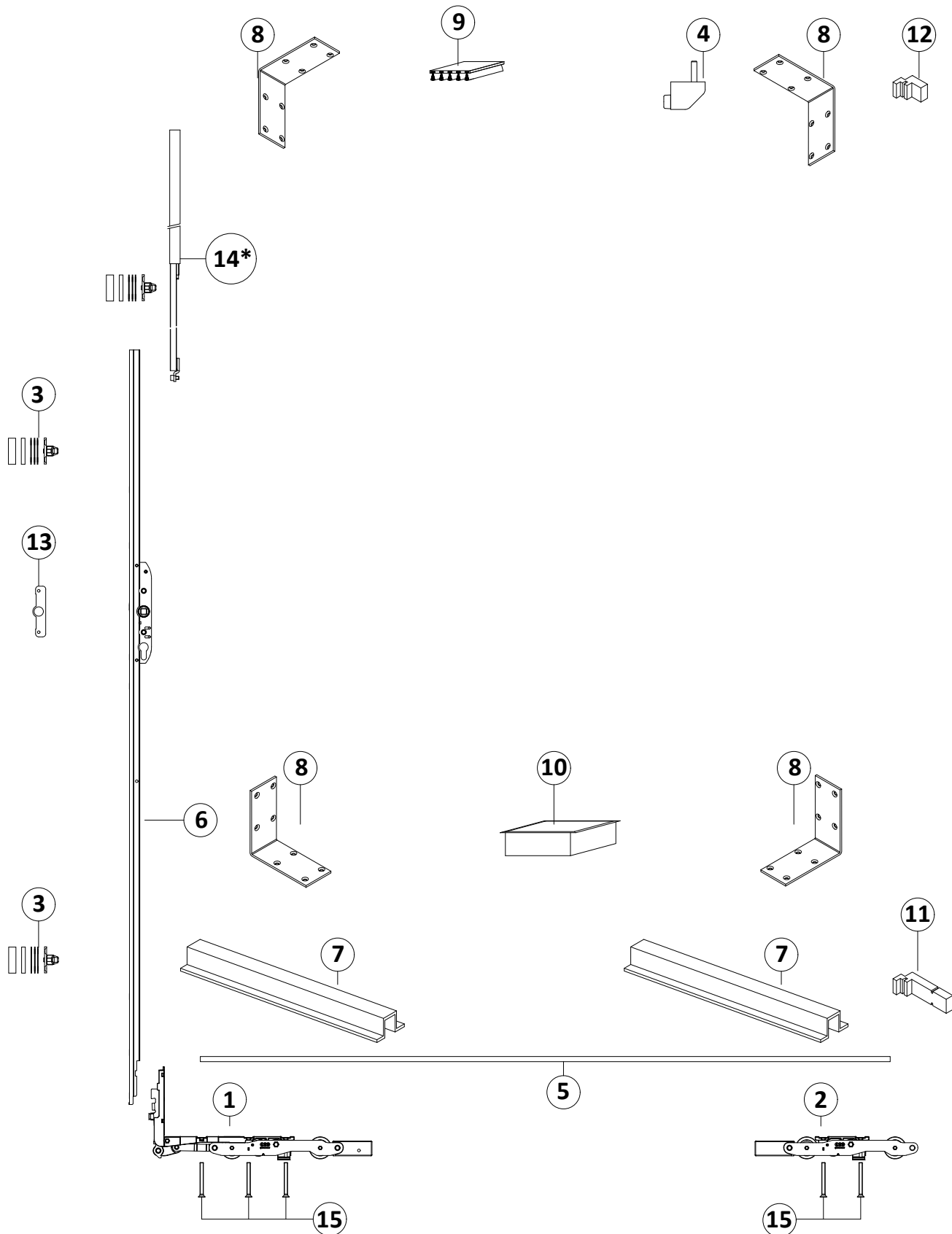
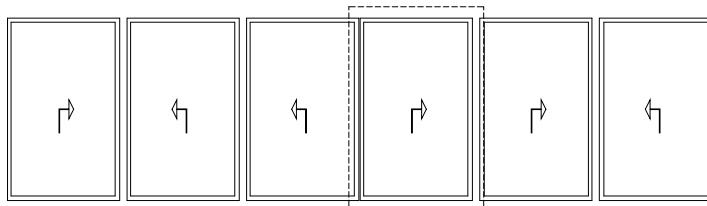

Schema | Type F3

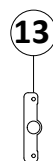
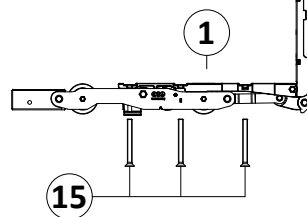
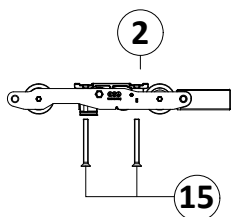
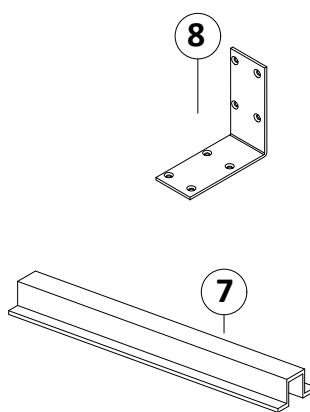
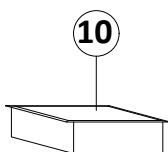
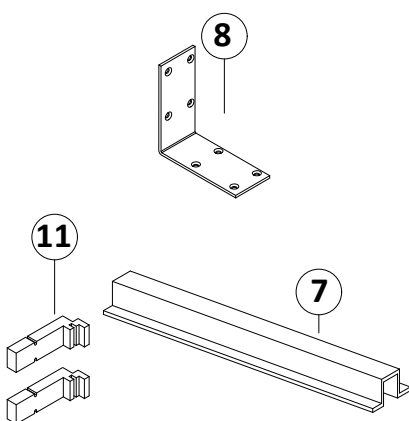
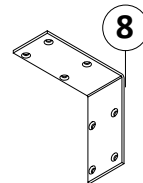
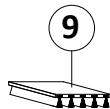
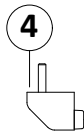
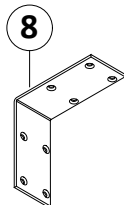
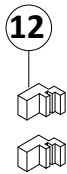
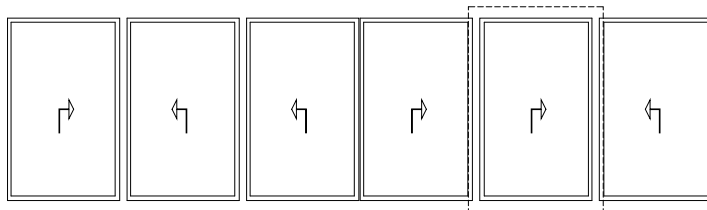

Schema | Type F3

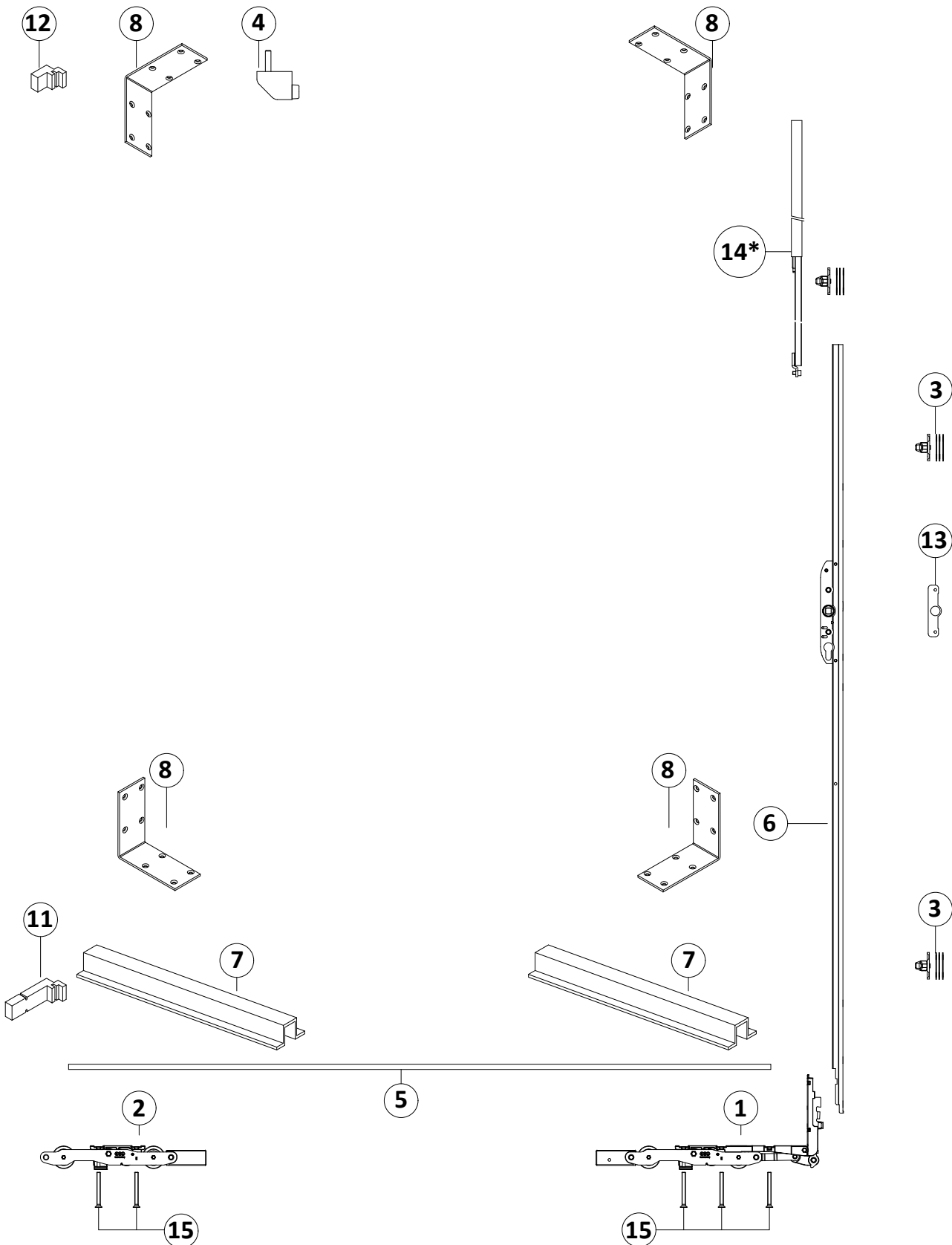
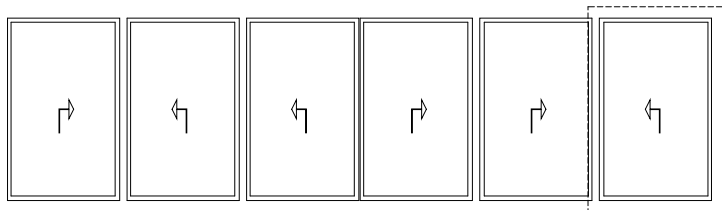

Schema | Type S2

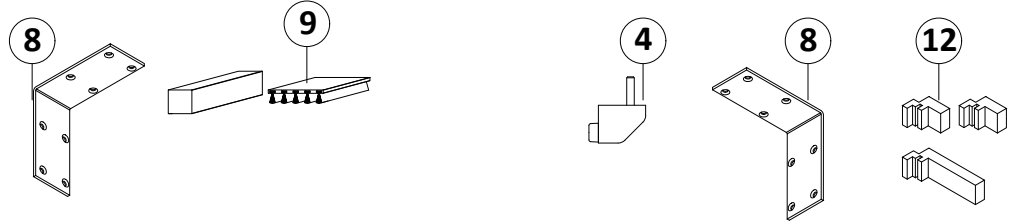
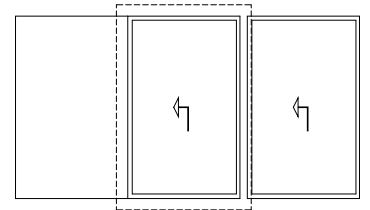

AG2996S2 - DESCRIZIONE   DESCRIPTION AG2996S2		
1	Carrello anteriore	Front carriage
2	Carrello posteriore	Rear carriage
3	Rostro di chiusura	Locking pin
4	Fermo anta	Bumper stop
5	Barra di unione	Stopper
6	Meccanismo	Mechanism
7	Profilo omega per fissaggio carrelli	Reinforcement profile for fixing carriage
8	Kit rinforzo angoli	Kit reinforcement
9	Tampone centrale di tenuta su guida sup.	Central sealing pad for upper rail
10	Tampone centrale di tenuta su guida inf.	Central sealing pad for bottom rail
11	Tampone di tenuta in neoprene	Neoprene sealing pads
12	Tampone di tenuta in neoprene	Neoprene sealing pads
13	Piastra per fissaggio maniglione singolo	Plate to attach single handle
14*	Prolunga meccanismo	Additional mechanism
15	Vite fissaggio carrelli (CV1140I/M)	Carriage fixing screw (CV1140I/M)

\* Presente solo su kit AG2996-7S2.E1  
Only on the kit AG2996-7S2.E1

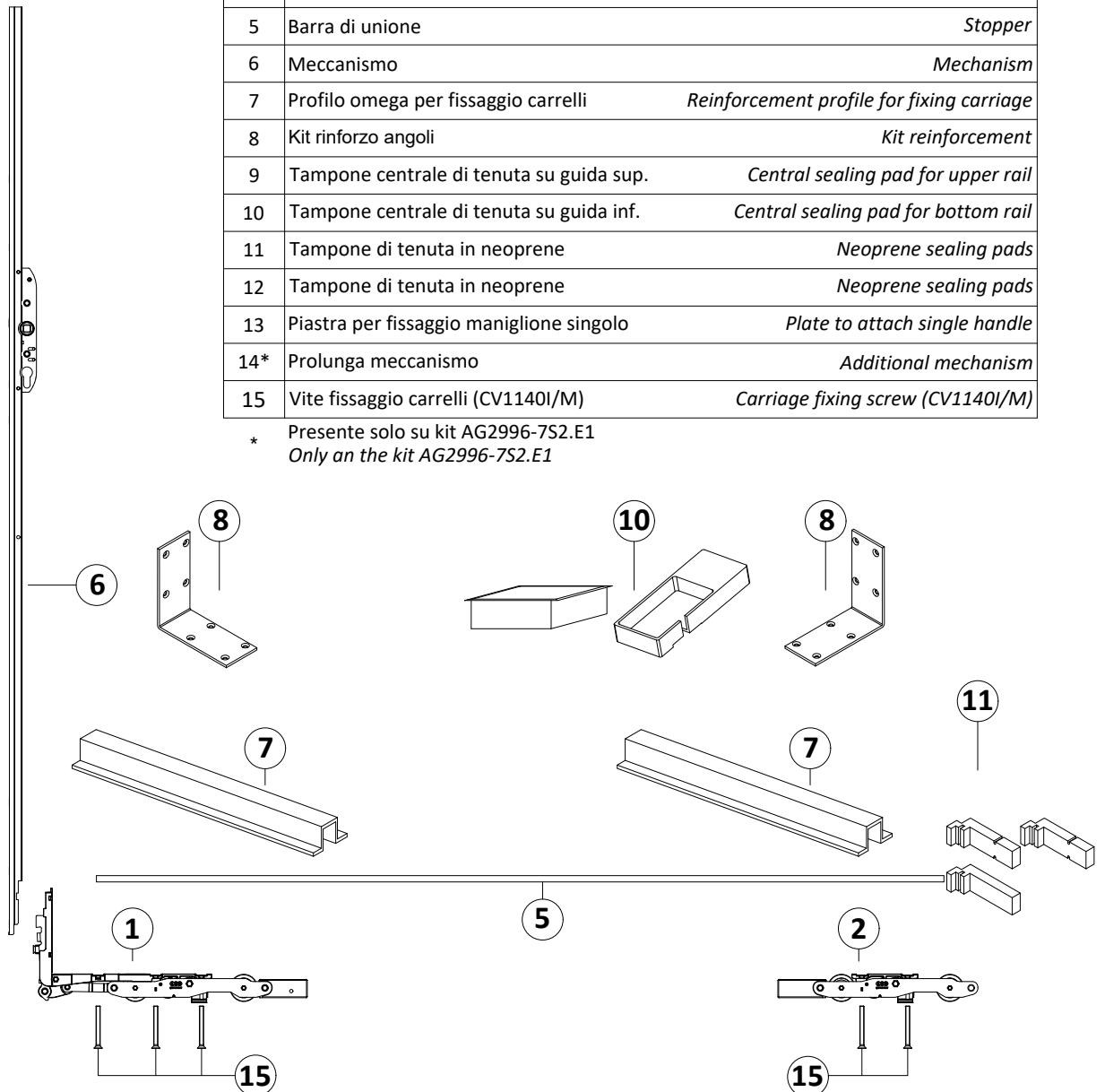
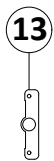

Schema | Type S2

kg  
250

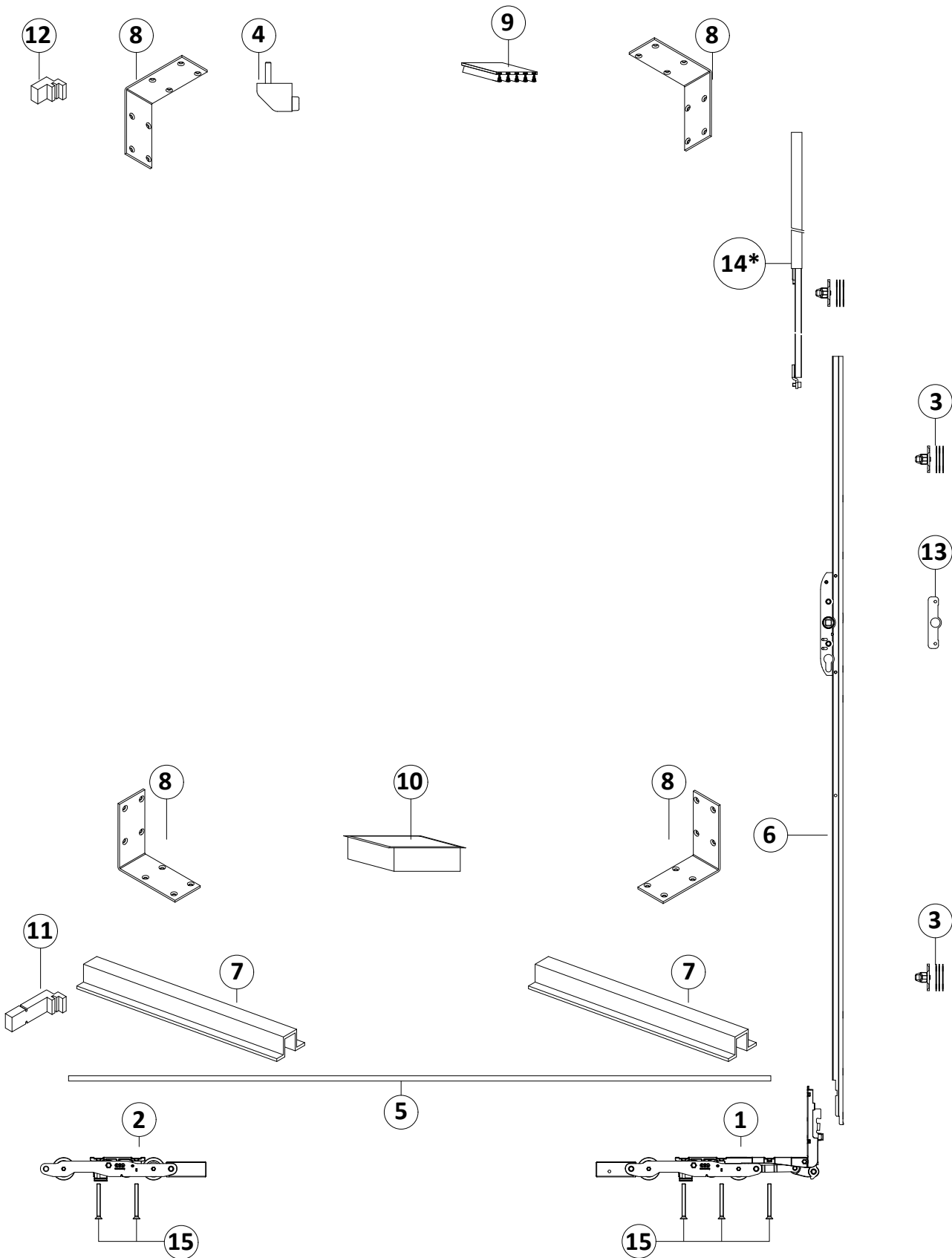
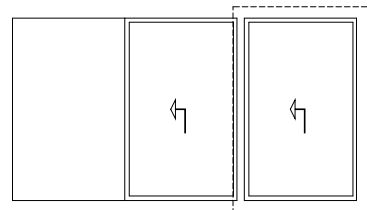

Schema | Type T2

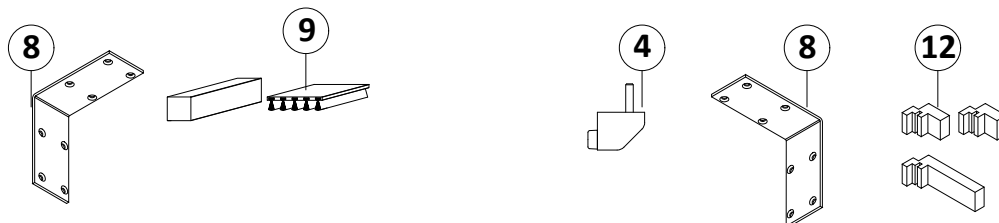
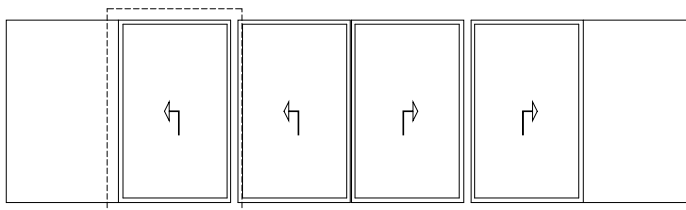

	AG2996T2- DESCRIZIONE   DESCRIPTION AG2996T2	
1	Carrello anteriore	Front carriage
2	Carrello posteriore	Rear carriage
3	Rostro di chiusura	Locking pin
4	Fermo anta	Bumper stop
5	Barra di unione	Stopper
6	Meccanismo	Mechanism
7	Profilo omega per fissaggio carrelli	Reinforcement profile for fixing carriage
8	Kit rinforzo angoli	Kit reinforcement
9	Tampone centrale di tenuta su guida sup.	Central sealing pad for upper rail
10	Tampone centrale di tenuta su guida inf.	Central sealing pad for bottom rail
11	Tampone di tenuta in neoprene	Neoprene sealing pads
12	Tampone di tenuta in neoprene	Neoprene sealing pads
13	Piastra per fissaggio maniglione singolo	Plate to attach single handle
14*	Prolunga meccanismo	Additional mechanism
15	Vite fissaggio carrelli (CV1140I/M)	Carriage fixing screw (CV1140I/M)

\* Presente solo su kit AG2996-7T2.E1  
Only on the kit AG2996-7T2.E1

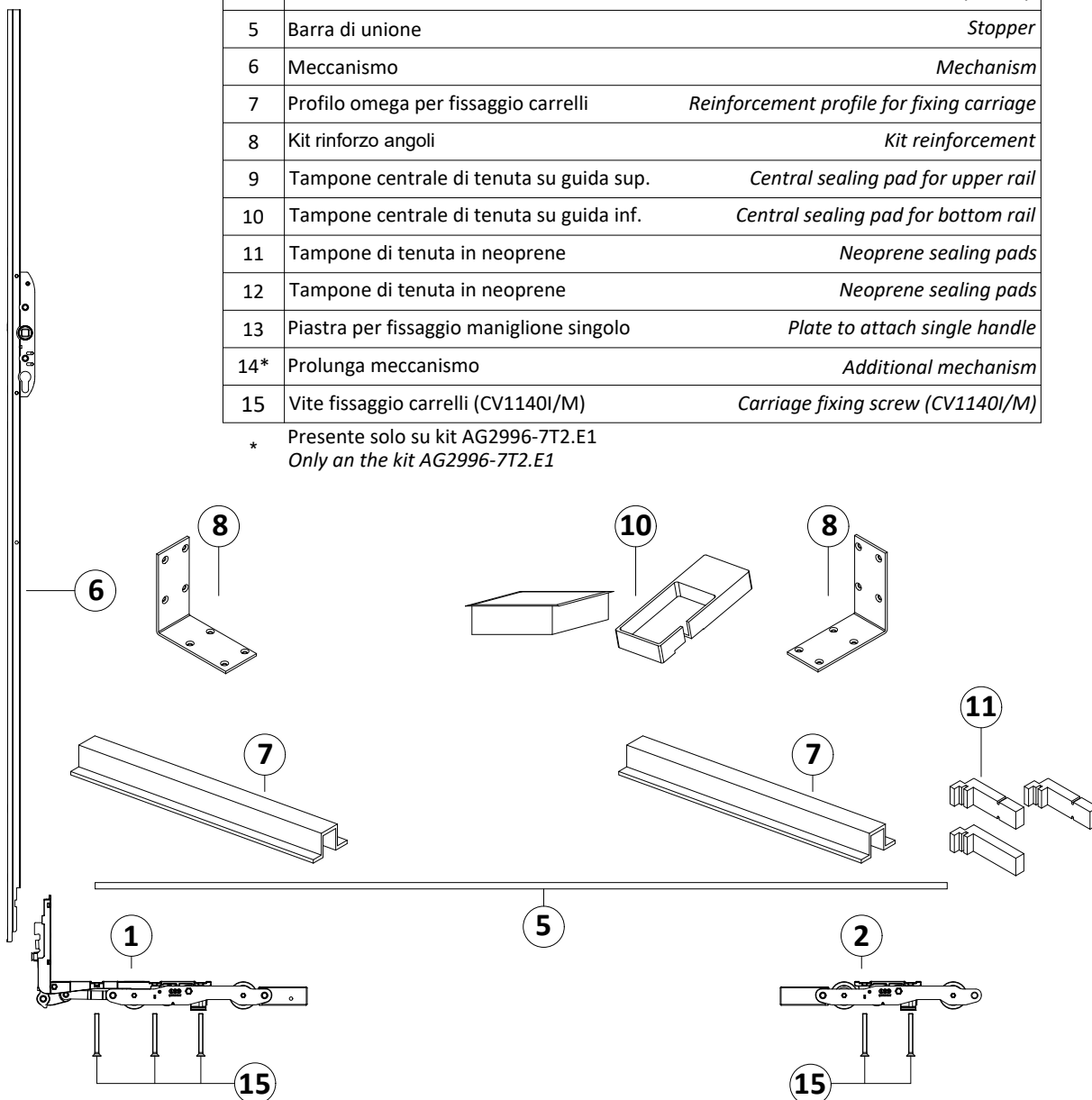
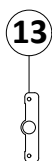



Schema | Type T2

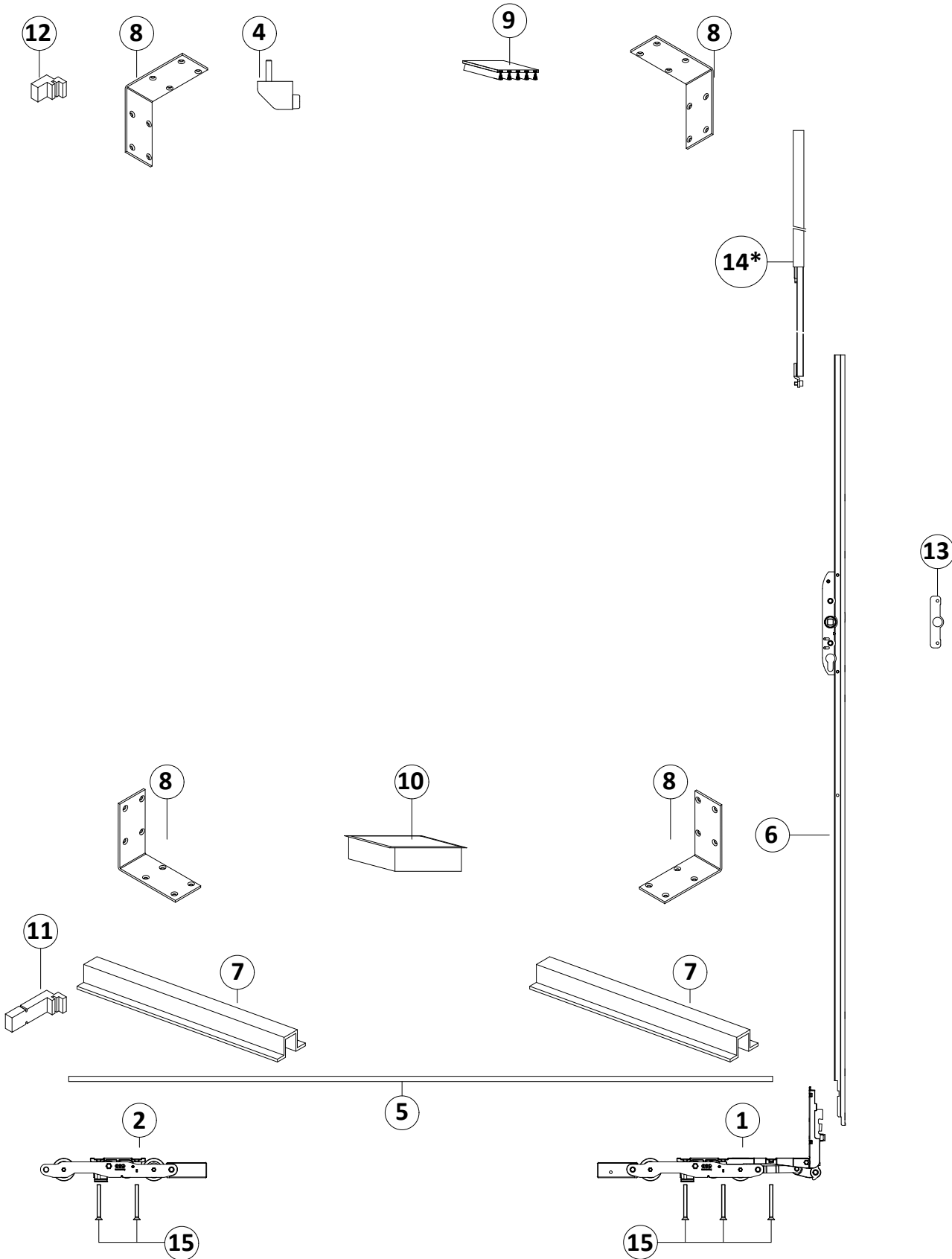
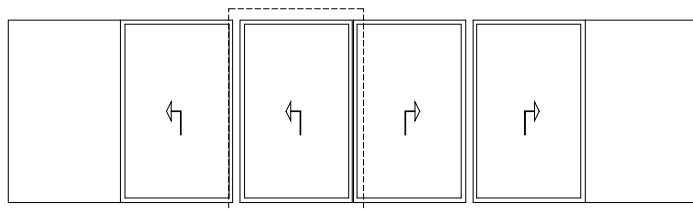

Schema | Type T2

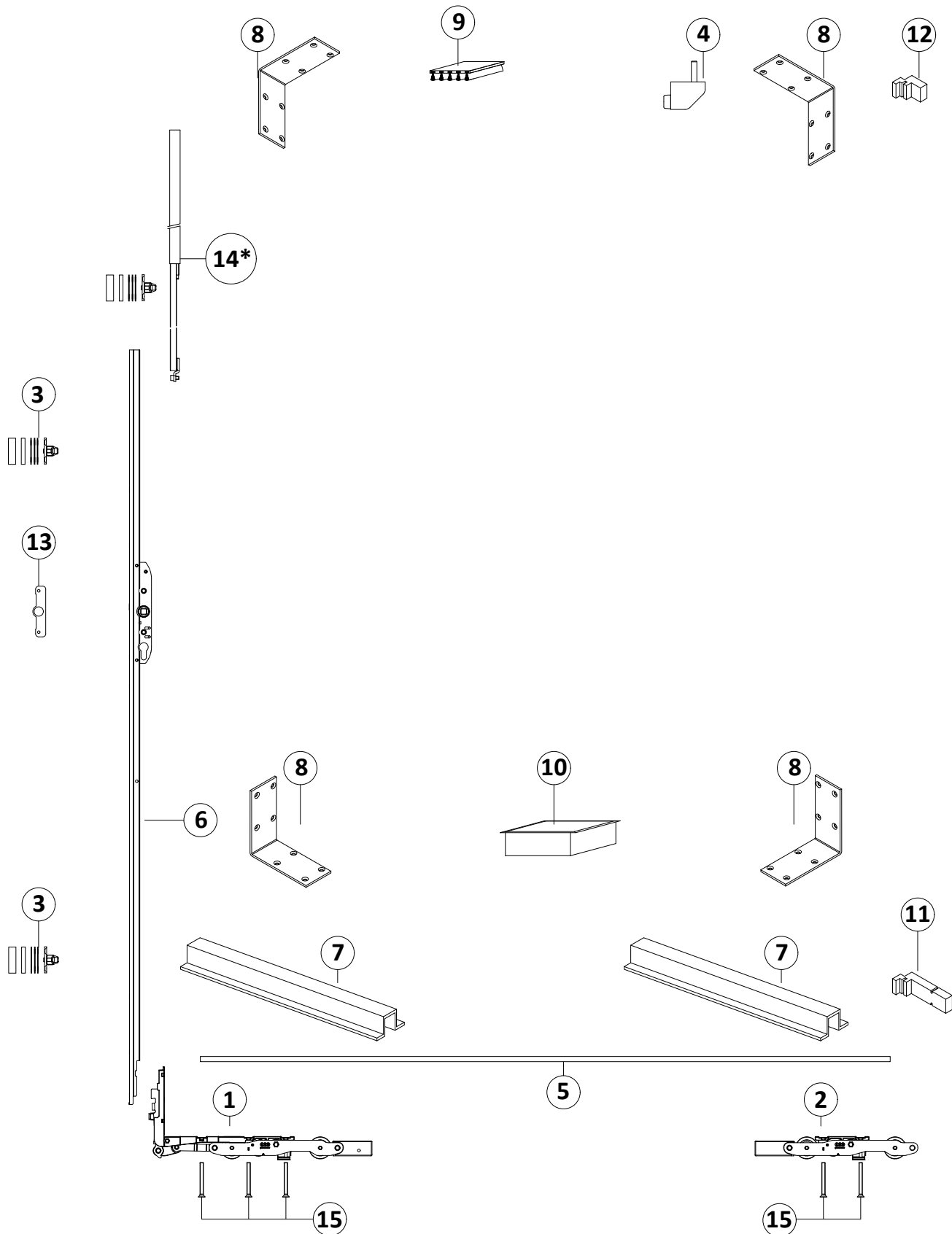
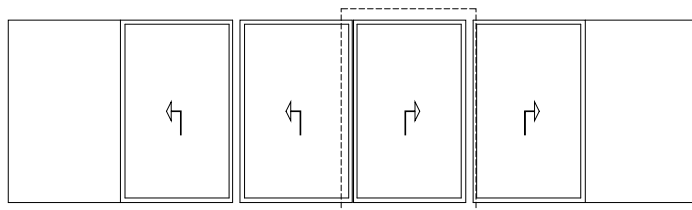

Schema | Type T2

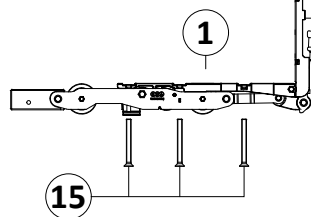
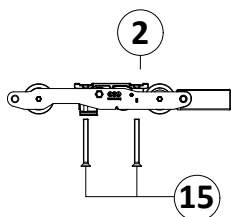
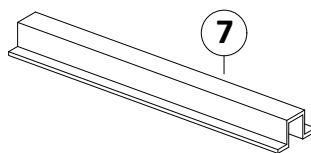
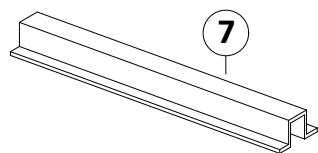
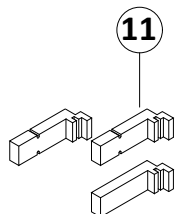
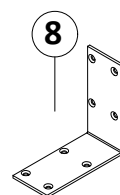
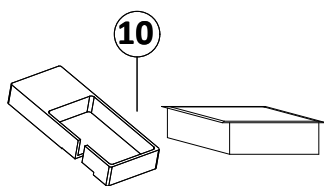
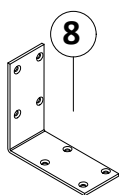
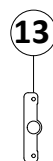
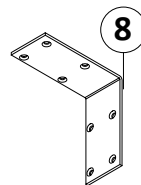
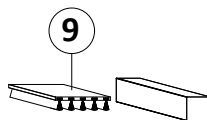
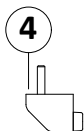
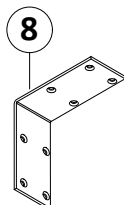
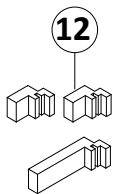
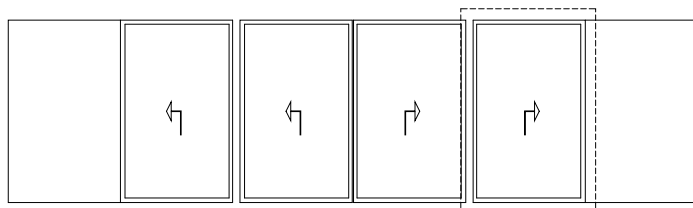

Schema | Type S3

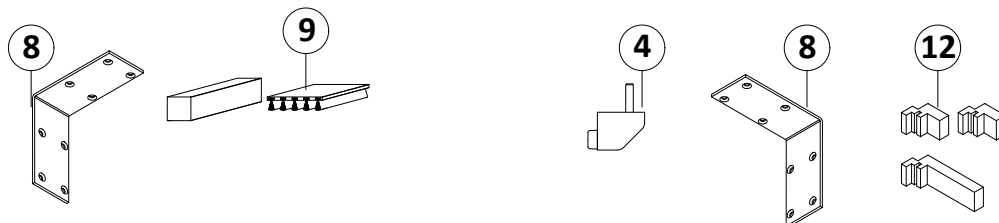
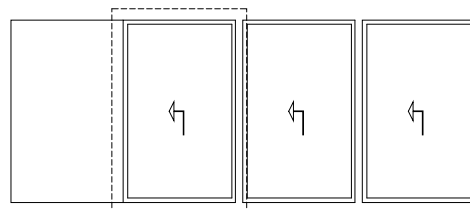

AG2996-7S3 - DESCRIZIONE   DESCRIPTION AG2996-7S3		
1	Carrello anteriore	Front carriage
2	Carrello posteriore	Rear carriage
3	Rostro di chiusura	Locking pin
4	Fermo anta	Bumper stop
5	Barra di unione	Stopper
6	Meccanismo	Mechanism
7	Profilo omega per fissaggio carrelli	Reinforcement profile for fixing carriage
8	Kit rinforzo angoli	Kit reinforcement
9	Tampone centrale di tenuta su guida sup.	Central sealing pad for upper rail
10	Tampone centrale di tenuta su guida inf.	Central sealing pad for bottom rail
11	Tampone di tenuta in neoprene	Neoprene sealing pads
12	Tampone di tenuta in neoprene	Neoprene sealing pads
13	Piastra per fissaggio maniglione singolo	Plate to attach single handle
14*	Prolunga meccanismo	Additional mechanism
15	Vite fissaggio carrelli (CV1140I/M)	Carriage fixing screw (CV1140I/M)

\* Presente solo su kit AG2996-7S3.E1  
Only on the kit AG2996-7S3.E1

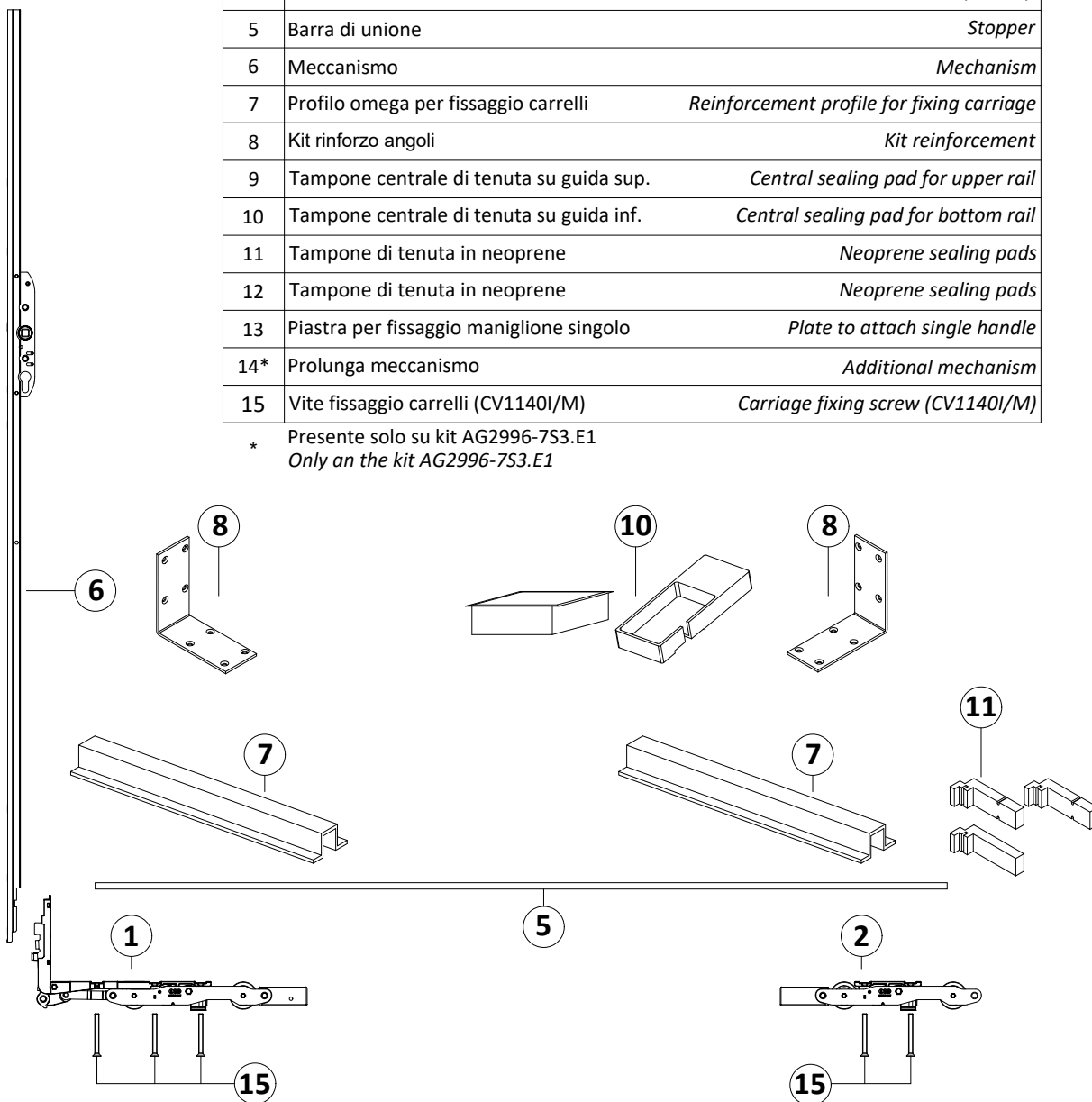
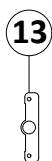

Schema | Type S3

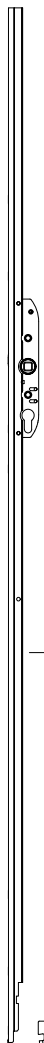
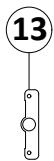
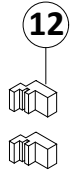
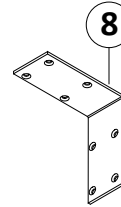
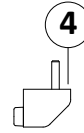
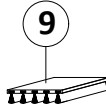
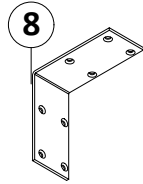
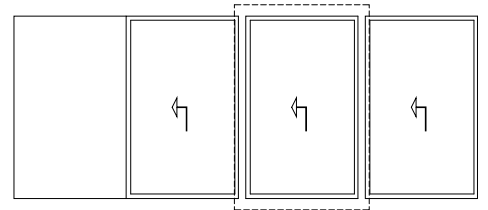

6

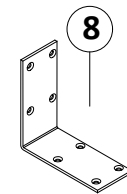

10

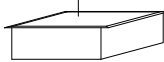

7

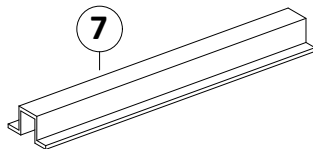

7

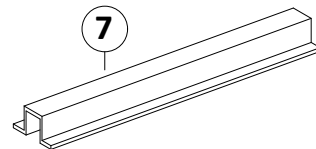

11

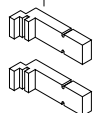

1

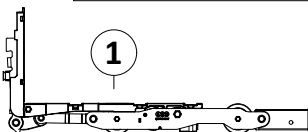

5



2

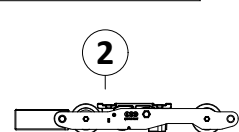

15

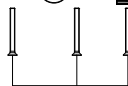

15



Schema | Type S3

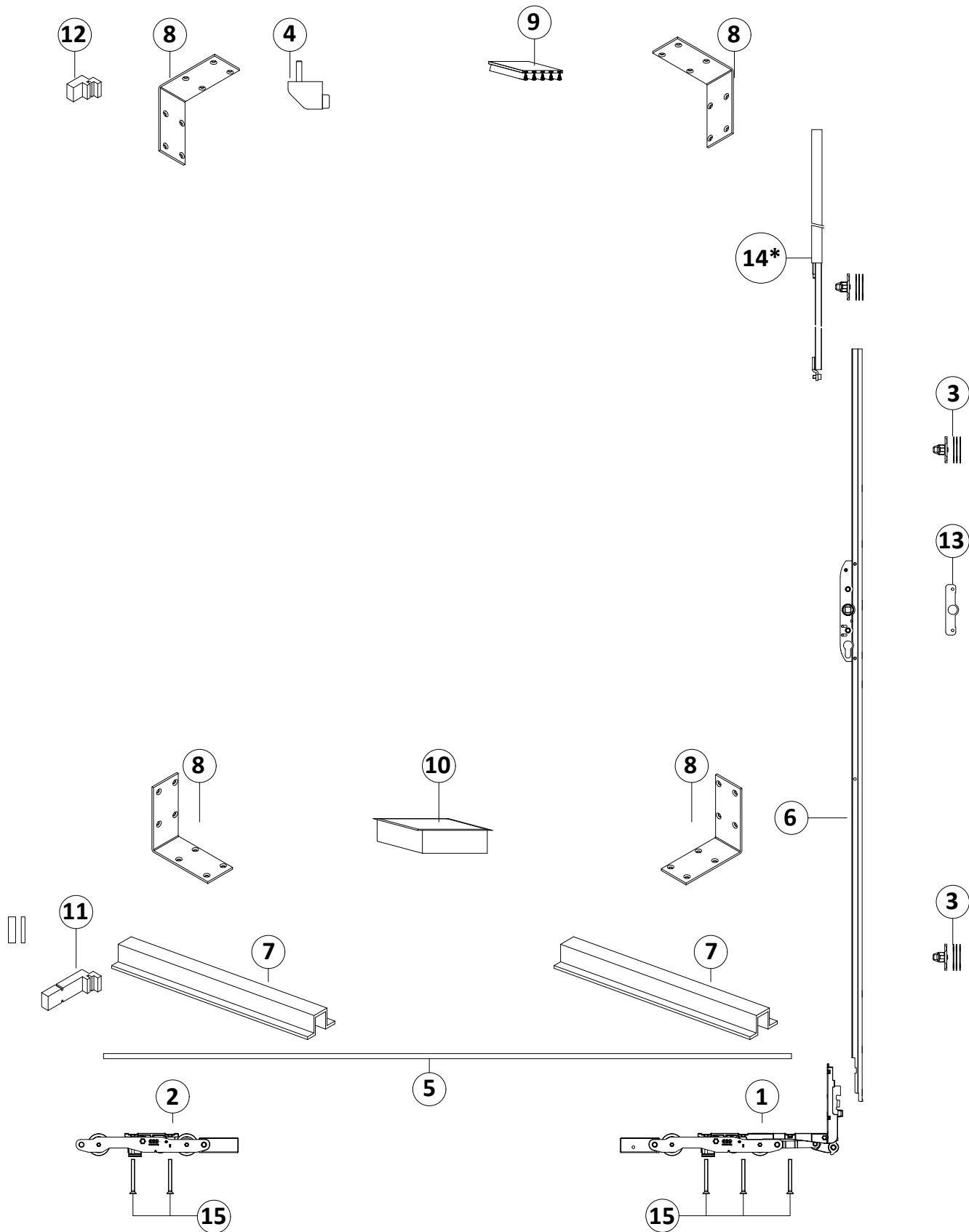
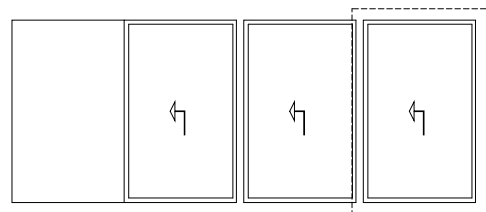

Schema | Type T3

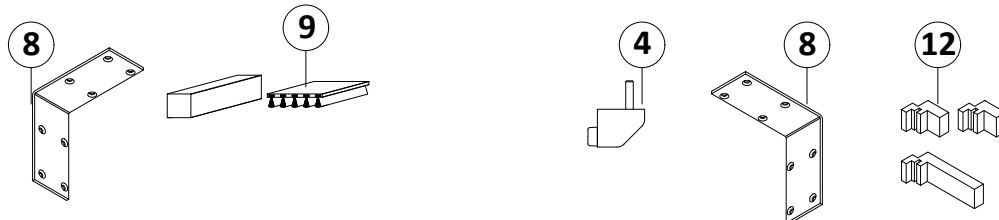
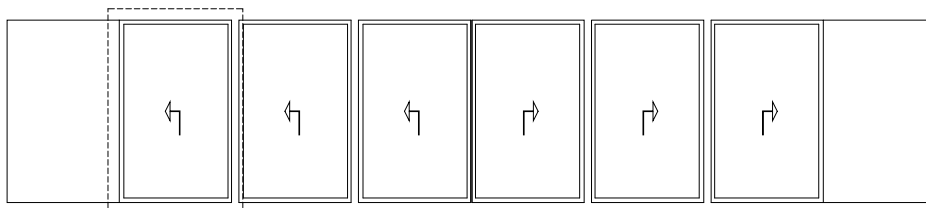

AG2996T3 - DESCRIZIONE   DESCRIPTION AG2996T3		
1	Carrello anteriore	Front carriage
2	Carrello posteriore	Rear carriage
3	Rostro di chiusura	Locking pin
4	Fermo anta	Bumper stop
5	Barra di unione	Stopper
6	Meccanismo	Mechanism
7	Profilo omega per fissaggio carrelli	Reinforcement profile for fixing carriage
8	Kit rinforzo angoli	Kit reinforcement
9	Tampone centrale di tenuta su guida sup.	Central sealing pad for upper rail
10	Tampone centrale di tenuta su guida inf.	Central sealing pad for bottom rail
11	Tampone di tenuta in neoprene	Neoprene sealing pads
12	Tampone di tenuta in neoprene	Neoprene sealing pads
13	Piastra per fissaggio maniglione singolo	Plate to attach single handle
14*	Prolunga meccanismo	Additional mechanism
15	Vite fissaggio carrelli (CV1140I/M)	Carriage fixing screw (CV1140I/M)

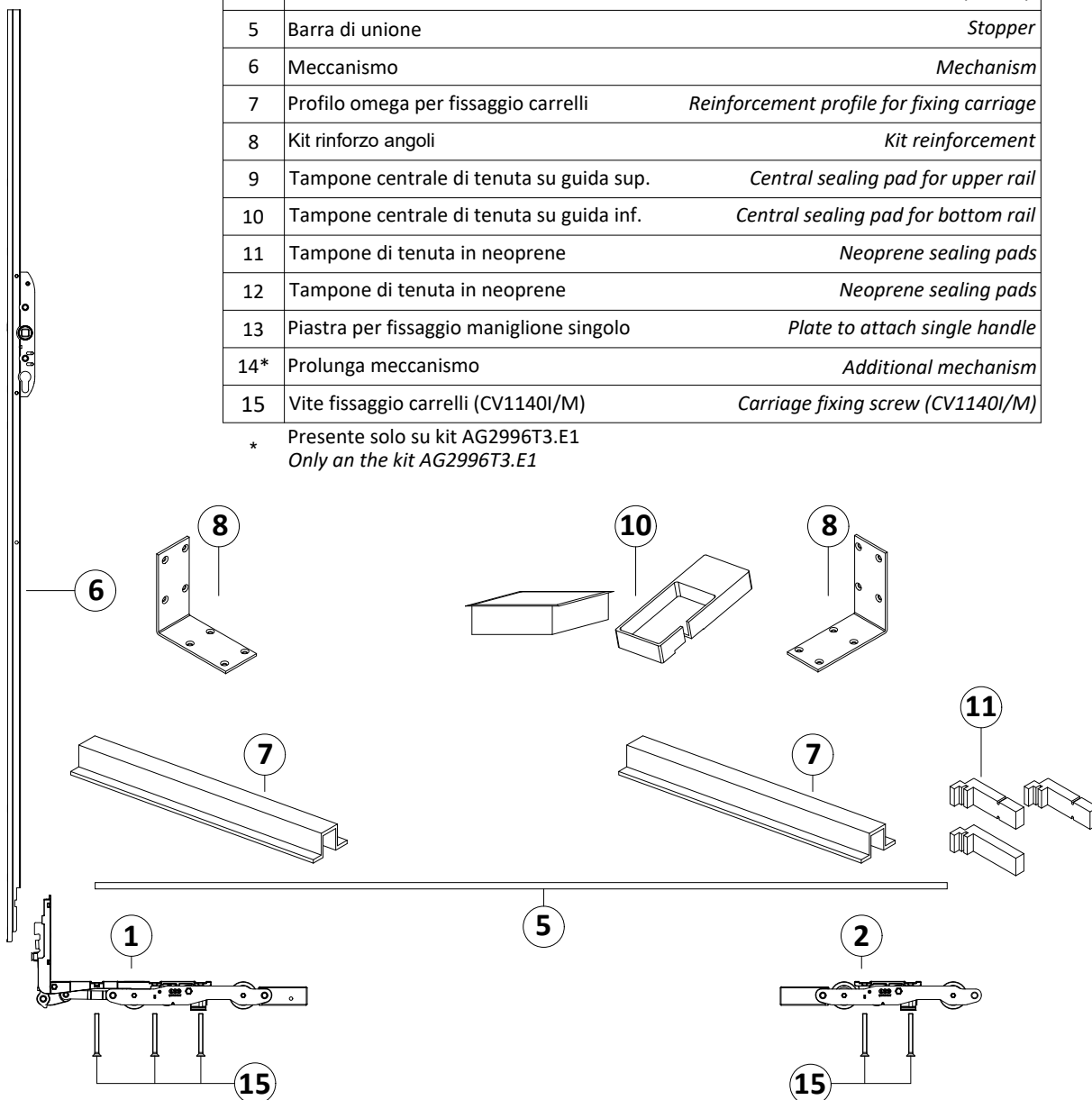
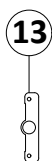

\* Presente solo su kit AG2996T3.E1  
Only on the kit AG2996T3.E1

Schema | Type T3

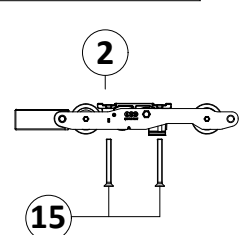
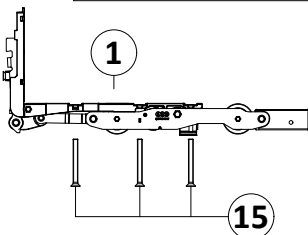
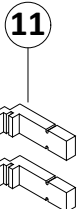
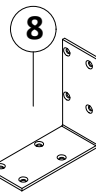
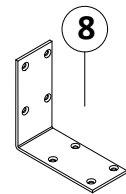
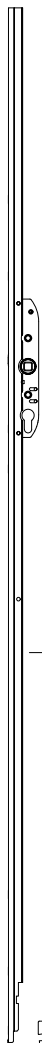
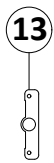
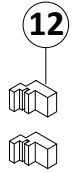
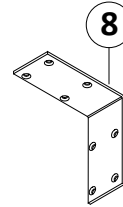
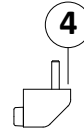
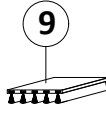
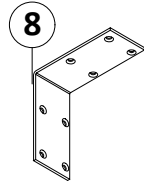
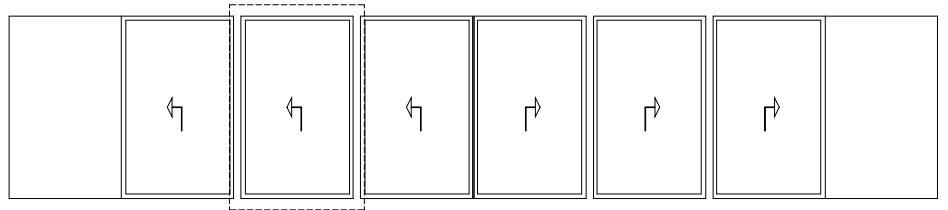



Schema | Type T3

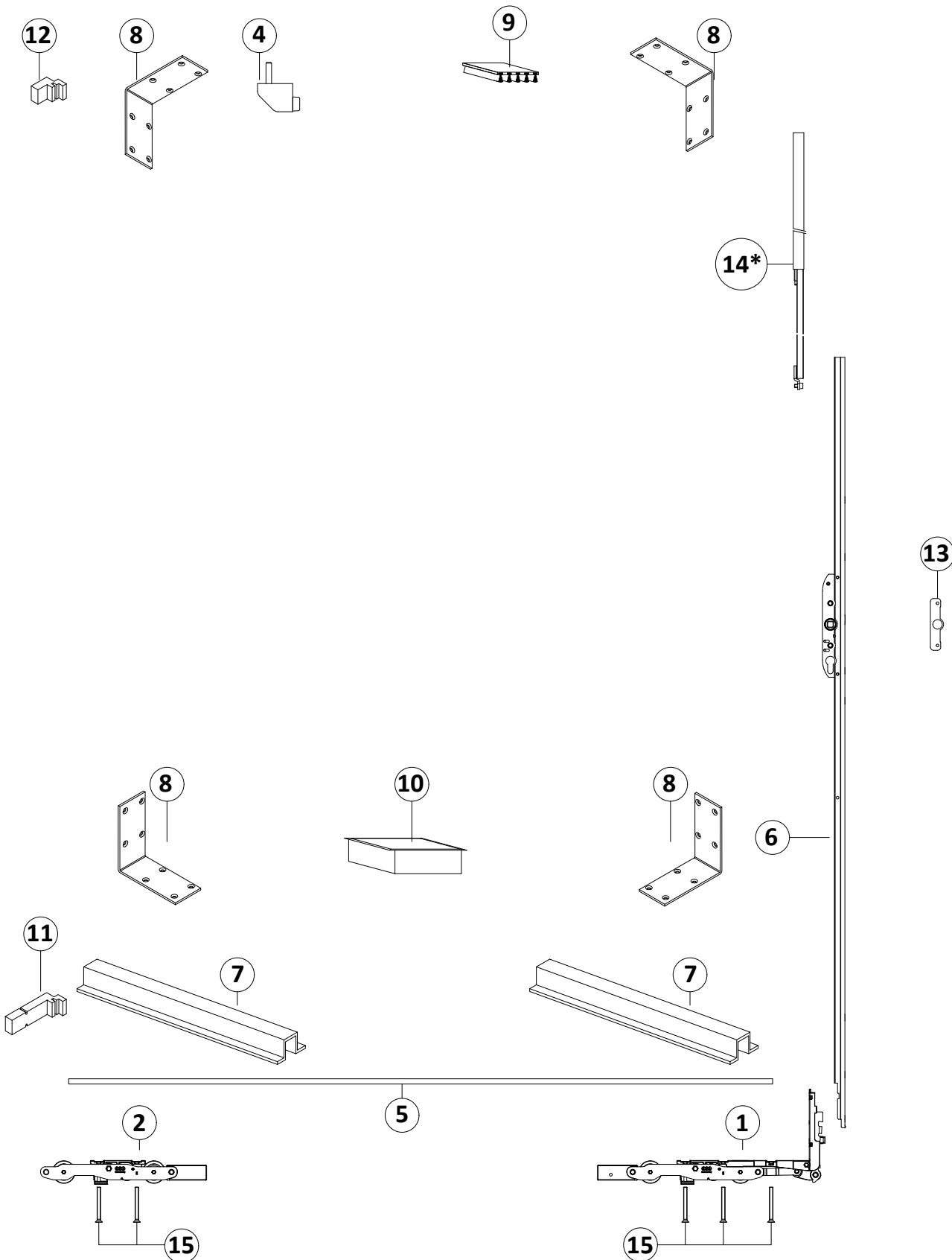
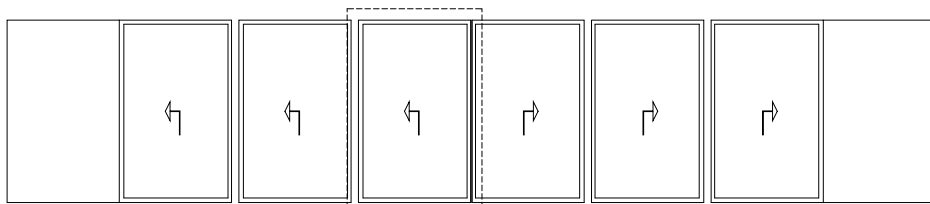

Schema | Type T3

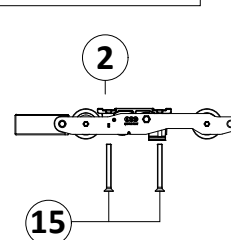
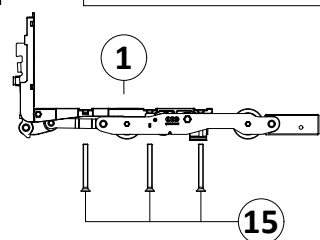
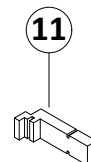
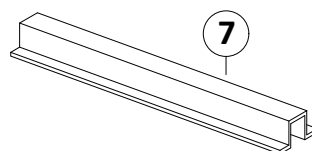
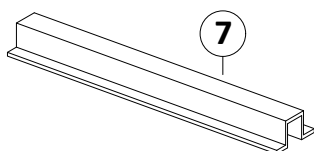
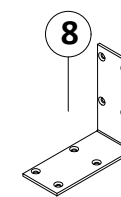
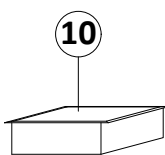
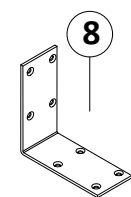
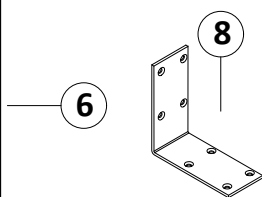
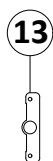
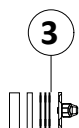
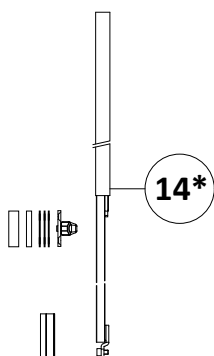
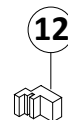
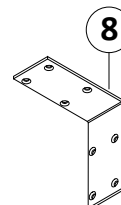
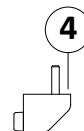
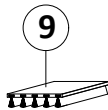
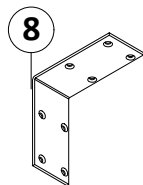
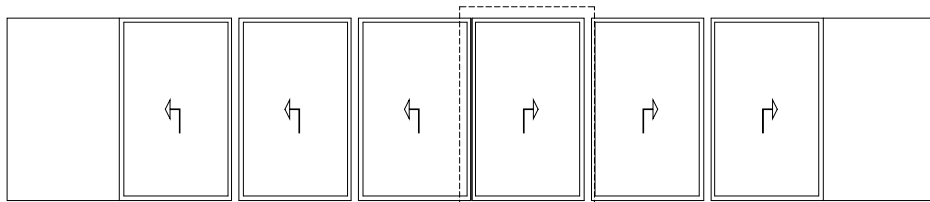

Schema | Type T3

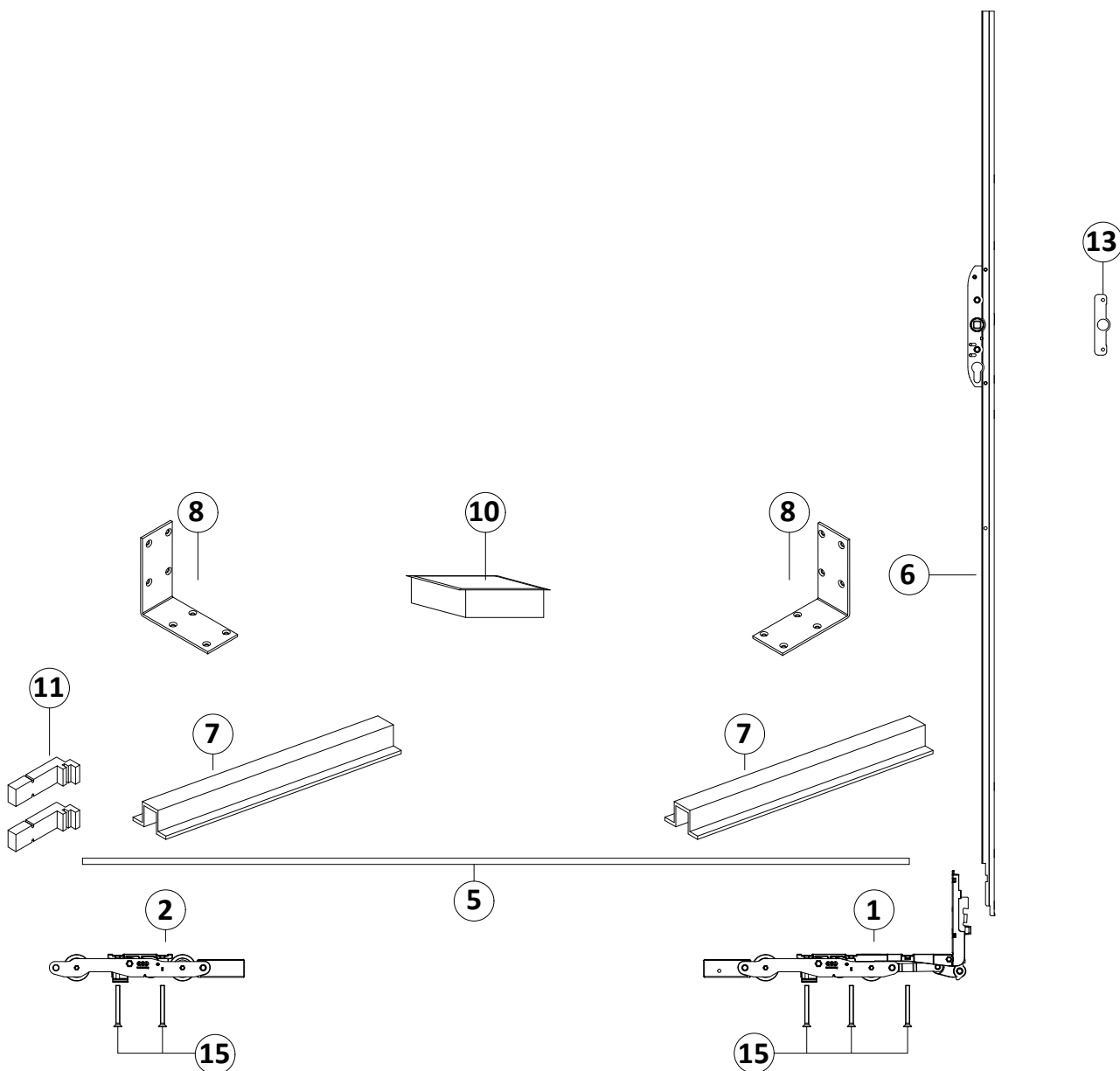
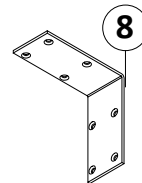
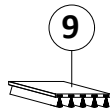
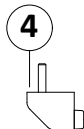
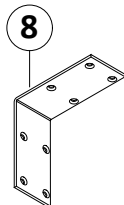
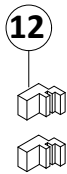
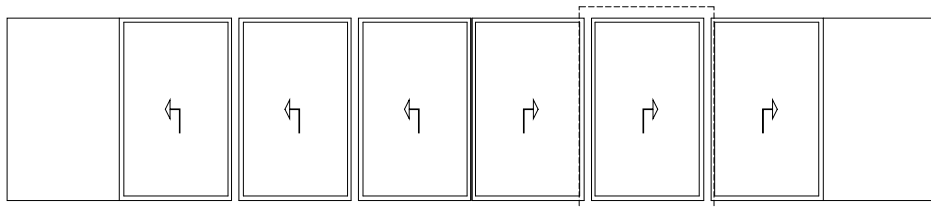

Schema | Type T3

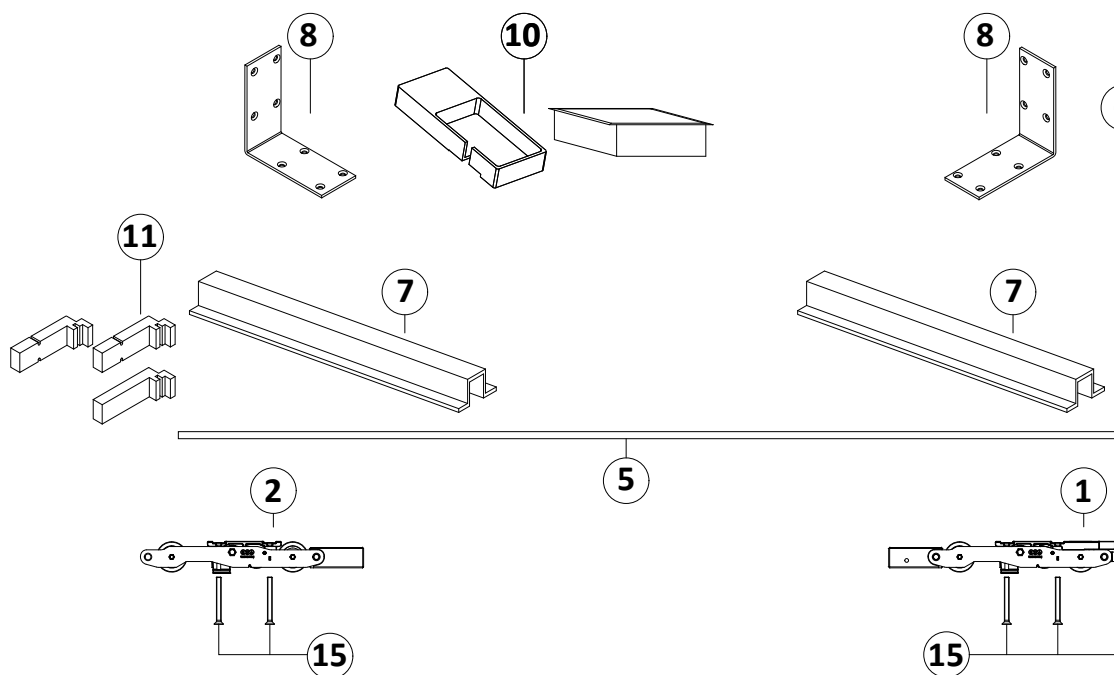
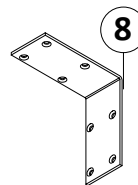
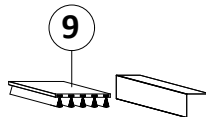
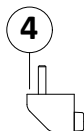
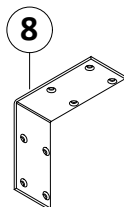
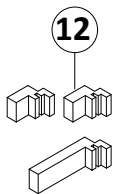
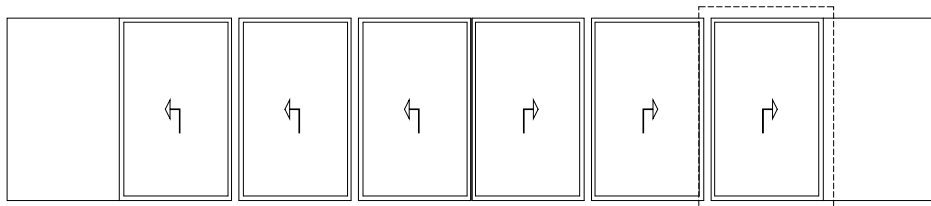

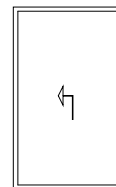
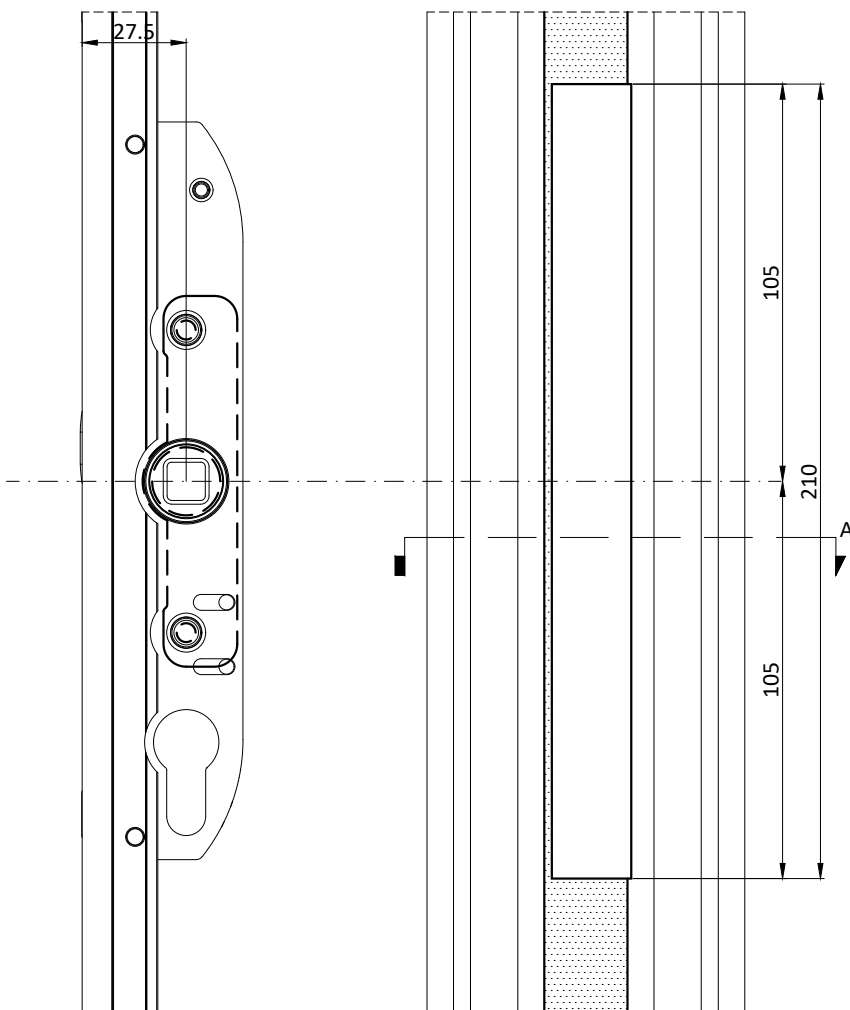

piatto fissaggio maniglia singolo  
con fori M5 applicare a pressione  
*single handle fixing plate*  
*with M5 holes press-fit*

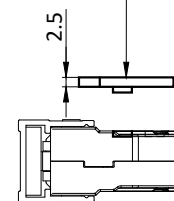
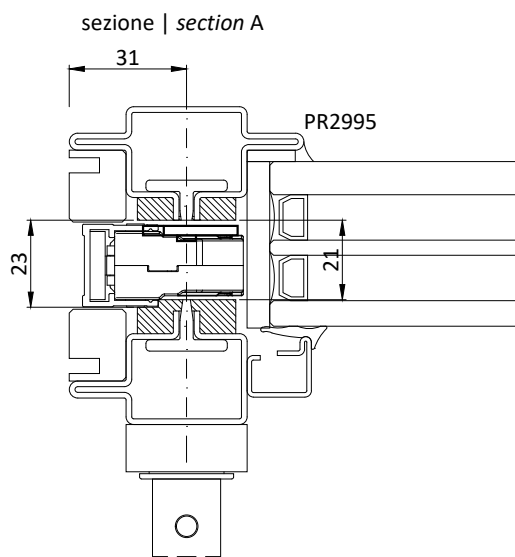
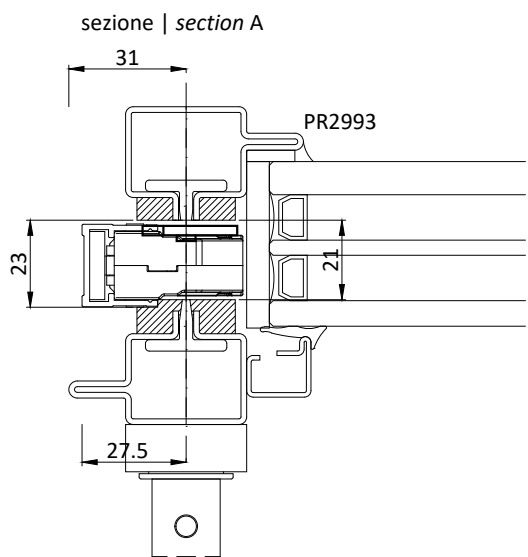

ACV212.xx finiture  
ACV212.xx finishing

ACV213.xx finiture  
ACV213.xx finishing

ACV215.xx finiture  
ACV215.xx finishing

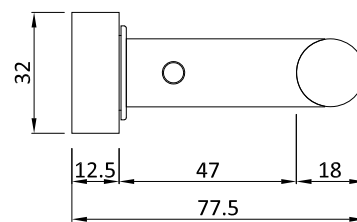
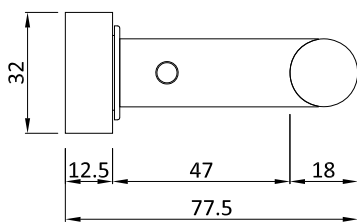
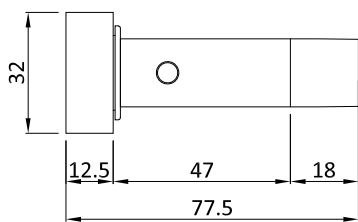

- BR ottone grezzo | untreated brass
- BB ottone brunito | burnished brass
- CZ acciaio corten | corten steel
- SB acciaio inox | stainless steel
- IX acciaio inox brunito | burnished stainless steel

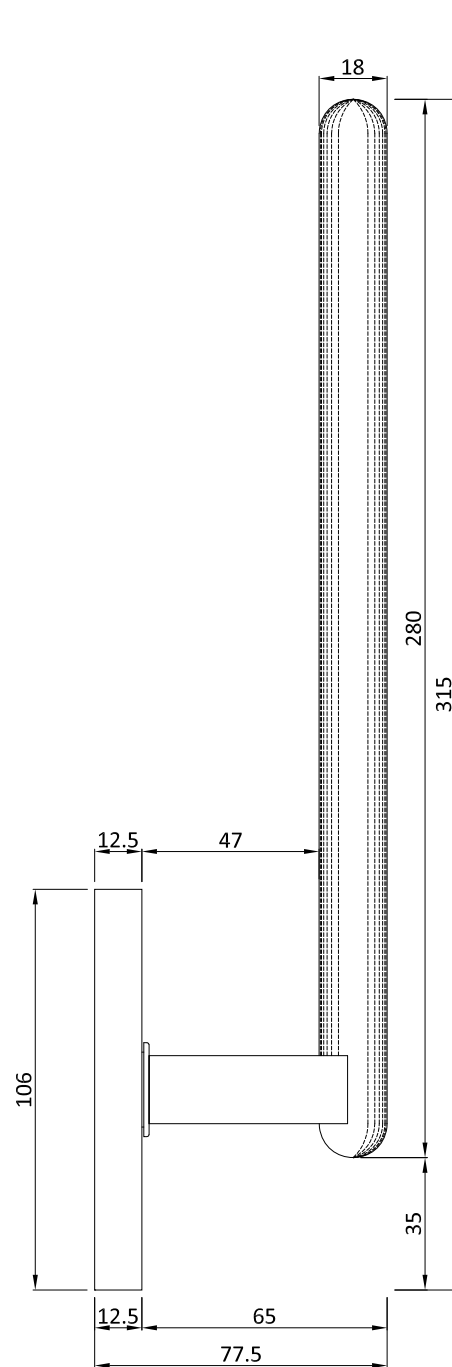
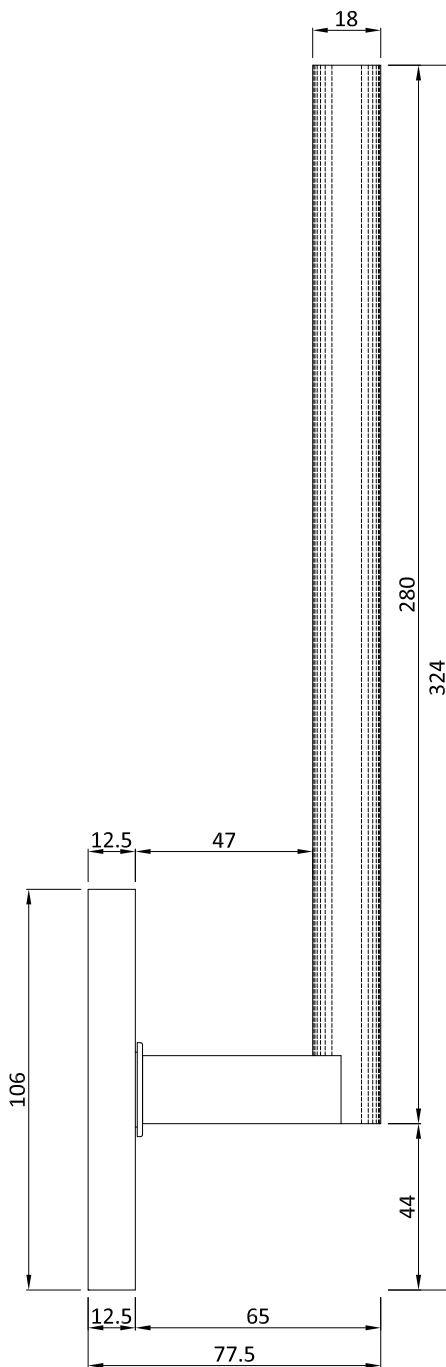
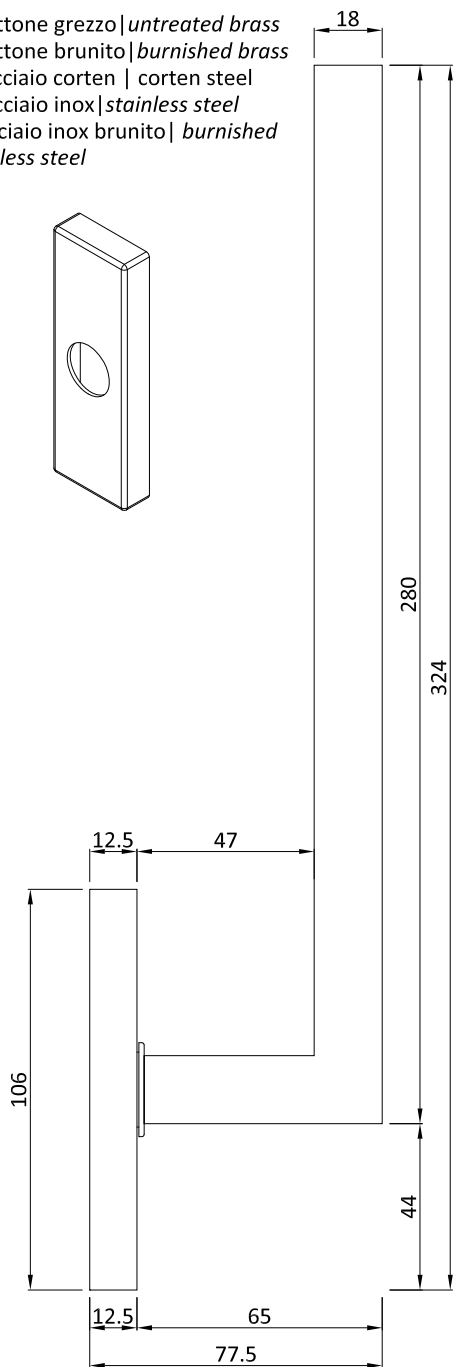
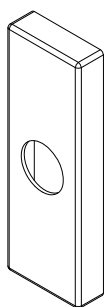

ACV222.xx finiture  
ACV222.xx finishing

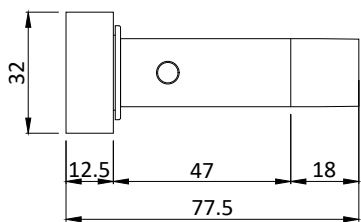

ACV223.xx finiture  
ACV223.xx finishing

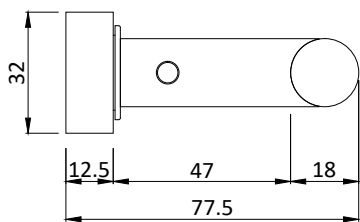

ACV225.xx finiture  
ACV225.xx finishing

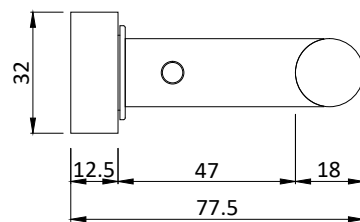

BR ottone grezzo | untreated brass  
BB ottone brunito | burnished brass  
CZ acciaio corten | corten steel  
SB acciaio inox | stainless steel  
IX acciaio inox brunito | burnished stainless steel

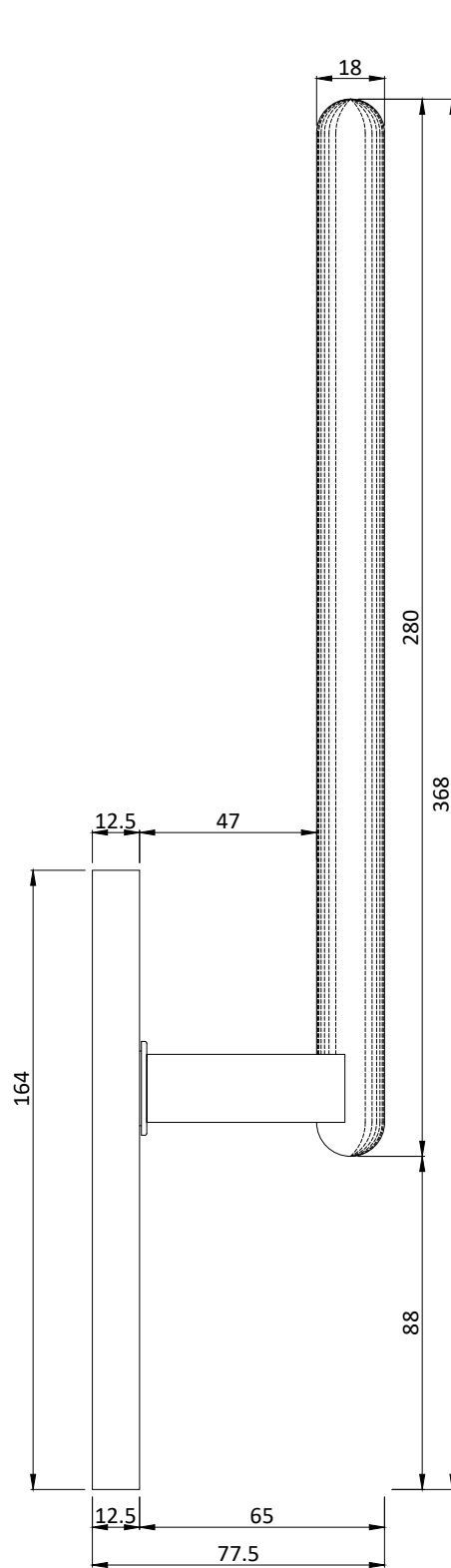
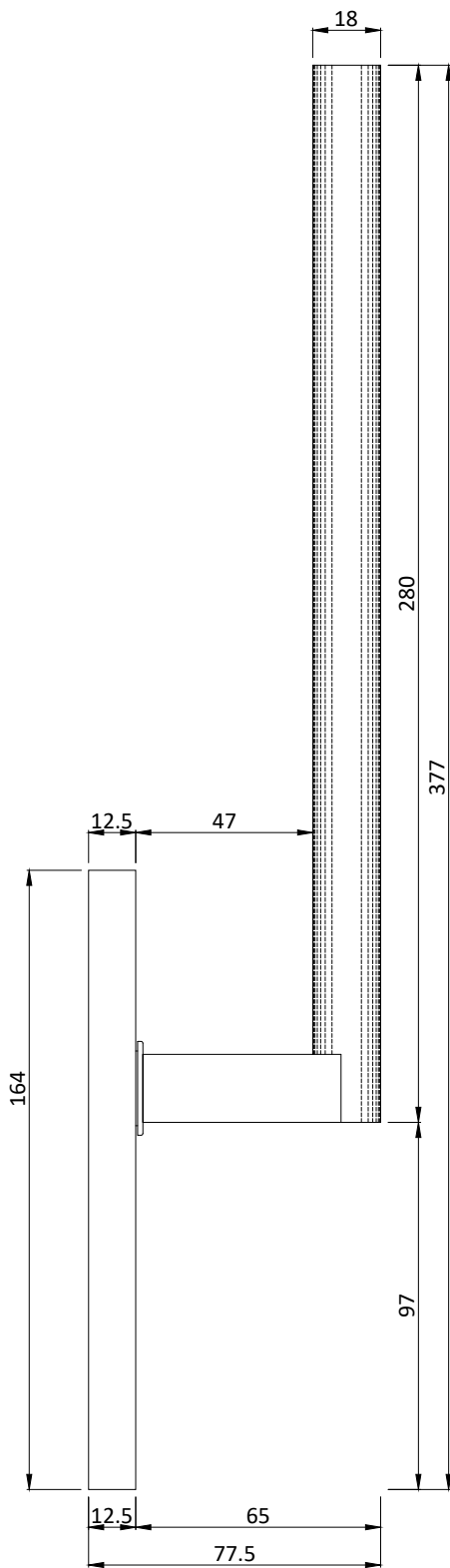
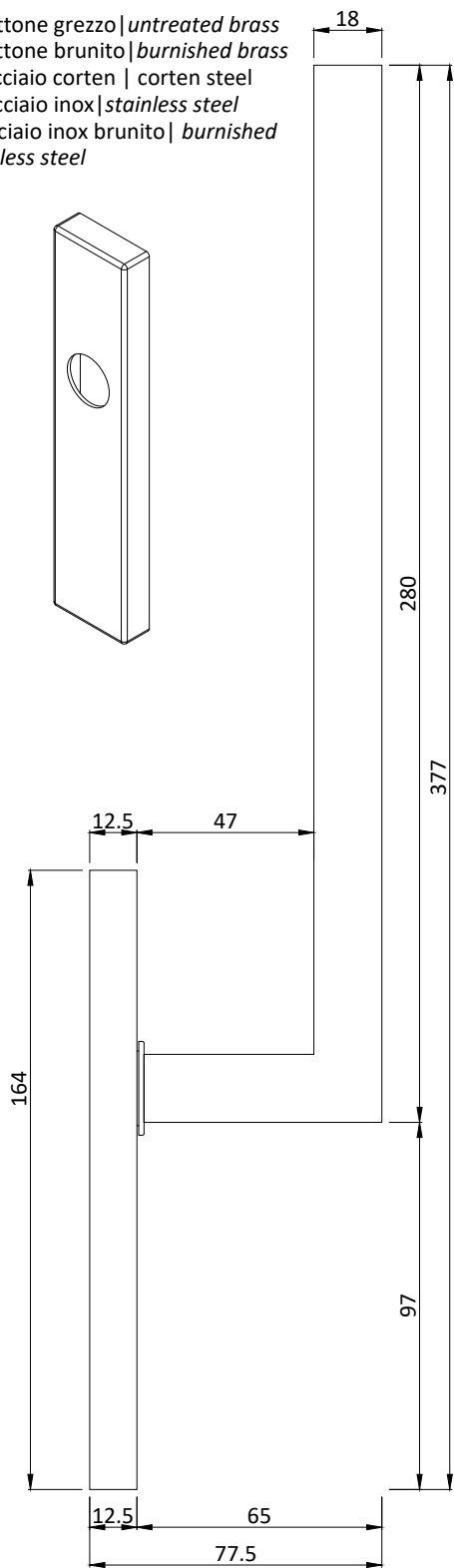
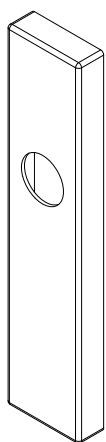

ACV222Y.xx | ACV232Y.xx finiture  
ACV222Y.xx | ACV232Y.xx finishing

ACV223Y.xx | ACV233Y.xx finiture  
ACV223Y.xx | ACV233Y.xx finishing

ACV225Y.xx | ACV235Y.xx finiture  
ACV225Y.xx | ACV235Y.xx finishing

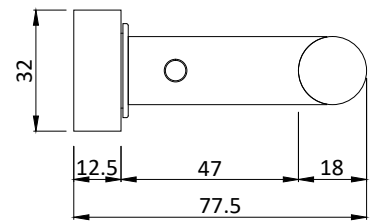
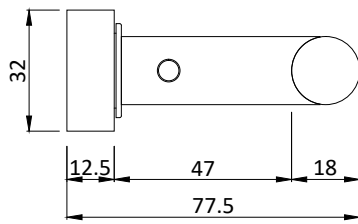
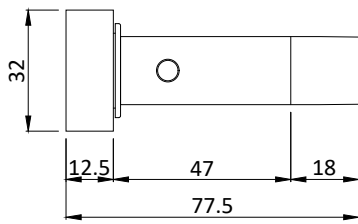

BR ottone grezzo | untreated brass  
BB ottone brunito | burnished brass  
CZ acciaio corten | corten steel  
SB acciaio inox | stainless steel  
IX acciaio inox brunito | burnished stainless steel

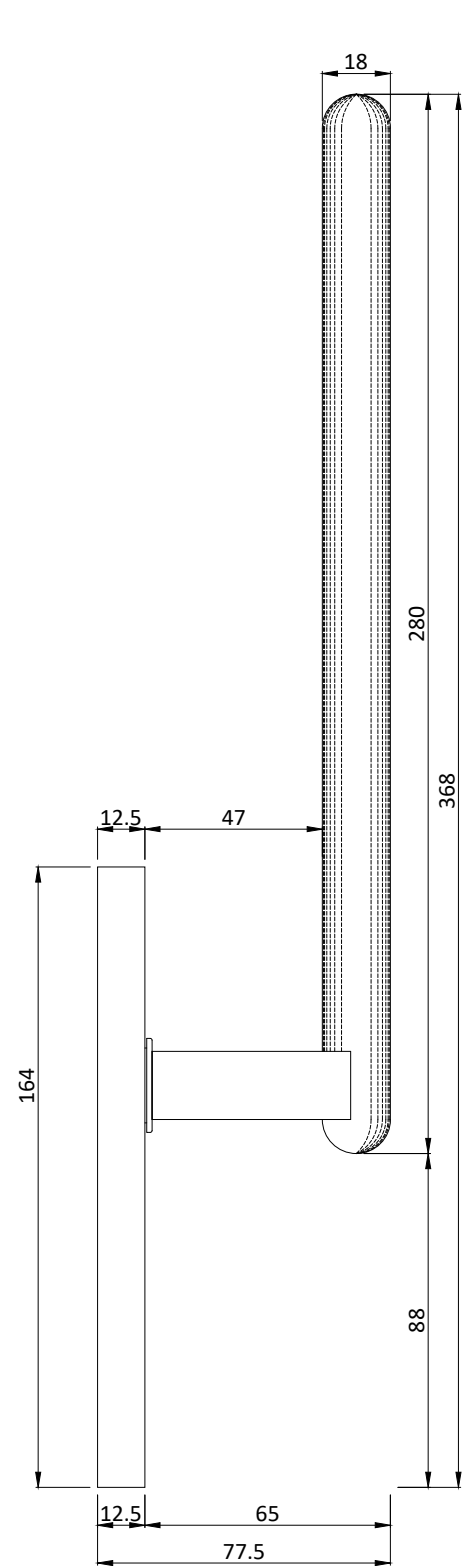
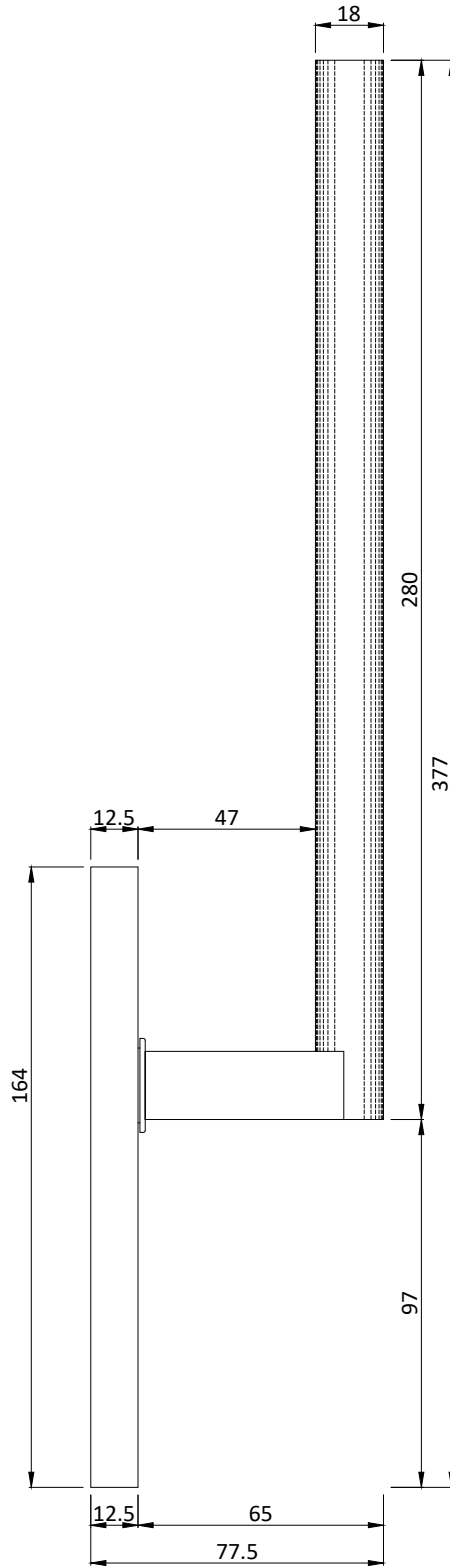
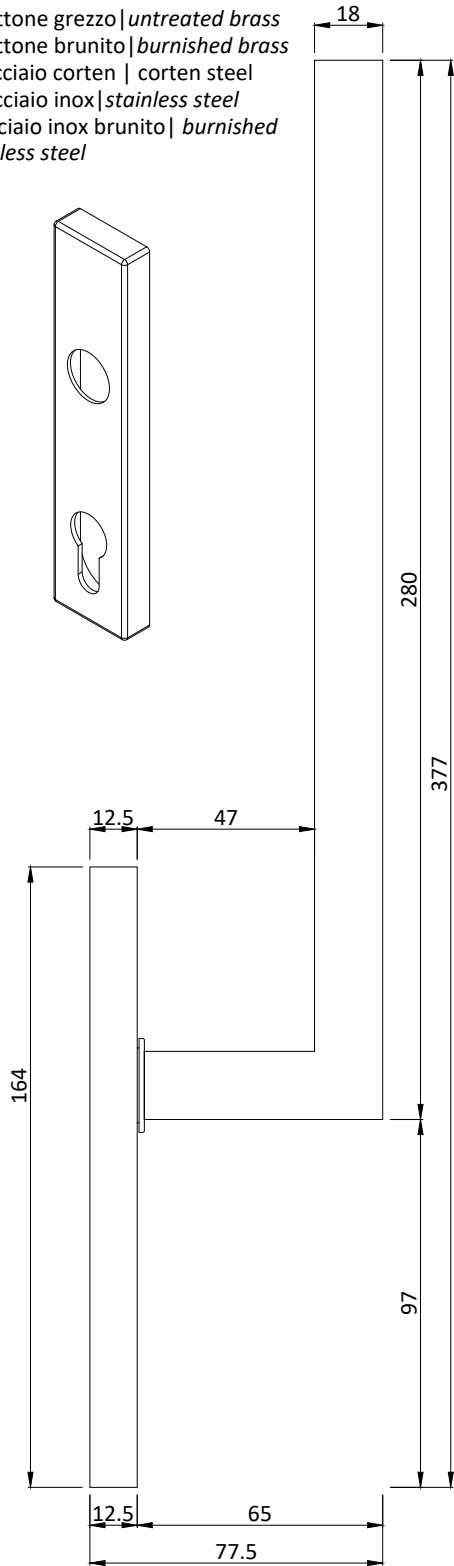
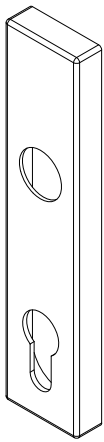



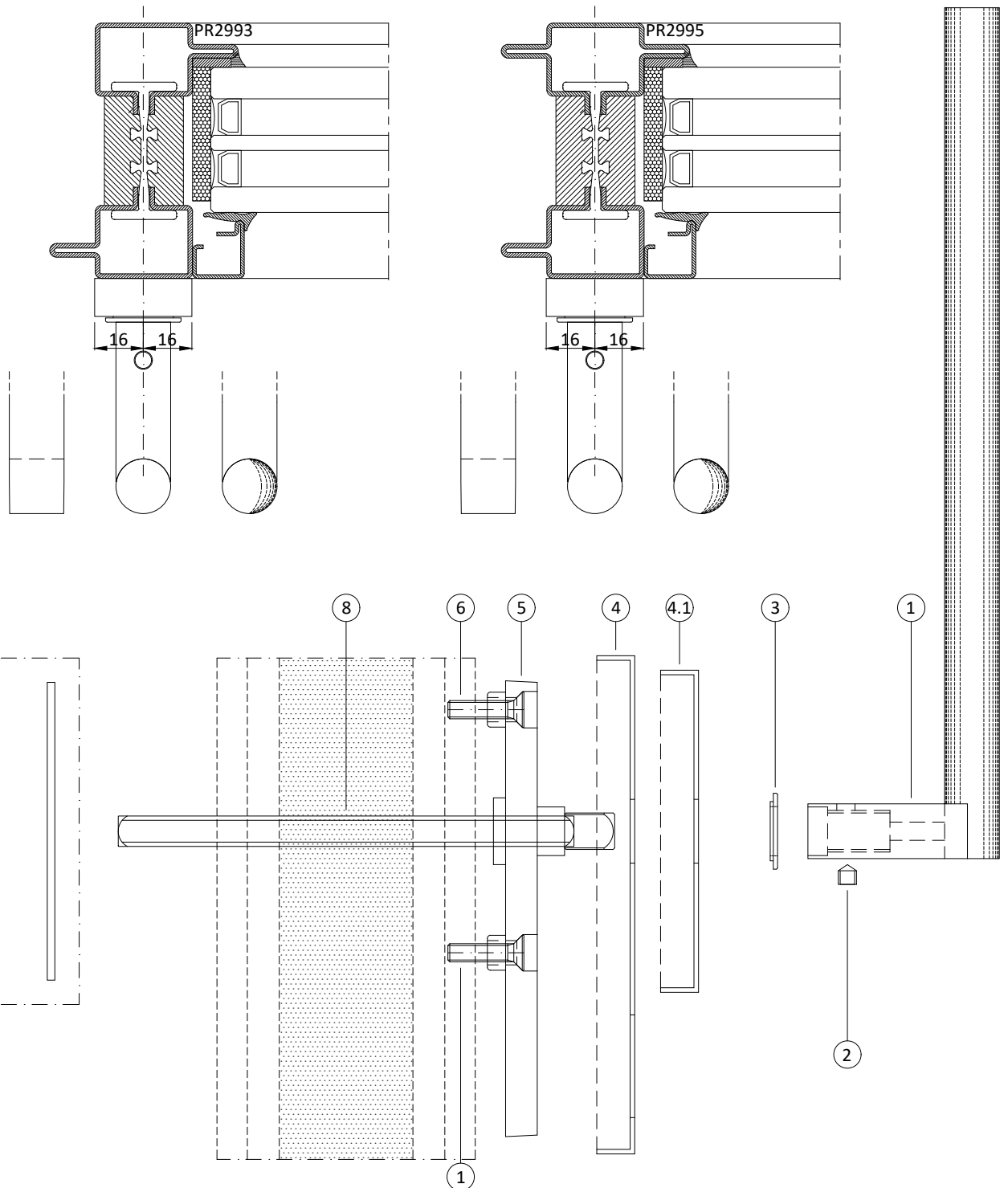
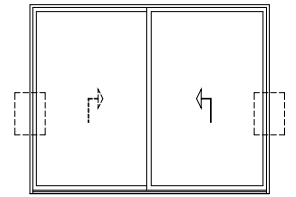

## ACV22x/Y componenti | components

1. impugnatura | handle
2. grano M6 | dowel M6
3. rondela | ring
4. rosetta | escutcheon
- 4.1 rosetta | escutcheon

5. corpo maniglione | handle
6. vite TPSC M5x50 | TPSC M5x50 screws
7. piastra fissaggio maniglione singolo  
plate to attach single handle
8. quadro 10x150 | square 10x150

## ACV12x/Y finiture | finishing

- SB acciaio inox | stainless steel
- CZ acciaio corten | corten steel
- BR ottone grezzo | untreated brass

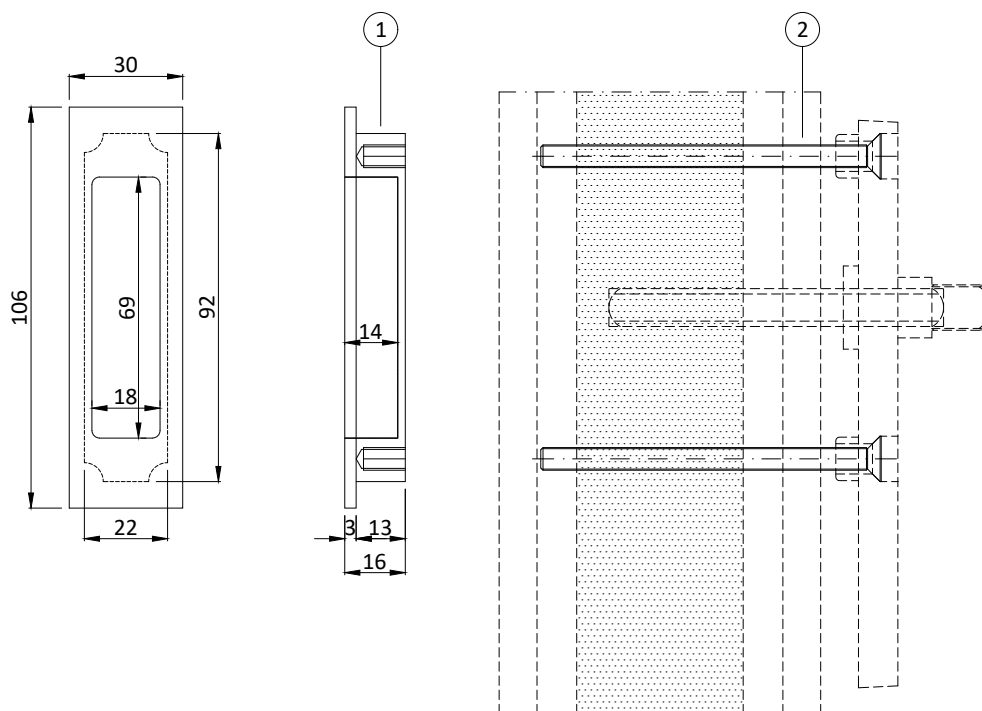
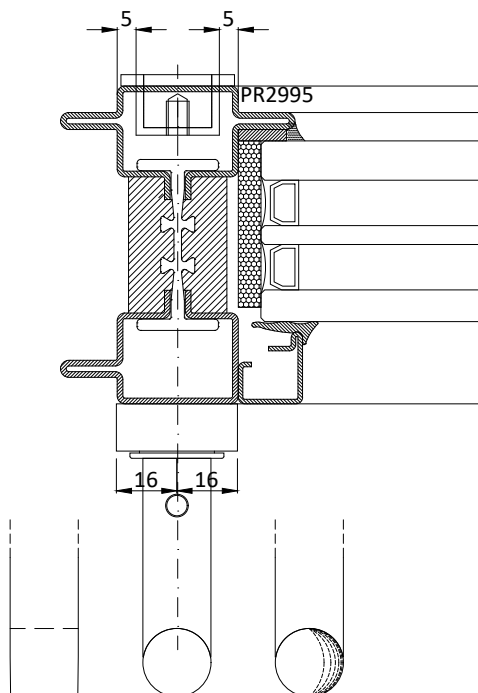

## ACV110 componenti | components

1. vaschetta | flush handle
2. vite TPSC M6x90 | TPSC M6x90 screws

## ACV110 finiture | finishing

- SB acciaio inox | stainless steel
- CZ acciaio corten | corten steel
- BR ottone grezzo | untreated brass

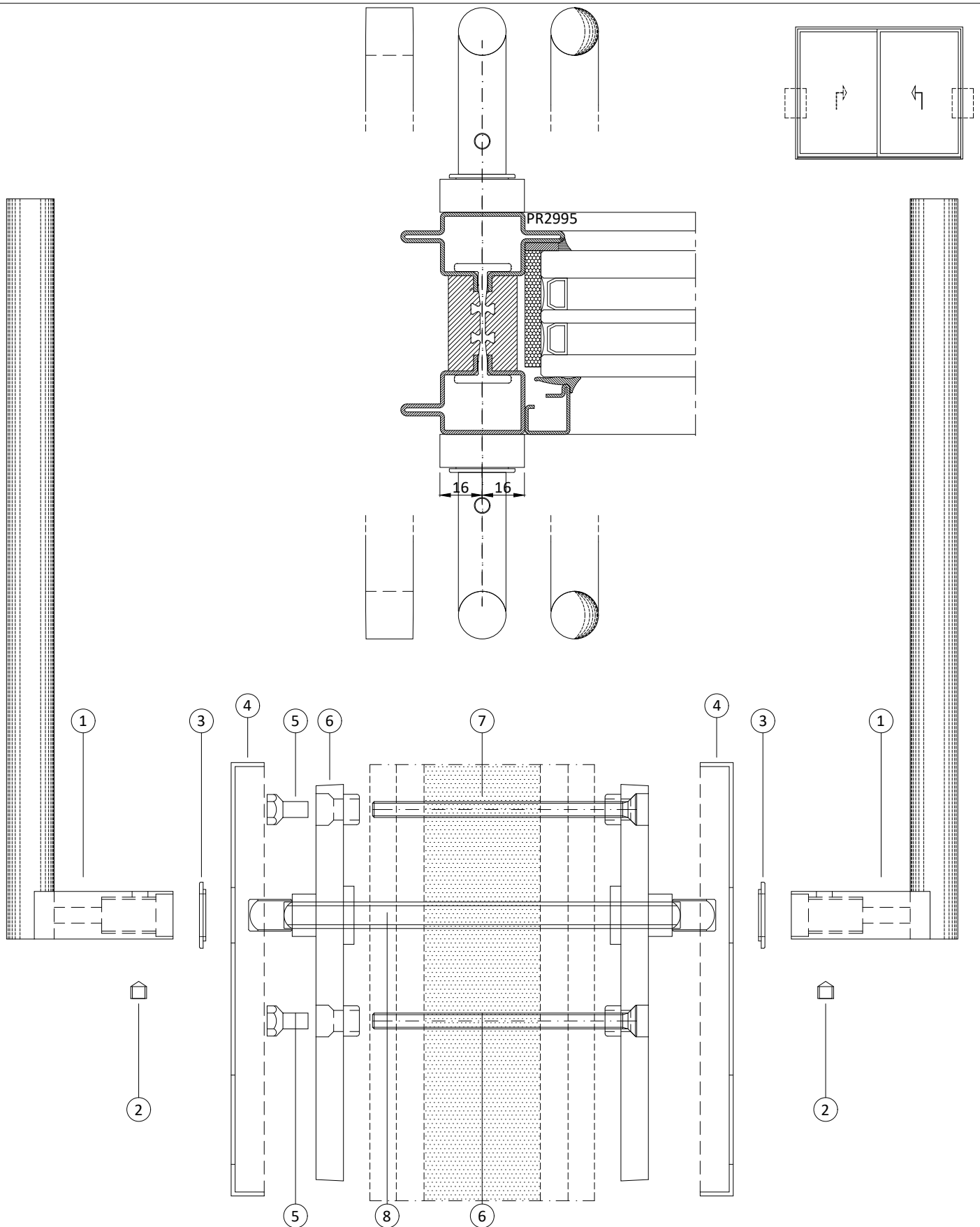

## ACV23xY componenti | components

- |                         |  |
|-------------------------|--|
| 1. impugnatura   handle | 5. inserto filettato M6   M6 thread      |
| 2. grano M6   dowel M6  | 6. corpo maniglione   handle             |
| 3. rondela   ring       | 7. viti TPSC M6x100   TPSC M6x100 screws |
| 4. rosetta   escutcheon | 8. quadro 10x150   square 10x150         |

## ACV23xY finiture | finishing

- SB acciaio inox | stainless steel
- CZ acciaio corten | corten steel
- BR ottone grezzo | untreated brass

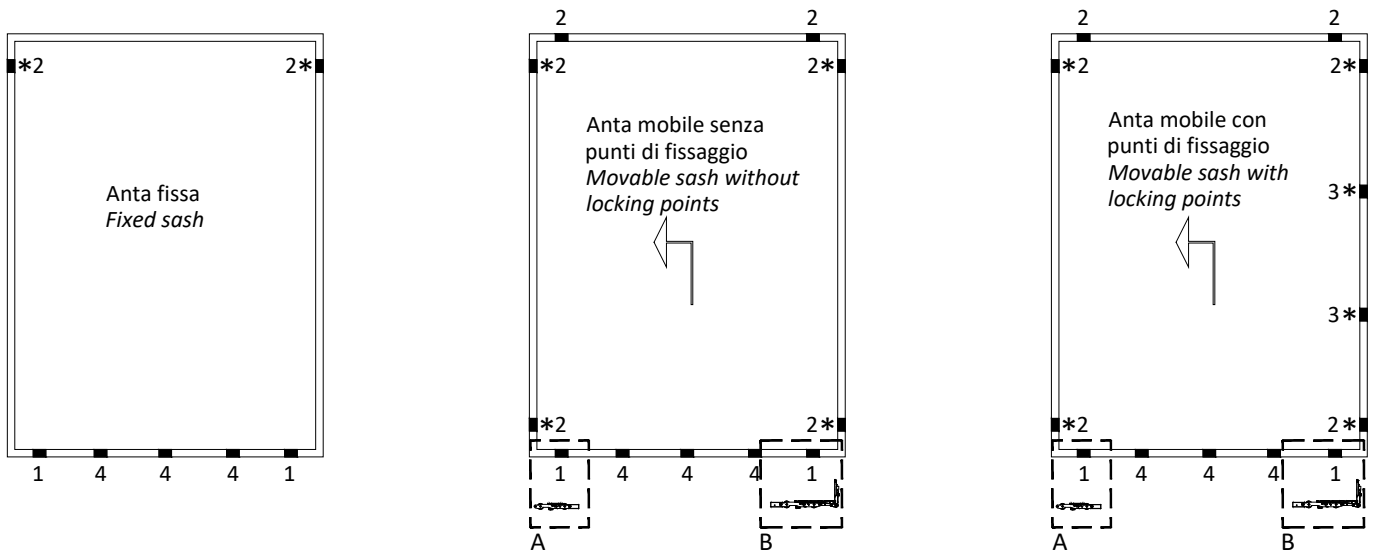

PARTICOLARE "A"  
PARTICULAR "A"

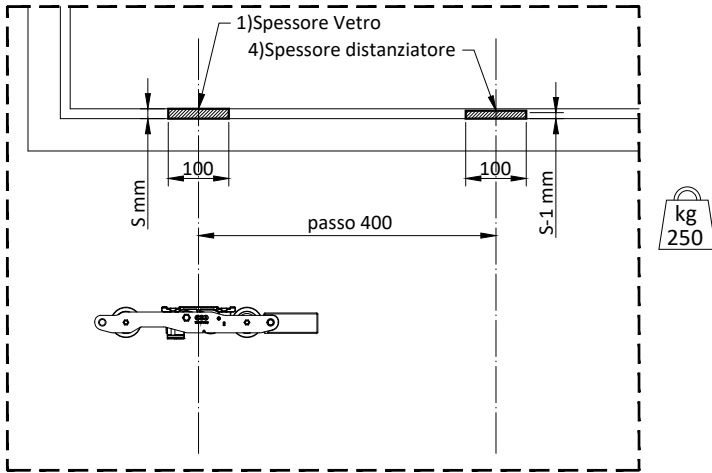

PARTICOLARE "B"  
PARTICULAR "B"

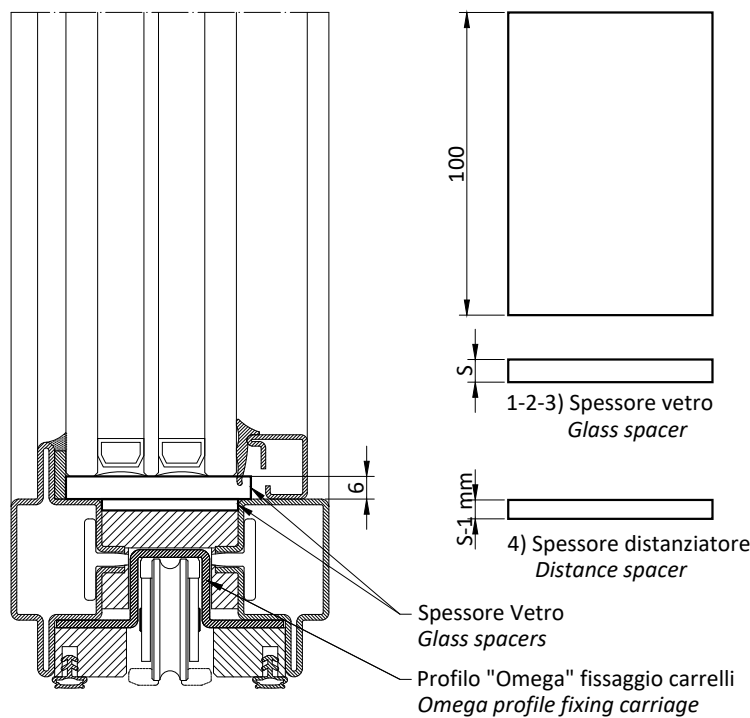
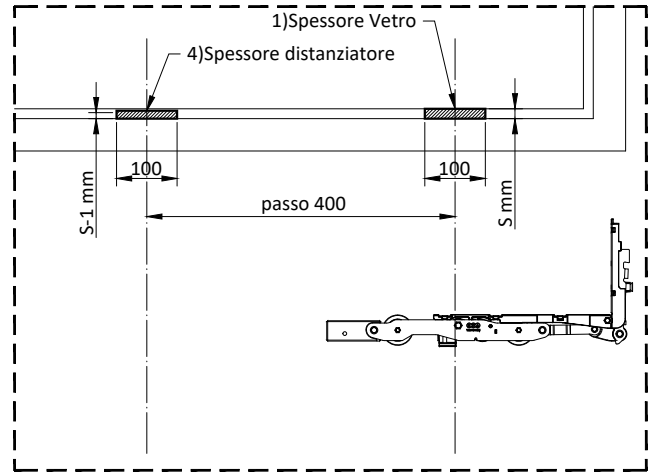

- 1) Spessore portante (allineato ai carrelli dove presenti)
- 2) Spessore distanziatore
- 3) Spessore distanziatore per punti di chiusura
- 4) Spessore distanziatore

- 1) Load-bearing spacer (aligned with carriages if present)
- 2) Distance spacer
- 3) Distance spacer for locking points
- 4) Distance spacer

\* Verticalmente fissare spessore vetro con Silicone

\* Attach glass spacer vertically with Seal

CAPITOLO MOTORIZZAZIONE OS2 75 AS L  
*AUTOMATISATION CHAPTER OS2 75 AS L*



Non manomettere, smontare o utilizzare in modo improprio il motore pena invalidità della garanzia  
*Don't tamper, don't disassemble, don't use improperly the motor otherwise the warranty will be invalid*

Schema | Type C3

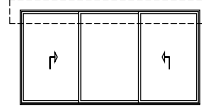

Schema | Type B

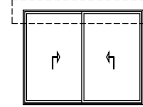

Schema | Type A

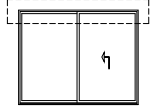

Schema | Type S1

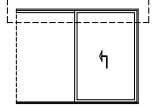

Non manomettere, smontare o utilizzare in modo improprio il motore pena invalidità della garanzia  
Don't tamper, don't disassemble, don't use improperly the motor otherwise the warranty will be invalid

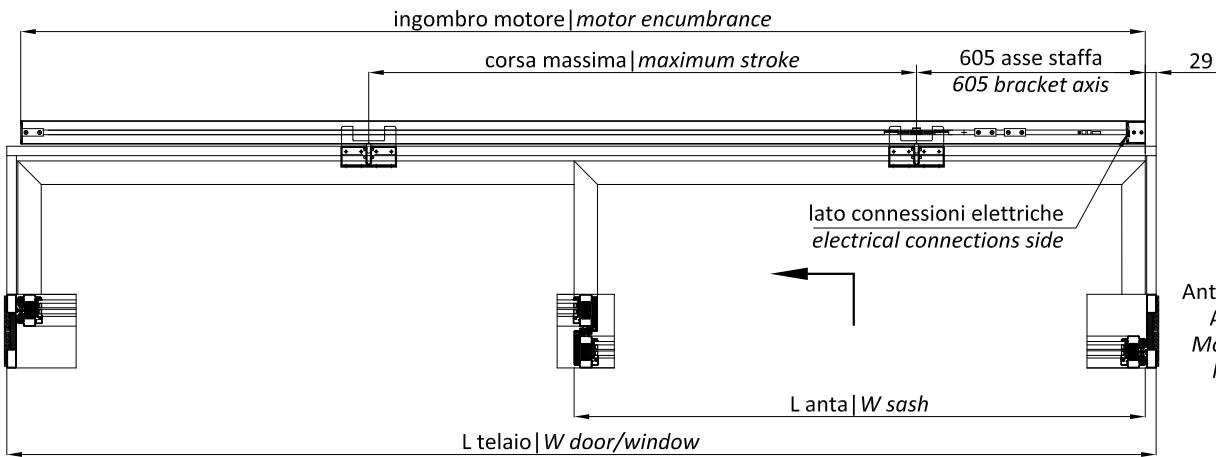

Schema | Type A

Schema | Type B\*

\*  
Anta interna motorizzata  
Anta esterna manuale  
Motorized internal door  
Manual external door

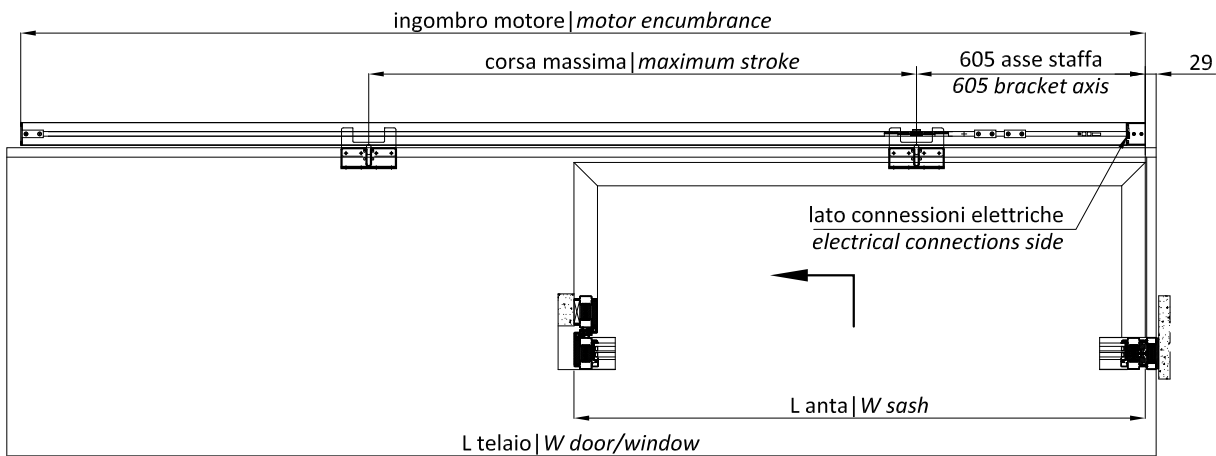

Schema | Type S1

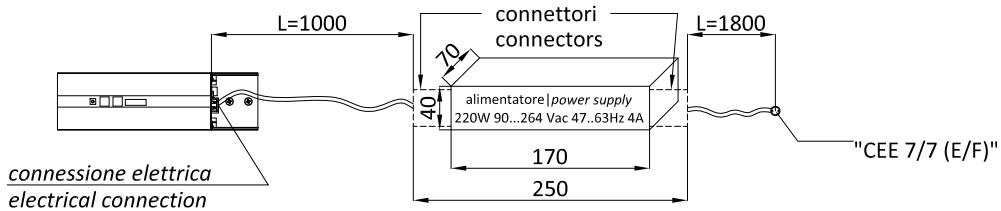

motorizzazioni alzante scorrevole/lift-and-slide automation					
larghezza anta sash width		ingombro motore motor encumbrance	corsa max maximum stroke	codice   code	
L min	L max			peso anta max max weight sash <250 kg	
1135	1430	2174	1400	MBS140	
1431	1995	2774	2000	MBS200	



Schema | Type C



Non manomettere, smontare o utilizzare in modo improprio il motore pena invalidità della garanzia  
Don't tamper, don't disassemble, don't use improperly the motor otherwise the warranty will be invalid

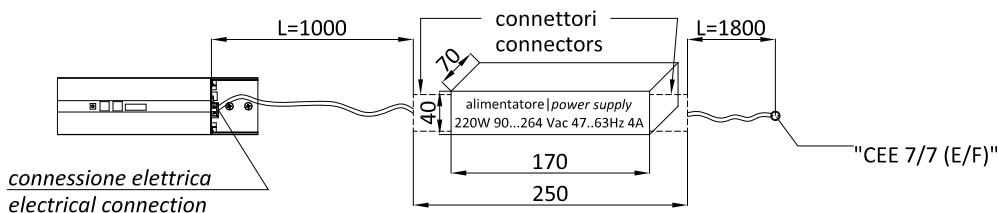
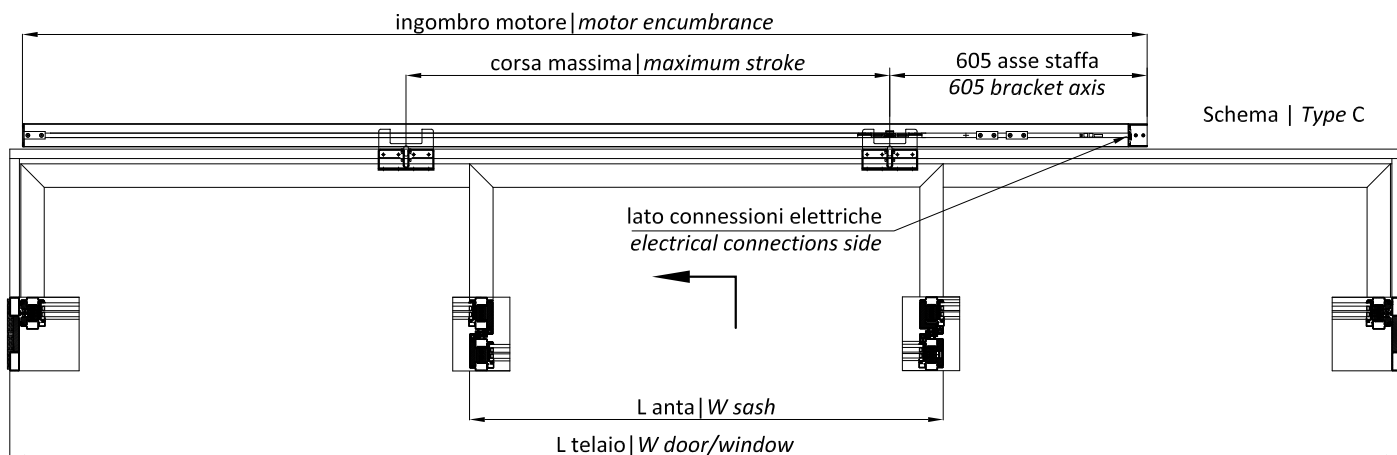

motorizzazioni alzante scorrevole/lift-and-slide automation				
larghezza anta sash width		ingombro motore motor encumbrance	corsa max maximum stroke	codice   code peso anta max max weight sash <250 kg
L min	L max			
1135	1430	2174	1400	MBS140
1431	1995	2774	2000	MBS200



Schema | Type F

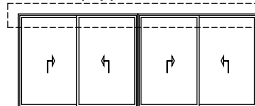

Schema | Type E

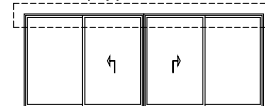

Schema | Type T1

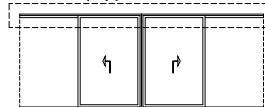

Non manomettere, smontare o utilizzare in modo improprio il motore pena invalidità della garanzia  
Don't tamper, don't disassemble, don't use improperly the motor otherwise the warranty will be invalid

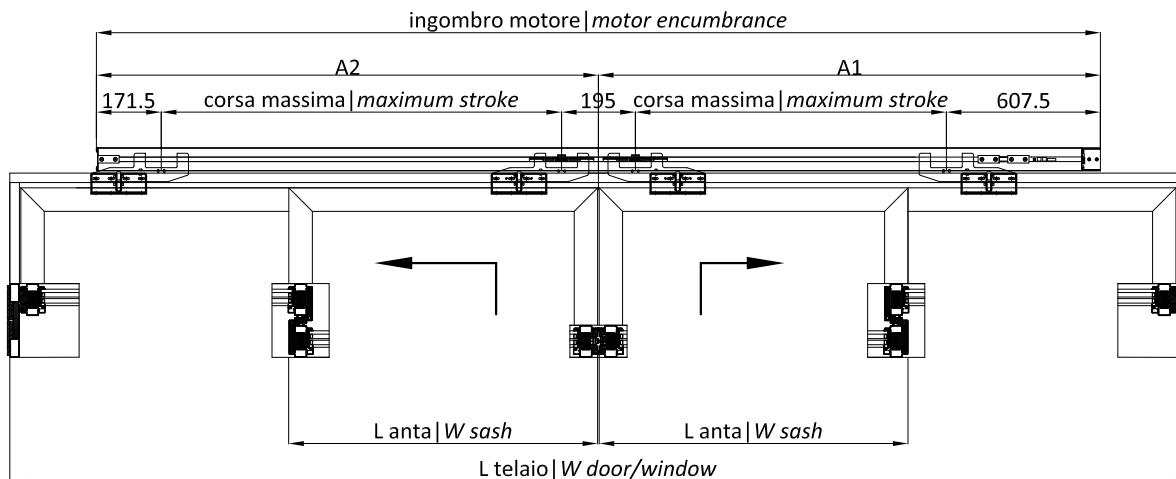

Schema | Type E

Schema | Type F\*

\*  
Ante interne motorizzate  
Ante esterne manuali  
Motorized internal doors  
Manual external doors

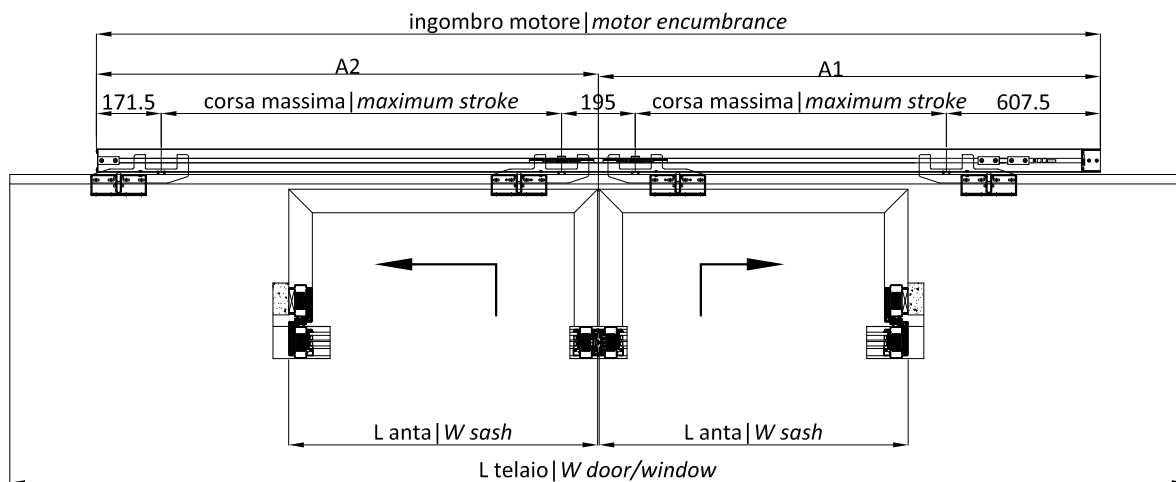

Schema | Type T1

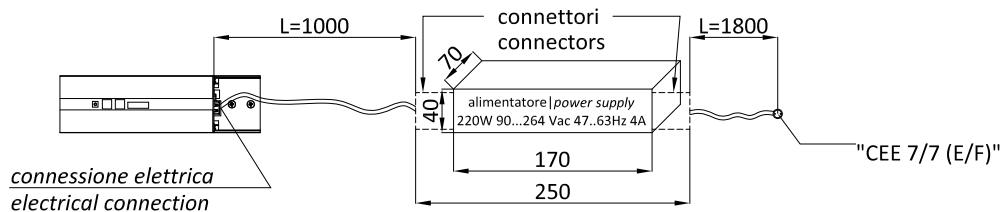

connessione elettrica  
electrical connection

motorizzazioni alzante scorrevole/lift-and-slide automatisation						
larghezza anta sash width		ingombro motore Motor encumbrance	corsa max maximum stroke	posizionamento motore motor position		codice   code peso anta max max weight sash <250 kg
L min	L max			A1	A2	
1135	1500	3974	1500+1500	2105	1869	<b>MBX150</b>
1501	1995	4974	2000+2000	2605	2369	<b>MBX200</b>





Schema | Type F

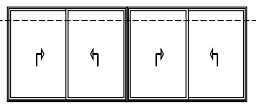

Schema | Type E

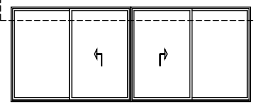

Schema | Type C3

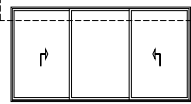

Schema | Type C

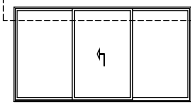

Schema | Type B

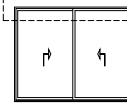

Schema | Type A

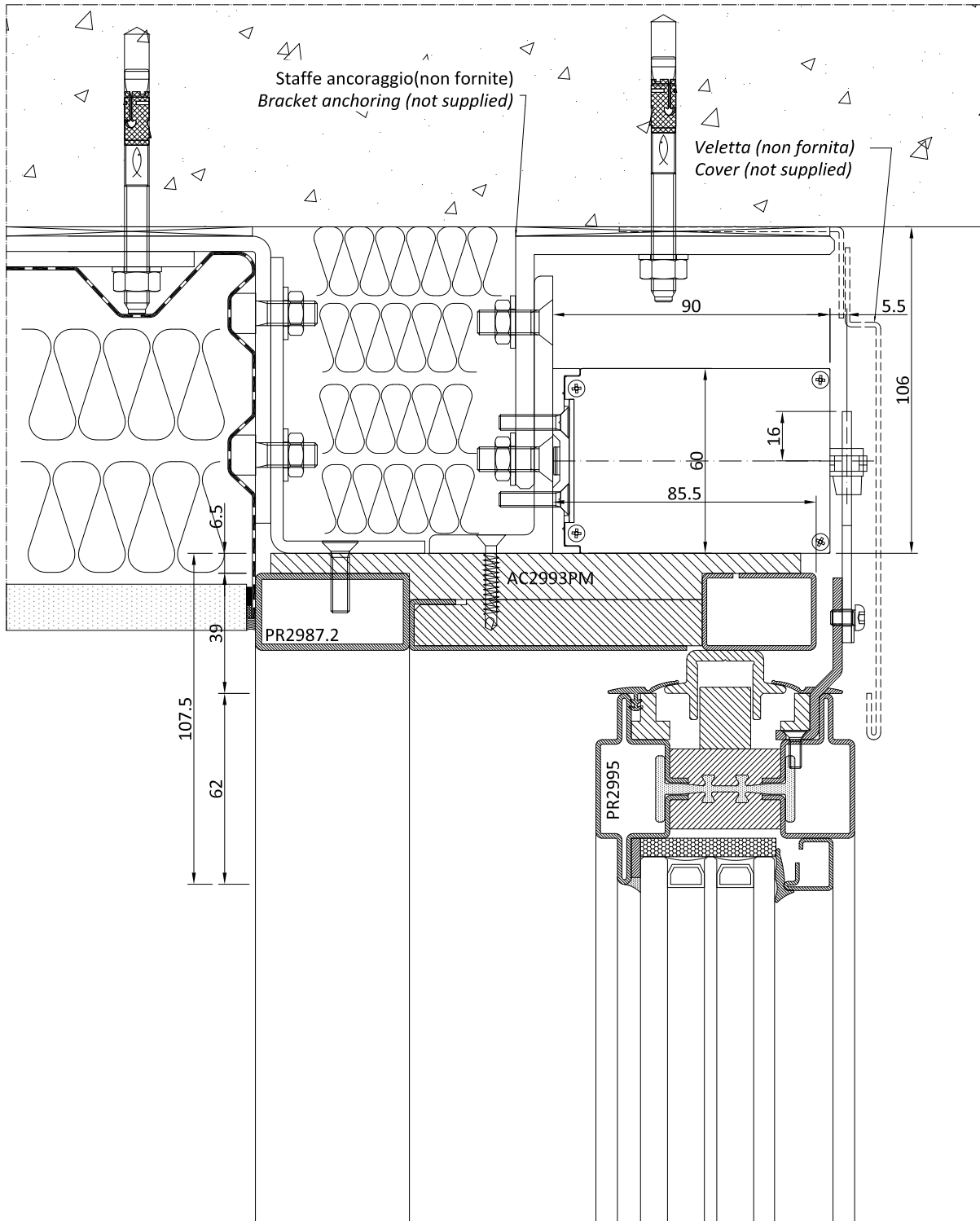
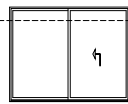

Schema | Type T1

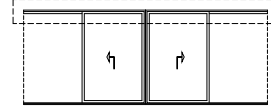

Schema | Type S1

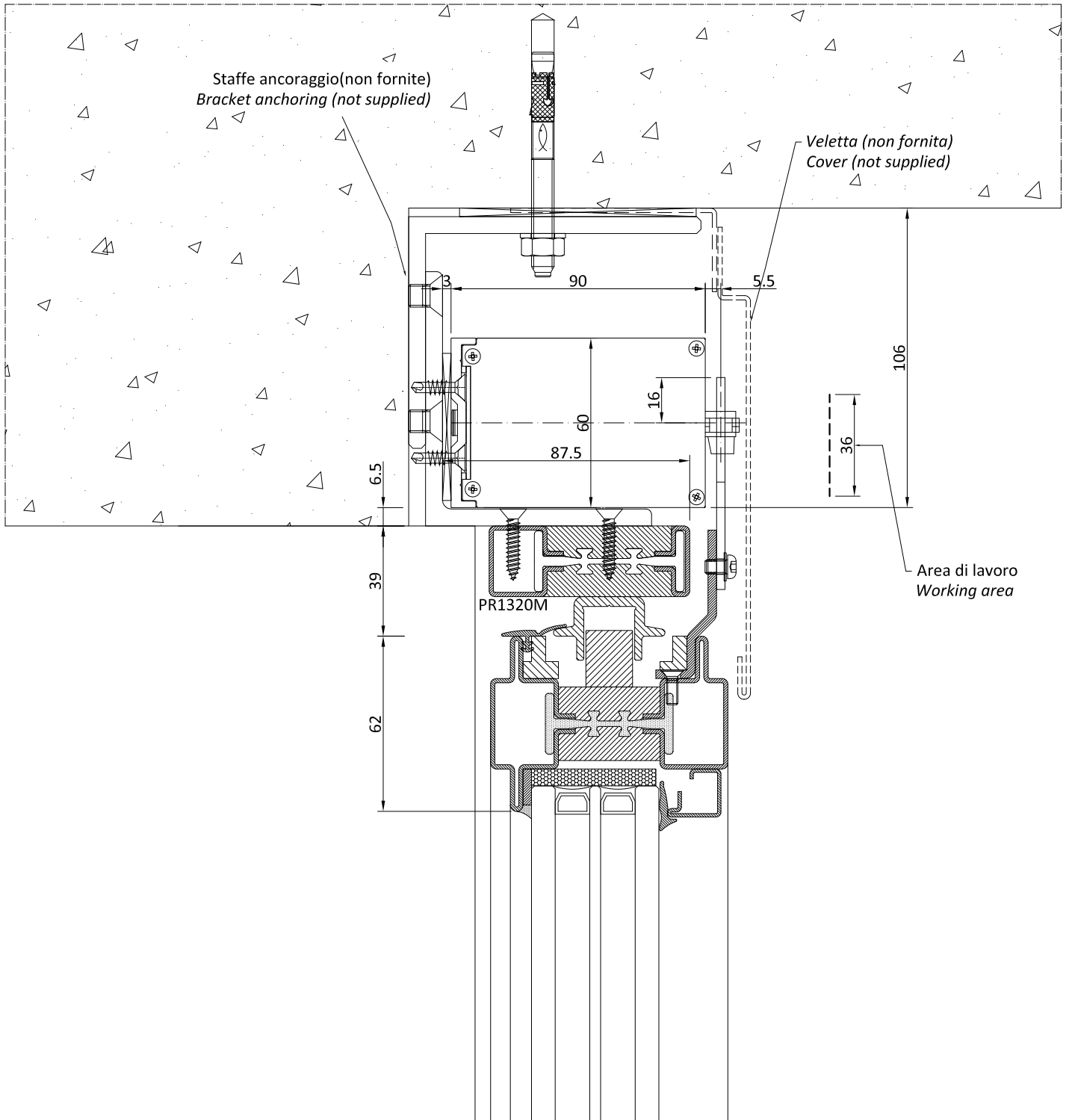
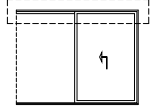

Schema | Type C3

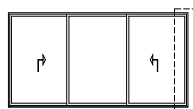

Schema | Type B

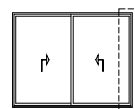

Schema | Type A

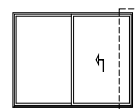

Schema | Type S1

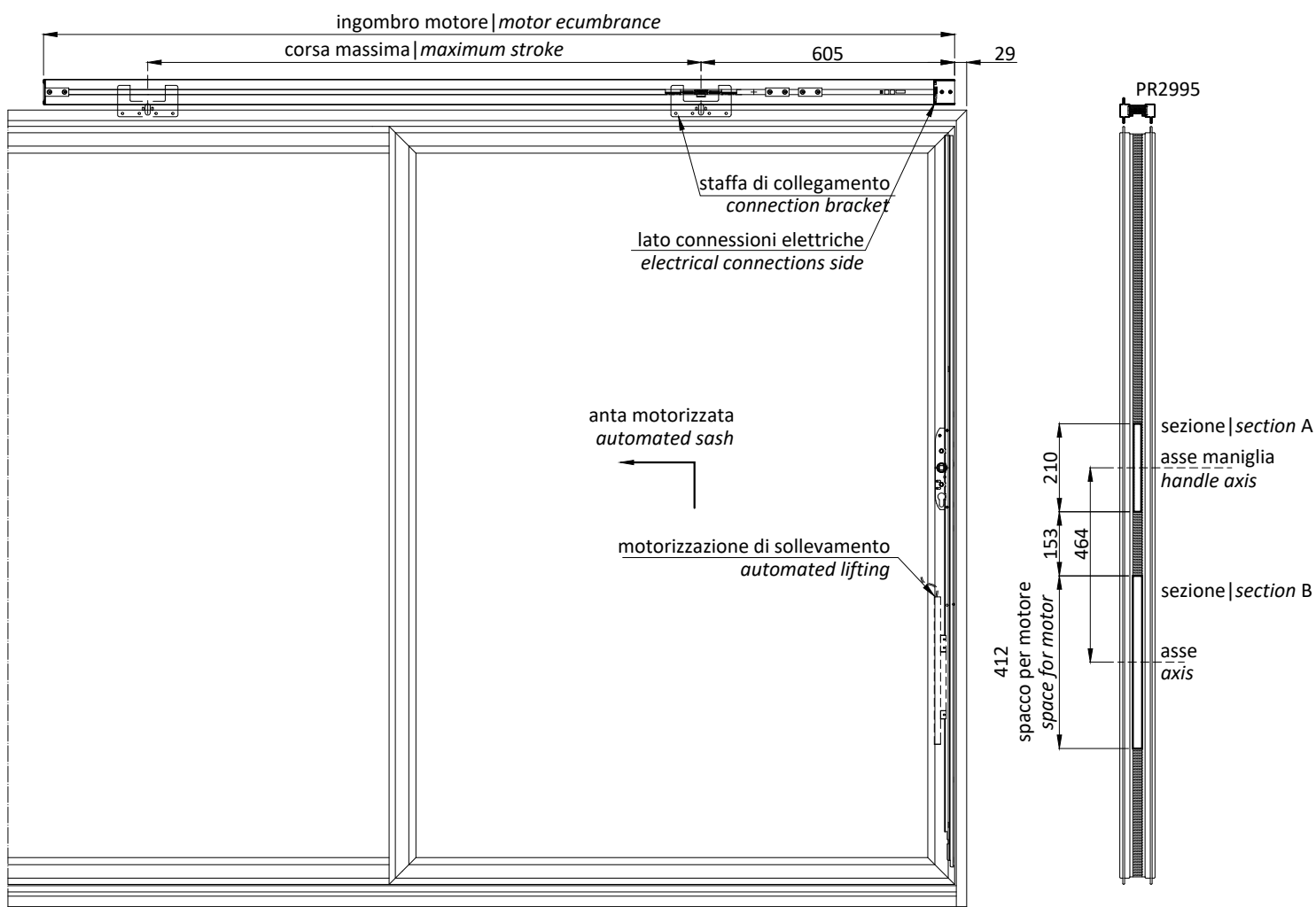
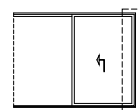

foro per sollevamento manuale  
hole for manual lifting

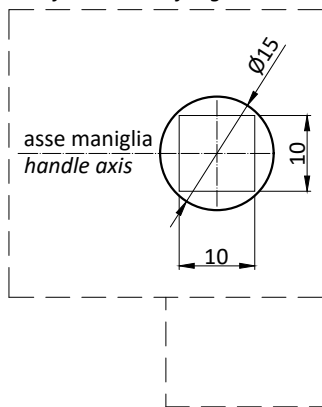

sezione | section A  
cremonese  
cremone

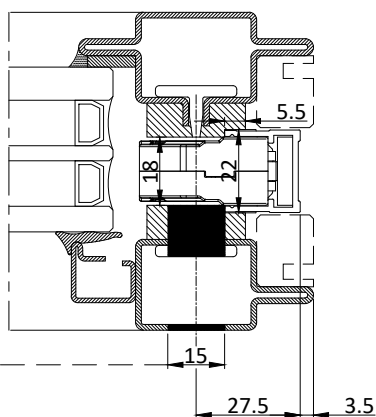

sezione | section B  
motore sollevamento  
automated lifting

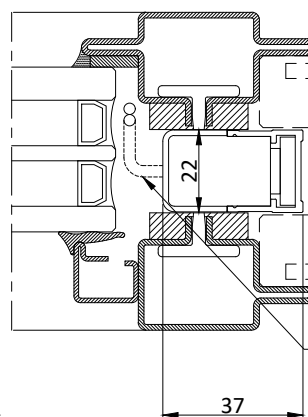

ATTENZIONE  
segnalato con apposito adesivo il foro di  
fissaggio da non utilizzare in quanto  
interferisce con il motore di sollevamento

ATTENTION  
the fixing hole must not be used as it  
interferes with the lifting motor and must  
be marked with a sticker

cavi di alimentazione  
power source wiring

Schema | Type C

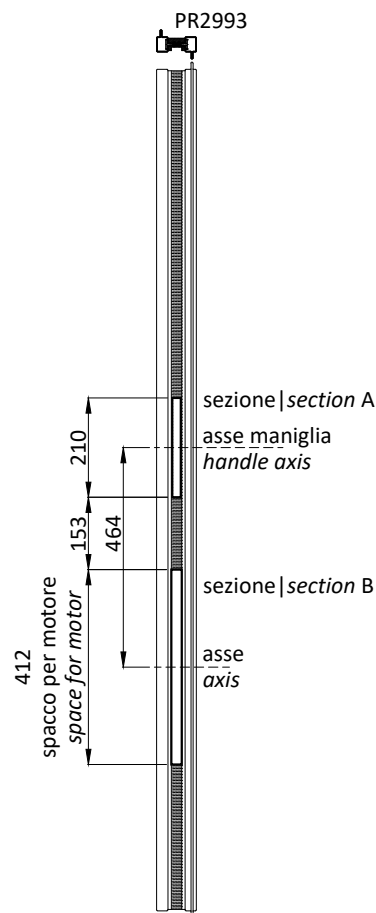
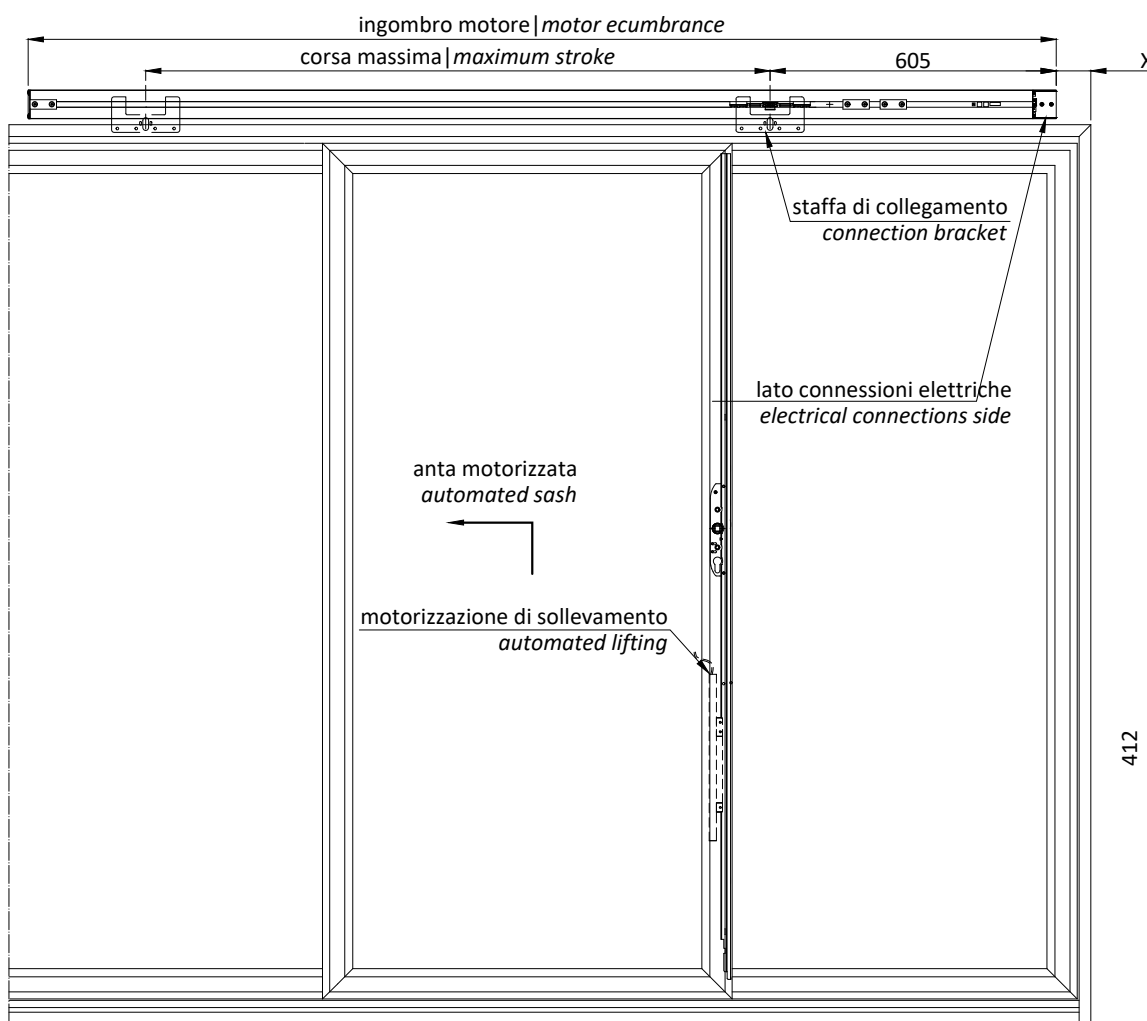
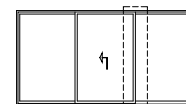

foro per sollevamento manuale  
hole for manual lifting

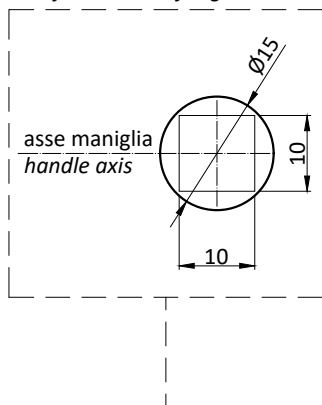

sezione | section A  
cremonese  
cremone

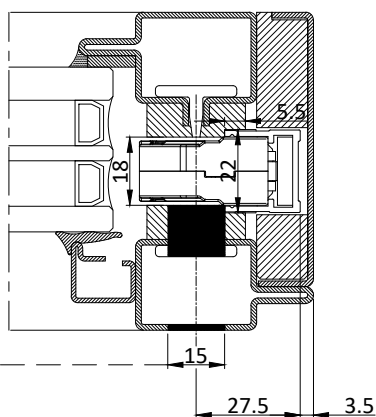

sezione | section B  
motore sollevamento  
automated lifting

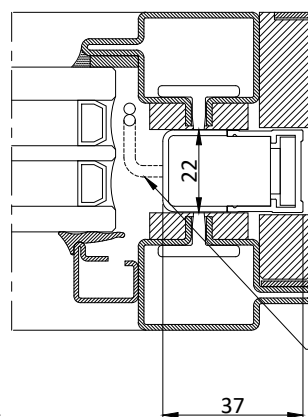

ATTENZIONE  
segnalato con apposito adesivo il foro di  
fissaggio da non utilizzare in quanto  
interferisce con il motore di sollevamento

ATTENTION  
the fixing hole must not be used as it  
interferes with the lifting motor and must  
be marked with a sticker

cavi di alimentazione  
power source wiring

Schema | Type F

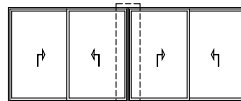

Schema | Type E

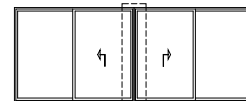

Schema | Type T1

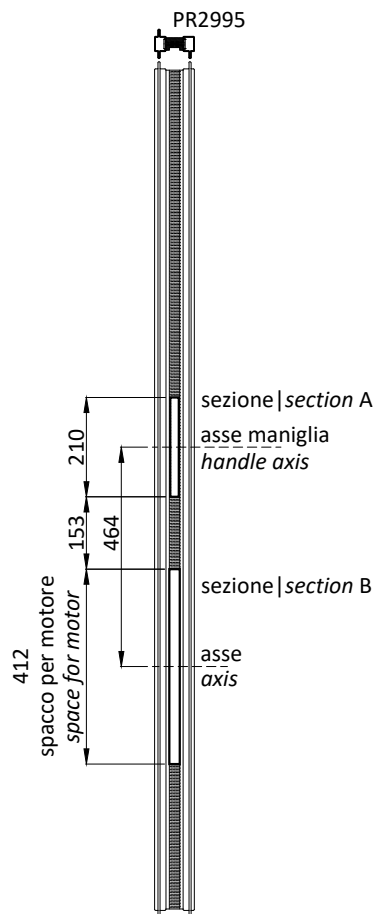
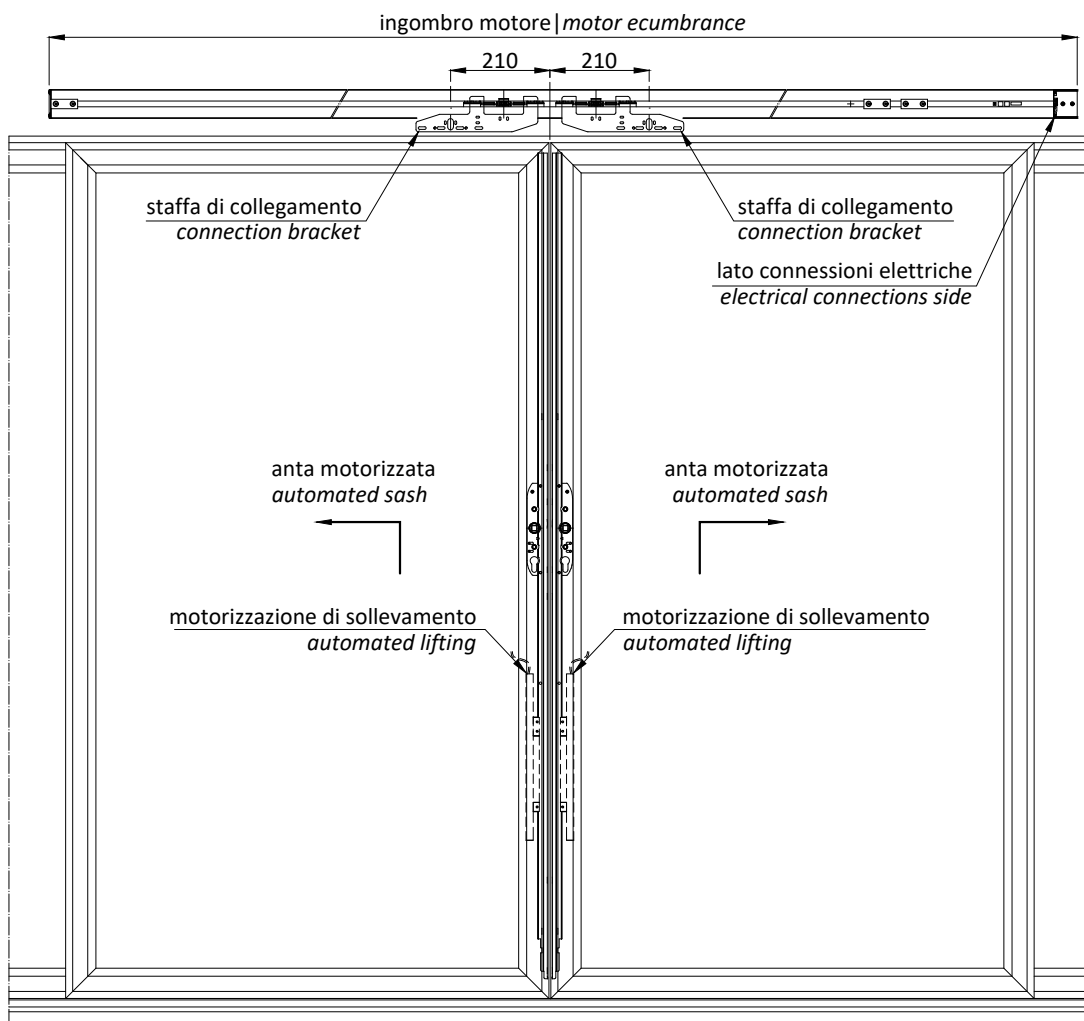
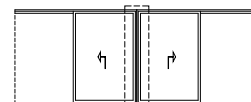

foro per sollevamento manuale  
hole for manual lifting

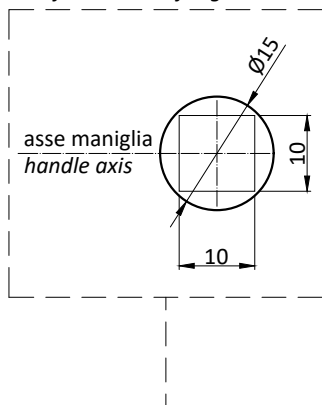

sezione | section A  
cremonese  
cremone

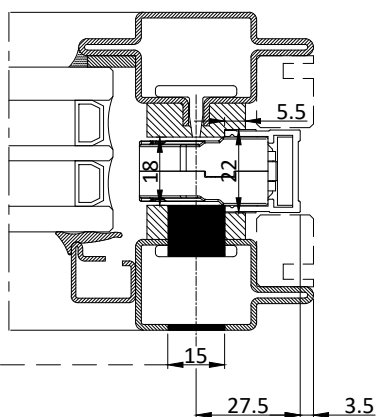

sezione | section B  
motore sollevamento  
automated lifting

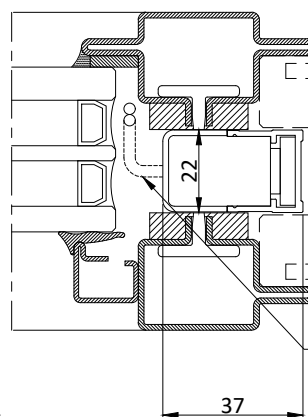

ATTENZIONE  
segnalato con apposito adesivo il foro di  
fissaggio da non utilizzare in quanto  
interferisce con il motore di sollevamento

ATTENTION  
the fixing hole must not be used as it  
interferes with the lifting motor and must  
be marked with a sticker

cavi di alimentazione  
power source wiring

Schema | Type F

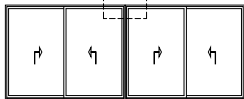

Schema | Type E

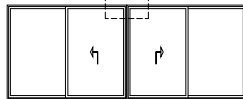

Schema | Type C3

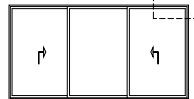

Schema | Type C

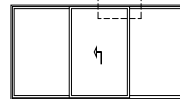

Schema | Type B

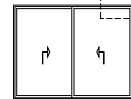

Schema | Type A

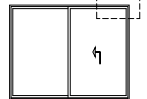

Schema | Type T1

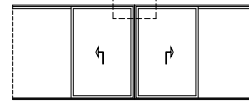

Schema | Type S1

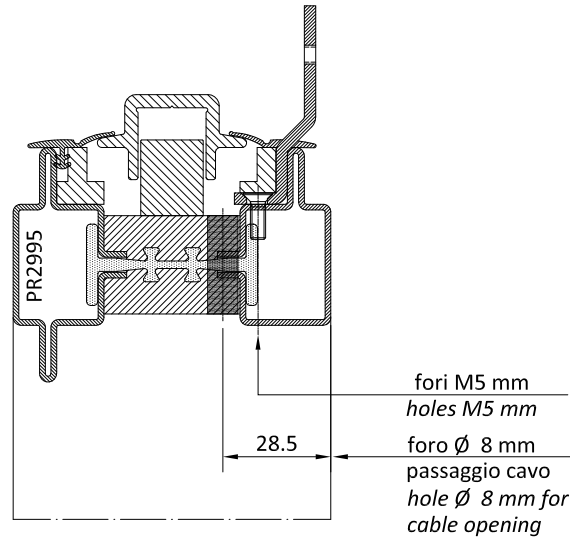
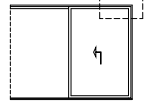

asse staffa | bracket axis 605 (Schema | Type A-B-C-C3-S1)

asse staffa | bracket axis 210 (Schema | Type E-F-T1)

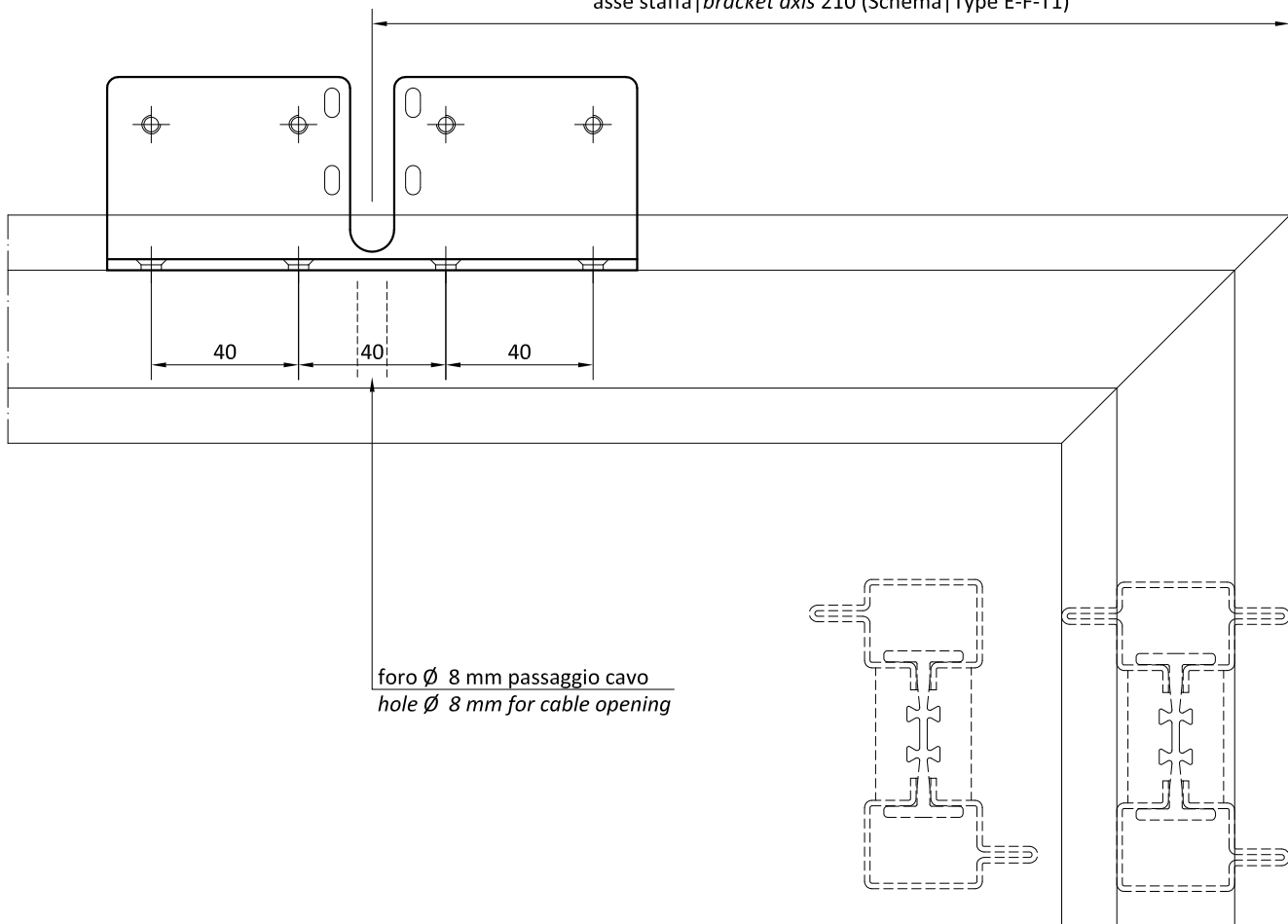

Schema | Type C3



Schema | Type B

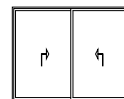

Schema | Type A

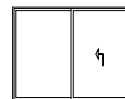

Schema | Type S1

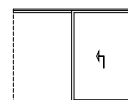

Anta laterale motorizzata  
con punti di fissaggio  
*Motorized lateral sash with  
locking points*

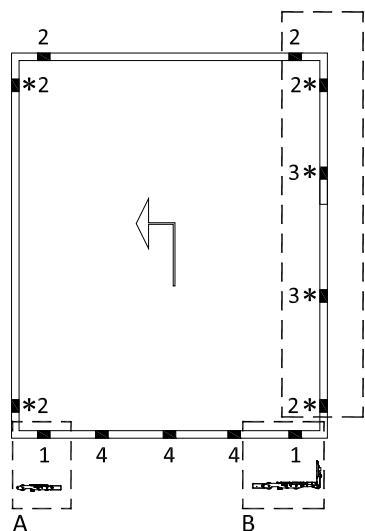

PARTICOLARE "C"  
PARTICULAR "C"

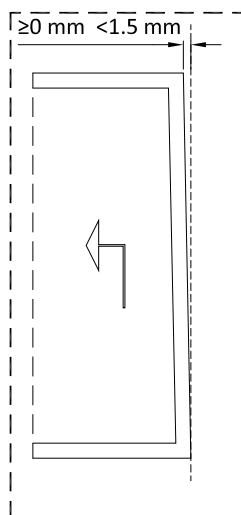

PARTICOLARE "A"  
PARTICULAR "A"

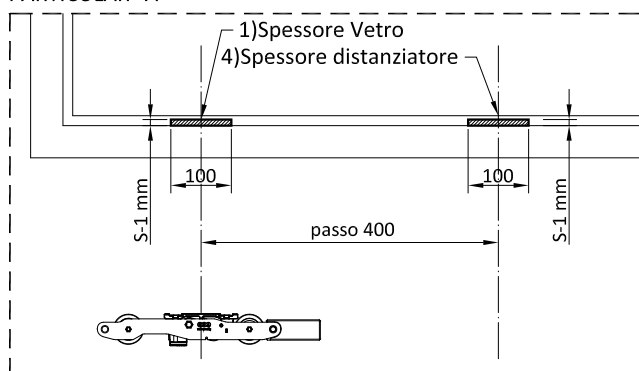

PARTICOLARE "B"  
PARTICULAR "B"

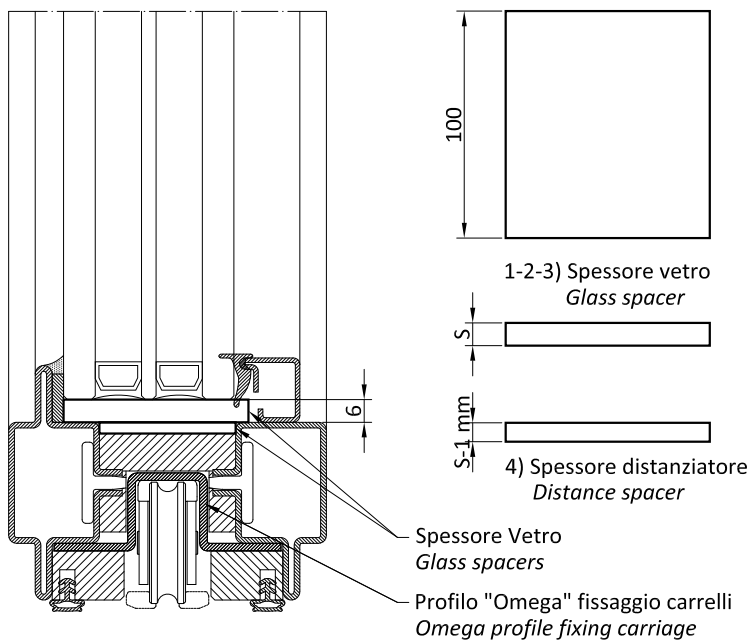
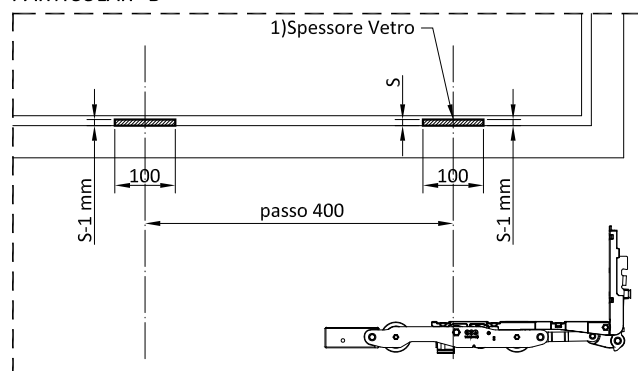

- 1) Spessore portante (allineato ai carrelli dove presenti)
- 2) Spessore distanziatore
- 3) Spessore distanziatore per punti di chiusura
- 4) Spessore distanziatore

- 1) Load-bearing spacer (aligned with carriages if present)
- 2) Distance spacer
- 3) Distance spacer for locking points
- 4) Distance spacer

\* Verticalmente fissare spessore vetro con Silicone

\* Attach glass spacer vertically with Seal

Schema | Type C

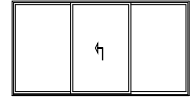

Anta motorizzata senza punti di fissaggio  
Motorized sash without locking points

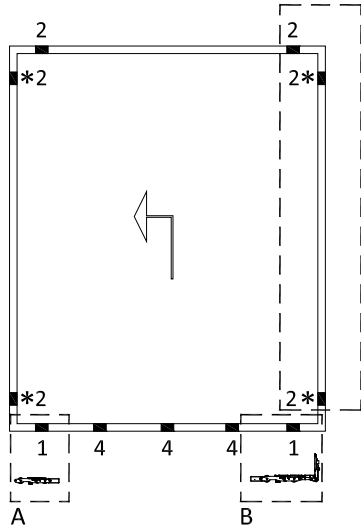

PARTICOLARE "C"  
PARTICULAR "C"

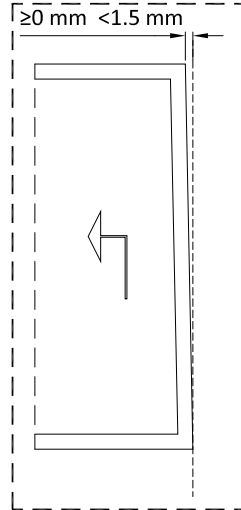

PARTICOLARE "A"  
PARTICULAR "A"

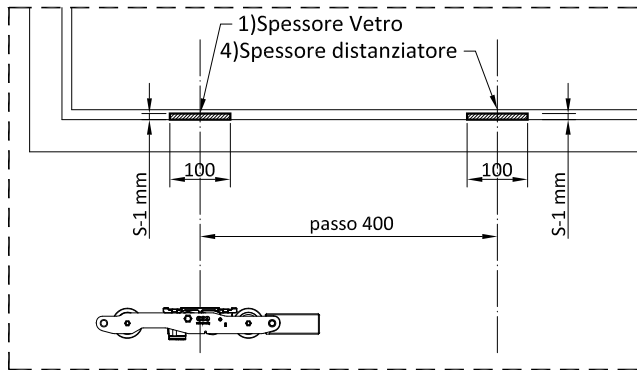

PARTICOLARE "B"  
PARTICULAR "B"

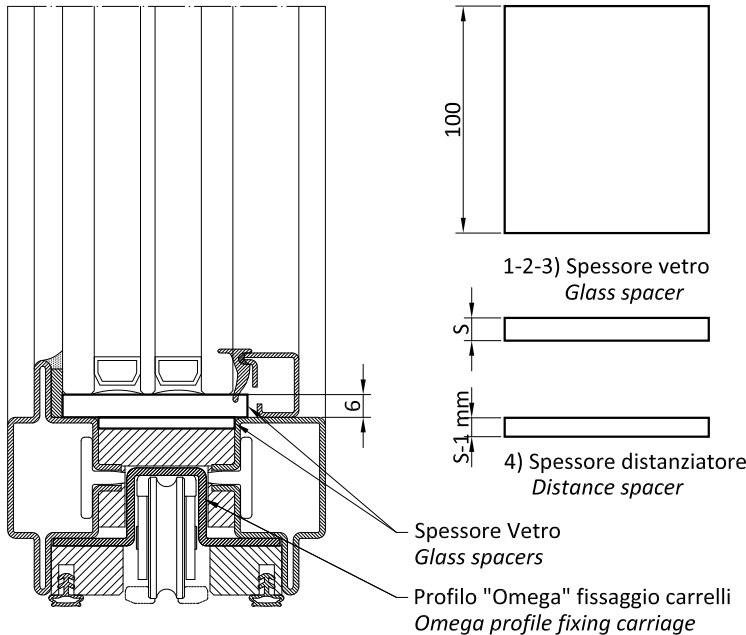
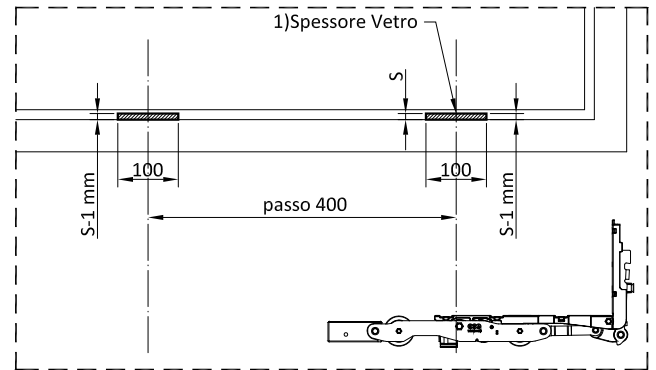

- 1) Spessore portante (allineato ai carrelli dove presenti)
- 2) Spessore distanziatore
- 3) Spessore distanziatore per punti di chiusura
- 4) Spessore distanziatore

- 1) Load-bearing spacer (aligned with carriages if present)
- 2) Distance spacer
- 3) Distance spacer for locking points
- 4) Distance spacer

\* Verticalmente fissare spessore vetro con Silicone

\* Attach glass spacer vertically with Seal



Anta laterale motorizzata  
con punti di fissaggio  
*Motorized lateral sash with  
locking points*

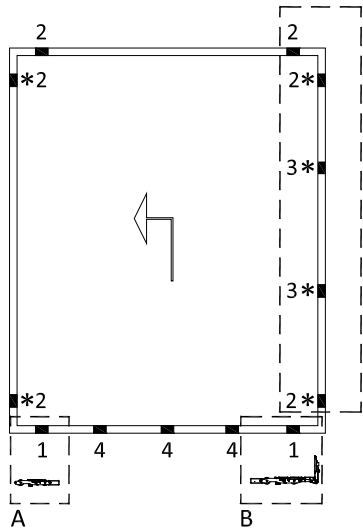

Schema | Type F

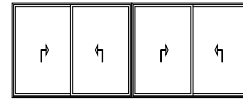

Schema | Type E

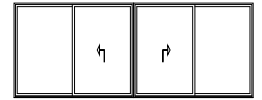

Schema | Type T1

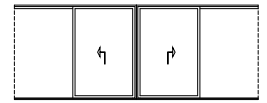

PARTICOLARE "C"  
PARTICULAR "C"

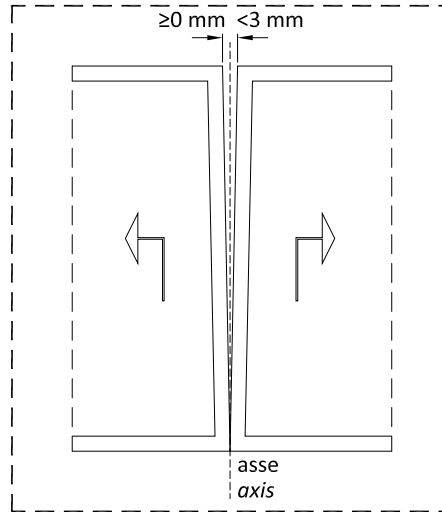

PARTICOLARE "A"  
PARTICULAR "A"

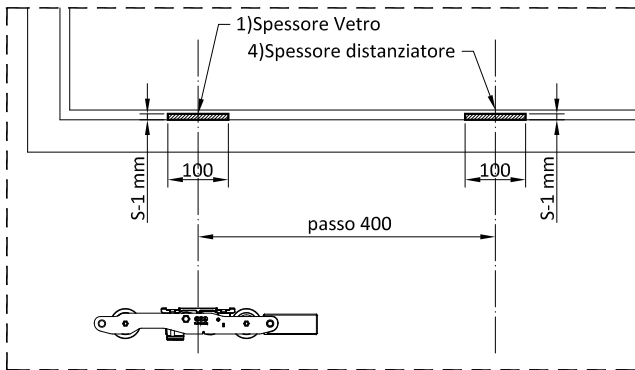

PARTICOLARE "B"  
PARTICULAR "B"

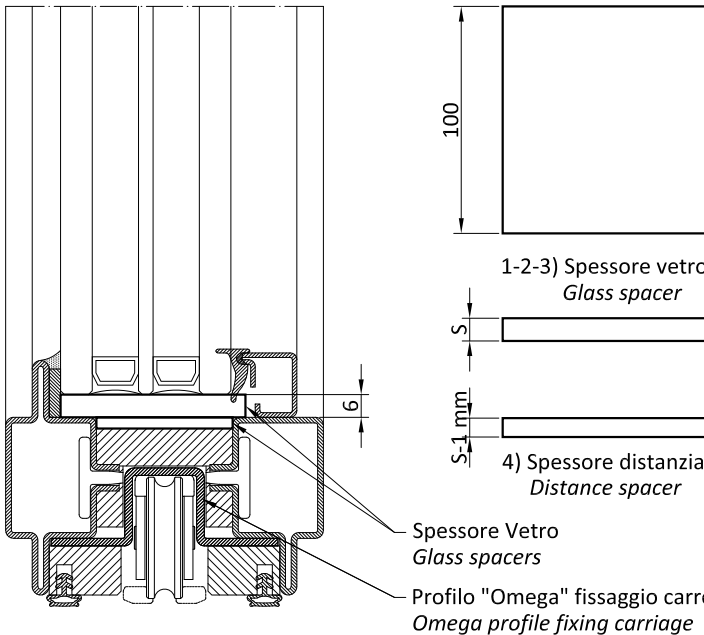
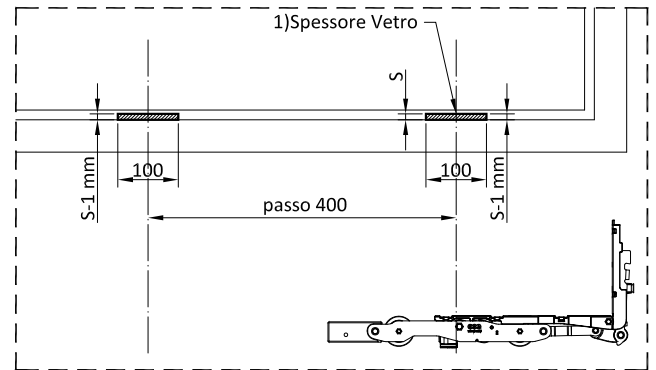

- 1) Spessore portante (allineato ai carrelli dove presenti)
- 2) Spessore distanziatore
- 3) Spessore distanziatore per punti di chiusura
- 4) Spessore distanziatore

- 1) Load-bearing spacer (aligned with carriages if present)
- 2) Distance spacer
- 3) Distance spacer for locking points
- 4) Distance spacer

\* Verticalmente fissare spessore vetro con Silicone

\* Attach glass spacer vertically with Seal

Schema | Type T1

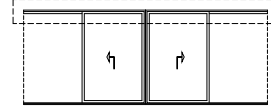

Schema | Type S1

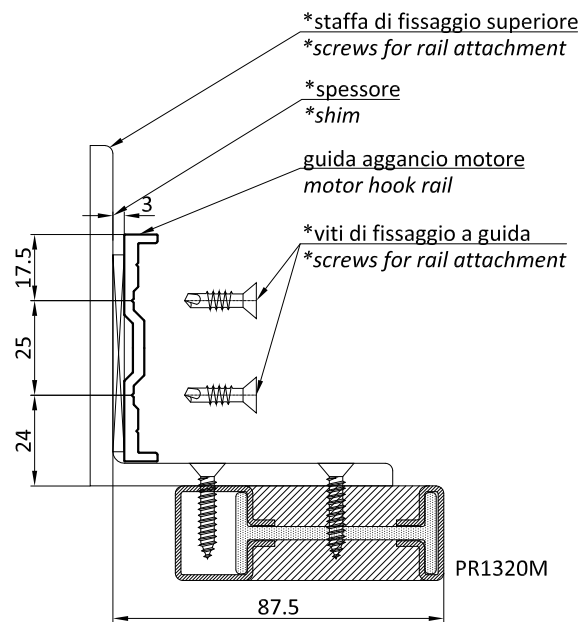
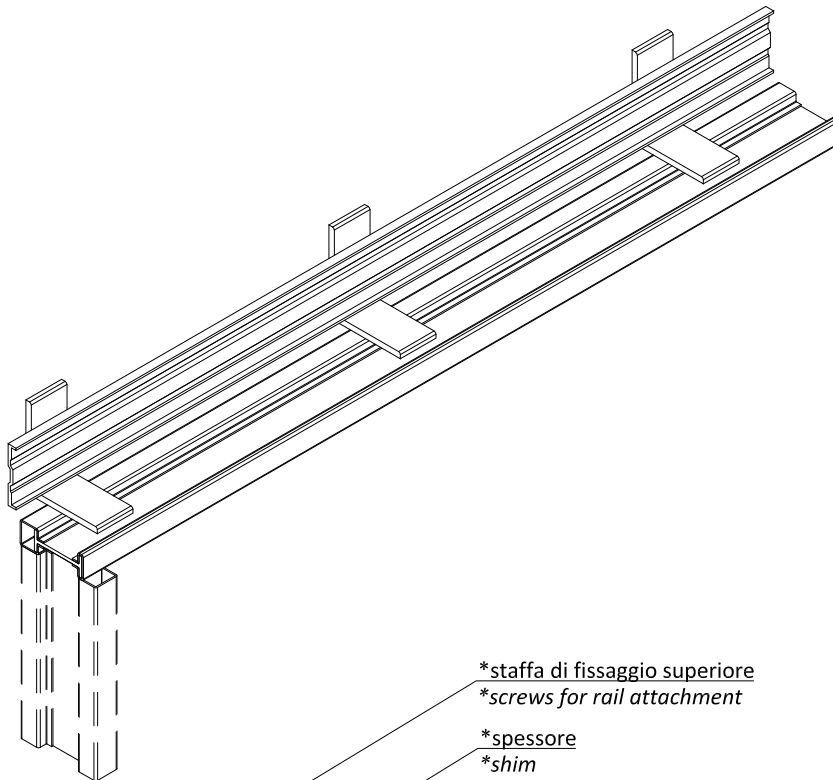
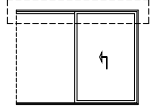

\*non fornito | not supplied

Schema | Type F

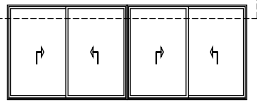

Schema | Type E

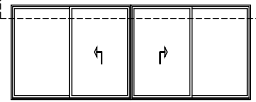

Schema | Type C3

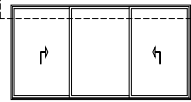

Schema | Type C

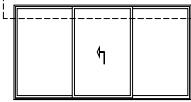

Schema | Type B

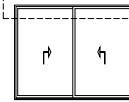

Schema | Type A

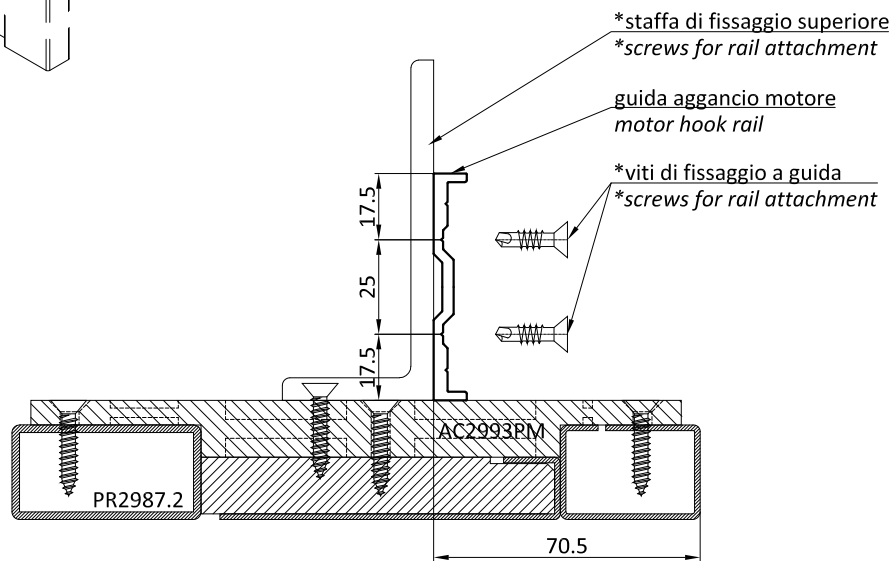
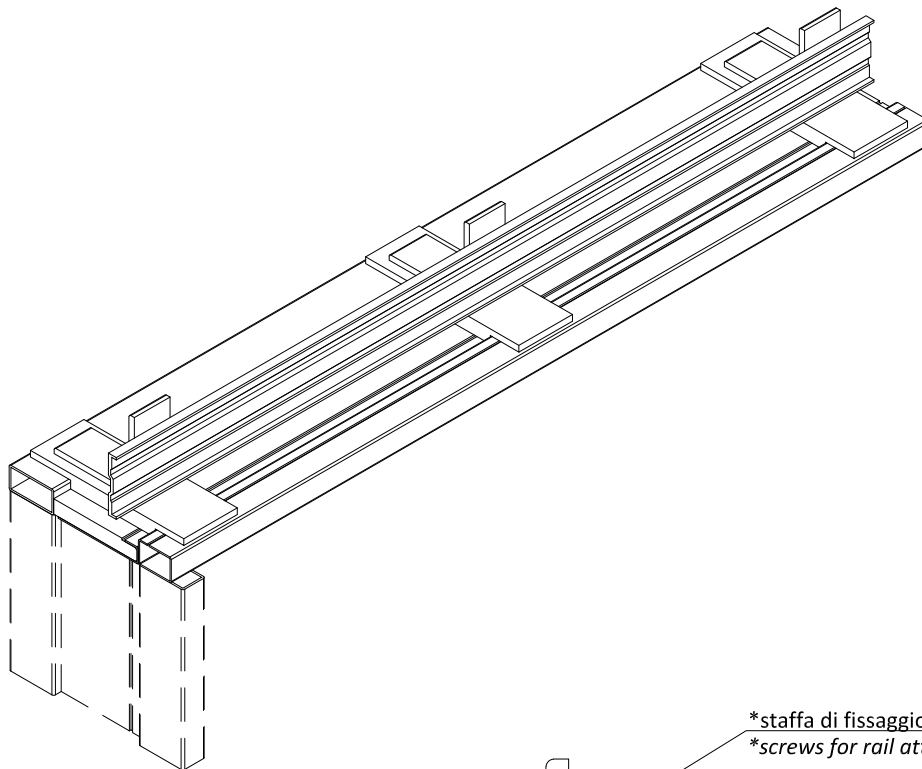
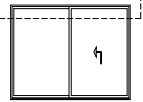

\*non fornito | not supplied

**Generalità**

I sistemi progettati e sviluppati dalla Secco Sistemi sono idonei per la fabbricazione di un'ampia gamma serramenti, vetrate e facciate in metallo. I sistemi sono rivolti ad aziende esperte e professionali nel campo della lavorazione dei metalli e della costruzione di serramenti e facciate, che sono a conoscenza delle normative di riferimento, delle direttive e delle specifiche tecniche del fornitore del sistema, nonché delle fondamentali regole dell'arte per la produzione e installazione di questi manufatti. Tutta la documentazione tecnica fornita costituisce un riferimento per i tecnici qualificati delle aziende al fine di indicare le modalità per la costruzione dei prodotti. In ogni caso i tecnici qualificati devono analizzare criticamente le indicazioni riportate per verificarne la loro adeguatezza per ogni singola commessa in relazione ai carichi, agli stress previsti e alle condizioni di messa in opera, essendo impossibile riportare in questa documentazione tutte le varianti riscontrabili nei progetti reali.

**Tolleranze**

OS2 75 AS L prevede l'accoppiamento tra i telai esterni e le ante apribili con distanza di 4 mm nei giunti laterali e di 3 e 14 mm nei giunti inferiore e superiore. Per garantire il corretto funzionamento degli accessori e delle guarnizioni le lavorazioni devono essere eseguite con particolare attenzione e precisione: si consiglia di mantenere la tolleranza per la dimensione degli elementi apribili compresa tra +0/-1 mm.

**Taglio/Lavorazioni**

I profili OS2 75 AS L in acciaio zincato, acciaio inox e corten possono essere tagliati con le normali troncatrici a disco utilizzate per i tubolari in acciaio, mentre per il taglio dei profili in ottone possono anche essere utilizzate troncatrici per le serie di alluminio. Vista la loro particolare dimensione e forma si consiglia di utilizzare le ganasce di taglio previste dal sistema per assicurare una perfetta stabilità dei profili durante il taglio. La verifica del taglio, sia per la sezione inclinata a 45° che per la sezione verticale a 90°, dovrebbe garantire una tolleranza compresa tra -1°/+1°. Tutte le lavorazioni devono essere eseguite con il rispetto della seguente nota tecnica ed eventuali modifiche concordate con l'ufficio tecnico Secco Sistemi.

**Saldatura**

I profili OS2 75 AS L possono essere saldati con i tradizionali sistemi di saldatura (MIG/MAG, TIG), con un idoneo sistema di lubrificazione/refrigerazione e utilizzando le istruzioni presenti nella presente nota tecnica ed evitando di saldare in prossimità della giunzione a taglio termico. L'eventuale riscaldamento del poliuretano libera sostanze gassose a base di aldeidi e CO: per tale ragione si consiglia di saldare con gli appositi DPI previsti e in zone con sufficiente areazione e in presenza di sistema per l'evacuazione dei fumi. I profili in corten devono essere saldati con apposito filo in corten mentre per i profili in ottone si può utilizzare un filo CuSi3. Si raccomanda di saldare in profondità e senza lasciare fori e porosità nelle aree in contatto, di lisciare e pulire adeguatamente la superficie saldata per garantire una corretta resistenza strutturale all'angolo e permettere una successiva verniciatura senza imperfezioni estetiche visibili (pori e ondulazioni).

**Verniciatura/Brunitura**

I profili OS2 75 AS L sono stati progettati per essere verniciati a polveri in forni con temperature di 180°C per 25 minuti. La zona a taglio termico in poliuretano non è in grado di accogliere con sufficiente adesione le polveri poliesteri e perciò si consiglia di ricoprire tali zone, nelle sole parti destinate ad essere in vista, con apposite pellicole adesive idonee al passaggio in forno. I telai prima della verniciatura o della brunitura devono essere forati come da istruzioni presenti in questa nota tecnica per permettere la fuoriuscita dei liquidi utilizzati durante il pretrattamento delle superfici. All'uscita del forno di polimerizzazione della polvere i telai vanno rimossi accuratamente e adagiati in posizione piana sino al loro completo raffreddamento. Si consiglia di seguire il ciclo di pretrattamenti e verniciatura presente nella documentazione Secco Sistemi.

**Vetrazione**

Il sistema di fissaggio del vetro prevede l'utilizzo di fermavetri agganciati all'interno tramite clips interne e mandati in pressione con l'incastro dell'apposita guarnizione interna; all'esterno è previsto l'utilizzo di una guarnizione perimetrale continua giuntata e sigillata in un angolo superiore o di una guarnizione butilica di fondo giunto e un cordolo di silicone applicato secondo le prescrizioni tecniche del fornitore del prodotto. Per il corretto funzionamento del sistema si suggerisce di verificare la perfetta compressione delle guarnizioni interne del fermavetro.

**Installazione**

La corretta installazione deve garantire il mantenimento delle performance dichiarate nella marcatura CE e testate in laboratorio. Si consiglia di progettare un corretto numero di fissaggi in relazione al tipo di controtelaio/muratura esistente e alle dimensioni degli elementi da installare. Al termine dell'installazione si verifichi il corretto funzionamento del serramento (facilità di apertura/chiusura, stabilità dell'anta aperta a riposo, etc.), il rispetto delle distanze tra ante apribili e telai fissi, il regolare posizionamento delle guarnizioni e delle sigillature e la mancanza di difetti estetici sulle superfici del telaio e del vetro.

**General information**

The systems designed and developed by Secco Sistemi are suitable for the manufacturing of a wide range of doors, windows and shutters, as well as faces or facades in metal. The systems are designed for professional and expert companies in the metal-working sector and that of construction of doors, windows, shutters and facades. These companies are well aware of the specific regulations and the directions and technical specifications of the system supplier, and also the fundamental rules of the art of manufacturing and installing these products. All the technical documentation provided furnishes a source of reference for the qualified technicians of the companies, giving indications as to how the products should be constructed. These qualified experts must critically analyse the indications to verify their adequacy for each single order in terms of load, stress and conditions of installation, particularly as this documentation cannot provide for all the different variations that may be found in projects.

**Tolerance**

OS2 75 AS L is made by coupling external frames with the opening leaves with a distance of 4 mm in lateral joint and 3 mm or 14 mm in the lower and upper joint. To ensure the correct functioning of hardware and gaskets, tooling must be performed with great care and precision. It is advised to keep the tolerance between +0/-1 mm for opening elements.

**Cut / Processing**

OS2 75 AS L profiles in galvanized steel, stainless steel and corten steel can be cut with normal saws, like those used for steel pipes. OS2 75 AS L profiles in brass can be cut with saws used for aluminium. Given their dimension and size, it is recommended to use the cutting jaws advised to ensure perfect stability during the cutting procedure. In order to verify the correctness of the cut, the tolerance of both the 45° and the 90° sections must be between -1°/+1°. All Tooling must be performed in line with this technical note and any variations agreed with Secco Sistemi's Technical Department.

**Welding**

OS2 75 AS L profiles can be welded with the traditional systems (MIG/MAG, TIG), with an appropriate lubricating/cooling system and according to the instructions as per this technical note. Avoid welding near the thermal break joint. Heating any polyurethane items releases gaseous substances containing aldehydes and CO. For this reason, it is recommended to weld with the special Personal Protective Equipment suggested and in areas with sufficient ventilation and fume-disposing systems. The corten profiles must be welded with special corten wire, while for profiles in brass a CuSi3 wire can be used. It is recommended to weld in depth, to avoid leaving any holes or porosity on the surfaces and to smooth and clean the welded surface thoroughly. This is to guarantee a proper structural resistance at the corner and to allow for later painting without any visible imperfections (pores and ripples).

**Painting/Burnishing**

OS2 75 AS L profiles have been designed to be painted with the powder coating technique in industrial ovens at temperatures of 180°C for 25 minutes. The thermal break area is not designed to absorb polyester powders and therefore it's advised to cover the visible areas with appropriate industrial-oven-resistant adhesive films (SA1024 and SA1033). Holes must be drilled in the frames (as per instructions in these technical specifications) before painting or burnishing in order to allow drainage of any liquid used as a pre-treatment of the surfaces. Once out of the oven, the frames must be accurately removed and laid in a horizontal position until complete cooled.

It is advised to follow pre-treatment and painting cycles as outlined in the Secco Sistemi documentation.

**Glass application**

Glass needs to be secured internally and externally. Internally, glazing beads must be used together with clips then secured by pressure with the appropriate gasket; externally a continuous perimetrical gasket should be applied, jointed and sealed in a top corner or a butyl seal and a thread of silicone that must be applied according to the product supplier's technical specifications. In order to ensure the correct functioning of the system, it is recommended to verify the proper pressurization of the internal glazing bead gaskets.

**Installation**

Proper installation must guarantee that the performances declared in the EC marking and verified in the lab will remain constant. It is advised to arrange a correct series of set ups with reference to the existing type of subframe/brickwork and to the dimensions of the elements to install. Once installation is completed, the proper functioning of the window/door (easiness of opening/closing, stability of the open leaf, etc.), should be tested as well as the correctness of joints and overlapping areas between opening leaves and fixed frames, the proper positioning of gaskets and seals, the drainage of frames with weep system and the absence of any aesthetic defects on the frame and glass surfaces.

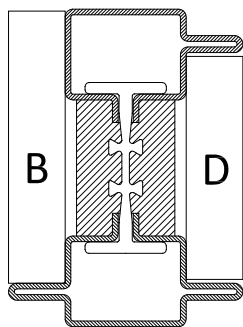

PR2995

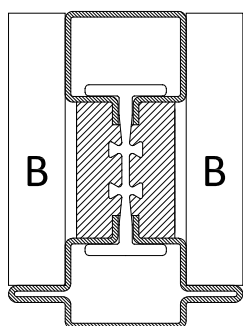

PR2992

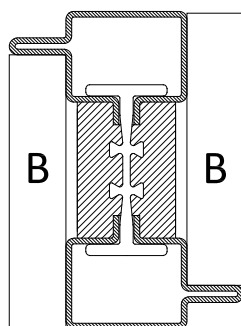

PR2993

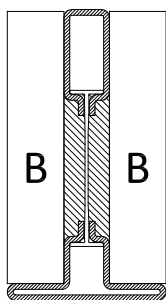

PR2952

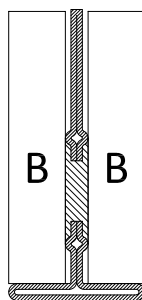

PR2954

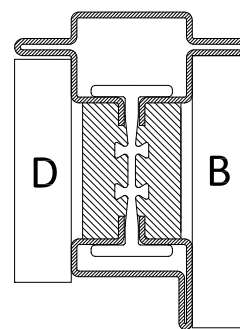

PR2992C

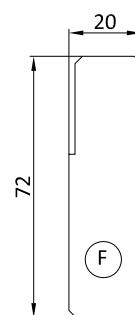
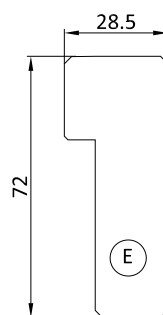
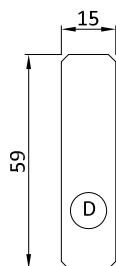
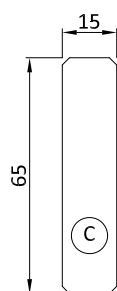
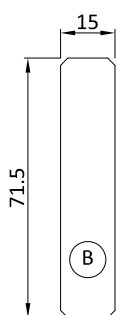
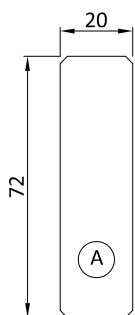

## telaio | frame

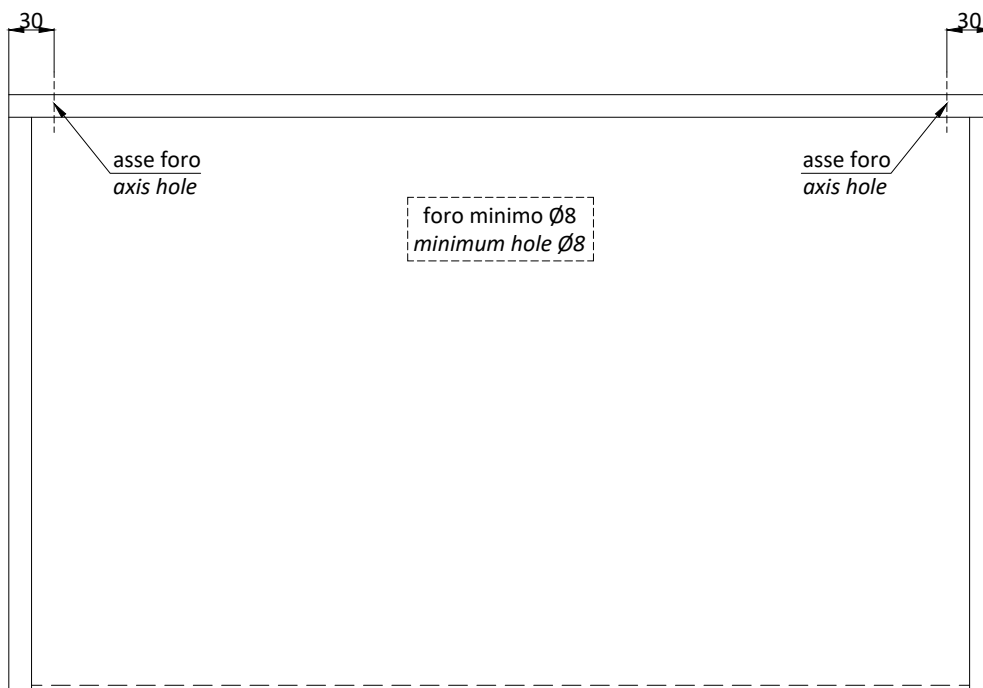

N.B. dimensioni orientamento telai indicative - da verificare con l'impianto di verniciatura/brunitura scelto

N.B. frame dimensions are indicative - they have to be checked with the powder painting / burnishing plant

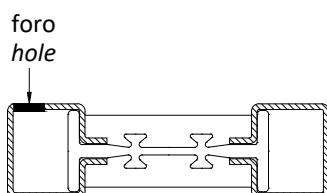

PR1320



PR2986

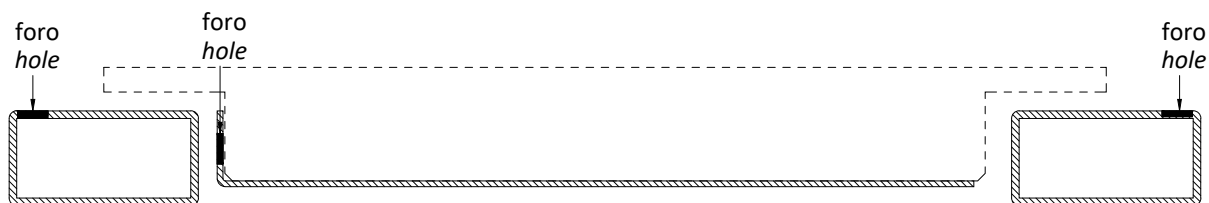

PR2986.3 - 2986L.3 - 2986S.3

anta | sash

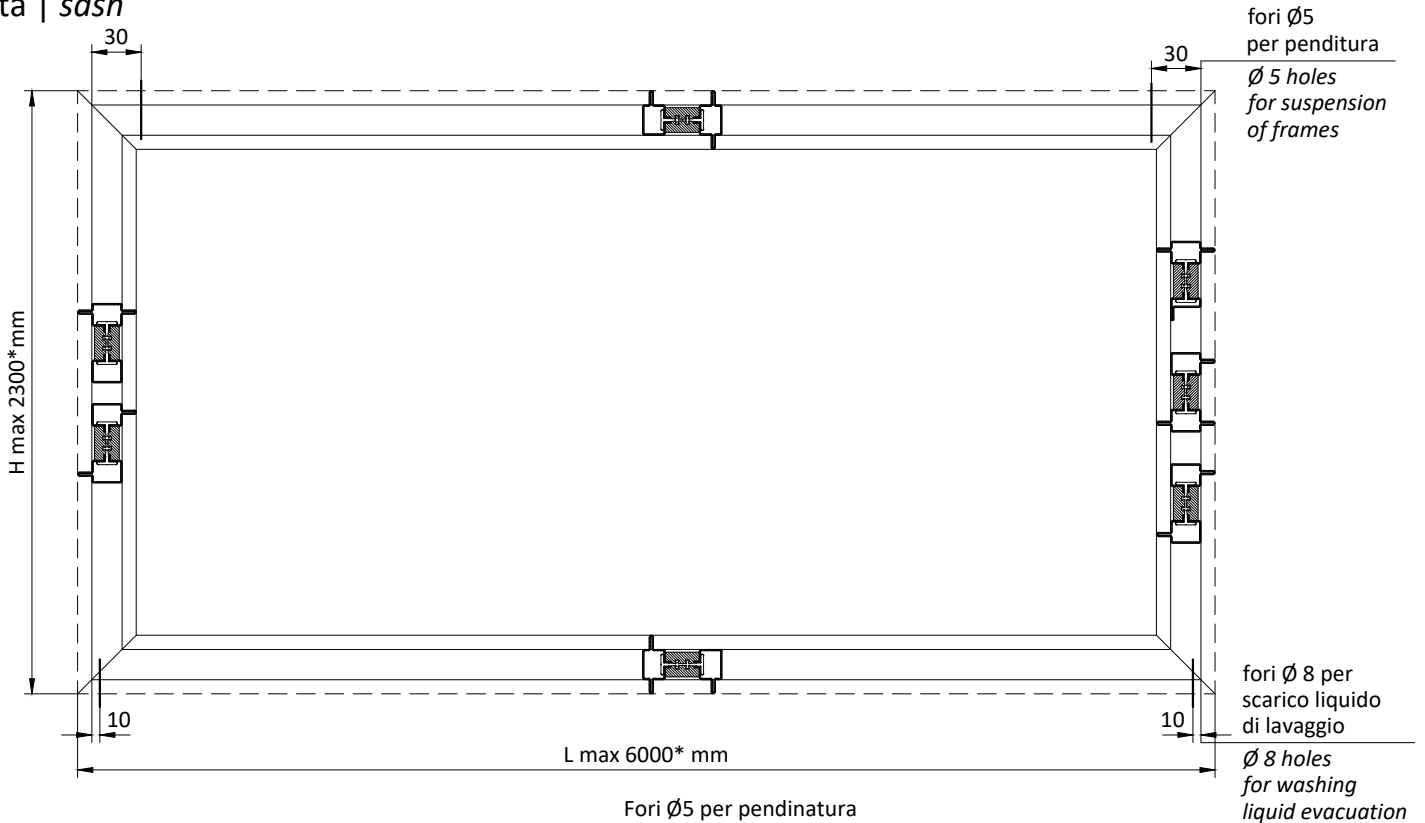

Fori Ø5 per pendinatura  
telai con peso inferiore a 40 kg  
Ø 5 holes for suspension  
of frames not heavier than 40 kg

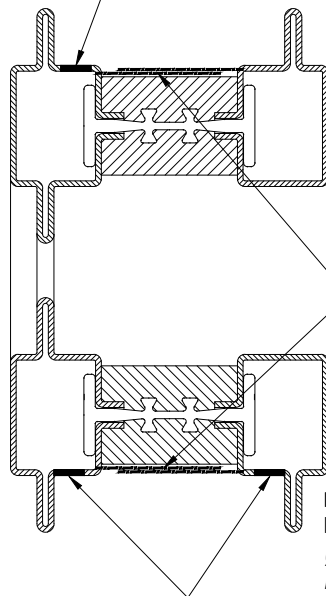

**SOLO PER VERNICIATURA**  
Nastro adesivo protettivo da  
25 mm resistente alle alte  
temperature (220-230°)  
**ONLY FOR PAINTING**  
Protective 25 mm tape resistant  
to high temperatures (220-230°)

Fori Ø 8 per lo scarico del  
liquido di lavaggio  
Ø 8 holes for washing  
liquid evacuation

**SOLO PER BRUNITURA**

Preparare il profilo da trattare pulendolo con una paglietta tipo Scotch Brite in modo da ottenere superfici lucide e uniformi.  
Movimentare il prodotto carteggiato con cautela per non danneggiare la finitura superficiale e non toccare a mani nude il profilo per ottenere un trattamento di brunitura uniforme.

**ONLY FOR BURNISHING**

Prepare the profile grinding it with a Scotch Brite wool in order to obtain uniform surfaces.  
Ease profiles carefully to avoid any damages on the surface as well as do not touch it with hands to allow an uniform burnishing.

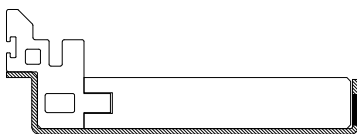

Fori Ø5 per pendinatura  
Ø 5 holes for suspension

\* Dimensioni massime disponibili nell'impianto di Secco Sistemi  
\* Maximum available size in the Secco Sistemi plant



**Troncatrice**caratteristiche minime della macchina

- Potenza: 1.8 – 2.5 kW;
- Possibilità di taglio a 45° nei due sensi e a 90°;
- Velocità di taglio ideali: 15-30 giri/min per acciaio inox;  
60-90 giri/min per acciaio zincato e corten,  
90 giri/min o superiori per bronzo (OT/67);
- Capacità di taglio: 150 x 80 mm a 90°;  
100 mm taglio a 45°.

caratteristiche della lama

- Lama da 350 mm con spessore 2.5 mm;
- N° denti: - 300 per tagli a 45°;  
- 350 per tagli a 90°;
- Materiale: HSS (verificare materiali di commercio con finiture che migliorano la durata delle lame).

NB: è possibile tagliare la lega OT/67 con le stesse macchine dell'alluminio.

**Pantografo**caratteristiche minime della macchina

- Mandrino con velocità regolabile 2000-11000 giri/min (per un corretta lavorazione su acciaio inox è necessario operare a n° ridotto di giri < 4000);
- Struttura in ghisa adatta al taglio acciaio;
- Testata pesante per limitare le vibrazioni;
- Chiusura del profilo da lavorare con morse.

caratteristiche minime delle frese

- Materiale: HSS (verificare materiali di commercio con finiture che migliorano la durata delle frese);
- Frese a 4 denti;
- Frese con diametro 5 mm per le lavorazioni di scasso.

**Forature**montaggio componenti di chiusura e movimentazione sui profilati in acciaio inox

- Forare con punte da trapano HSS del diametro indicato sulla corrispondente tavola tecnica;
- Maschiare il foro con vite autofilettante zincocromata avente diametro corrispondente alla vite inox fornita nel kit con l'articolo da montare;
- Posizionamento e fissaggio definitivo dell'articolo con le viti inox in dotazione.

fresatura di cave e asole sui profili inox

- Adoperare macchine (pantografi o fresatrici) adeguate alle lavorazioni dell'acciaio;
- Regolazione del numero di giri max (3000 giri/1');
- Impiego di frese di diametro massimo di 8mm a 4 pale in acciaio HSS;
- Abbondare con la lubrificazione, concentrata sull'utensile;
- Ridurre l'avanzamento fino ad accertare un taglio il più regolare possibile;
- È normale un'usura accelerata dell'utensile.

**Cutter**Minimum requirements for the use of the machine

- Power: 1.8 – 2.5 kW;
- Possibility of cutting at 45° in both directions and at 90°;
- Ideal cutting speed: 15-30 rmp for stainless steel;  
60-90 rmp for galvanised and corten steel;  
90 rmp or higher for bronze (OT/67);
- Cutting capability: 150 x 80 mm at 90°;  
100 mm cut at 45°.

Blade specifications

- 350 mm blade with a 2.5 mm thickness;
- Number of teeth: 300 for 45° cut;  
350 for 90° cut;
- Material: HSS (please verify availability of longer lasting material on the market).

Note: OT/67 alloy can be cut with machines made for aluminum.

**Phantograph**Minimum requirements for the use of the machine

- Mandrel with a 2000-11000 rmp adjustable speed (for a proper stainless steel processing a slower speed is required i.e.<4000 rpm);
- Machine should be made of cast iron suitable for steel cutting;
- Heavy head in order to limit vibrations;
- Secure the profile to be processed in jaws.

Minimum requirements for the use of a milling machine

- Material: HSS (please verify availability of longer lasting material on the market);
- Use a 4-tooth milling machine;
- Use a milling machine with a 5-mm diameter for groove processing.

**Drilling**How to mount closing and moving components on a stainless steel profile

- Use a HSS drill. The diameter of the drill is indicated in the technical note;
- Thread the hole with self-threading zinc-plated screws with the same diameter as the stainless steel screw provided with the kit;
- Position and secure the item with the stainless steel screws provided.

Milling slots and loops in the profiles

- Use machines designed for steel processing (phantographs or milling machines);
- Max rpm setting (3000 rpm);
- Use milling machines with a diameter no bigger than 8 mm and with 4 HSS steel blades;
- Exceed with lubrication, mainly on the machine;
- Processed slowly until the milling is as clean as possible;
- Expect a fast wearing of the machine.

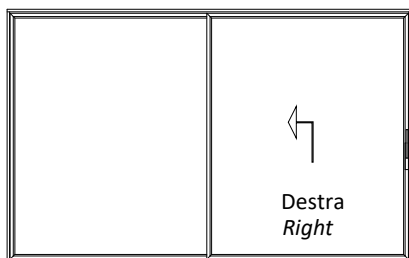
Schema | Type A 1 anta scorrevole ed 1 anta fissa  
1 sliding and 1 fixed sash

Codice   Code	Descrizione   Description
AG2996A	Kit movimentazione e tenuta 1 anta apribile 1 leaf handling and sealing kit
ACV078	Maniglione singolo Single handle
ACV078Y	Maniglione singolo con cilindro Single handle with hole cilinder
ACV178Y	Maniglione doppio con cilindro Double handle with hole cilinder

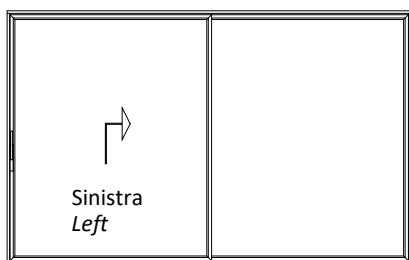
Schema | Type A 1 anta scorrevole ed 1 anta fissa  
1 sliding and 1 fixed sash

Codice   Code	Descrizione   Description
AG2997A	Kit movimentazione e tenuta 1 anta apribile 1 leaf handling and sealing kit
ACV078	Maniglione singolo Single handle
ACV078Y	Maniglione singolo con cilindro Single handle with hole cilinder
ACV178Y	Maniglione doppio con cilindro Double handle with hole cilinder

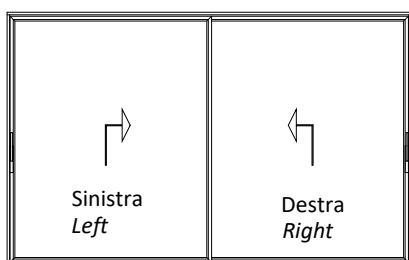
Schema | Type B 2 ante scorrevoli  
2 sliding sashes

Codice   Code	Descrizione   Description
AG2996B - AG2997B	Kit movimentazione e tenuta 2 ante apribili 2 leaf handling and sealing kit
ACV078	Maniglione singolo Single handle
ACV078Y	Maniglione singolo con cilindro Single handle with hole cilinder
ACV178Y	Maniglione doppio con cilindro Double handle with hole cilinder

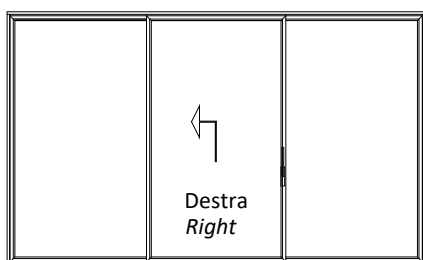
Schema | Type C serie di ante fisse e ante scorrevoli  
series of fixed and sliding sashes

Codice   Code	Descrizione   Description
AG2996C	Kit movimentazione e tenuta 1 anta apribile 1 leaf handling and sealing kit
ACV078	Maniglione singolo Single handle
ACV078Y	Maniglione singolo con cilindro Single handle with hole cilinder
ACV178Y	Maniglione doppio con cilindro Double handle with hole cilinder

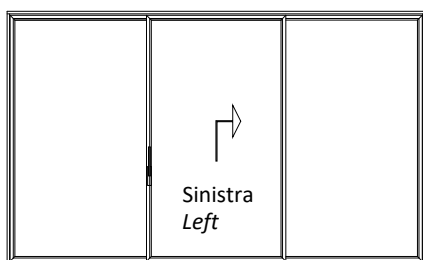
Schema | Type C serie di ante fisse e ante scorrevoli  
series of fixed and sliding sashes

Codice   Code	Descrizione   Description
AG2997C	Kit movimentazione e tenuta 1 anta apribile 1 leaf handling and sealing kit
ACV078	Maniglione singolo Single handle
ACV078Y	Maniglione singolo con cilindro Single handle with hole cilinder
ACV178Y	Maniglione doppio con cilindro Double handle with hole cilinder

Schema | Type E 2 ante scorrevoli e 2 ante fisse  
2 sliding and 2 fixed sashes

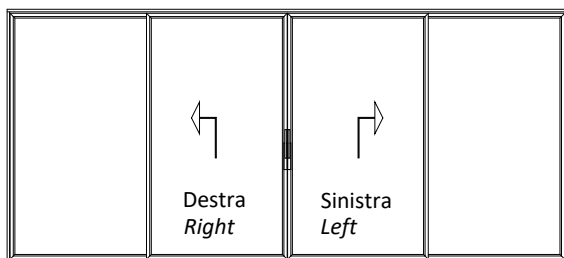

Codice   Code	Descrizione   Description
AG2996E	Kit movimentazione e tenuta 2 ante apribili 2 leaf handling and sealing kit
ACV078	Maniglione singolo Single handle
ACV078Y	Maniglione singolo con cilindro Single handle with hole cilinder
ACV178Y	Maniglione doppio con cilindro Double handle with hole cilinder

Schema | Type F 4 ante scorrevoli  
4 sliding sashes

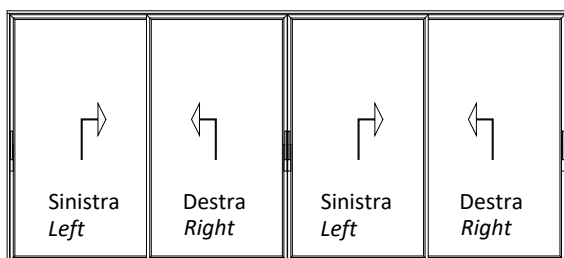

Codice   Code	Descrizione   Description
AG2996F	Kit movimentazione e tenuta 4 ante apribili 4 leaf handling and sealing kit
ACV078	Maniglione singolo Single handle
ACV078Y	Maniglione singolo con cilindro Single handle with hole cilinder
ACV178Y	Maniglione doppio con cilindro Double handle with hole cilinder

Schema | Type A3 2 ante scorrevoli ed 1 anta fissa  
2 sliding and 1 fixed sash

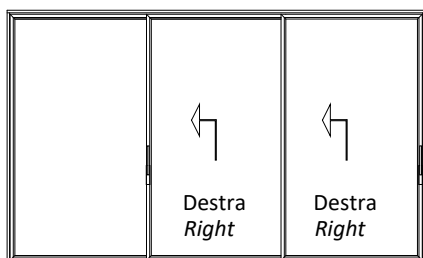

Codice   Code	Descrizione   Description
AG2996A3	Kit movimentazione e tenuta 2 ante apribili 2 leaf handling and sealing kit
ACV078	Maniglione singolo Single handle
ACV078Y	Maniglione singolo con cilindro Single handle with hole cilinder
ACV178Y	Maniglione doppio con cilindro Double handle with hole cilinder

Schema | Type A3 2 ante scorrevoli ed 1 anta fissa  
2 sliding and 1 fixed sash

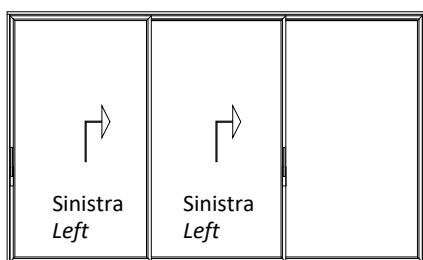

Codice   Code	Descrizione   Description
AG2997A3	Kit movimentazione e tenuta 2 ante apribili 2 leaf handling and sealing kit
ACV078	Maniglione singolo Single handle
ACV078Y	Maniglione singolo con cilindro Single handle with hole cilinder
ACV178Y	Maniglione doppio con cilindro Double handle with hole cilinder

Schema | Type B3 3 ante scorrevoli  
3 sliding sashes

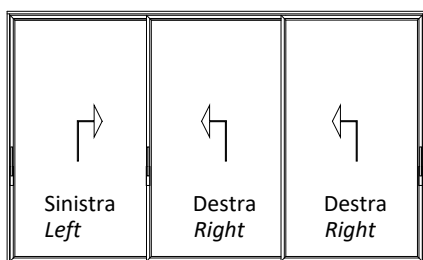

Codice   Code	Descrizione   Description
AG2996B3	Kit movimentazione e tenuta 3 ante apribili 3 leaf handling and sealing kit
ACV078	Maniglione singolo Single handle
ACV078Y	Maniglione singolo con cilindro Single handle with hole cilinder
ACV178Y	Maniglione doppio con cilindro Double handle with hole cilinder

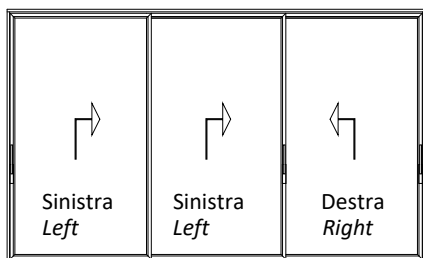
Schema | Type B3 3 ante scorrevoli  
3 sliding sashes

Codice   Code	Descrizione   Description
AG2997B3	Kit movimentazione e tenuta 3 ante apribili 3 leaf handling and sealing kit
ACV078	Maniglione singolo Single handle
ACV078Y	Maniglione singolo con cilindro Single handle with hole cilinder
ACV178Y	Maniglione doppio con cilindro Double handle with hole cilinder

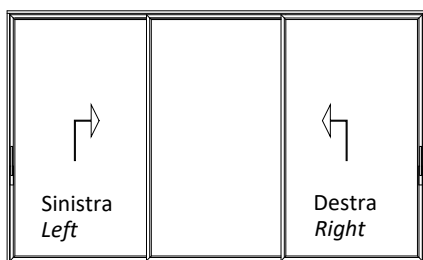
Schema | Type C3 2 ante scorrevoli ed 1 anta fissa  
2 sliding and 1 fixed sash

Codice   Code	Descrizione   Description
AG2996C3-AG2997C3	Kit movimentazione e tenuta 2 ante apribili 2 leaf handling and sealing kit
ACV078	Maniglione singolo Single handle
ACV078Y	Maniglione singolo con cilindro Single handle with hole cilinder
ACV178Y	Maniglione doppio con cilindro Double handle with hole cilinder

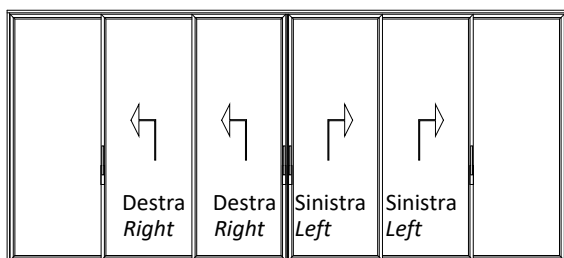
Schema | Type E3 4 ante scorrevoli ed 2 ante fisse  
4 sliding and 2 fixed sashes

Codice   Code	Descrizione   Description
AG2996E3	Kit movimentazione e tenuta 4 ante apribili 4 leaf handling and sealing kit
ACV078	Maniglione singolo Single handle
ACV078Y	Maniglione singolo con cilindro Single handle with hole cilinder
ACV178Y	Maniglione doppio con cilindro Double handle with hole cilinder

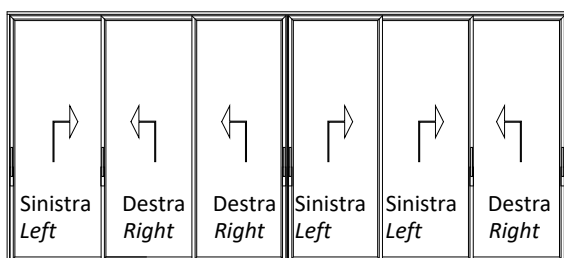
Schema | Type F3 6 ante scorrevoli  
6 sliding sashes

Codice   Code	Descrizione   Description
AG2996F3	Kit movimentazione e tenuta 6 ante apribili 6 leaf handling and sealing kit
ACV078	Maniglione singolo Single handle
ACV078Y	Maniglione singolo con cilindro Single handle with hole cilinder
ACV178Y	Maniglione doppio con cilindro Double handle with hole cilinder

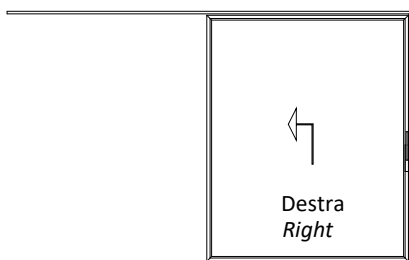
Schema | Type S1 1 anta scorrevole a scomparsa  
1 sliding sash into the wall

Codice   Code	Descrizione   Description
AG2996S1	Kit movimentazione e tenuta 1 anta apribile 1 leaf handling and sealing kit
ACV078	Maniglione singolo Single handle
ACV078Y	Maniglione singolo con cilindro Single handle with hole cilinder
ACV178Y	Maniglione doppio con cilindro Double handle with hole cilinder

Schema | Type S1 1 anta scorrevole a scomparsa  
1 sliding sash into the wall

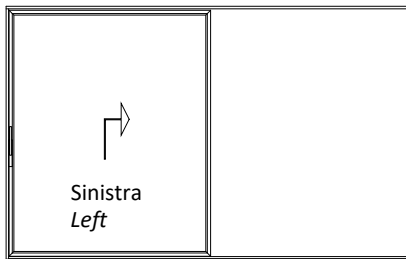

Codice   Code	Descrizione   Description
AG2997S1	Kit movimentazione e tenuta 1 anta apribile 1 leaf handling and sealing kit
ACV078	Maniglione singolo Single handle
ACV078Y	Maniglione singolo con cilindro Single handle with hole cilinder
ACV178Y	Maniglione doppio con cilindro Double handle with hole cilinder

Schema | Type T1 2 ante scorrevoli coassiali a scomparsa  
2 coaxial sliding sashes into the wall

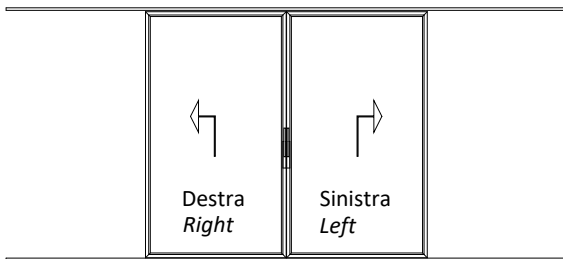

Codice   Code	Descrizione   Description
AG2996T1	Kit movimentazione e tenuta 2 ante apribili 2 leaf handling and sealing kit
ACV078	Maniglione singolo Single handle
ACV078Y	Maniglione singolo con cilindro Single handle with hole cilinder
ACV178Y	Maniglione doppio con cilindro Double handle with hole cilinder

Schema | Type S2 2 ante scorrevoli a scomparsa  
2 sliding sash into the wall

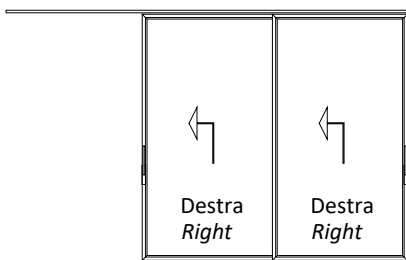

Codice   Code	Descrizione   Description
AG2996S2	Kit movimentazione e tenuta 2 ante apribili 2 leaf handling and sealing kit
ACV078	Maniglione singolo Single handle
ACV078Y	Maniglione singolo con cilindro Single handle with hole cilinder
ACV178Y	Maniglione doppio con cilindro Double handle with hole cilinder

Schema | Type S2 2 ante scorrevoli a scomparsa  
2 sliding sash into the wall

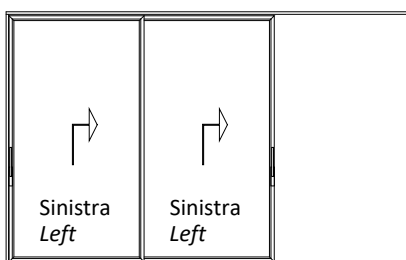

Codice   Code	Descrizione   Description
AG2997S2	Kit movimentazione e tenuta 2 ante apribili 2 leaf handling and sealing kit
ACV078	Maniglione singolo Single handle
ACV078Y	Maniglione singolo con cilindro Single handle with hole cilinder
ACV178Y	Maniglione doppio con cilindro Double handle with hole cilinder

Schema | Type T2 4 ante scorrevoli a scomparsa  
4 sliding sash into the wall

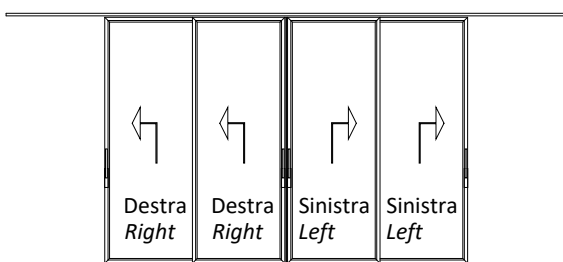

Codice   Code	Descrizione   Description
AG2996T2	Kit movimentazione e tenuta 4 ante apribili 4 leaf handling and sealing kit
ACV078	Maniglione singolo Single handle
ACV078Y	Maniglione singolo con cilindro Single handle with hole cilinder
ACV178Y	Maniglione doppio con cilindro Double handle with hole cilinder

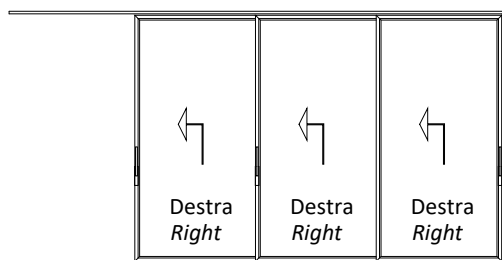
Schema | Type S3 3 ante scorrevoli a scomparsa  
3 sliding sash into the wall

Codice   Code	Descrizione   Description
AG2996S3	Kit movimentazione e tenuta 3 ante apribili 3 leaf handling and sealing kit
ACV078	Maniglione singolo Single handle
ACV078Y	Maniglione singolo con cilindro Single handle with hole cilinder
ACV178Y	Maniglione doppio con cilindro Double handle with hole cilinder

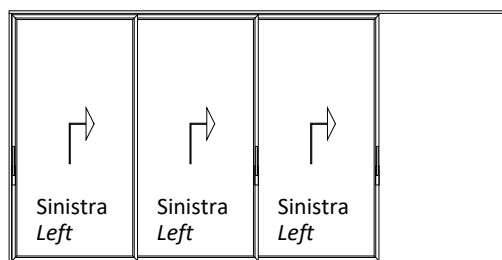
Schema | Type S3 3 ante scorrevoli a scomparsa  
3 sliding sash into the wall

Codice   Code	Descrizione   Description
AG2997S3	Kit movimentazione e tenuta 3 ante apribili 3 leaf handling and sealing kit
ACV078	Maniglione singolo Single handle
ACV078Y	Maniglione singolo con cilindro Single handle with hole cilinder
ACV178Y	Maniglione doppio con cilindro Double handle with hole cilinder

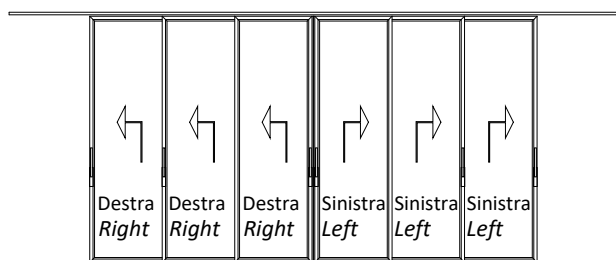
Schema | Type T3 6 ante scorrevoli a scomparsa  
6 sliding sash into the wall

Codice   Code	Descrizione   Description
AG2996T3	Kit movimentazione e tenuta 6 ante apribili 6 leaf handling and sealing kit
ACV078	Maniglione singolo Single handle
ACV078Y	Maniglione singolo con cilindro Single handle with hole cilinder
ACV178Y	Maniglione doppio con cilindro Double handle with hole cilinder

1. Controllo materiale in arrivo / *Incoming equipment Control*  
Verifica visiva dell'intergrità delle barre con attenzione a: / *Profiles wholeness visual control paying attention to:*
  - Strisci profondi / *Deep scratches* verifica visiva / *visual control*
  - Botte e avvallamenti sulla superficie / *Bumps and dips on surface* verifica visiva / *visual control*
  - Rettilinearità barre / *Profiles straightness tolerance* 0,002 x L
  - Svergolamento / *Profiles twist tolerance* 1° x m
  
2. Taglio barre e controllo barre / *Cut and Control of profiles*
  - Misura lunghezza / *Length measurement* ± 0.5 mm
  - Verifica 45° / *45° Control* ± 1°
  - Verifica 90° / *90° Control* ± 1°
  
3. Preparazione per verniciatura - brunitura / *Preparation for the powder coating - burnishing*
  - a. Fori su telaio per scarichi liquidi pretrattamento  
*Holes on frame for the drainage of pretreatment liquid*
  - b. Marcatura e imballo telai esterni e ante  
*External frames and leafs branding and packing*
  - c. Marcatura e imballo telai fermavetro  
*Glazingbeads frames branding and packing*
  - d. Marcatura e imballo profili complementari  
*Additional profiles branding and packing*
  
4. Applicazione accessori e sigillatura / *Hardware and accessories installation and sealing*
  - I. Montaggio cremonese e incontri / *Espagnolette installion*
  - II. Montaggio guarnizioni di battuta / *Gasket installation*
  - III. Sigillatura angolo nel TT / *Corner joint sealing*
  
5. Vetratura / *Glazing*
  - a. Applicazione clips fermavetro / *glazing bead clips installation*
  - b. Applicazione guarnizione esterna / *External glazing gasket installation*
  - c. Applicazione vetro (spessoramento) / *Glazing installation (setting blocks)*
  - d. Inserimento fermavetri / *Glazing beads application*
  - e. Inserimento guarnizione interna fermavetro / *Fit glazing bead to glass gasket*
  - f. Verifica corretta compressione guarnizione / *Control of the right compression of the gasket*
  
6. Controlli su prodotto finito / *Control on finished element*
  - a. Verifica distanza tra anta e telaio /  
*Control of gap between leaf and frame* +0 +0.5 mm
  - b. Verifica sormonto anta su telaio / *Control of leaf surmount* +0 +1 mm
  - c. Verifica sigillature per scarico acqua /  
*Control of central gasket sealing* test con acqua su giunto  
*test with water*
  - d. Verifica funzionamento cremonese/maniglia serratura  
*Control of hardware functioning*
  - e. Verifica finitura superficiale / *Control of surface finishing*



7. Controlli dopo la posa / *Controls after installation*
- a. Verifica corretta installazione telai: squadra, piombo, misure /  
*Control of alignment and plumbing of frame and leaf*
  - b. Verifica distanza tra anta e telaio / +0 +1 mm  
*Control of gap between leaf and frame*
  - c. Verifica sigillature per scarico acqua / test con acqua su giunto  
*Control of central gasket sealing*  
*test with water*
  - d. Verifica funzionamento cremonese/maniglia serratura  
*Control of hardware functioning*
  - e. Verifica finitura superficiale / *Control of surface finishing*

**MATERIALI****ACCIAIO INOX****Materiale**

Profilati ricavati da nastro di lamiera di acciaio inox laminato a freddo pre-trattato industrialmente per garantire la massima qualità e uniformità.

**Caratteristiche fisiche**

AISI 316L Marino (X2 CrNiMo 17-12-2)

**Norme di riferimento**

EN 10088-2; EU 114

**Trattamenti superficiali**

Finitura Scotch Brite: ottenuta su nastro AISI 316L (marino) con finitura superficiale 2B con successiva spazzolatura Scotch Brite.

**ACCIAIO COR-TEN****Materiale**

Profilati ottenuti da nastro in acciaio altoresistenziale, autopassivante (che un tempo veniva commercializzato con il nome Cor-Ten) tale da formare, se esposto all'aria, uno strato di ossido uniforme e stabile che, ricoprendo la lamiera, ne arresta la corrosione atmosferica.

**Caratteristiche fisiche**

Fe 510 X (C max % 0,12; Si % 0,25-0,75; Mn % 0,20-0,50; P % 0,07-0,15; Cu % 0,25-0,55; Cr % 0,30-1,25; Ni max % 0,65)

**Norme di riferimento**

EN 10149

**Trattamenti superficiali**

Dopo la profilatura il materiale viene immerso in speciali bagni ossidanti tali da accelerare la formazione dello strato protettivo. Raggiunta la tonalità desiderata della superficie si procede ad una ceratura di stabilizzazione del materiale.

**ACCIAIO ZINCATO VERNICIATO****Materiale**

Profilati ottenuti da nastro in lamiera di acciaio zincato a caldo sistema Sendzimir finitura skinpassata

**Caratteristiche fisiche**

FeP02 GZ 200

**Norme di riferimento**

UNI EN 10142/3/7; EURONORM 143

**Trattamenti superficiali per la verniciatura**

La preparazione del supporto zincato si effettua tramite i processi di sgrassaggio, decapaggio e lavaggio in acqua. Segue l'applicazione di uno strato di zinco per fosfatazione seguito da lavaggi in acqua demineralizzata. Infine applicazione della mano a finire con polveri poliestere cotte in forno a 180 °C per 25 minuti.

**LEGA DI RAME OT67****Materiale**

Profilati ottenuti da nastro di Lega di Rame OT67 laminato a freddo rincrudito allo stato grezzo.

**Caratteristiche fisiche**

Cu Zn 33 CW 506L (OT 67, 67% rame e 33% zinco)

**Norme di riferimento**

EN 1652:1999

**Trattamenti superficiali**

Finitura brunita: dopo la profilatura viene eseguita una ricottura di distensione, quindi la pulitura meccanica con abrasivo e la successiva brunitura per immersione con liquido brunitore; il profilo viene poi lavato e asciugato ed infine protetto mediante trattamento con olio di vaselina.

Finitura lucida: dopo la profilatura viene eseguita una ricottura di distensione e successivamente la lucidatura a specchio.

**MATERIALS****STAINLESS STEEL****Materials**

Sections processed out of the cold-rolled coils, industrially pre-treated for utmost quality and uniformity.

**Physical features**

AISI 316L Marino (X2 CrNiMo 17-12-2)

**Norms of reference**

EN 10088-2; EU 114

**Surface treatment**

Scotch Brite: obtained on AISI 316L (marine) coil 2B pre-finish with Scotch-Brite post-scrubbing.

**CORTEN STEEL****Materials**

Sections processed out of highly resistant self-oxidising steel coils – once traded under the name Cor-Ten. If exposed to the open air, it produces a uniform protective layer that reduces weather corrosion.

**Physical features**

Fe 510 X (C max % 0,12; Si % 0,25-0,75; Mn % 0,20-0,50; P % 0,07-0,15; Cu % 0,25-0,55; Cr % 0,30-1,25; Ni max % 0,65)

**Norms of reference**

EN 10149

**Surface treatment**

After forming, sections are plunged into a special oxydising bath to catalyze formation of the protective coating. Once the desired tone obtained, sections are stabilized by a wax coating.

**GALVANIZED AND PAINTED STEEL****Materials**

Sections processed out of hot galvanized steel coils, band "Sendzimir, skinpassed finishing.

**Physical features**

FeP02 GZ 200

**Norms of reference**

UNI EN 10142/3/7; EURONORM 143

**Pre-painted surface treatment**

The preparation of a galvanised surface is made through several processes: degreasing, pickling and washing. A coating of zinc is then applied through a phosphatising process followed by rinses in demineralised water. A final coat is then applied with polyester powders baked at 180 °C for 25 minutes.

**COPPER ALLOY OT67****Materials**

Sections processed out of copper alloy coils, industrially cold-rolled.

**Physical features**

Cu Zn 33 CW 506L (OT 67, 67% copper and 33% zinc)

**Norms of reference**

EN 1652:1999

**Surface treatment**

Burnished finish: after forming, the product is submitted to stress relieving, then to mechanical cleaning with abrasive products and ultimately to burnishing by plunging into a burnishing solution. It is then washed and dried and protected with a vaseline coating.

Glossy finish: after forming, the product is submitted to stress relieving and then mirror-like polished.

## INDICE ANALITICO | SUBJECT INDEX

AC2608 .....	2.9.1-2 2.9.4-6 2.9.11
AC2608AR .....	2.9.1-4 2.9.6 2.9.11
AC2609AR .....	2.9.5 2.9.11
AC2993P .....	4.2.1 4.2.4 4.2.40 4.2.54
AC2995.1 .....	4.3.2 4.3.6-7
AC2995.2 .....	4.3.3 4.3.6-7
AC2995.3 .....	4.3.4
AC2995R.xx .....	4.2.7
ACV21x.xx .....	4.3.85
ACV22x.xx .....	4.3.86
ACV22xY.xx .....	4.3.87
AG2989L.AB .....	4.3.39-83
AG2989L.EF .....	4.3.39-83
AG2992L.AB .....	4.2.76-78 4.3.39-83
AG2992L.EF .....	4.2.76-78 4.3.39-83
AG2996-7A .....	4.3.39
AG2996-7A3 .....	4.3.52-53
AG2996-7B .....	4.3.40-41
AG2996-7B3 .....	4.3.54-56
AG2996-7C .....	4.3.42
AG2996-7C3 .....	4.3.57-59
AG2996-7S1 .....	4.3.49
AG2996-7S2 .....	4.3.69-70
AG2996-7S3 .....	4.3.75-77
AG2996E .....	4.3.43-44
AG2996E3 .....	4.3.59-62
AG2996F .....	4.3.45-48
AG2996F3 .....	4.3.63-68
AG2996T1 .....	4.3.50-51
AG2996T2 .....	4.3.71-73
AG2996T3 .....	4.3.78-83
AT2900 .....	5.1.3
CV1243(I) .....	2.9.7-10
CV5012(I) .....	2.9.7-10
CV5403I .....	4.2.17 4.2.17 4.2.23 4.2.26
GU2905 .....	4.3.19-20
GU2994L .....	4.3.17-18
GU2995L .....	4.3.15-16
GU2996L .....	4.3.15-16
PA1194 .....	4.2.42-49
PA1194.NE .....	4.2.42-49



# METALFORM

MASTERS OF METAL

**UNITED KINGDOM**

**METALFORM**

**NORWAYMETAL LTD**

53 Chelsea Manor Street

London, SW3 5RZ

**SALES@METALFORM.UK**

**+44 20 81298814**

**GERMANY**

**METALFORM GMBH**

Carl-Zeiss-Ring 15A

85737 Ismaning

**SALES@METALFORMGROUP.DE**

**+49 17663630406**

**NORWAY**

**METALFORM AS**

Brochmannsveien 2

1950 Rømskog

**SALG@METALFORM.NO**

**+47 401 62 446**

**METALFORMGROUP**

**SALES@METALFORMGROUP.COM**