



1938MRR50

solid unsprung door handle on round rose

Product information

Code: 0301D009OLXX0C

Finish: brass unlacquered

UNIT: Pair

Collection: TIMELESS

Designer: Formani

EAN code: 8718009057322

TIMELESS by Formani

The TIMELESS series is a total concept collection consisting of door, window, and furniture fittings.

Finishes

- satin nickel
- bright nickel
- brass unlacquered

1938MRR50

solid unsprung lever handle
on rose

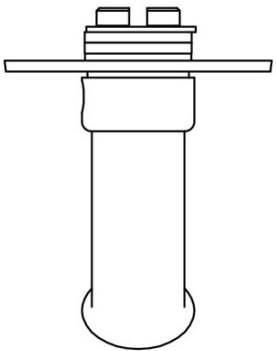
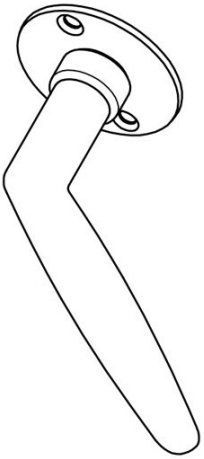
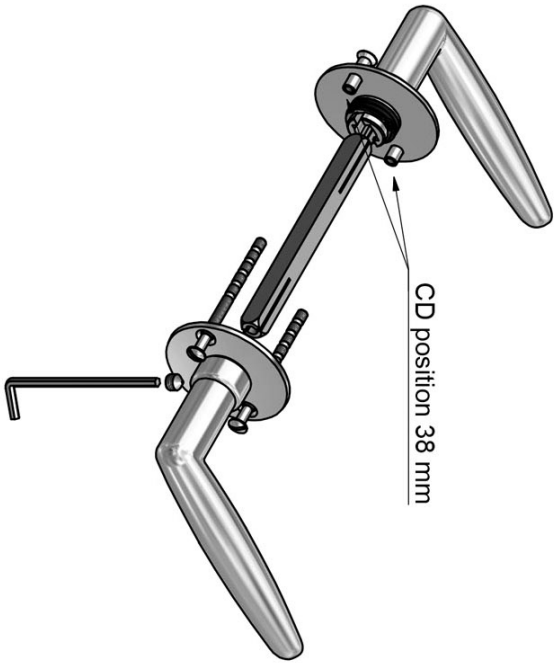

54

50

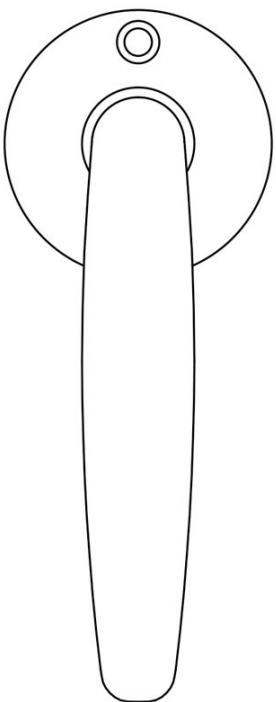

38

129

21

54

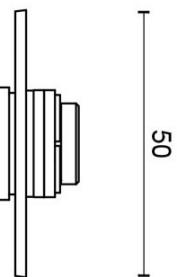

50

2,1

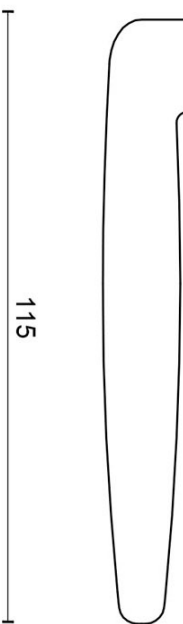

115

14,5

		Part number:	1938MRR50	Format:	A3
		Description:			
Doc no.:	0301D009 1938 MRR50 V02.dwg	Creation date:	18-12-2014		
Drawn by:	Christian Brimbois				
FORMANI HOLLAND B.V. - EUROPALAAN 12 6199 AB MAASTRICHT-AIRPORT NL - T +31 (0)43 308 90 00 INFO@FORMANI.COM FORMANI.COM					

TIMELESS

by Formani

Authenticity is what defines our TIMELESS hardware series. As the name of the series implies, the comprehensive range has stood the test of time. It comprises products from times gone by that have been given a new lease of life by FORMANI – some of which combined with elements of modern technology and functionality. The designs of the door handles in the TIMELESS collection can be traced back to the period from 1815 to 1950. The models are each named after the year in which they are fashioned. Besides the door handles, the TIMELESS series offers window and cabinet hardware and comprehensive accessories that complete the entire design. The products are available with authentic flat rosettes and shields, fastenings with vintage-design screws, materials such as brass as a base material – sometimes complemented by ebony – and original finishes in matte or glossy nickel and unlacquered brass. Where required, this authentic design is combined with contemporary technology such as SKG* safety fittings, spring mechanisms, and special PVD coatings to offer protection in the event of outdoor use.**

TIMELESS

by Formani

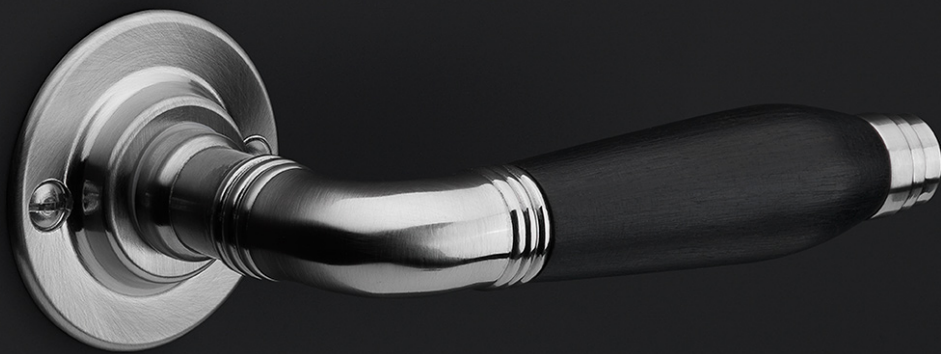

METALFORM
FORMANI®

Brand story

FORMANI has evolved considerably over the last few decades – from a Dutch family business to an internationally renowned designer brand, from door handles to total design concepts, from product development to collaborations with world-class designers. It was an evolution driven by pure ambition and courage. Our motto, ‘Obsessed with details’, epitomizes everything we do, from product to process, from strategy to service. Because it is these details that make the difference between good and perfect. At FORMANI, good is the enemy of great.

Formani Holland b.v.
Europalaan 12
6199 AB
Maastricht-Airport

T: +31(0)43 308 9000
E: info@formani.com

Chamber of Commerce:
146 27 479

**METALFORM
FORMANI®**

METALFORM

MASTERS OF METAL

UNITED KINGDOM

METALFORM

NORWAYMETAL LTD

53 Chelsea Manor Street

London, SW3 5RZ

SALES@METALFORM.UK

+44 20 81298814

GERMANY

METALFORM GMBH

Carl-Zeiss-Ring 15A

85737 Ismaning

SALES@METALFORMGROUP.DE

+49 17663630406

NORWAY

METALFORM AS

Brochmannsveien 2

1950 Rømskog

SALG@METALFORM.NO

+47 401 62 446

METALFORMGROUP

SALES@METALFORMGROUP.COM