



Profile systems

Individuality with profile systems
in steel and stainless steel

JANSEN
METALFORM

We are inspired by your ideas.
Allow our solutions to inspire you.
Create unique buildings with us
using customised profile systems
in steel and stainless steel.



METALFORM

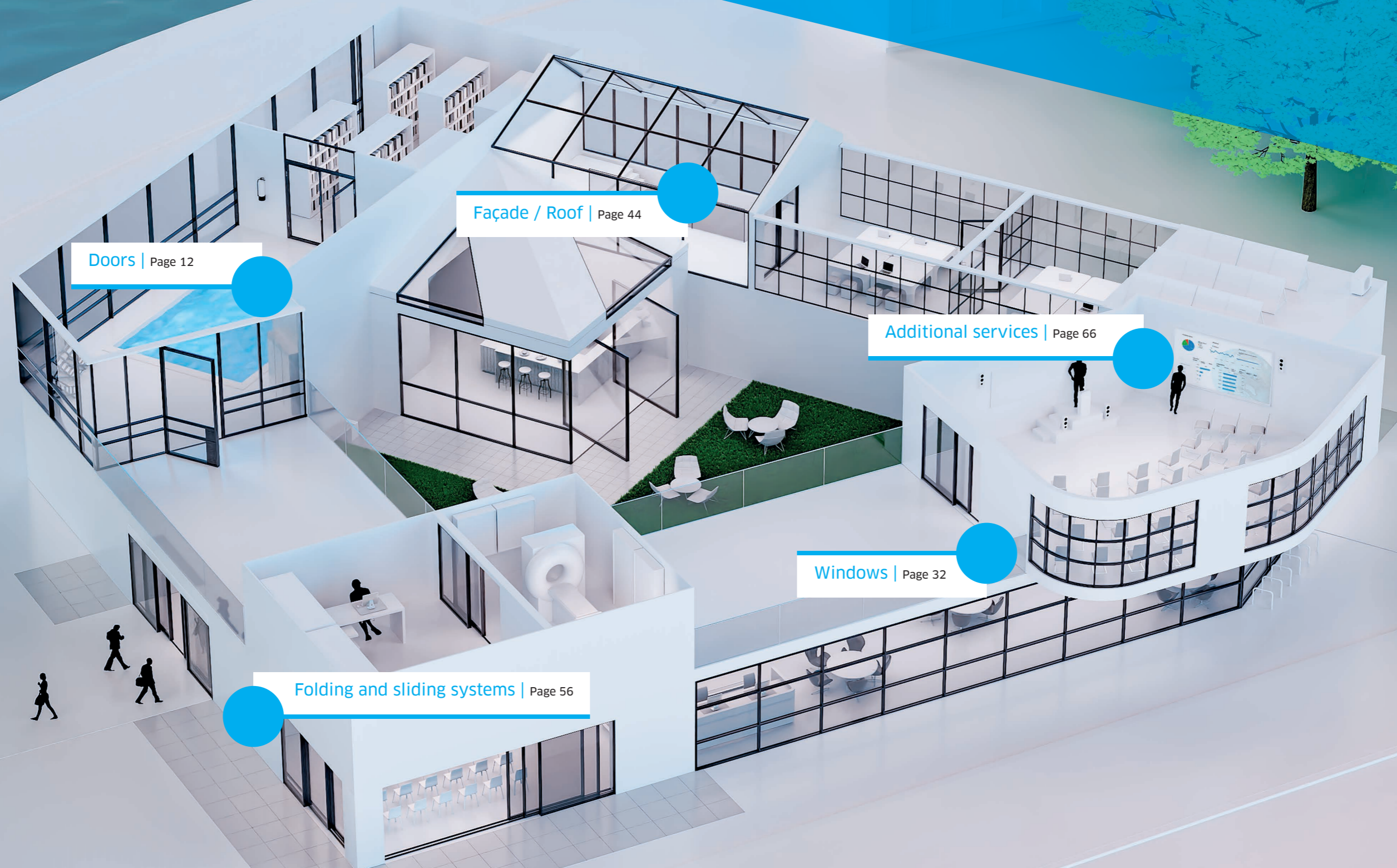

Doors | Page 12

Façade / Roof | Page 44

Additional services | Page 66

Windows | Page 32

Folding and sliding systems | Page 56

Doors

Thermally insulated doors

- Janisol
- Janisol HI
- Janisol Arte 2.0
- Janisol 2 EI30
- Janisol C4
- Janisol HI EI60/EI90/EI120
- VISS side-hung door

Non-insulated doors

- Jansen Economy 50
- Jansen Economy 60
- Jansen Art'15

Windows

Thermally insulated windows

- Janisol (including Janisol 1 and Janisol Primo)
- Janisol HI
- Janisol Arte 2.0
- Janisol Arte 66

Non-insulated windows

- Jansen Art'System
- Jansen Economy 50

VISS façade

- VISS Basic façade
- VISS Basic HI (highly insulated)
- VISS Basic burglar resistance
- VISS façade
- VISS façade HI (highly insulated)
- VISS façade burglar resistance
- VISS façade bullet resistant
- VISS façade fire protection
- VISS façade design profiles
- VISS façade SG (structural glazing)

VISS roof glazing

- VISS Basic roof glazing
- VISS roof glazing
- VISS roof glazing HI (highly insulated)
- VISS roof glazing fire protection

Folding and sliding systems

- Janisol lift-and-slide door
- Janisol folding partition
- Janisol Arte 2.0 sliding door
- Janisol 2 EI30 fire-resistant sliding door

Additional services by Jansen

- BIM (Building Information Modelling)
- JANIssoft planning software
- Machine control
- JANSEN Docu Centre
- JANSEN virtual showroom

Advantages of steel

- Steel
- sustainable
- elegant, filigree, versatile
- safe
- EPDs

System solutions – full of individual possibilities

The development and production of well-conceived system solutions made from various metals for windows, doors and façades represent a core competence of Jansen. Finding sophisticated solutions for challenging projects likewise.

Robust and resistant to mechanical damage, steel has the highest modulus of elasticity of the materials most widely used in the construction sector at 210 kN/mm². Steel is the front runner in matters of statics as well as service life, yet it can be perfectly shaped and bent. With strikingly slender profile face widths, steel is able to bear enormous loads. Thanks to its load-bearing capacity, large spans can be bridged, which enables more open areas in the building, for example, and thus permits more creative solutions.

Whether for renovations, luxury homes, industrial buildings or buildings highly frequented by the public – Jansen profile systems fully exploit the numerous benefits of steel in structural dimensioning, fire-protection applications, burglar and bullet-resistant constructions or sound reduction.

Prefabrication in the workshop removes the need for time-consuming steps when installing our systems on site. In addition, profile systems from Jansen can be easily combined with other materials and, thanks to their modular construction, can also be used flexibly for structural adaptations at short notice.

With a product range that includes thermally insulated and non-insulated door and window systems as well as façade and fire protection systems, Jansen profile systems offer sophisticated standard solutions and equally cover complex special requirements. Finally, an extensive selection of fittings and accessories, technical documentation and JANISOFT planning software as well as specialist, professional training courses and consultancy mean that architects, developers and fabricators receive products and services from a single source.



*“We are inspired by your ideas.
Allow our solutions to inspire you.
We design individual solutions for you.
Create unique buildings with us.”*

Michaela Hanesch



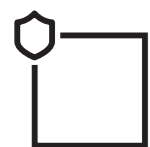

Our safety symbols

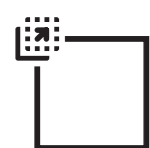
The safety symbols refer to the possibilities of the series. For example, an element may be advertised without fire protection, but the series itself may be produced with fire protection. The symbols are intended to represent the variety of options.









The higher level symbols in the top left corner represent:

-  **Protective shield:** Protective functions
-  **Cloud with rain/snow or sun:** Weather conditions
-  **Control panel:** Technology

Objective safety:
Legal requirements regarding various protective functions are ensured.

-  **Fire protection:** The transmission of fire and heat is prevented. The increase in temperature on the side of the element facing away from the fire may not exceed 180°C or an average of 140°C.
-  **Smoke protection:** In addition to flames, a fire always produces smoke. Smoke is a gas. Just a few breaths of the toxic gases carbon monoxide or carbon dioxide can be fatal. Smoke protection elements protect against this.
-  **Burglar resistance:** Burglar-resistant windows, doors and façades can protect against theft and vandalism.
-  **Bullet resistance:** Various standards describe bullet resistance for doors, windows, roller shutters, transfer trays and other bullet resistant elements.
-  **CE marking:** Elements that meet various test requirements are labelled with the CE marking or other nationally regulated marking.

Subjective safety:
Stands for mental and physical, personal well-being, which can be different for everyone.

-  **Weather conditions:** Protection from the elements such as rain, wind and a combination of the two. The elements have passed tests against wind loads, airtightness and rain.
-  **Sound reduction:** Since noise pollution can come from inside as well as outside we specify the sound reduction values for all our products.
-  **Thermal insulation:** Thermally insulated windows, doors and façades help to keep valuable heat inside: The better the thermal insulation, the less energy is lost through the building envelope.
-  **Light transmission:** Series suitable for plenty of natural light through large elements.
-  **Unpleasant odours:** Partition element - unwanted odours can be eliminated.
-  **Use:** The hand represents everything that is associated with use and therefore with the user: finger protection, fall protection, escape door, etc.
-  **Accessibility:** No problematic thresholds, automatically opening sliding or side-hung doors.
-  **Finger protection**













Our design symbols

The design symbols refer to the possibilities of the series. For example, an element may be advertised without a round arch, but the series itself may be produced with a round arch. The different symbols are intended to represent the variety of options.

 **Design on the building:** The higher level symbol in the top left corner represents the various visual, functional and practical possibilities on the building.

For lovers of aesthetics - free creativity in form, colour and expression.

Jansen offers users flexibility, safety and practical functions.

-  **Materiality:** Steel, stainless steel and Corten with a wide range of options for surface treatment. At least two materials are available for the series.
-  **Fittings:** There is at least one option for incorporating concealed fittings.
-  **Wide range of variants:** Freedom of design through simple and flexible shaping of steel. The series is also available with a round arch.
-  **Transparency for buildings:** This symbol represents the appearance. It should be noted that the series allows for different infills, particularly narrow face widths, the façade offers, for example, SG solutions, etc.
-  **Showroom:** Virtual showroom - experience Jansen steel systems online.
-  **Operation:** For the user, the weight of large and heavy sashes becomes irrelevant if the operating forces can be proven or motorisation can be integrated.
-  **Opening types:** The series has a wide range of opening variants. There are three options for doors and five for windows.
-  **Durability:** Steel per se has been estimated by various institutions to have a service life of between 75 to 100 years in its installed condition and deserves the label 'durable'.
-  **Solar shading:** Simple solar shading connection.
-  **JANIssoft:** Can be planned in JANIssoft.
-  **BIM:** Available BIM models.
-  **Processing:** Processing is simple.

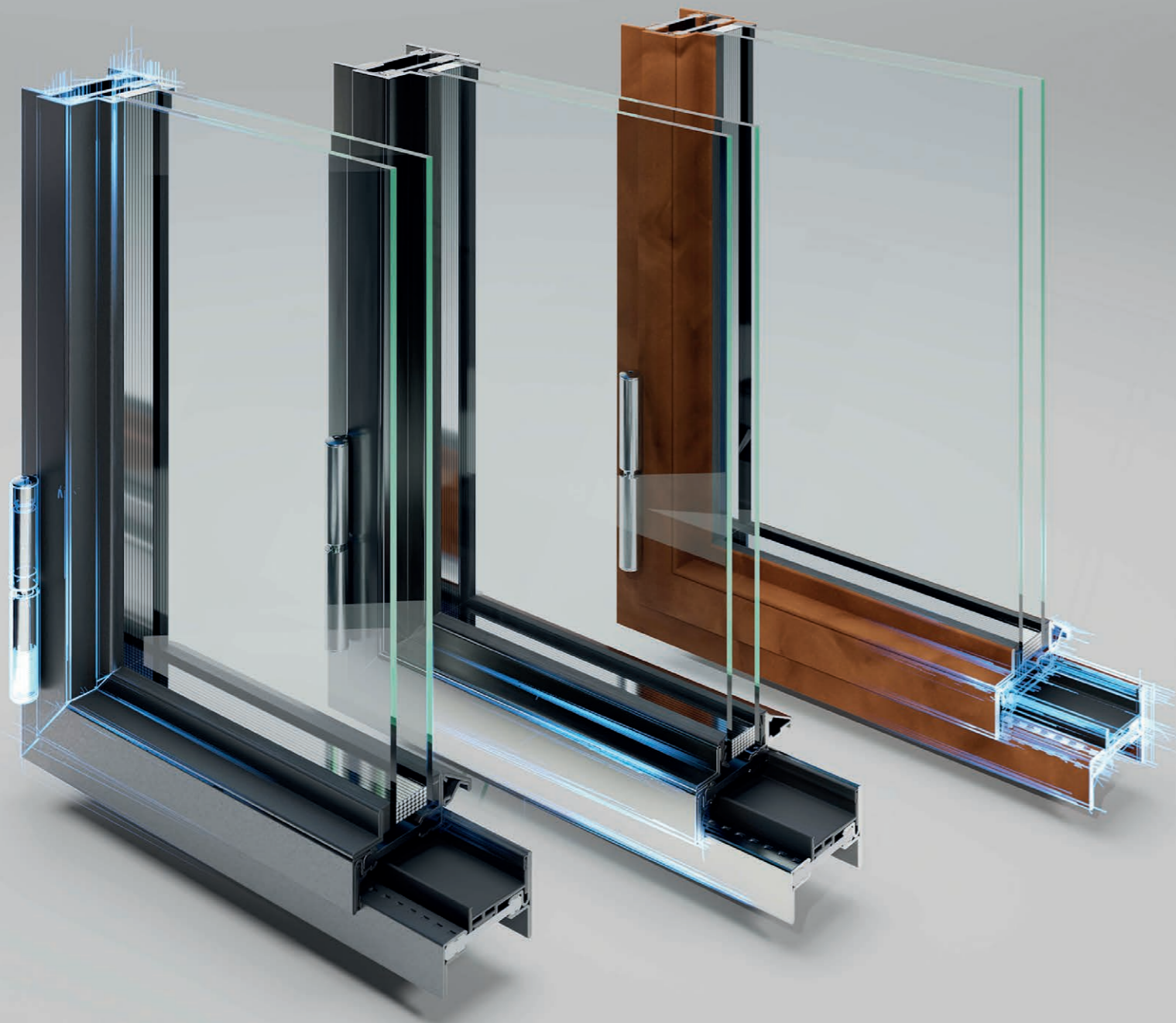

Materials & surfaces – Representing materials

A combination of properties can be selected when choosing materials. These properties relate to functional aspects such as the visual appearance and possible forms of processing. From the raw form to chemically or mechanically modified materials, colours and surfaces vary and open up a wide range of design options.

Steel / stainless steel / Corten

Steel, stainless steel and Corten offer universal design possibilities with high stability and easy fabrication. There are a few differences that are worth noting here. While steel is treated by galvanising, powder coating or wet lacquering to be protected against corrosion, stainless steel offers material properties that make further treatment unnecessary. The high-quality alloy is resistant to corrosion and its characteristic colour and structure contribute to its elegant appearance. Pre-rusted steel, Corten, is particularly suitable for creating an industrial look and retains all the static properties of the base material steel.

In our virtual showroom, we offer a design configurator that allows you to change the material and colour of doors, windows or façades in different environments.

i

You can find more detailed information in our 'Coating Guideline' brochure. Jansen steel profiles bear the GSB seal of quality, which is recertified and confirmed annually by independent testing institutes.



Surface treatment

The color concept of the profiles or fittings is determined by a surface treatment, that can either be powder coating or mechanical treatment. Each material has different basic requirements and may produce different results. Different colours are possible depending on the method used. The colour may have different gloss levels as well as metallic components. Mechanical processes such as grinding, brushing and polishing can also achieve various effects.

Surface treatment has long been used to fulfil functional as well as visual requirements. It protects the material and the resulting properties can also contribute to heat absorption or reflect the sun's rays. Certain integrated components mean that it can even help to destroy germs. When it comes to choosing a colour, the key question is where that colour is used: In areas heavily exposed to the weather, 'highly weatherproof' paints, for example, protect against premature fading.

Colour selection in our virtual showroom

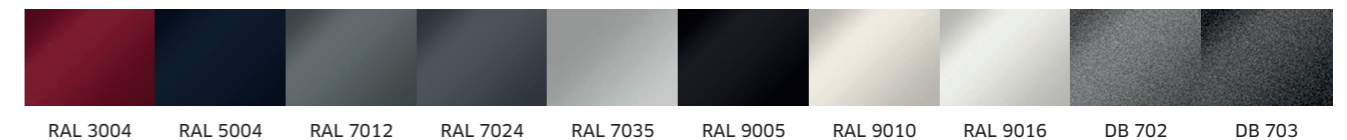

RAL 3004 RAL 5004 RAL 7012 RAL 7024 RAL 7035 RAL 9005 RAL 9010 RAL 9016 DB 702 DB 703

Door systems

Doors and windows symbolise openness and provide a way in for people, light and air. But they also protect from external influences. The individual requirements for thermal insulation and sound reduction or burglar-resistance and bullet resistance determine how doors and windows are to be constructed.

A door is a movable structural element used to close an opening (in a wall, a passageway or an entrance) which, when opened, allows passage or access. A distinction is made between external and internal doors. A door usually has an upright format. A basic distinction is made between different types of doors. The distinction is based on the type of opening. Doors can also be extended with fixed side lights and/or top lights. Top lights can take various forms. Jansen even offers them in an arched design, depending on the series.

System solutions for doors can be found in the following series:

Thermally insulated doors

- Janisol
- Janisol HI
- Janisol Arte 2.0
- Janisol 2 EI30
- Janisol C4 EI60/EI90/EI120
- VISS side-hung door

Non-insulated doors

- Jansen Economy 50
- Jansen Economy 60
- Jansen Art'15



A range of infill units also provides a variety of options for doors. The infill units can be made of glass, but can also be fully clad in sheet metal or sheet metal clad with vision panels.

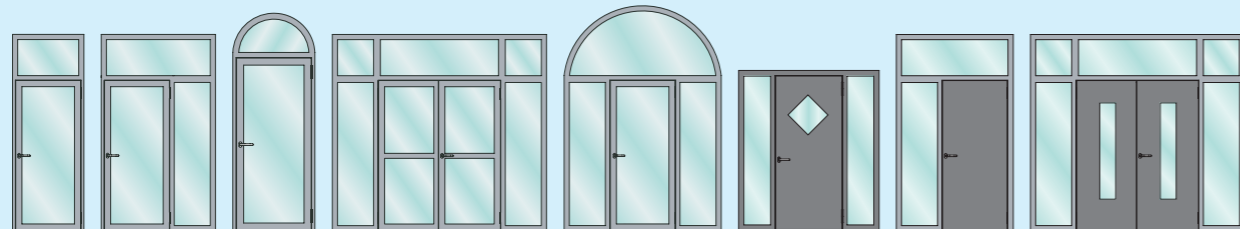

Doors with fixed side lights and top lights

Sheet metal clad doors with fixed side lights and top lights

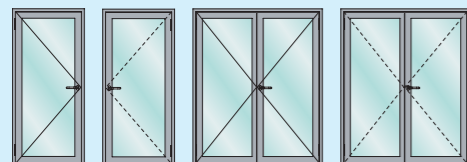

1 and 2-leaf side-hung doors

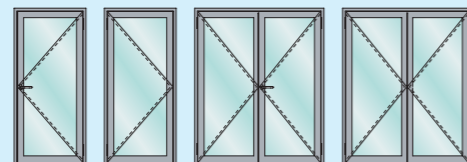

1 and 2-leaf double action doors

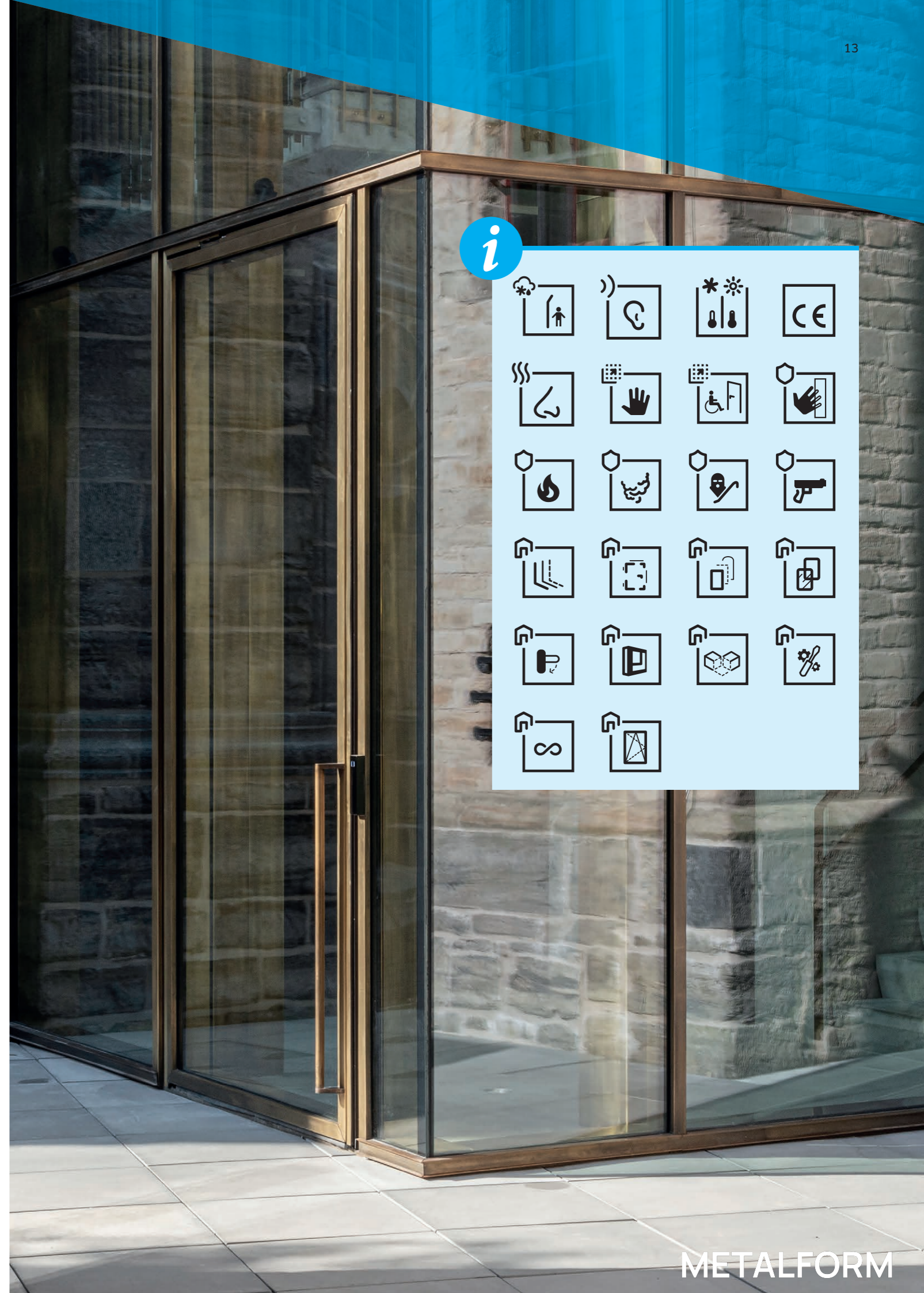
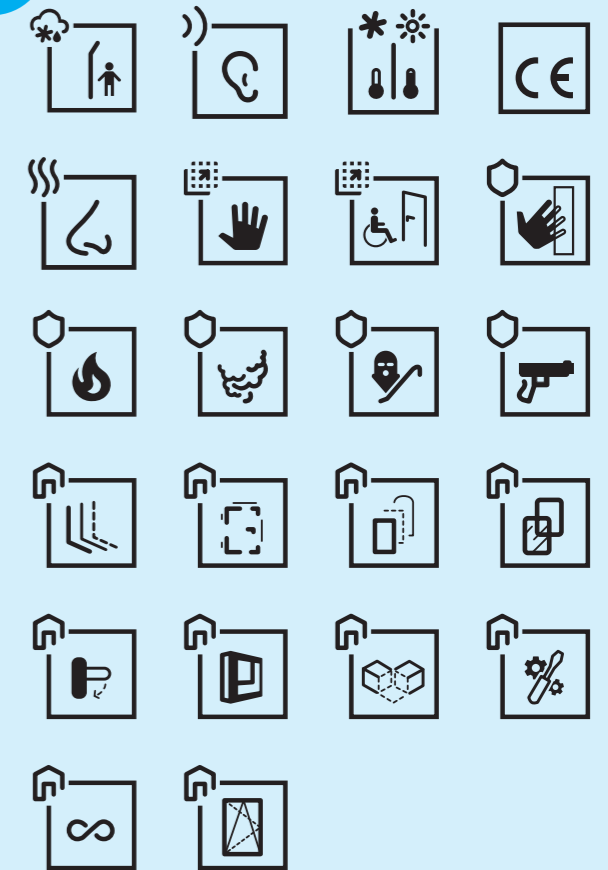

Janisol

Janisol is a thermally insulated steel and stainless steel system that is used for doors and windows.

The high resistance of steel and stainless steel makes Janisol ideal for use in high-traffic buildings such as schools, hospitals, sports centres and the like. Its elegant appearance makes the system the right choice for shopping areas, railway stations, banks and hotels.



Materials/surface finish

- Uncoated steel or strip-galvanised steel, suitable for powder coating or stove-enamelling
- Stainless steel 1.4401 uncoated or polished

Element types

- Single and double doors, with and without fixed side lights or top light, opening inwards and outwards
- Sheet metal clad doors with or without cut-outs for glazing
- Anti-finger-trap door

Design options/safety options

- Anti-finger-trap door
- Emergency exit door
- Burglar-resistant door (up to RC3)
- Bullet resistant door (FB4 - FB6 (S/NS))
- Barrier-free door

Special solutions

- Pivot door
- Door with structural glazing

Special technical features

- Special geometries (semi-circular tops)
- Basic depth 60 mm
- Face width frame - leaf from 107.5 mm
- Faceplate width from 155 mm
- Leaf sizes up to 3000 mm
- Leaf weight up to 230 kg

Your benefits

- Flush-fitted on the inside and outside
- Combinations of design options cover a wide range of application requirements
- CE marking for special geometries

Section detail

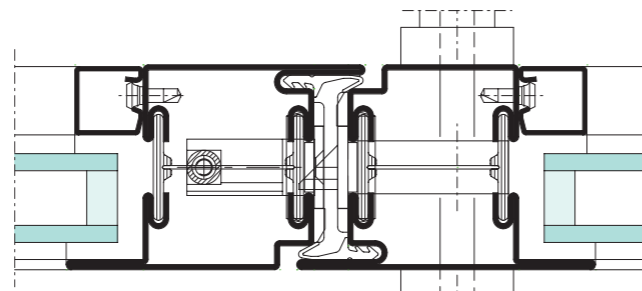

Design/safety options

Anti-finger-trap door

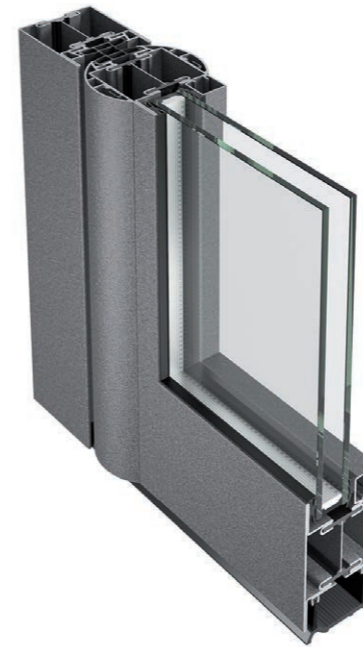

Burglar-resistant door RC

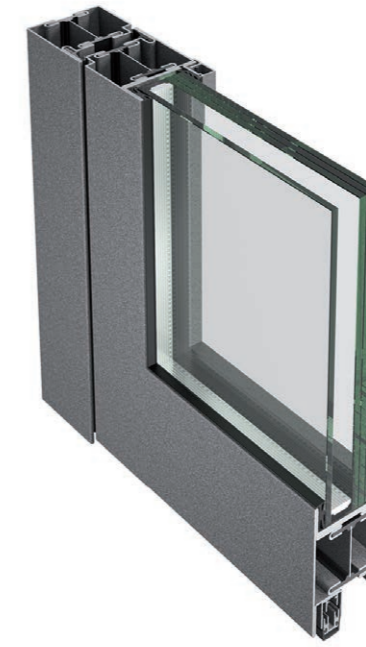

Barrier-free door

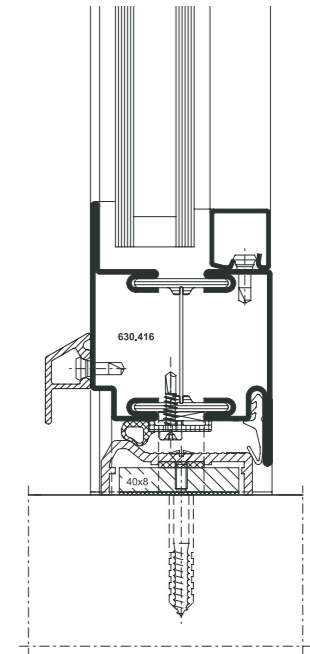

Bullet resistant door



Emergency exit door



Janisol HI

The Janisol HI door system fulfils the highest insulation requirements and, with respect to safety/security and durability, is also suitable for extreme service conditions – such as those in very busy public buildings. With triple glazing, it is easy to achieve excellent thermal conductivity coefficients. With Janisol HI, Jansen sets new benchmarks in terms of contemporary architecture.



Materials/surface finish

- Strip-galvanised steel, suitable for powder coating or stove-enamelling

Element types

- Single and double doors, with and without fixed side lights or top light, opening inwards and outwards
- Sheet metal clad doors with or without cut-outs for glazing

Design options/safety options

- Emergency exit door
- Burglar-resistant door (up to RC3)

Special technical features

- Special geometries (semi-circular tops)
- Basic depth 80 mm
- Leaf sizes up to 3000 mm
- Leaf weight max. 280 kg
- Glass thicknesses from 24 mm – 57 mm
- Single-latch lock or motorised multipoint lock

Your benefits

- High thermal insulation
- Additional profiles with a chamber size of 85 mm allow the installation of locks with increased backset
- CE marking for special geometries

Additional information

- Mechanical durability up to 1,000,000 cycles

Section detail

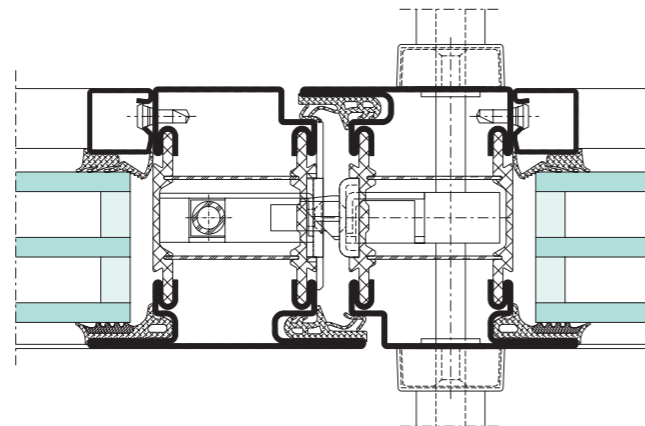

Design/safety options

Emergency exit door



Burglar-resistant door RC1 to RC3

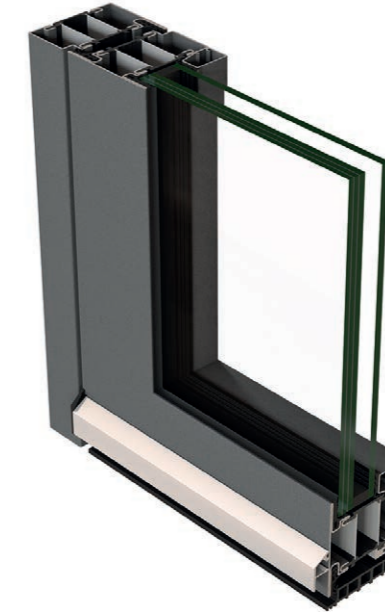

Janisol Arte 2.0

Janisol Arte offers CE-certified doors in a thermally insulated system with extremely narrow face widths for interior and exterior use. Originally designed specifically to preserve the value of listed buildings, the narrow profile face widths with the largest possible proportion of glass are also perfect for use in modern residential construction, for example as indoor partitions. Compatible with the Janisol Arte 2.0 window system for more architectural freedom.

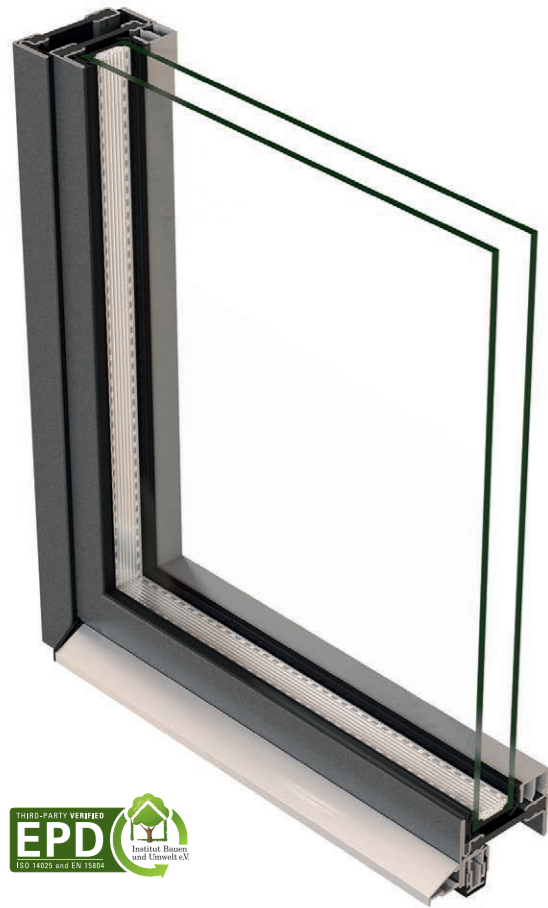

Materials/surface finish

- Strip-galvanised steel, suitable for powder coating or stove-enamelling
- Stainless steel 1.4401 uncoated or polished
- Corten

Element types

- Single and double doors, with and without fixed side lights or top light, opening inwards and outwards
- Sheet metal clad doors with or without cut-outs for glazing

Design options/safety options

- All-glass appearance
- Door with barrier-free threshold
- Door with zero threshold

Special technical features

- Basic depth 60 mm
- Leaf height up to 2489 mm clearance dimension
- Leaf weight max. 150 kg
- Face width from 45 mm

Your benefits

- Compatible with Janisol Arte 2.0 and 66 window systems; allows semi-circular top over the door, for example for listed buildings
- Use in high-traffic buildings with durability class 7 (500,000 cycles)
- Add visual interest by using designer glazing beads

Section detail

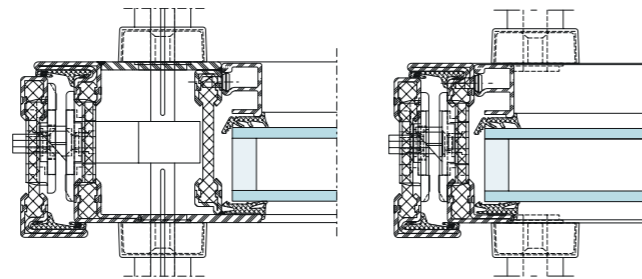

Design/safety options

Door with all-glass appearance



Door with barrier-free threshold

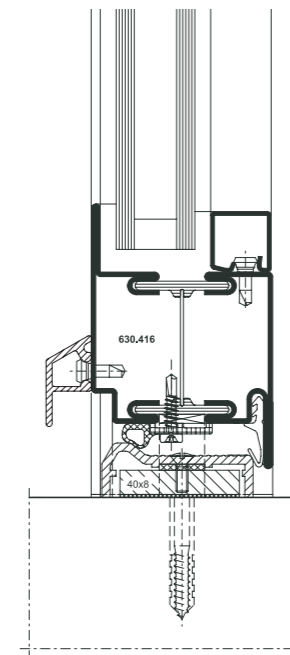

Door with zero threshold

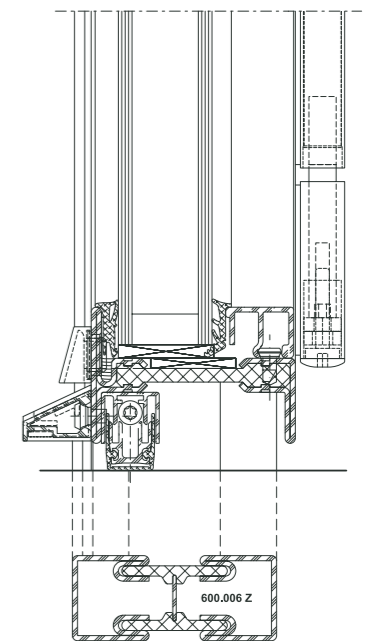

Janisol 2 EI30

The Janisol 2 thermally insulated fire protection system meets the requirements for structural safety and design freedom like no other system. The material properties of steel make it possible to create very strong and secure designs with extremely slender profiles. The result here is multifunctional doors and partition walls that satisfy the requirements of both the architect and the client.

These doors and partitions are used in both domestic and public/commercial areas to seal off fire compartments and significantly delay the spread of fire and smoke. They protect escape routes in stairwells or corridors, and can also meet a wide range of requirements in the building envelope with additional features such as finger protection, burglar resistance or emergency exit functions.

Please note country-specific approvals for fire protection.



Materials/surface finish

- Strip-galvanised steel, suitable for powder coating or stove-enamelling
- Stainless steel 1.4401 uncoated or polished

Element types

- Single and double doors, with and without fixed side lights or top light, opening inwards and outwards
- Sheet metal clad doors with or without cut-outs for glazing
- Partitions with free glass edges
- Also available as a fire-resistant sliding door

Design options/safety options

- Fire protection combination EI30/EI60 (Janisol 2 with Janisol C4)
- Emergency exit door
- Burglar-resistant door up to RC3
- Anti-finger-trap door
- Smoke protection according to EN 1634-3, EN 13501-2 and DIN 18095

Special technical features

- Leaf height up to 2500 mm with single-latch lock
- Leaf height up to 3000 mm with single-latch lock and bimetal latch or top lock
- Motorisation possible
- Dry or wet glazing

Your benefits

- Multiple safety/security applications in one system means the same look with changing application functionality
- Add visual interest by using various glazing beads
- Full automation enables contactless access

Section detail

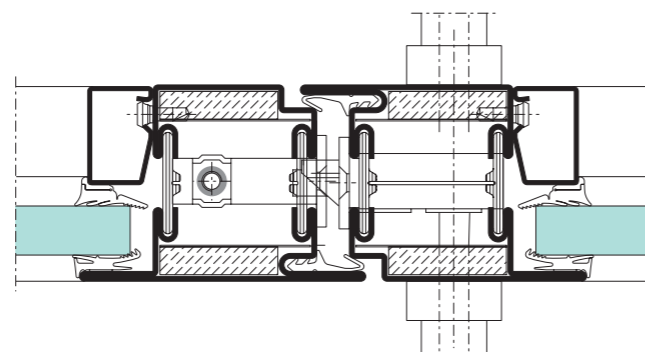

Design/safety options

Smoke protection door



Emergency exit door



Anti-finger-trap door



Burglar-resistant door up to RC3

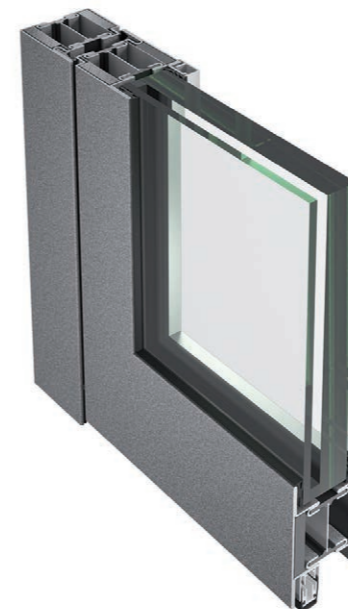

Fire protection combination EI30/EI60



Janisol C4 EI60/EI90/EI120

The innovative fire protection filling of the Janisol C4 system provides maximum safety in terms of fire protection with a fire resistance of up to 60, 90 or 120 minutes. The appearance of the Janisol C4 fire-resistant construction is identical to the other Jansen fire protection barriers and the thermally insulated Janisol systems. Janisol C4 permits the use of particularly narrow outer frame profiles.

These fire protection requirements are often needed to secure escape routes, which requires an electronic connection to monitoring or alarm systems. Cable channels integrated as standard in the ceramic compound facilitate secure electronic connection.

The same face width as other Jansen fire and/or smoke protection solutions creates a wide range of possible applications, as the most diverse requirements within a building can be met with a consistent appearance.

Please note country-specific approvals for fire protection.

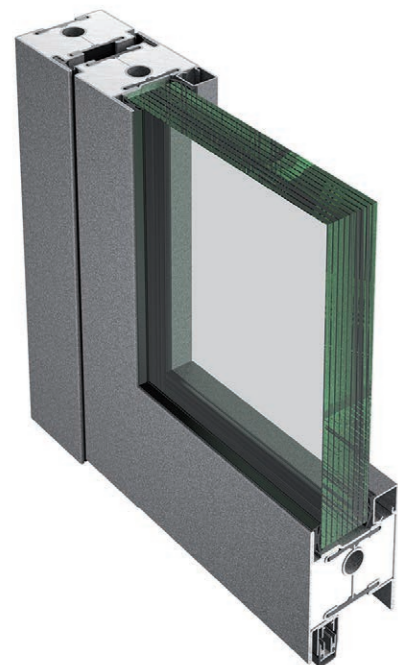

Materials/surface finish

- Uncoated steel or strip-galvanised steel, suitable for powder coating or stove-enamelling up to EI90
- Stainless steel 1.4401 uncoated or polished

Element types

- Single and double doors, with and without fixed side lights or top light, opening inwards and outwards
- Partitions

Design options/safety options

- Fire protection combination EI30/EI60 (Janisol 2 with Janisol C4)
- Emergency exit door

Special solutions

- Fire protection wall EI120

Special technical features

- Leaf height up to 2500 mm with single-latch lock
- Motorisation possible
- Dry or wet glazing

Your benefits

- Fire protection, smoke protection and emergency exit function in one solution
- Compatibility with other systems guaranteed
- fulfilment of various fire protection requirements with a consistent look
- Add visual interest by using designer glazing beads

Section detail

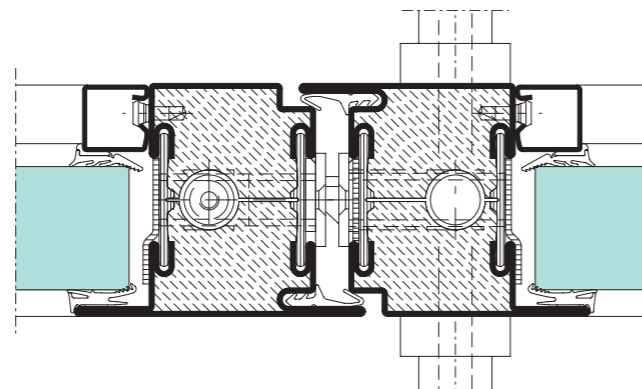

Design/safety options

Emergency exit door



Fire protection combination EI30/ EI60



VISS side-hung door

A thermally insulated mullion-transom construction for single and double-leaf façade doors with an impressive size of up to 2000 mm × 6000 mm (W × H) and therefore ideal as a generous façade opening. The VISS side-hung door is used in particular as an access door for transport purposes in exhibitions, car show-rooms or museums. Available in both 50 mm and 60 mm face widths, it blends in perfectly with the building envelopes of the tried-and-tested VISS façade system.



Materials/surface finish

- Uncoated steel or strip-galvanised steel, suitable for powder coating or stove-enamelling

Element types

- Single and double doors, with and without fixed side lights or top lights

Special technical features

- With 50 mm / 60 mm face width
- Various cylinder options
- Glass thicknesses from 17 mm - 52 mm

Your benefits

- 6000 mm tall door with CE marking
- Stainless steel cover sections for added elegance
- Up to 550 kg leaf weight with only 4 hinges

Section detail

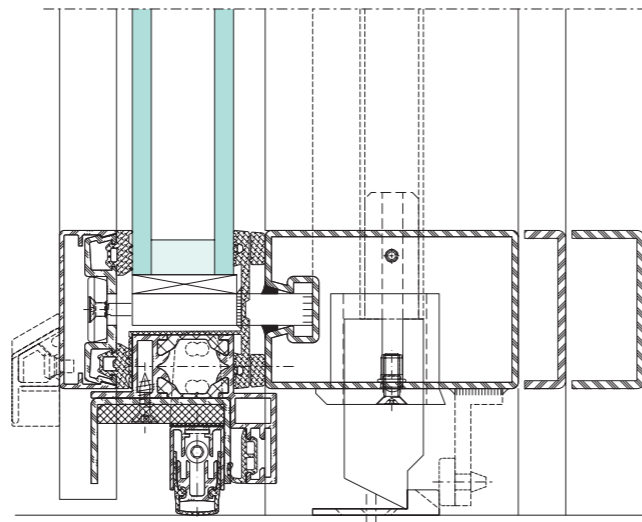

Jansen Economy 50

With this non-insulated solution, Jansen offers flush doors for efficient fabrication. The doors radiate elegance with a shadow gap running from the inside to the outside, making them ideal for high-quality interior design. Safety requirements in terms of fire resistance or smoke protection are also guaranteed with these doors. The comprehensive range also includes applications with finger-trap protection, so that not only office buildings but also nurseries and schools can be safely equipped. Round arches provide additional creative freedom.

Please note country-specific approvals for fire protection.



Materials/surface finish

- Uncoated steel or strip-galvanised steel, suitable for powder coating or stove-enamelling
- Stainless steel 1.4404 uncoated or polished

Element types

- Single and double doors, with and without fixed side lights or top lights
- Sheet metal clad doors with and without cut-outs for glazing

Design options/safety options

- Fire protection door
- Smoke protection door
- Emergency exit door
- Bullet resistant door up to FB6/NS
- Barrier-free door
- Door with zero threshold
- Anti-finger-trap door
- Double action door

Special technical features

- Special geometries (semi-circular tops)
- Motorisation possible
- Dry or wet glazing

Your benefits

- Combinations of design options cover a wide range of application requirements
- Add visual interest by using designer glazing beads

Section detail

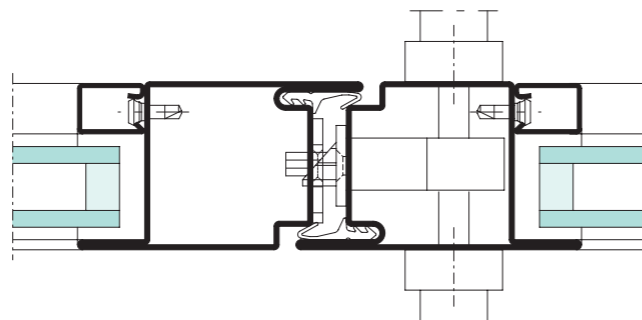

Design/safety options

Fire protection door



Smoke protection door



Emergency exit door



Anti-finger-trap door

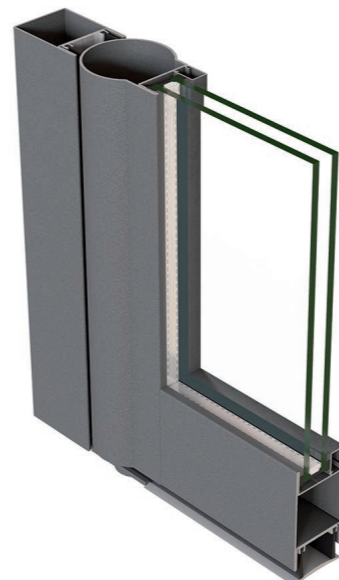

Double action door

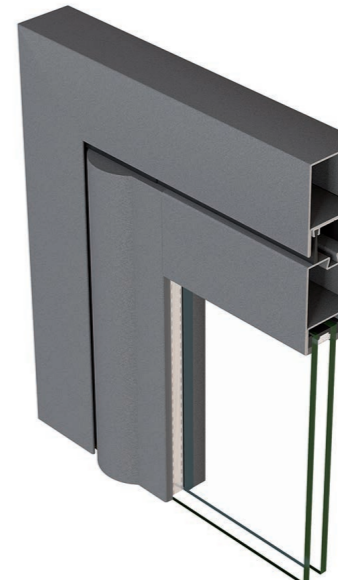

Door with zero threshold

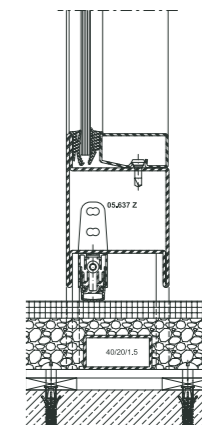

Barrier-free door

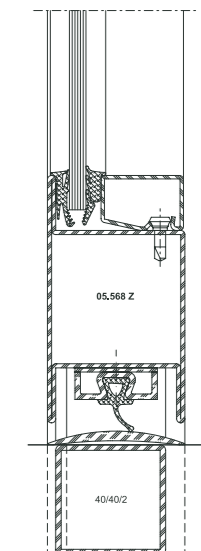

Jansen Economy 60

This non-insulated system is specially designed for large-dimensioned single and double-leaf door constructions and fixed glazing. It is therefore ideally suited for high traffic indoor areas with safety/security requirements.

The flush-fitted units have an elegant appearance thanks to the shadow gap running around the inside and outside. Compatibility with the face widths of other systems means that the same face widths can be used for different requirements. Creative freedom is therefore not restricted by regulatory requirements.

Please note country-specific approvals for fire protection.



Materials/surface finish

- Uncoated steel or strip-galvanised steel, suitable for powder coating or stove-enamelling

Element types

- Single and double doors, with and without fixed side lights or top lights
- Sheet metal clad doors with and without cut-outs for glazing

Design options/safety options

- Fire protection door
- Smoke protection door
- Emergency exit door
- Burglar-resistant door (up to RC3)
- Bullet resistant door (FB4 - FB6 (S/NS))
- Barrier-free door
- Door with zero threshold
- Anti-finger-trap door

Special technical features

- Special geometries (semi-circular tops)
- Motorisation possible
- Installation with concealed hinges possible

Your benefits

- Particularly elegant appearance with shadow gap and concealed hinges
- Combinations of design options cover a wide range of application requirements

Section detail

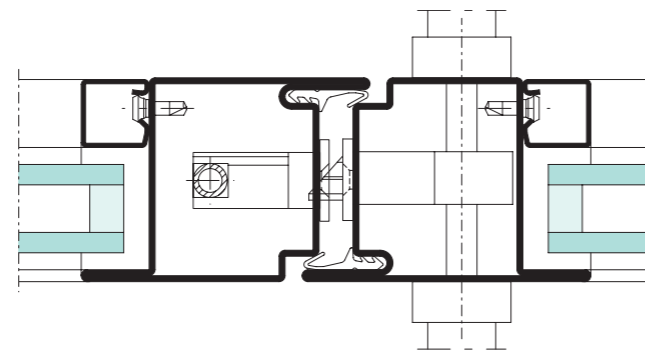

Design/safety options

Fire protection door



Smoke protection door



Emergency exit door



Anti-finger-trap door



Bullet resistant door



Burglar-resistant door

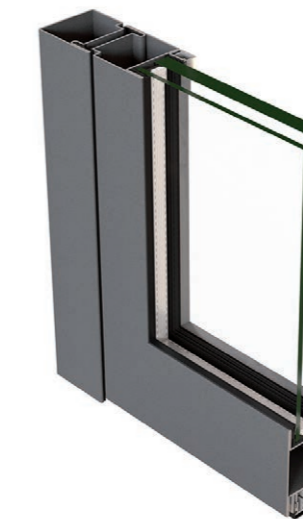

Door with zero threshold

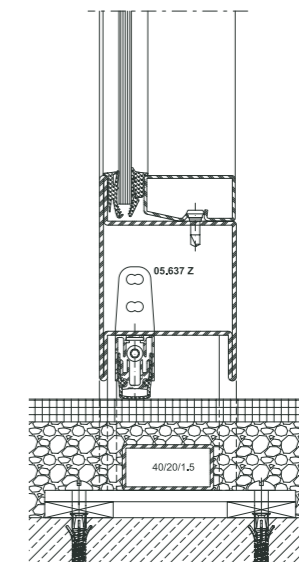

Barrier-free door

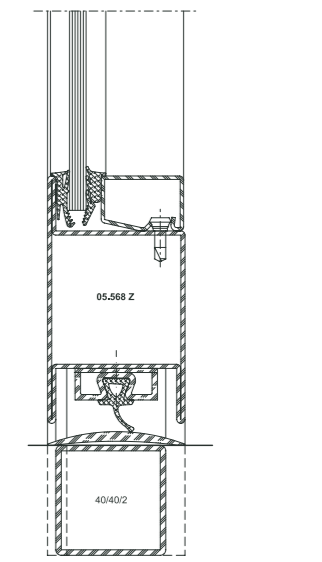

Jansen Art'15

This non-insulated system features filigree yet highly stable doors and fixed glazings. Elements made from it create attractive eye-catchers with the look and feel typical of steel.

With individual design options, transparent room solutions can be created, for example, to separate the entrance area from the living space. Noise and odours remain where they come from, but generous open space is retained. The system is designed for interior use.



Materials/surface finish

- Uncoated steel or strip-galvanised steel, suitable for powder coating or stove-enamelling

Element types

- Single and double (interior) doors, with and without fixed side lights or top lights
- Fixed glazing (interior)
- Sheet metal clad doors with and without cut-outs for glazing

Design options/safety options

- Barrier-free door
- Door with zero threshold

Special technical features

- sash weight 100 kg
- sash height up to 2400 mm
- Special geometries (semi-circular tops)
- Flush-fitted, face-fitted or rebated design

Your benefits

- Attractive interior doors and room dividers
- Special geometries such as oval arches or pointed arches

Section detail

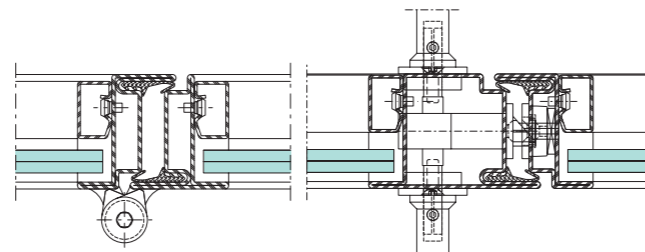

Design/safety options

Barrier-free door

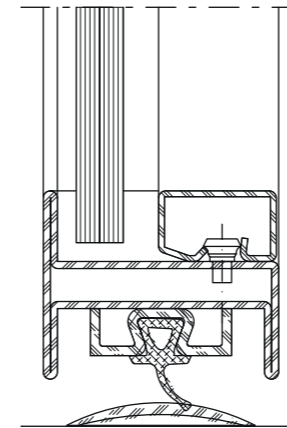

Door with zero threshold

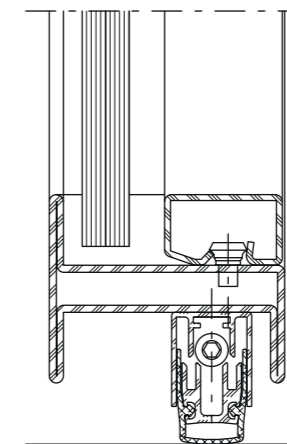
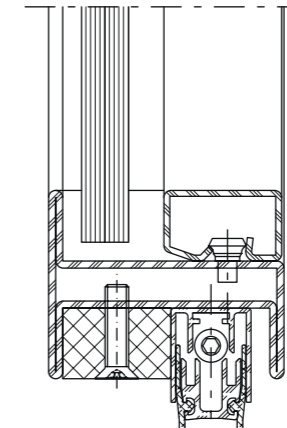

Window systems

Window solutions from the Jansen system families focus on people and their well-being. They are the natural basis for the aesthetic design of inviting bright living and working spaces in which we feel safe and comfortable. Windows not only separate the inside from the outside, but they also score points with security aspects such as thermal insulation or protection against burglary.

The term window is generally used to refer to a closable and weatherproof opening in the outer shell or roof of a building. They are normally used to let light into the interior and can be opened for ventilation. They are available in a wide variety of sizes and shapes to suit the building or site conditions. They can also be used as so-called French windows, in which case they are usually installed on upper floors as access to a balcony or roof terrace. They can be locked when used to prevent unwanted opening and can have different types of opening depending on the situation.

System solutions for windows can be found in the following series:

Thermally insulated windows

- Janisol
- Janisol primo
- Janisol 1
- Janisol HI
- Janisol Arte 2.0
- Janisol Arte 66

Non-insulated windows

- Jansen Art'System
- Jansen Economy 50



Janisol

Janisol Primo

Janisol 1

Thermally insulated windows from the Janisol system solution offer narrow face widths combined with maximum functionality and safety/security. For example, burglar resistance is guaranteed up to RC3, and FB4-FB6 bullet resistance is available for buildings requiring extra protection. The Janisol 1 version offers fire protection with E30/45 and EW30/45. With a wide range of opening options, they can be used flexibly in both new buildings and renovations. The Janisol window is a successful symbiosis of design and safety/security. The Janisol Primo version offers even better insulation values.

Please note country-specific approvals for fire protection.



Materials/surface finish

- Strip-galvanised steel, suitable for powder coating or stove-enamelling
- Stainless steel 1.4401 uncoated or polished (Janisol only)

Element types

- Single and double leaf windows, with and without fixed side lights or top light
- Side-hung, tilt/turn, bottom-hung and casement windows
- Horizontal pivot windows (Janisol only)
- Fixed glazing

Design options/safety options

- Burglar resistance RC1N to RC3
- bullet resistant FB6
- NSHEV
- Fire protection with Janisol 1

Special technical features

- Basic depth 60 mm / 64 mm
- Sash size e.g. side-hung and tilt/turn windows up to 1475 mm × 2300 mm (W × H)
- Frame face width incl. sash 82.5 mm
- Faceplate width 103 mm

Your benefits

- System solution and CE marking for special shapes such as round arches or studio windows
- RFID monitoring possible
- Concealed fitting for sash weights of up to up to 180 kg (not for Janisol 1 with fire protection)

Section detail

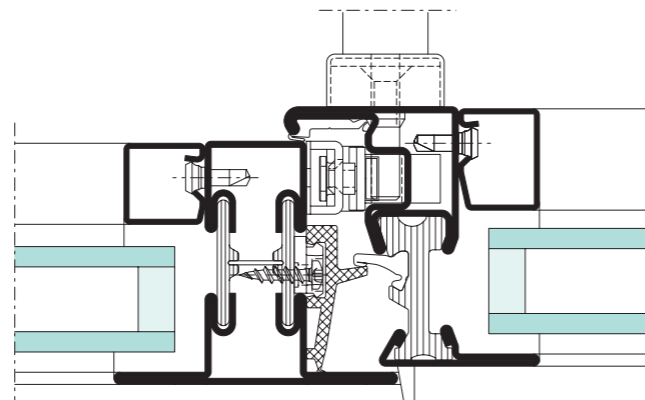

Design/safety options Janisol

Burglar-resistant window



Design/safety options Janisol Primo

Increased thermal insulation



Design/safety options Janisol 1

Fire protection window



Bullet resistant window

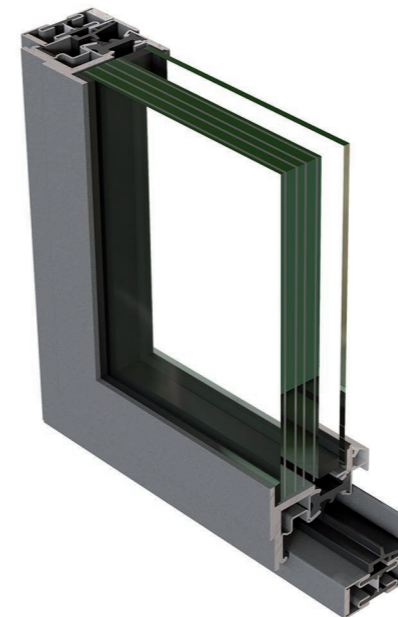

Janisol Primo section detail

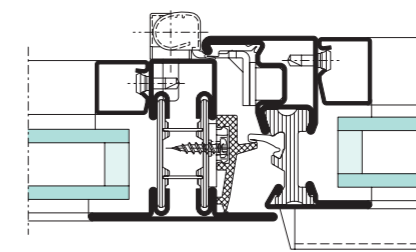

Janisol 1 section detail

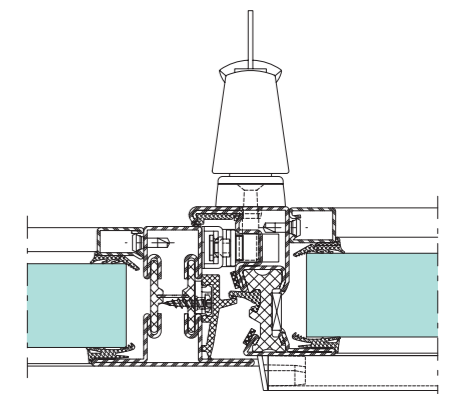

Janisol HI

Janisol HI windows are the highly thermally insulated solution for double or triple-glazed insulating glass with the narrow face widths typical of steel. With the composite used, we achieve the best U_f values and excellent static performance values at the same time. This means that nothing stands in the way of using large glass panes.

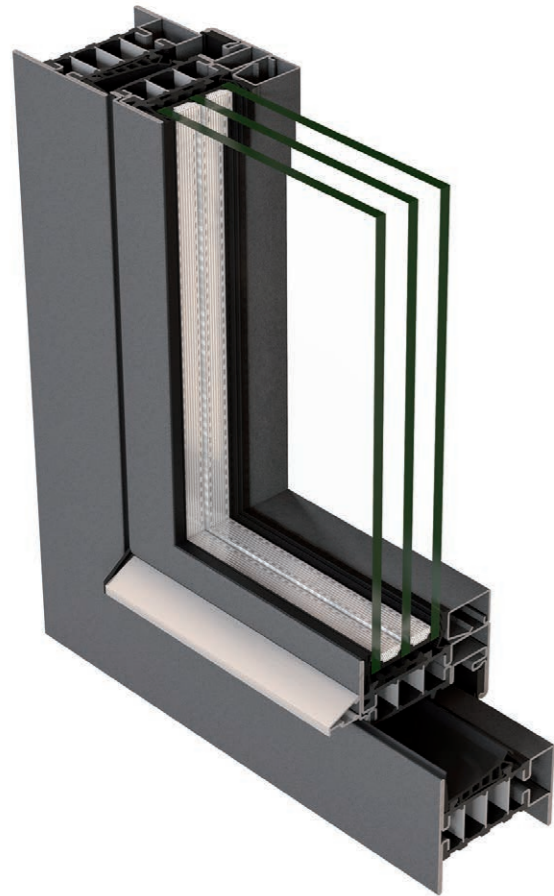

Materials/surface finish

- Strip-galvanised steel, suitable for powder coating or stove-enamelling

Element types

- Single and double sash windows, with and without fixed side lights or top light
- Side-hung, tilt/turn, bottom-hung and casement windows
- Fixed glazing

Design options/safety options

- Burglar resistance RC1N to RC3

Special technical features

- Basic depth of sash 90 mm, fixed glazing 80 mm
- Sash size e.g. side-hung and tilt/turn windows up to 1435 mm × 2760 mm (W × H)
- Frame face width incl. sash 90 mm
- Faceplate width 110 mm

Your benefits

- System solution and CE marking for special shapes such as studio windows
- Large formats with sash heights of up to 2760 mm
- Concealed fitting for sash weights of up to 180 kg

Section detail

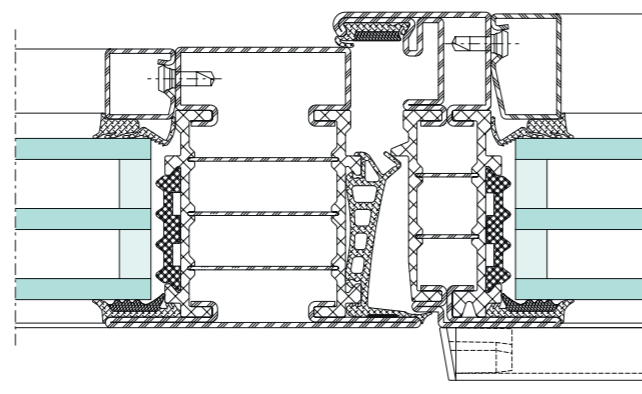

Design/safety options

Burglar resistance RC1-RC3

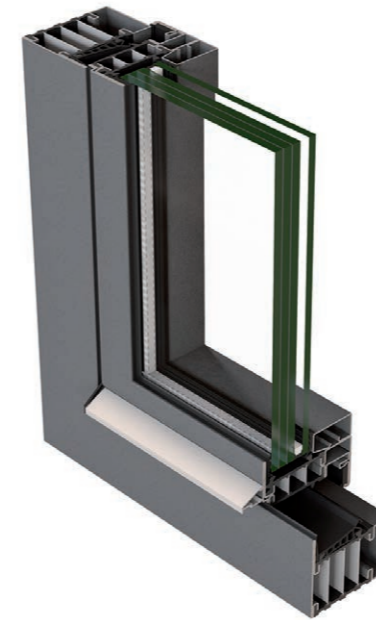

Janisol Arte 2.0

Safety, security, well-being, design, ease of fabrication, variety of opening types and materials: Janisol Arte 2.0 windows leave almost nothing to be desired when it comes to windows and flexibility. Elegant, slim and thermally insulated, these windows are ideal for renovations or new buildings, allowing generous proportions of glass with filigree profiles. In combination with Janisol Arte 66 and Janisol Arte 2.0 doors and sliding doors, uniform concepts for stylish rooms can be realised.



Materials/surface finish

- Strip-galvanised steel, suitable for powder coating or stove-enamelling
- Stainless steel 1.4401
- Corten

Element types

- Single and double sash side-hung and casement windows, opening inwards and outwards
- Bottom-hung window, opening inwards
- Top-hung and projected top-hung windows, opening outwards
- Horizontal pivot windows
- Vertical pivot windows
- French window
- Fixed glazing

Design options/safety options

- Burglar resistance up to RC2

Special technical features

- Basic depth 60 mm
- As a project solution, sash size up to 970 mm × 2970 mm (W × H)
- Fixed glazing face width 25 mm
- Faceplate width 60 mm

Your benefits

- Various opening types - the right window for every room
- Available in all materials (steel, stainless steel, Corten) from stock
- Special shapes such as arched windows with CE marking

Section detail

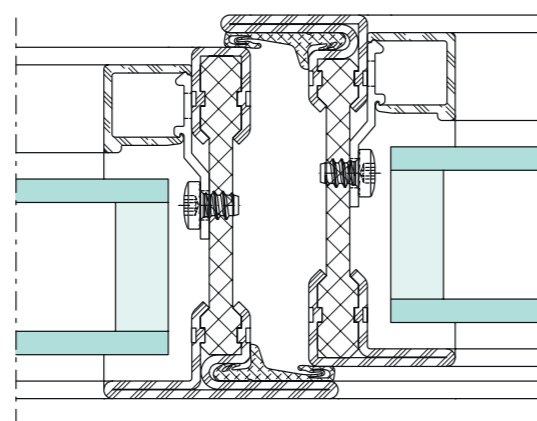

Design/safety options

Burglar resistance



Burglar resistance RC2



Janisol Arte 66

The addition of the Janisol Arte 66 solution for inward-opening side-hung, tilt/turn and bottom-hung windows to the tried and tested Arte system is an elegant, also thermally insulated addition to the Janisol Arte 2.0 system and rounds off the range of opening types. With a harmonised design and excellent structural properties, Janisol Arte 66 allows large window openings to be combined with good values in terms of sound insulation or wind and water resistance.

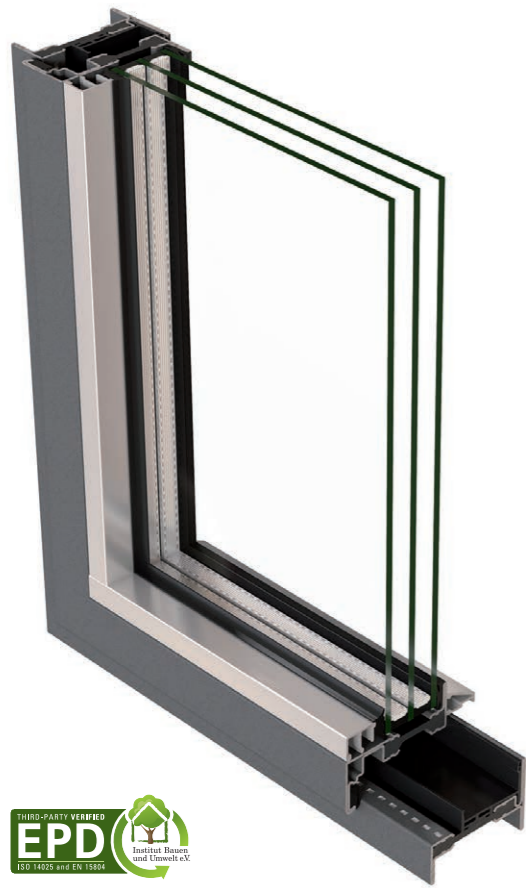

Materials/surface finish

- Strip-galvanised steel, suitable for powder coating or stove-enamelling
- Corten

Element types

- Side-hung and tilt/turn windows as well as casement windows single and double sash, opening inwards
- Bottom-hung window, opening inwards
- Fixed glazing

Design options/safety options

- Motorised bottom-hung windows possible
- NSHEV

Special technical features

- Basic depth 66 mm
- As a project solution, sash size up to 1160 mm × 3560 mm (W × H)
- Fixed glazing face width 30 mm
- Faceplate width 76 mm

Your benefits

- Special shapes such as arched windows
- Invisible transitions between Janisol Arte 2.0 and Janisol Arte 66 provide creative freedom
- Wet and dry glazing options allows for design variations

Section detail

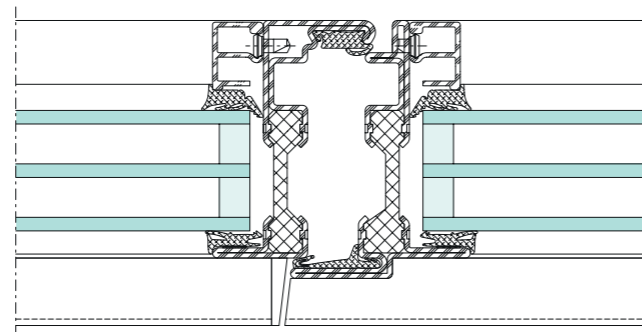

Jansen Art'System

The non-insulated system, developed for the conservation of historical monuments, is hardly distinguishable from the existing windows once installed. Jansen Art'System perfects filigree design with sash face widths of just 25 mm. With this concept, the solution is used for rooms flooded with light. The sealing concept achieves excellent sound insulation values, so nothing stands in the way of using a French window indoors.



Materials/surface finish

- Strip-galvanised steel, suitable for powder coating or stove-enamelling
- uncoated

Element types

- Single and double sash side-hung windows, opening inwards
- Bottom-hung window, opening inwards
- French window

Special technical features

- Basic depth 50 mm
- Sash size up to 872 mm × 2072 mm (W × H)
- Faceplate width 75 mm
- Combination with Jansen-Economy 50 possible

Your benefits

- Special shapes such as arched windows
- Locks and handles for French windows (special construction)

Section detail

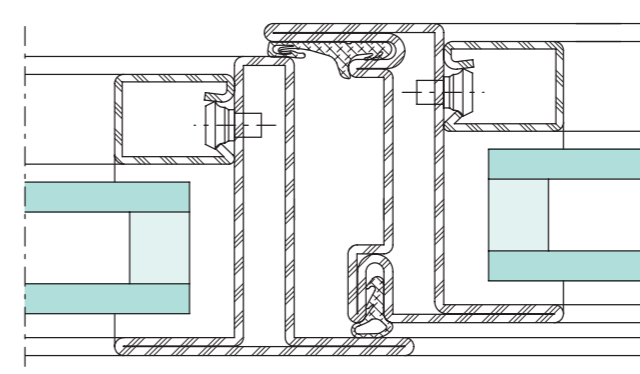

Jansen- Economy 50

This non-insulated solution is a real eye-catcher: slender lines allow the design of filigree windows with large glass inserts. At the same time, Jansen-Economy 50 can also reassure you in the non-insulated area when it comes to safety and security: the window has been tested against burglary and bullet impact with excellent results.



Materials/surface finish

- Strip-galvanised steel, suitable for powder coating or stove-enamelling
- Stainless steel 1.4404 uncoated or polished

Element types

- Single and double sash windows, with and without side lights or top light
- Side-hung, tilt/turn, bottom-hung and casement windows
- Partitions

Design options/safety options

- Burglar resistance up to RC3
- Bullet resistance up to FB6 S/NS

Special technical features

- Basic depth 50 mm / 58.5 mm
- Sash size up to 1475 mm × 2300 mm (W × H)
- Fixed glazing face width 30 mm
- Faceplate width 103 mm

Your benefits

- Concealed fittings for sash weights of up to 180 kg allow elegant design
- An unbeatable combination of safety and design in a non-insulated system

Section detail

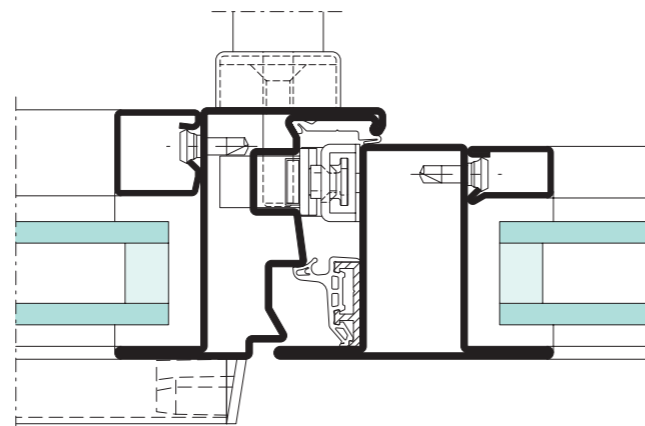

Design/safety options

Burglar resistance RC3



Bullet resistant window



System solutions for façades and roof glazing

VISS façade system solutions from Jansen offer a wide range of options for letting light into the interior, not only vertically but also for the roof.

At the same time, steel with welded joints offers design variation options. As the façades are tested on the basis of EN 13830, metal fabricators can provide the CE marking required in the EU. Safety factors such as fire and burglar resistance and sustainability can be documented through certification or EPDs.

Façades are the face of a building. They are also referred to as the building envelope or outer shell of a building. These terms are often used synonymously. However, distinctions can be made according to the type of design, function, material or construction. When it comes to the type of construction in particular, the whole spectrum is open with steel as a material: mullion/transom façades, back-ventilated hung façades, curtain walls or glass façades can be created using certified system solutions.

System solutions for façades and roofs can be found in the following series:

- **VISS Basic façade**
 - VISS Basic HI (highly insulated)
 - VISS Basic with burglar resistance
- **VISS façade**
 - VISS façade HI (highly insulated)
 - VISS façade with burglar resistance
 - VISS façade with bullet resistance
 - VISS façade with fire protection
 - VISS façade with design profiles
 - VISS façade SG (structural glazing)
- **VISS Basic roof glazing**
- **VISS roof glazing**
 - VISS roof glazing HI (highly insulated)
 - VISS roof glazing with fire protection

Symbols for the façade



Profile design, polygon glazing

The design of the façade often plays a key role in determining the appearance of a building. Attachment profiles, roof connection options or polygon glazing can all add very individual facets here. The width and depth of the profiles also play a key role, depending on how generous the views in and out are to be.

Different attachment profiles can be used to create a bespoke look and vary the play of light and shade depending on the viewing angle.

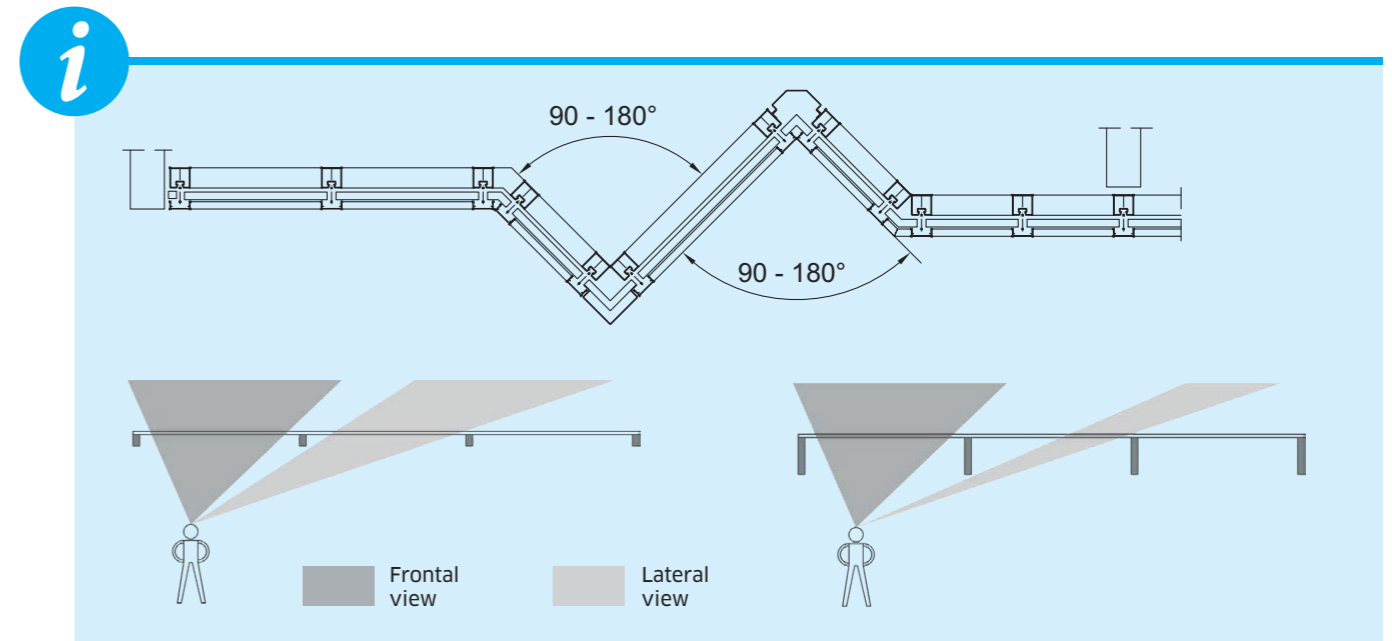

The arrangement of mullion/transom profiles or the view as an SG façade can give very different impressions to the observer.



Façade type overview

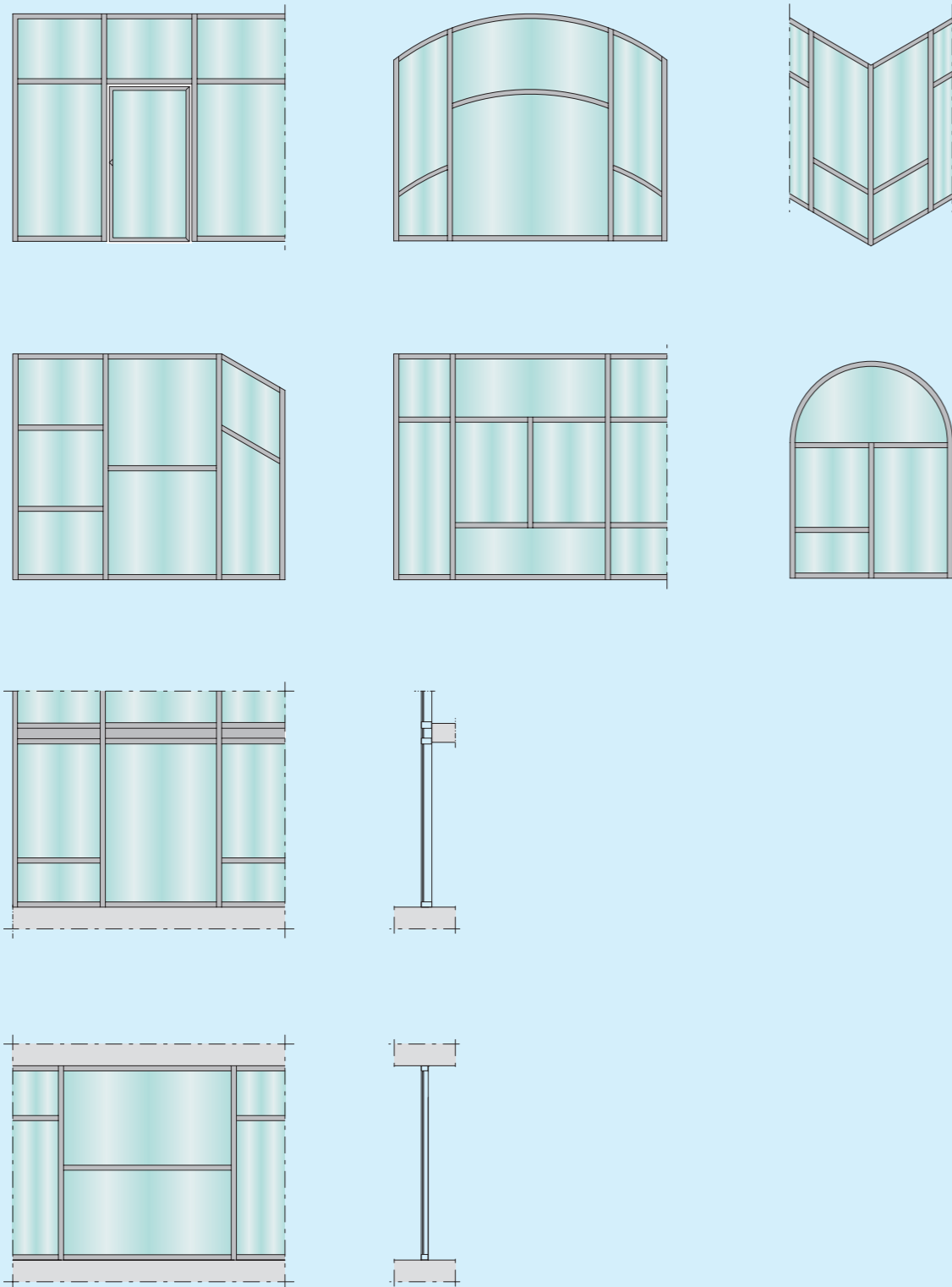

Roof glazing: Pyramid, dome, gable, mono-pitch roof

The requirements for roofs and roof glazing are diverse in form and function. This is where welded steel structures really come into their own. Filigree profiles can also be used to create large

skylights and realise complex designs. Tested inclination angles allow exact alignment according to the needs of the occupants and the specifications of the building.



Overview of roof glazing types

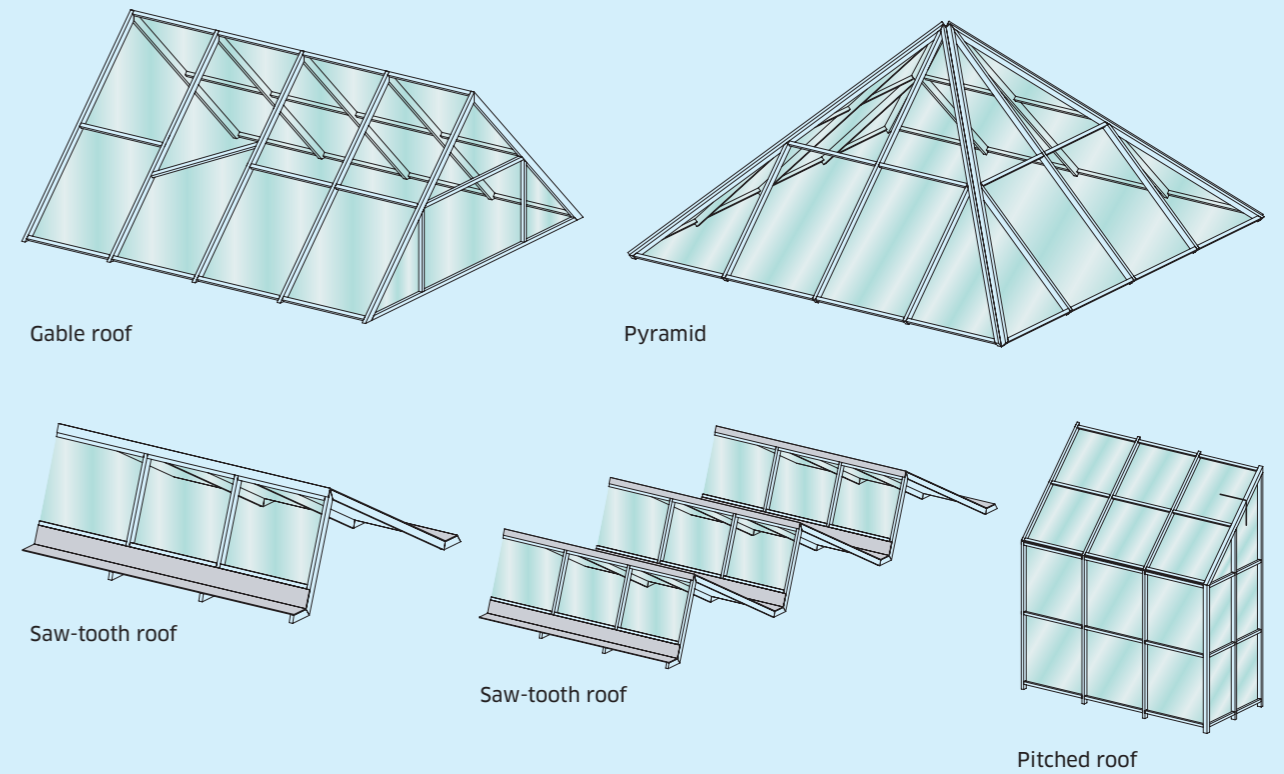

VISS Basic

VISS Basic façade

The VISS Basic façade offers architects and metal fabricators a façade construction that can be mounted on any support. The VISS façade system solution is attached to a freely selectable support structure made of standard hollow profiles. The VISS Basic façade therefore offers an ideal combination of a certified and proven system solution and a cost-effective support structure.

VISS Basic façade HI (highly insulated)

A simple insulating core as an insert is sufficient to make the VISS Basic façade highly insulated. Highly insulated means that the component makes a significant contribution to a building achieving the passive house standard. The U-value (heat transfer coefficient) specified for this is between 0.5 and 0.8 W/m²K. This value is achieved with VISS Basic Façade HI (highly insulated) in both the 50 mm and 60 mm face widths.

VISS Basic façade with burglar resistance

The VISS Basic façade can be made burglar-resistant with just a few additional components. The tested classes are RC2, RC3 and RC4, giving the façade up to 10 minutes of resistance against a well-equipped intruder. Areas of a building with limited visibility can be optimally protected.



Materials/surface finish

- Cover sections in aluminium or stainless steel

Construction types/safety options

- Mullion-mullion-transom construction
- Mullion-transom-mullion construction
- Welded and/or push-fit construction
- Segmental glazing, concave and convex
- Burglar resistance RC2/RC3/RC4
- Optimum thermal insulation with VISS Basic HI

Special technical features

- Face width 50 mm / 60 mm
- Basic depth according to structural engineering requirements
- Infill element thickness 6 mm - 70 mm

Your benefits

- CE marking according to EN 13830
- Highly thermally insulated design with U_f value from 0.51 W/m²K
- Design as SG glazing
- Combination of welded and push-fit connections for unusual shapes

Section detail

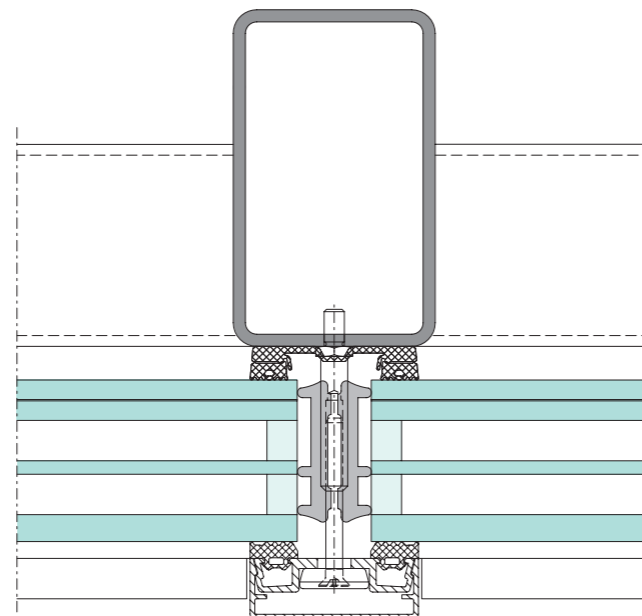

Versions of VISS Basic façade

VISS Basic façade

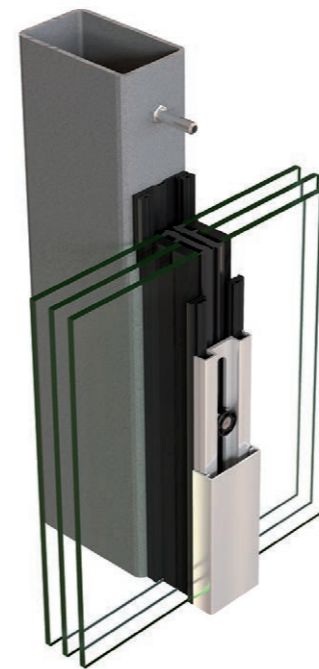

VISS Basic façade RC4

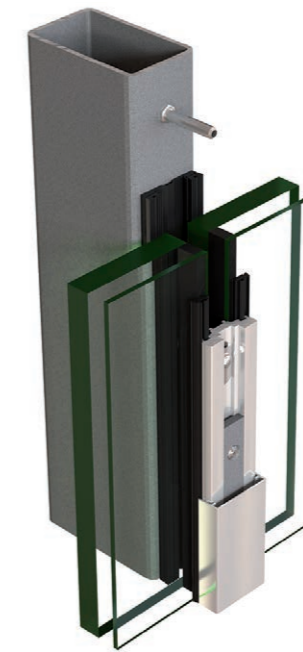

Construction types

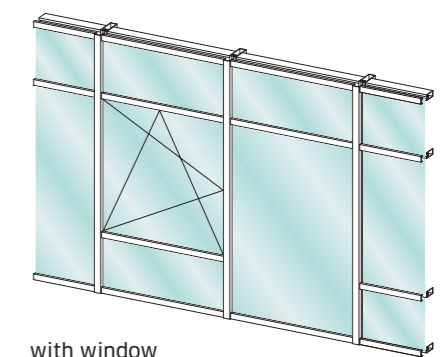

with window

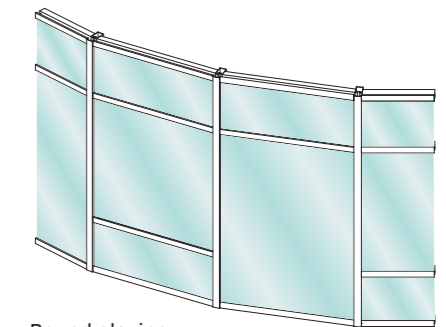

Round glazing

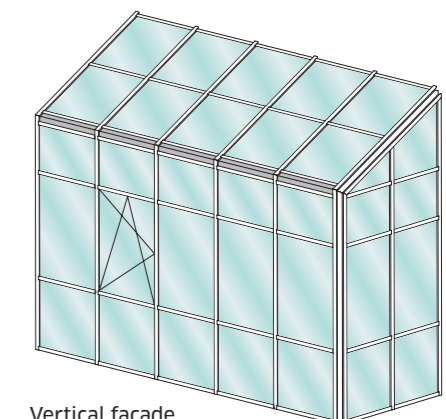

Vertical façade with pitched roof

VISS



VISS façade

The VISS façade solution from Jansen is used in both existing and new buildings. The support structure is a system solution, equipped with a special groove for mounting, making it easier to work with than a free support structure. The large spans meet the structural requirements for large-scale glass formats. At the same time, this highly thermally insulated solution is passive house certified, i.e., it meets the increasing demands for energy-efficient and energy-saving buildings. In terms of security, burglar resistance up to RC2, RC3 or RC4 or fire protection up to EI90 can be guaranteed. For special requirements, the VISS façade has even been tested against bullet impact and certified up to FB4/NS.

VISS façade HI (highly insulated)

A simple insulating core as an insert is sufficient to make the VISS façade highly insulated. Highly insulated means that the component makes a significant contribution to a building achieving the passive house standard. The U-value (heat transfer coefficient) specified for this is between 0.5 and 0.8 W/m²K. This value is achieved with VISS façade HI in both the 50 mm and 60 mm face widths. With these values, we can provide you with a passive house certificate for this façade.

VISS RC façade (burglar-resistant)

The VISS façade can be made burglar-resistant with just a few additional components. The tested classes are RC2, RC3 and RC4, giving the façade up to 10 minutes of resistance against a well-equipped intruder. Areas of a building with limited visibility can be optimally protected.

VISS façade with fire protection

In order to comply with fire regulations, the VISS façade has successfully passed several fire protection tests. This means that the façade can meet the E/EW/EI requirements for up to 30, 60 or even 90 minutes.

VISS façade SG (structural glazing)

Buildings with Jansen VISS SG or Semi-SG façades set elegant accents. Only a narrow silicone joint separates the large glass panes in this façade. The result is a uniform surface that creates a very homogeneous appearance, especially when viewed from a distance. Panes of up to 2500 mm × 5000 mm (horizontal or vertical) combined with easy implementation of all-glass corner solutions create the illusion of lightness.

Please note country-specific approvals for fire protection.

Materials/surface finish

- Uncoated or strip-galvanised steel, suitable for powder coating or stove-enamelling
- Cover sections in aluminium and stainless steel
- VISS Linea Profiles (Personal Profiles) for optical options

Construction types/safety options

- Mullion-mullion-transom construction
- Mullion-transom-mullion construction
- Welded and/or push-fit construction
- Segmental glazing, concave and convex
- Burglar resistance RC2/RC3/RC4
- Bullet resistance up to FB4
- Fire protection E/EW/EI in each case 30/60/90
- Optimum thermal insulation with VISS façade HI
- VISS façade SG (structural glazing)

Special technical features

- Face width 50 mm / 60 mm
- Basic depth according to structural engineering requirements
- Infill element thickness 6 mm - 70 mm

Your benefits

- CE marking according to EN 13830
- Highly thermally insulated design (HI) with U_{cw} value of up to 0.64 W/m²K with passive house certificate (with 50 mm face width)
- Design as SG glazing
- Combination of welded and push-fit connections for unusual shapes

Section detail

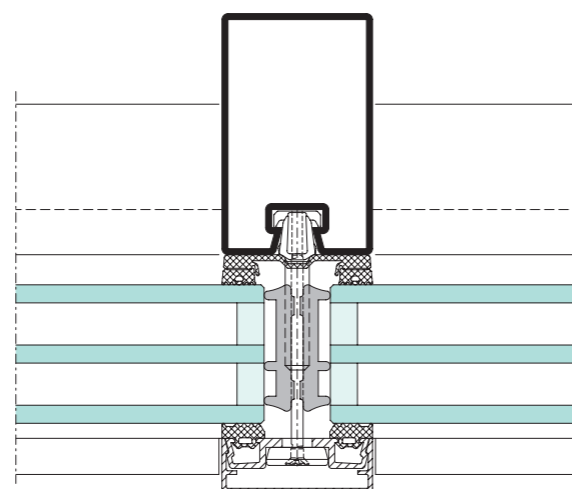

Versions of VISS façade

VISS façade

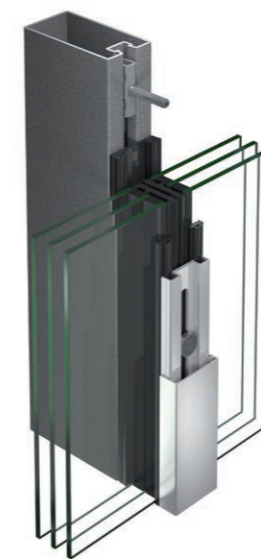

VISS façade HI

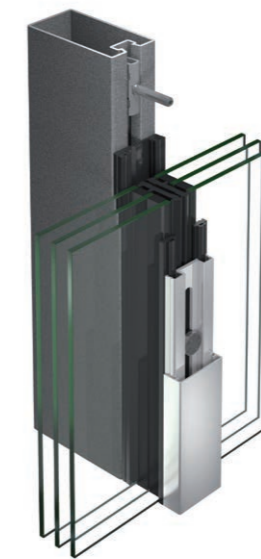

VISS façade RC

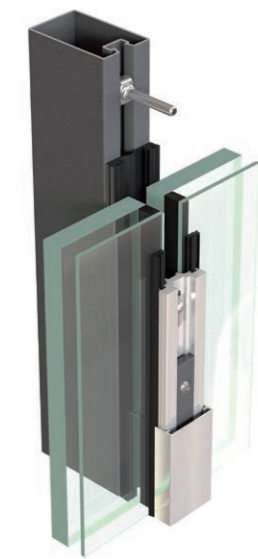

VISS Fire EI30



VISS Fire EI60



VISS façade SG

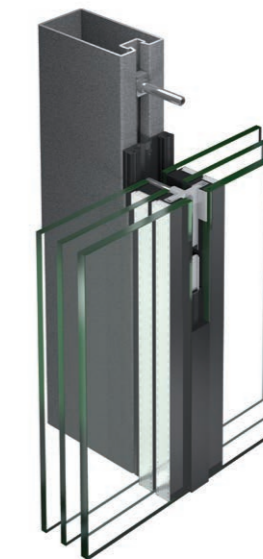

VISS façade semi SG

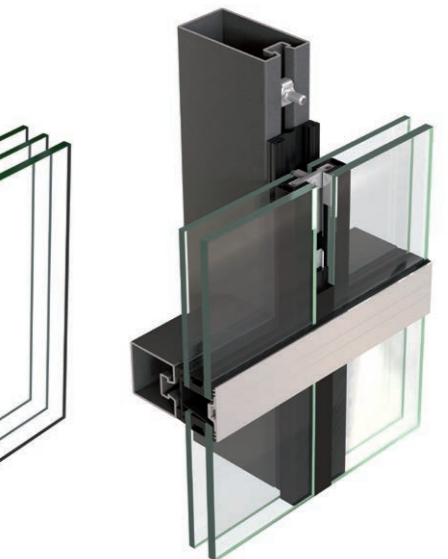

VISS Basic roof glazing

The VISS Basic roof glazing offers architects and metal fabricators a roof construction that can be mounted on any support. The free choice support profiles allow the design of large span rooflights. Another advantage of the system: the basic depth of the support profiles can be selected to meet structural engineering requirements, opening up new possibilities for the design and construction of a wide variety of roof shapes.

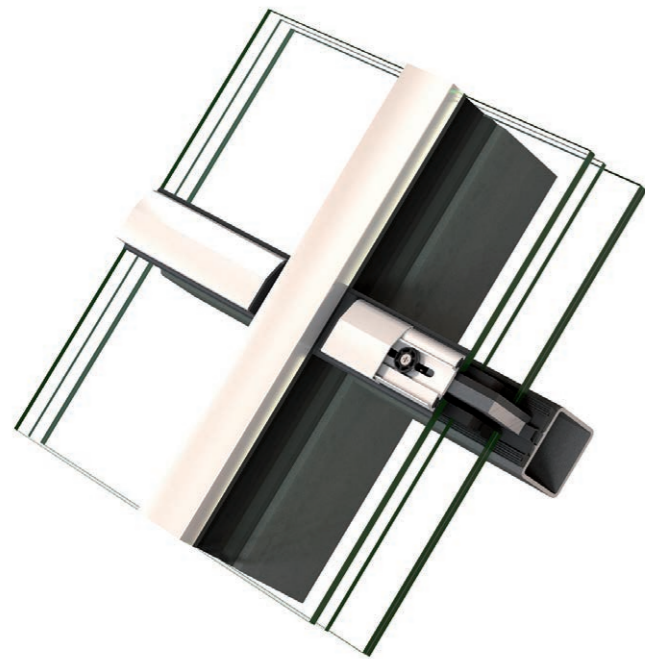

Section detail

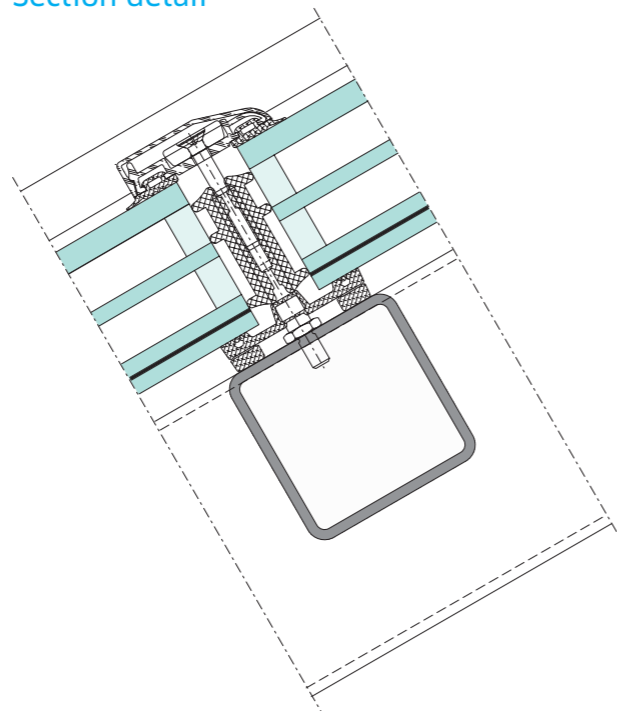

Materials/surface finish

- Cover sections in aluminium or stainless steel

Construction types/safety options

- Mullion-mullion-transom construction
- Welded and/or push-fit construction
- Pyramid, dome, gable glazing, mono-pitch roof, polygon glazing
- Optimum thermal insulation with VISS Basic roof glazing HI

Special technical features

- Face width 50 mm / 60 mm
- Basic depth according to structural engineering requirements
- Infill element thickness 16 mm - 70 mm
- Roof pitches of 7° - 80° (0° - 80° indoors, 0° - 80° on weather-protected roofs)

Your benefits

- System tested in accordance with EN 13830 (water quantity 3 l/m³ instead of 2 l/m³)
- Combination of welded and push-fit connections for unusual shapes

Versions of VISS Basic roof glazing

Construction types

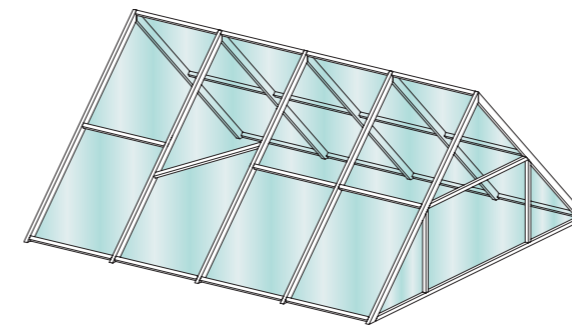

Gable roof

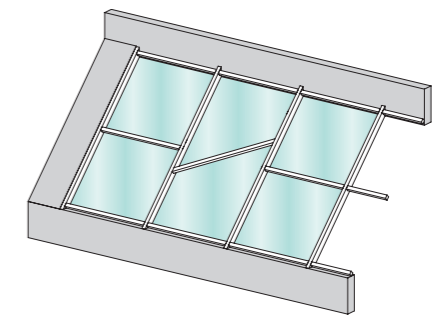

Pitched glazing

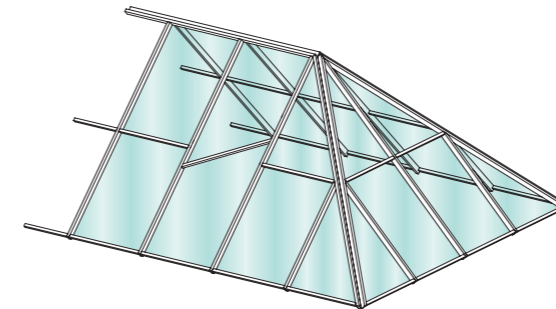

Hip roof

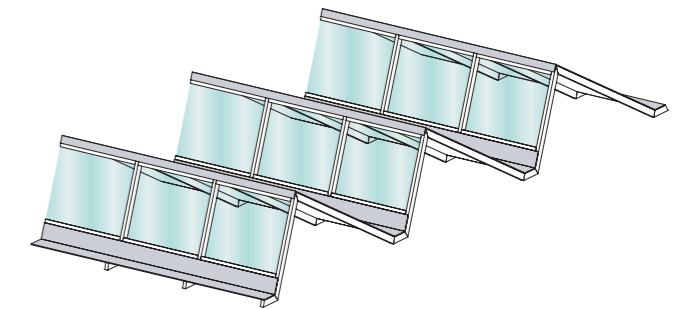

Saw-tooth roof

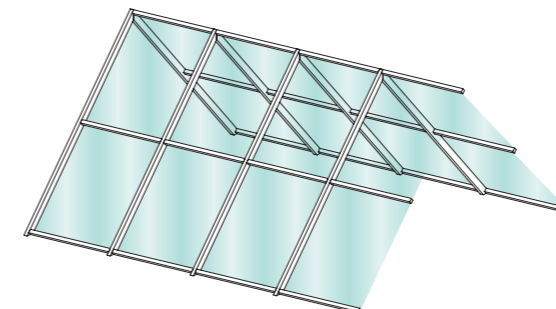

Gable roof

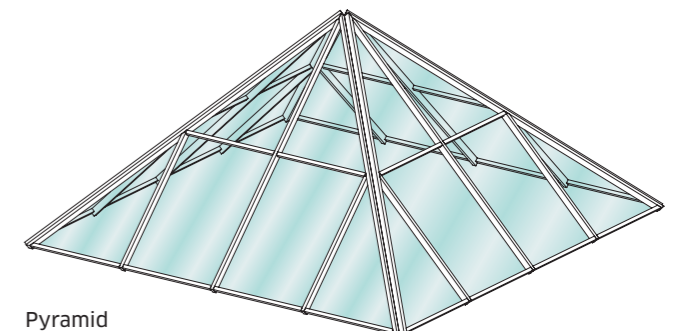

Pyramid

VISS roof glazing

The VISS roof glazing from Jansen is based on the Jansen VISS façade system solution. This means that the same face widths and depths are used vertically. The combination of the two solutions creates a flowing and easy-to-install support structure from the vertical to the slope or even to the horizontal in the interior. The large glass formats that are possible, especially with welded joints, make this particularly attractive. A special feature of VISS roof glazing is the transition from one glass thickness to another: In the same construction, this is achieved by means of just one additional, easy-to-install gasket and enables levelling of up to 10 mm.

On the outside, a highly insulating version of the Jansen VISS roof glazing is easy to achieve. Fire protection tests are a further addition for use with all roof shapes. These confirm that, in addition to the VISS façade, the VISS roof glazing also offers up to 90 minutes of protection against heat and fire.

Whether outside or inside, with or without fire protection requirements: Thanks to its versatility, VISS roof glazing offers an almost infinite range of design options. Generous light penetration turns buildings into eye-catchers.



VISS Fire roof glazing

In order to comply with fire regulations, the VISS roof glazing has successfully passed several fire protection tests according to country-specific requirements. This means that the roof glazing can meet the RE/REW/REI requirements for up to 30, 45 or even 60 minutes. A successfully passed fire test for EI30 for all types of roofs is a further addition.

Please note country-specific approvals for fire protection.



Materials/surface finish

- Uncoated or strip-galvanised steel, suitable for powder coating or stove-enamelling
- Cover sections in aluminium and stainless steel

Construction types/safety options

- Mullion-mullion-transom construction
- Welded and/or push-fit construction
- Optimum thermal insulation with VISS roof glazing HI

Special technical features

- Roof pitches of 7° - 80° (0° - 80° indoors)
- Face width 50 mm / 60 mm
- Basic depth according to structural engineering requirements 50 mm - 280 mm
- Infill element thickness 16 mm - 70 mm

Your benefits

- CE marking possible depending on the version
- Highly thermally insulated design (HI) with U_{cw} value up to 0.64 W/m²K
- Combination of welded and push-fit connections for unusual shapes

Section detail

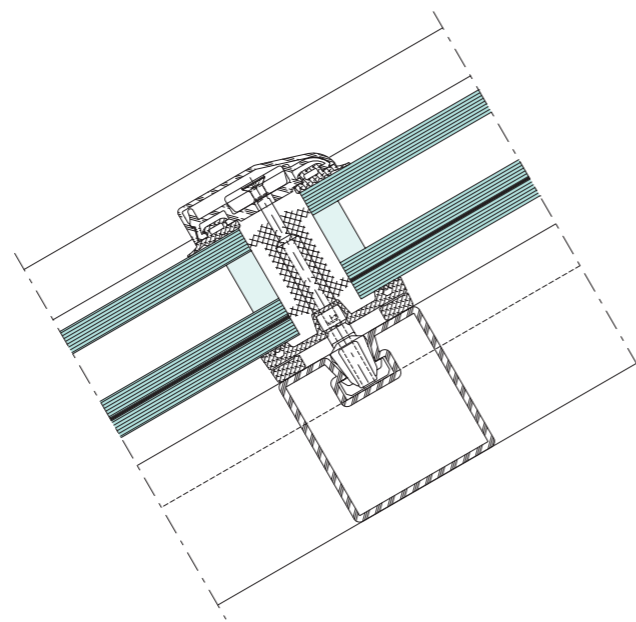

Materials/surface finish

- Uncoated or strip-galvanised steel, suitable for powder coating or stove-enamelling
- Cover sections in aluminium and stainless steel

Construction types/safety options

- Mullion-mullion-transom construction
- Welded and/or push-fit construction
- Fire protection RE/REW/REI in each case 30/45/60 or EI30

Special technical features

- Roof pitches of 7° - 80° (0° - 80° indoors)
- Face width 50 mm / 60 mm
- Basic depth according to structural engineering requirements
- Infill element thickness 16 mm - 70 mm

Your benefits

- CE marking possible depending on the version
- Combination of welded and push-fit connections for unusual shapes

Section detail

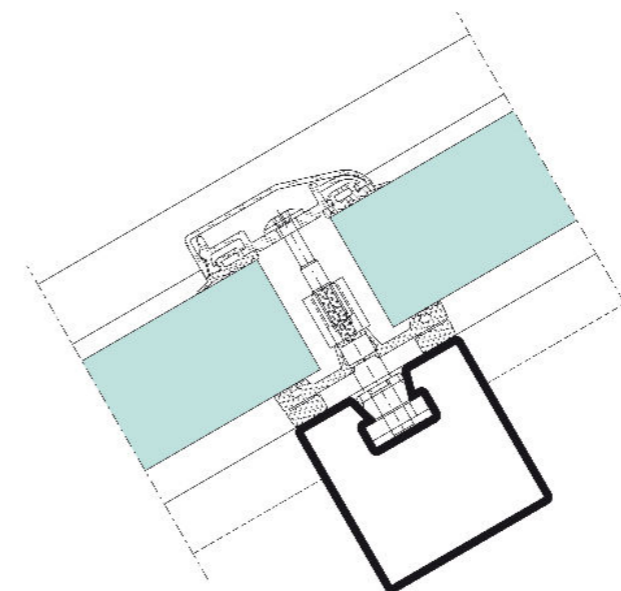

Folding and sliding doors

Redefining the experience of space: Whether in private homes or public buildings, in the building envelope or as a room divider, there is no more space-saving way to combine opening and light.

Large sliding systems and flexible folding wall systems create a unique, airy room ambience. They provide a stylish connection to the outside while keeping out noise and odours with full transparency.

Smooth operation and quiet operation are tested, as are barrier-free threshold solutions and burglar resistance.

Sliding and folding doors are generally defined by the way the weight is distributed, which, unlike a side-hung door, does not affect one side, but is absorbed on the top or bottom. They are used where face-fitted doors take up unnecessary space and offer formats that are too large for single-sided hanging with conventional side-hung doors. For lift-and-slide systems, the type of opening is referred to as a scheme, which is labelled with letters. This indicates which parts of the structure are movable and which are fixed, or in which direction they move.

System solutions for folding and sliding systems can be found in the following series:

- Janisol lift-and-slide door
- Janisol folding wall
- Janisol Arte 2.0 sliding door
- Janisol 2 EI30 fire-resistant sliding door



Opening types

Sliding door

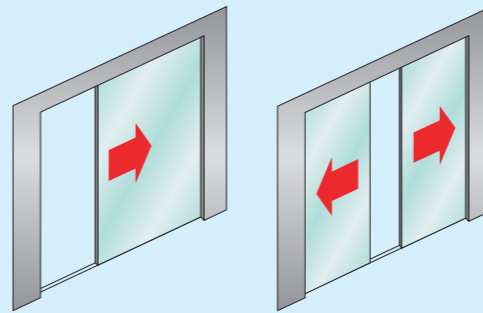

Folding sliding door

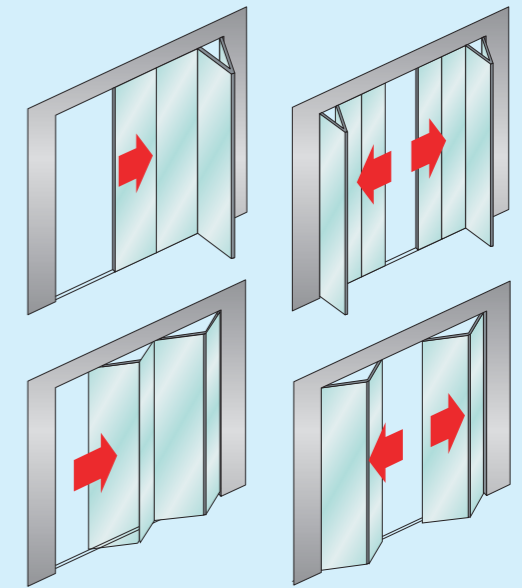

Examples of opening types from the outside

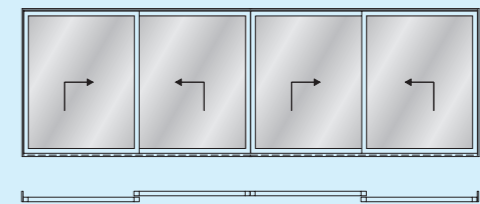
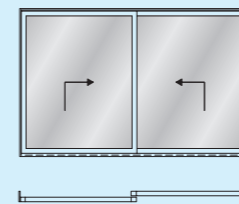
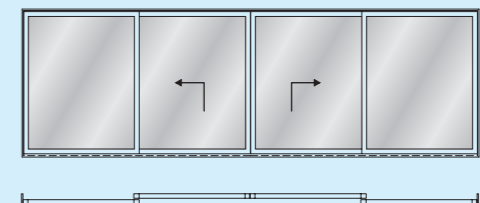
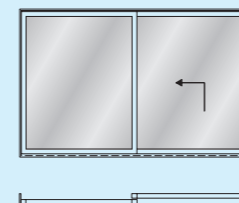
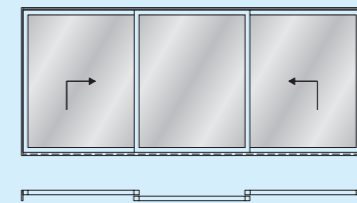

Janisol lift-and-slide door

Thermally insulated lift-and-slide doors from the Janisol system solution offer narrow face widths combined with maximum functionality and safety/security. The lifting mechanism presses the gasket into place when the door is closed, resulting in an exceptionally tight door, which is reflected in the Janisol lift-and-slide door's excellent resistance to, for example, driving rain.

In high-rise buildings, steel is a particularly resilient material: the higher the building, the greater the suction and wind loads. Due to the strength of the material, the deformation is minimal and the material returns to its original state. In increasingly densely populated cities, living space is precious: Buildings are getting taller and living spaces smaller. Sliding systems that can withstand the elements and yet take up minimal space are therefore an ideal solution. Minimum face widths and infill units up to 57 mm ensure a comfortable interior while allowing light to enter.



Materials/surface finish

- Uncoated steel or strip-galvanised steel, suitable for powder coating or stove-enamelling

Element types

- Two, three and four leaf lift-and-slide windows, with and without fixed elements ((scheme A, C, D, F, K) see next page)

Design options/safety options

- Burglar resistance RC1N to RC2
- Motorised version

Special technical features

- Leaf size up to 3310 mm × 3200 mm
- Frame face width incl. leaf 113.5 mm
- Special solution up to 600 kg/leaf

Your benefits

- System solution with CE marking
- Different panel sizes

Section detail

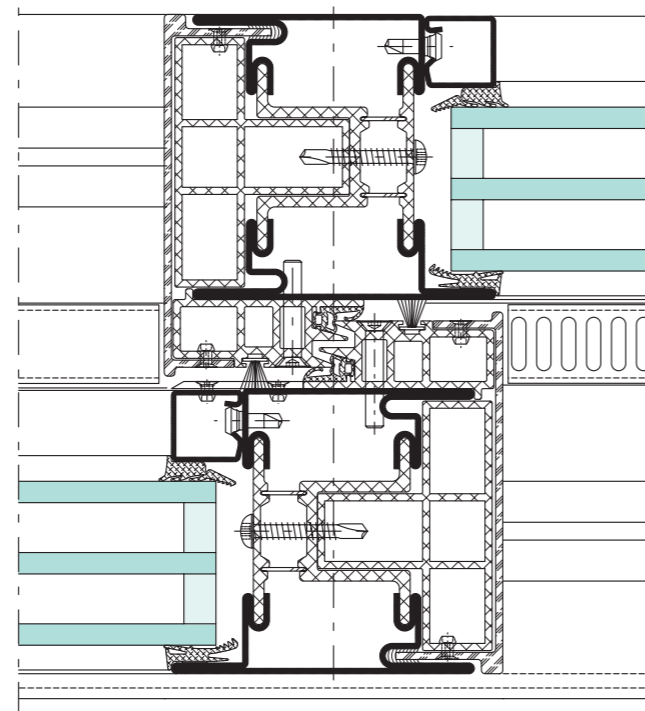

Design/safety options

Burglar resistance RC 1-2

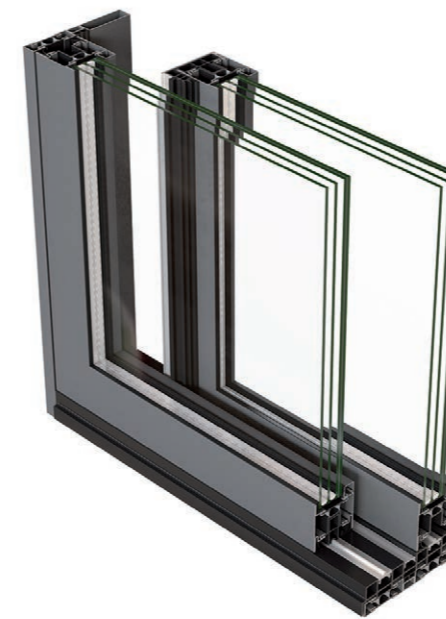

Motorised Janisol lift-and-slide door



Element types

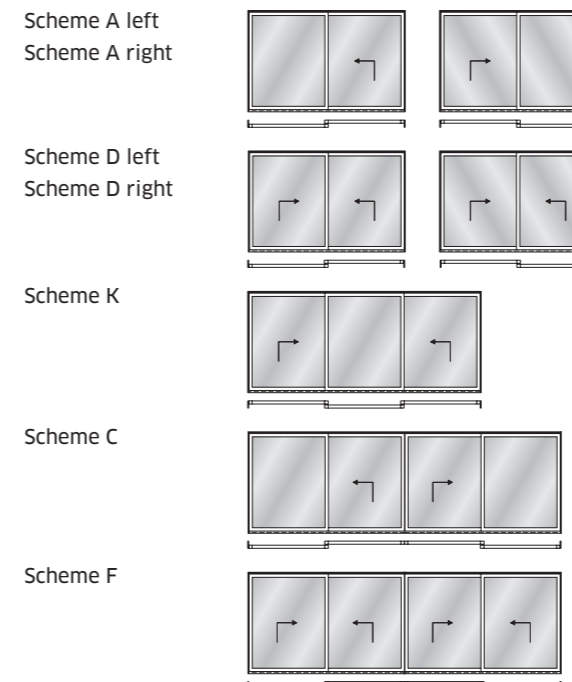

Motorised version

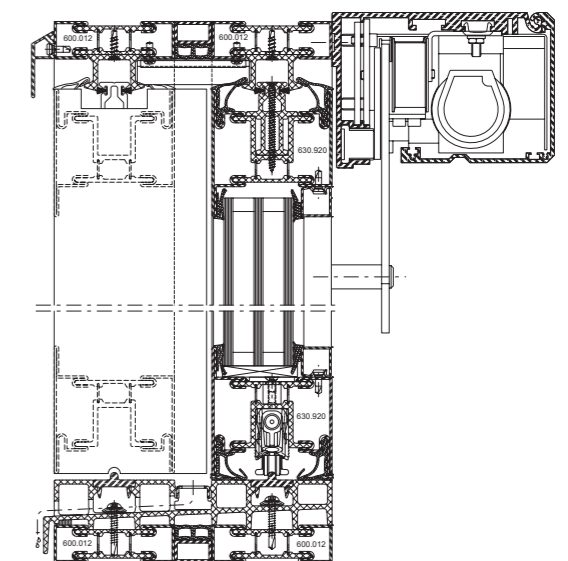

Janisol Folding partition

The Janisol folding partition is based on the tried-and-tested Janisol system. A folding partition can save and easily open up space, both indoors and outdoors. The individual panels are pushed together on rails and stowed to the side to save space. Depending on the space available in the side area, a wide variety of combinations are possible. Either all the leaves move to one side or they are evenly distributed - and there are plenty of options in between. The Janisol folding partition is thermally insulated and easy to operate. Very good values, for example for watertightness or sound insulation, make it a living companion, both indoors and outdoors.



Materials/surface finish

- Uncoated steel or strip-galvanised steel, suitable for powder coating or stove-enamelling

Element types

- Two to six leaves can be folded inwards or outwards (see next page)

Design options/safety options

- Barrier-free folding door

Special technical features

- Basic depth 60 mm
- Leaf size up to 1000 mm x 2900 mm
- Frame face width incl. leaf 82.5 mm
- Faceplate width 10 mm

Your benefits

- CE marking
- Any leaf layout

Section detail

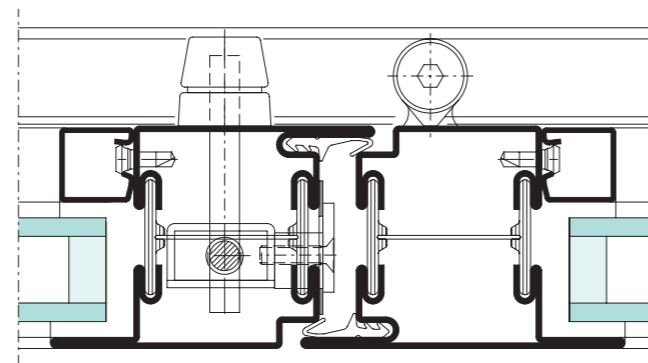

Design/safety options

Element types

2+0



3+0

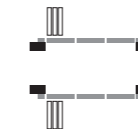

2+1

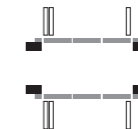

3+1

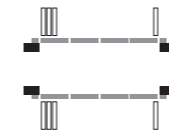

2+2

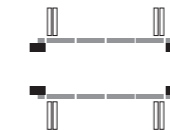

4+0

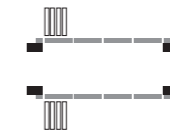

5+0

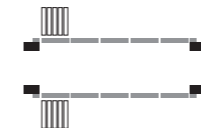

4+1



3+2



5+1

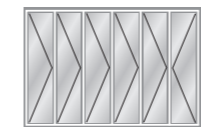

3+3

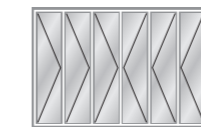

6+0

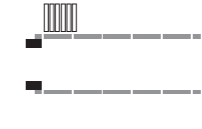

Janisol Arte 2.0 sliding door

The extremely delicate Janisol Arte steel profile system can be used to create large sliding doors with narrow face widths and high stability. Originally developed by Jansen for the reconstruction of historic windows, Janisol Arte now also offers architects and planners the opportunity to structure large glass fronts in new buildings.



Section detail

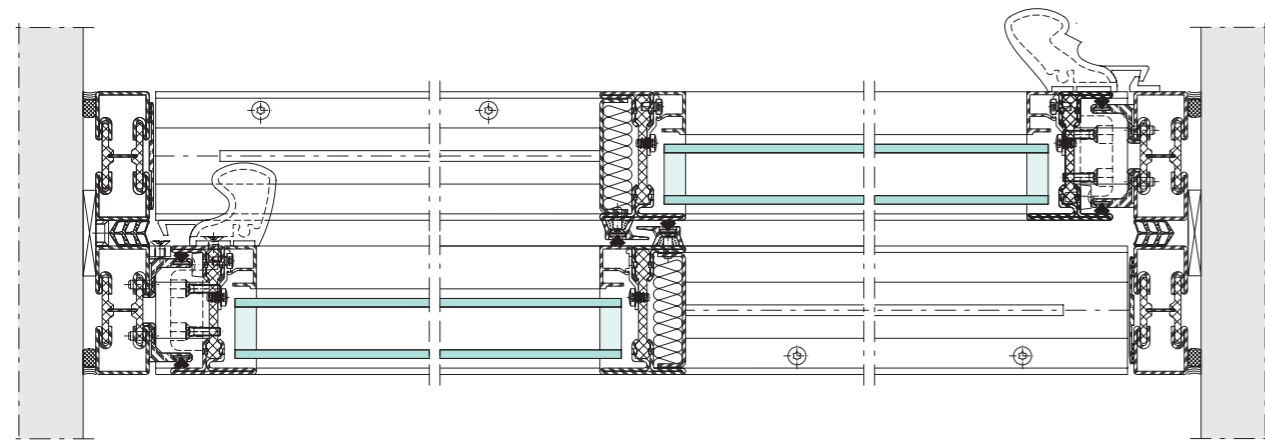

Materials/surface finish

- Strip-galvanised steel, suitable for powder coating or stove-enamelling
- Stainless steel 1.4401
- Corten

Element types

- Double leaf sliding door with left or right stop

Design options/safety options

- Barrier-free folding door

Special technical features

- Insulating glazing from 20 mm - 34 mm
- Leaf size up to 1500 mm × 2500 mm
- Max. leaf weight 150 kg/leaf
- Sound insulation up to 41 dB

Your benefits

- CE marking
- Available in all materials (steel, stainless steel, Corten) from stock



Janisol 2 EI30 fire-resistant sliding door

The Janisol 2 EI30 fire-resistant sliding door is used in high-traffic barrier-free buildings such as shopping centres, stadiums or administrative buildings. The automatically opening door system has been successfully tested to EN 1634 fire resistance class EI30, with or without an integrated escape door function and with a wide range of drive motors, glass inserts and panels.

Please note country-specific approvals for fire protection.

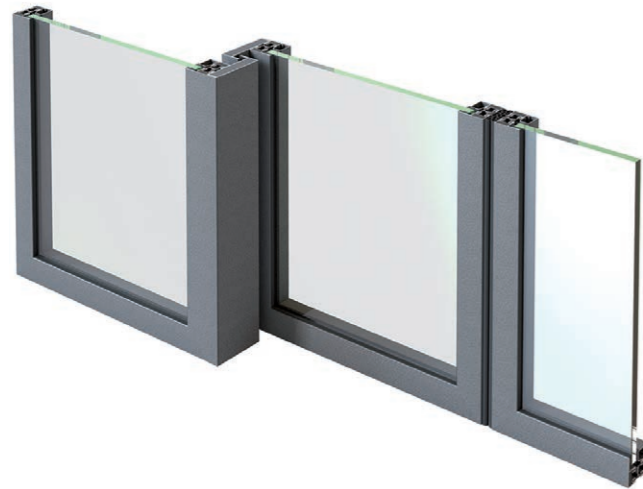

Section detail

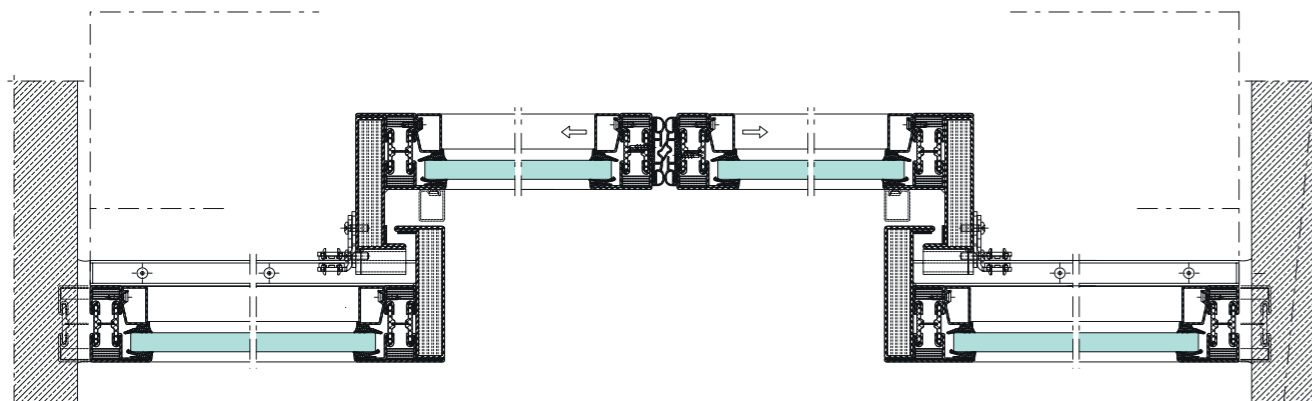

Materials/surface finish

- Uncoated steel or strip-galvanised steel, suitable for powder coating or stove-enamelling

Element types

- Single and double doors, with and without fixed side lights or top lights

Design options/safety options

- Emergency exit door
- Fire protection door
- Break-in or break-out function
- Barrier-free door

Special technical features

- Basic depth of window leaf 90 mm, fixed glazing 80 mm
- Leaf size e.g. 1400 mm × 2500 mm (without integrated escape door function)
- Faceplate width from 115 mm

Your benefits

- Multiple safety/security applications can be combined in one system
- Full automation enables contactless access
- CE marking by drive supplier possible

Design/safety options

Break-out function closed

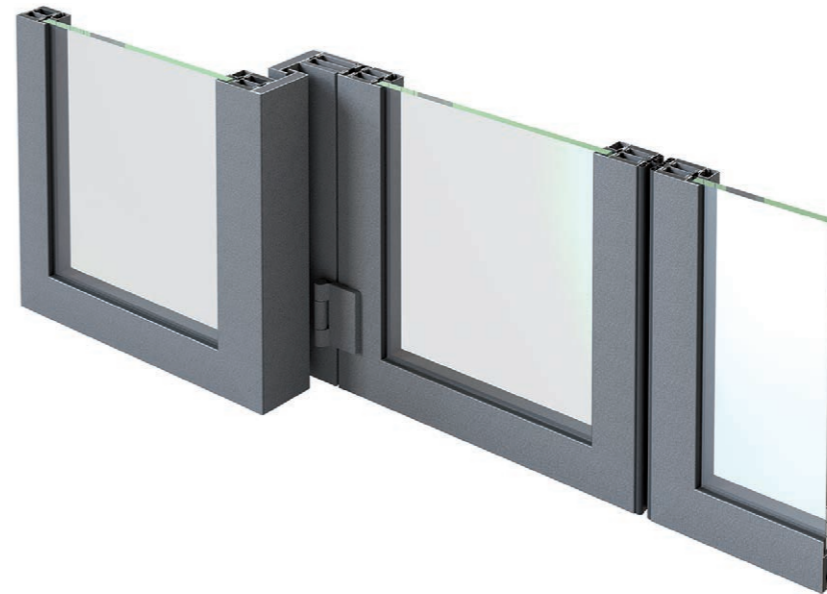

Barrier-free

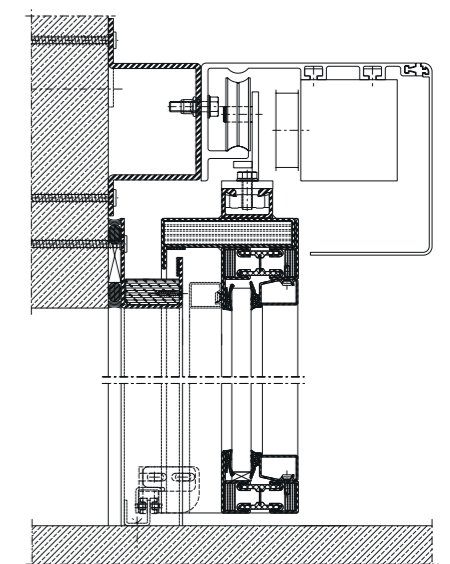

Break-out function open

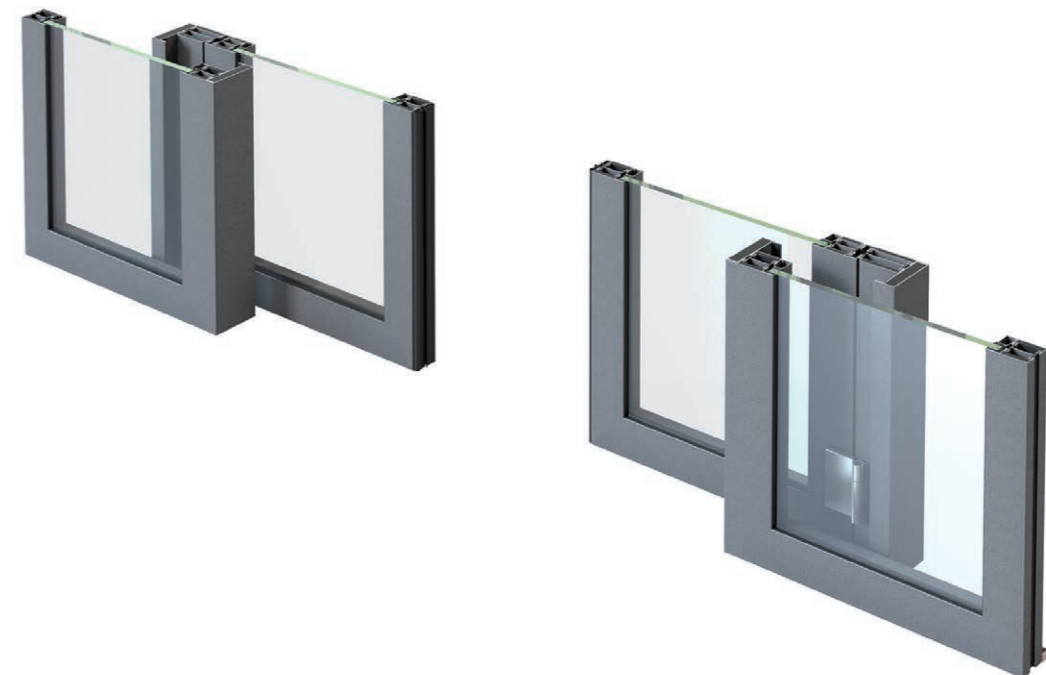

Additional services by Jansen

Jansen offers its customers services and digital solutions for every step of the value chain.

Digital solutions:

- BIM: The origin of digital planning
- Virtual showroom: The inspiration behind our solutions
- JANIsoft/LogiKal: The software calculation and design solution
- Jansen Docu Centre: All information in one place
- CAD: The drawing editing software for technical drawings
- Machine control: Digital system control using software

Services:

- System consulting: Support within system solutions
- Custom engineering: Support outside the system solution
- Training Department: Knowledge transfer of our product & system solutions
- Service centre: Hotline support for all aspects of our digital products
- Range of machines: The right systems for production
- Workshop planning: Support for planning automated production
- After sales: Sales and material order processing
- Maintenance kit: The right equipment for element maintenance

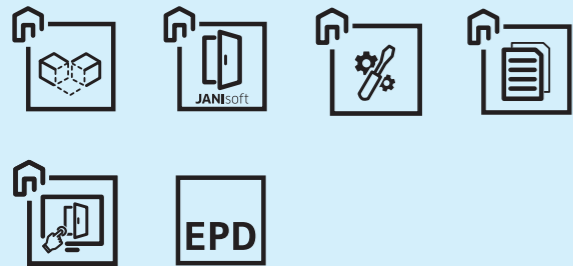

Advantages of steel

Sustainable

The CO₂ footprint of a building can be reduced with the use of steel. Steel requires significantly less process energy during production compared to alternative materials. The material is also extremely robust and durable. As a result, steel profiles require little maintenance and replacement over time. At the end of its life cycle, steel can be recycled indefinitely without adding other materials and without losing quality. In our EPDs, these advantages of steel are included in the evaluation. Steel is therefore the material most likely to meet the requirements of the 'Green Deal'. Jansen steel profiles score with a CO₂ value of 1.6 kg CO₂/kg steel.

Noble, filigree and versatile

Whether in new buildings or renovations, steel allows design freedom like no other material. Thanks to the strength of the material, extremely slim profiles can be processed which, despite their filigree structure, can support large glass elements. This creates maximum transparency and incidence of light, blurring the boundaries between interior and exterior spaces. With material variants such as stainless steel or Corten, steel offers further design options to create a unique room ambience. In addition, steel can be shaped extremely freely, which creates additional design freedom. In short: steel brings functionality and design into harmony.

Safe

Steel is inherently more fire resistant than other materials, which makes it a safe choice for windows, doors and façades where fire protection is key. We therefore offer fire-tested systems up to EI90, which include all elements such as glass, hinges, fittings, and accessories. Due to its strength, steel is also the ideal solution for burglar and bullet resistance. As a result, Jansen steel systems are often used when buildings must meet high security standards. This is the case, for example, with parliament buildings, museums, banks, or penitentiaries.





BIM (Building Information Modelling)

Monitoring the entire life cycle of a building

BIM is becoming increasingly popular with architects and designers. In order to meet the needs of BIM users, Jansen offers the Jansen door and window systems as well as the VISS façade systems with Janisol insert elements and VISS HI with Janisol HI insert elements as 3D models for use in digital building models on its website and on the BIMobject platform. These contain information on both geometry and product data. The BIM models are available as a free download for Revit and ArchiCAD.

Advantages

- Direct Autodesk® Revit interface with the JANIssoft planning software
- Detailed visualisation in 3D
- Planning security thanks to precise calculations
- Fault detection as early as the planning phase
- Transparent cooperation with all parties involved
- Comprehensive information on Jansen steel systems

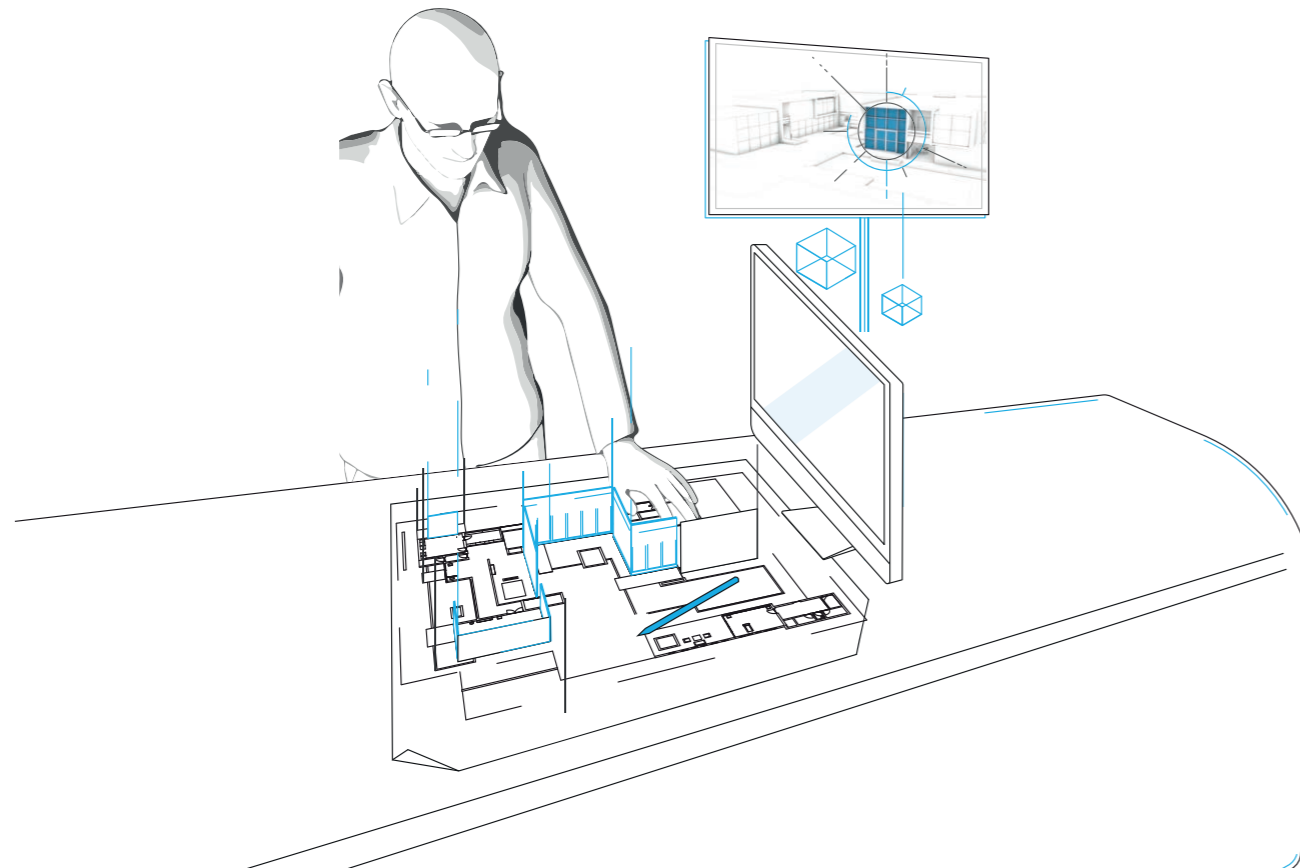

JANIssoft planning software

Quick and easy customised solutions

JANIssoft enables the professional planning, calculation and digital design of Jansen systems for doors, windows, façades and sliding systems. With JANIssoft, planners and fabricators can easily create quotations and orders with the corresponding detailed drawings and calculations.

The program interface has a modern look. It is easy and intuitive to use, and calculations can be made quickly.

Optimised software functions enable the process to be designed efficiently, from production planning and manufacturing to machine control. JANIssoft is available in three versions: 'basic', 'advanced' and 'enterprise'. In addition to the standard version for calculation and order processing, the last two versions mentioned include additional practical functions.



Advantages

- 2D and 3D designs for doors, windows and façades
- 3D visualisation with high-resolution details
- Direct transfer of profile sections to CAD
- Interface to PPS and ERP systems for transfer of results
- Comprehensive technical and commercial data on Jansen system products
- Automatic calculations for statics, U-values and prices
- Static pre-dimensioning for snow and wind loads
- Practical templates for all profile systems
- Simple cutting optimisation
- User-guided hardware selection according to catalogue
- Creation of machine and sawing data
- Interface with Revit and IFC formats for Jansen BIM models



Machine control

Machine control with JANIssoft

You can process a selection of steel systems with the JANIssoft machine control. The processing data is transferred to the machines in a data exchange file.

All profile processing activities can be displayed in advance in 3D processing mode and can be adjusted to suit the customer's requirements. The intended processes can be checked in advance using JANIssoft in the office or on the production floor. Jansen metalworking machine control supports different saw types and profile machining centres.

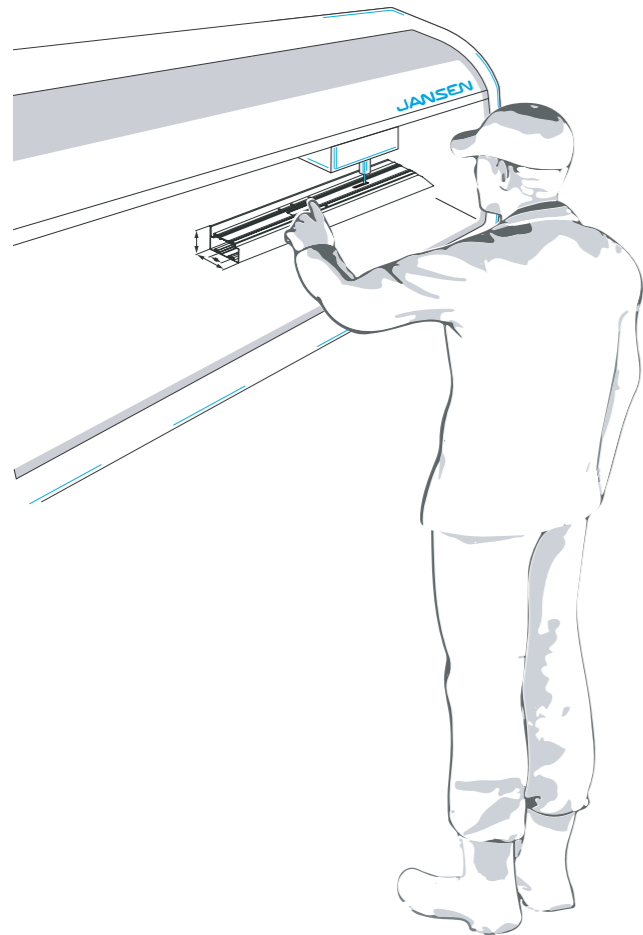

Product advantages

- Product advantages
- Unit entry and production planning in one software solution
- Automatic calculation of profile processing work
- Processing mode visualised in 3D
- Processes can be easily adapted to suit the customer's special requirements

Fabrication benefits

- Error prevention through visualisation of the fitting components and processes in 3D
- Automatic wall recognition reduces fabrication time
- Optimum interaction with machines using just one exchange file
- Faster entry for customer-specific profile processes due to processing lists
- Displaying and dimensioning the processes reduce errors
- Serial processing for fast entry of repeat processes



JANSEN Docu Centre

The Jansen Docu Centre is a central digital platform where we provide our customers and partners with detailed information about our products, articles and services in a structured and clear format. Best of all - the data is always up to date.

In addition to the web applications, you can also use the app on your smartphone or tablet.

Searching for information is now a thing of the past. With the Jansen Docu Centre you will find all the information you need (catalogues, forms, videos, etc.).



What can you find in the Jansen Docu Centre?

In the Jansen Docu Centre you will find information about the Jansen steel systems and the Jansen Connex system:

- Catalogues and documentation
- Fabrication and installation guidelines and videos
- Data sheets (factory certificates, safety data sheets, etc.)
- CAD library
- Tools
- CE marking
- EPDs
- Archive



JANSEN virtual showroom

The virtual showroom provides an intuitive and easy way to visualise units, products and more in a photo-realistic way, e.g. in their natural environment.

It essentially consists of four components.

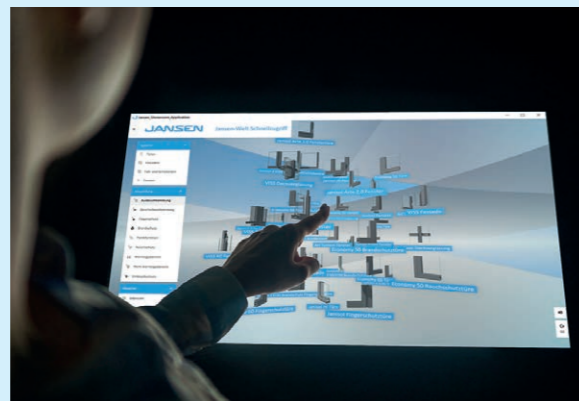

Product overview:

There is a tile for each product in the product overview. After clicking on the tile, you can select the option 'Product information' or 'Explosion animation'. This makes it possible to show even more than is possible with a physical product, because the explosion shows the individual parts of the element and can also be zoomed in to focus on individual items.

Design configurator:

Windows, doors and façades can be modified here to have different colours, profiles or fittings. They can also be placed in different environments to show how they would look in certain architectural styles. The design configurator offers over 1 million possible combinations of colours, fittings, glazing beads and environment options.

Favourites:

You can combine your own favourites in this tile. This can be used to prepare for visiting customers, for example.

Safety/security applications:

The safety/security applications tile uses animations for various safety and security requirements to explain what test scenarios the element will be subjected to and what the resulting certification will look like. This is currently possible for fire, smoke and burglar resistance as well as wind, water and air tests.

Design in the application:

In the future, this tile will contain animations related to products that make work easier for the metal fabricator or investor.



EPDs

EPDs are required for building certifications such as Leed or Breeam. They are issued for building components. Typically, certified EPDs are created for a standard window, a standard door or a defined number of square metres of façade and can be converted to the number/size of elements in a building if required.

You can request LCAs (Life Cycle Assessments) for properties from us. LCAs show exactly the same values as an EPD, but the document is not independently verified separately. For the LCAs, Jansen uses a pre-verified tool whose values and rules have been independently tested and confirmed.



Values shown in the EPDs:

- Scarcity of abiotic resources (air, mineral resources, metal ores, fossil fuels)
- Acidification of soil and water
- Ozone depletion
- Global warming
- Eutrophication (accumulation of nutrients)
- Photochemical ozone formation (change in the concentration of ozone at ground level)

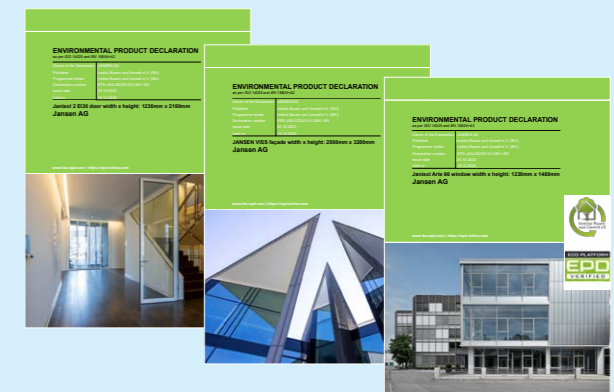



If this document differs from the current German version (article No. K1016987), the German original text in its current version in the Jansen Docu Center applies in any case.

K1016982 | Steel Systems | 06/2024 | Subject to change without notice

Jansen AG

Steel Systems
Industriestrasse 34
9463 Oberriet
Switzerland
jansen.com

JANSEN