

Jansen-Economy 60 Türen

Türen aus Stahl

Portes Jansen-Economy 60

Portes en acier

Jansen-Economy 60 doors

Doors in steel

Grafische Planungsdaten wie z.B. Anwendungsbeispiele, Konstruktionsdetails, Anschlüsse am Bau, die in unseren physischen oder elektronischen Dokumentationsunterlagen enthalten sind, sind schematische Darstellungen. Gleiches gilt für digitale Medien wie CAD Dateien oder BIM Modelle.

Sie sollen den ausführenden Metallbauer und/oder Fachplaner bei der Planung und Ausführung eines Projektes unterstützen. Sie sind im konkreten Anwendungsfall durch den ausführenden Metallbauer und/oder Fachplaner auf die Verwendbarkeit im konkreten betroffenen Projekt hinsichtlich rechtlichen/regulatorischen aber auch technischen objektspezifischen Anforderungen zu überprüfen und ggfs. eigenverantwortlich anzupassen.

Bei der Überprüfung, der spezifischen Planung und der Umsetzung sind die objektspezifischen Rahmenbedingungen (Material der Bausubstanz, Dimension des Einbauelements, Farbe, Exposition, Lasteinwirkung, etc.) sowie der geltende Stand der Technik einschliesslich aller anwendbaren Normen und technischen Richtlinien eigenverantwortlich zu beachten.

Falls das vorliegende Dokument Differenzen zur aktuellen deutschen Version (Artikel Nr. K1214237) aufweist, gilt in jedem Fall der deutsche Originaltext in der jeweils geltenden Fassung im Jansen Docu Center.

Alle Ausführungen dieser Dokumentation haben wir sorgfältig und nach bestem Wissen zusammengestellt. Wir können aber keine Verantwortung für die Benutzung der vermittelten Vorschläge und Daten übernehmen. Wir behalten uns technische Änderungen ohne Vorankündigung vor.

Les données de planification graphiques, comme les exemples d'application, détails de construction et raccordements au bâtiment, fournies dans notre documentation physique et numérique sont des représentations schématiques. Il en va de même pour les médias numériques comme les fichiers CAD ou modèles BIM.

Leur but est de faciliter la planification et réalisation d'un projet par les constructeurs métalliques et/ou concepteurs. Concrètement, elles doivent être vérifiées par le constructeur métallique et/ou le concepteur et, le cas échéant, modifiées de son propre chef pour s'assurer qu'elles concourent avec le projet concerné et qu'elles répondent aux exigences techniques spécifiques ainsi qu'aux dispositions légales et réglementaires.

Lors de la vérification, de la planification spécifique et de la mise en œuvre, il y a lieu de tenir compte des conditions spécifiques à l'objet (matériaux du bâtiment, dimension de l'élément d'insert, couleur, exposition, effet de charge, etc.) ainsi que de l'état actuel de la technique, y compris toutes les normes et directives techniques applicables.

En cas de divergence entre le présent document et la version allemande (no d'article K1214237), c'est dans tous les cas le texte original allemand qui prévaut dans sa version actuelle disponible dans le Jansen Docu Center.

Nous avons apporté le plus grand soin à l'élaboration de cette documentation. Cependant, nous déclinons toute responsabilité pour l'utilisation faite de nos propositions et de nos données.

Nous nous réservons le droit de procéder à des modifications techniques sans préavis.

Graphical planning data such as application examples, construction details, connections on site that are contained in our physical or electronic documentation components are schematic representations. The same applies to digital media such as CAD files or BIM models.

They are intended to support the metal worker and/or design engineer in planning and executing projects. In the specific case of application they are to be checked by the metal worker and/or design engineer in terms of their usability in the specific project concerned with regard to legal/regulatory and technical property-specific requirements and adjusted if necessary at the latter's own responsibility.

The property-specific underlying conditions (construction material, dimensions of installation element, colour, exposure, load effect etc.) and current state of the art including all applicable norms and technical guidelines are to be taken into consideration at the metal worker and/or design engineer's own responsibility during the review, specific planning and implementation.

If there are any differences between this document and the current German version (item number K1214237), the latest version of the original German text in the Jansen Docu Center shall prevail.

All the information contained in this documentation is given to the best of our knowledge and ability. However, we decline all responsibility for the use made of these suggestions and data.

We reserve the right to effect technical modifications without prior warning.

Inhaltsverzeichnis Sommaire Content	Jansen-Economy 60 Türen Jansen-Economy 60 portes Jansen-Economy 60 doors	2	
Systemübersicht Merkmale Leistungseigenschaften Systemausführungen Typenübersicht	Sommaire du système Caractéristiques Caractéristiques de performance Exécutions de système Sommaire des types	Summary of system Characteristics Performance characteristics System versions Summary of types	2
Profilsortiment	Assortiment de profilé	Range of profiles	14
Beispiele Schnittpunkte Konstruktionsdetails Anschlüsse am Bau	Exemples Coupes de détails Détails de construction Raccords au mur	Examples Section details Construction details Attachment to structure	18
Leistungseigenschaften	Caractéristiques de performance	Performance characteristics	36







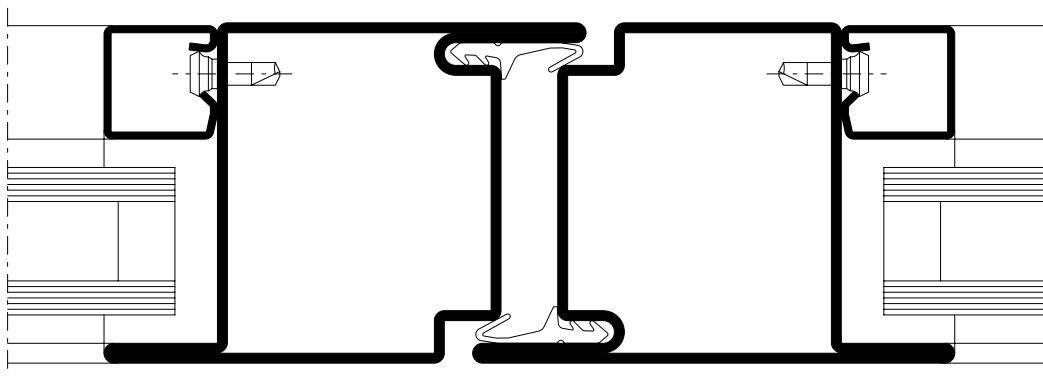

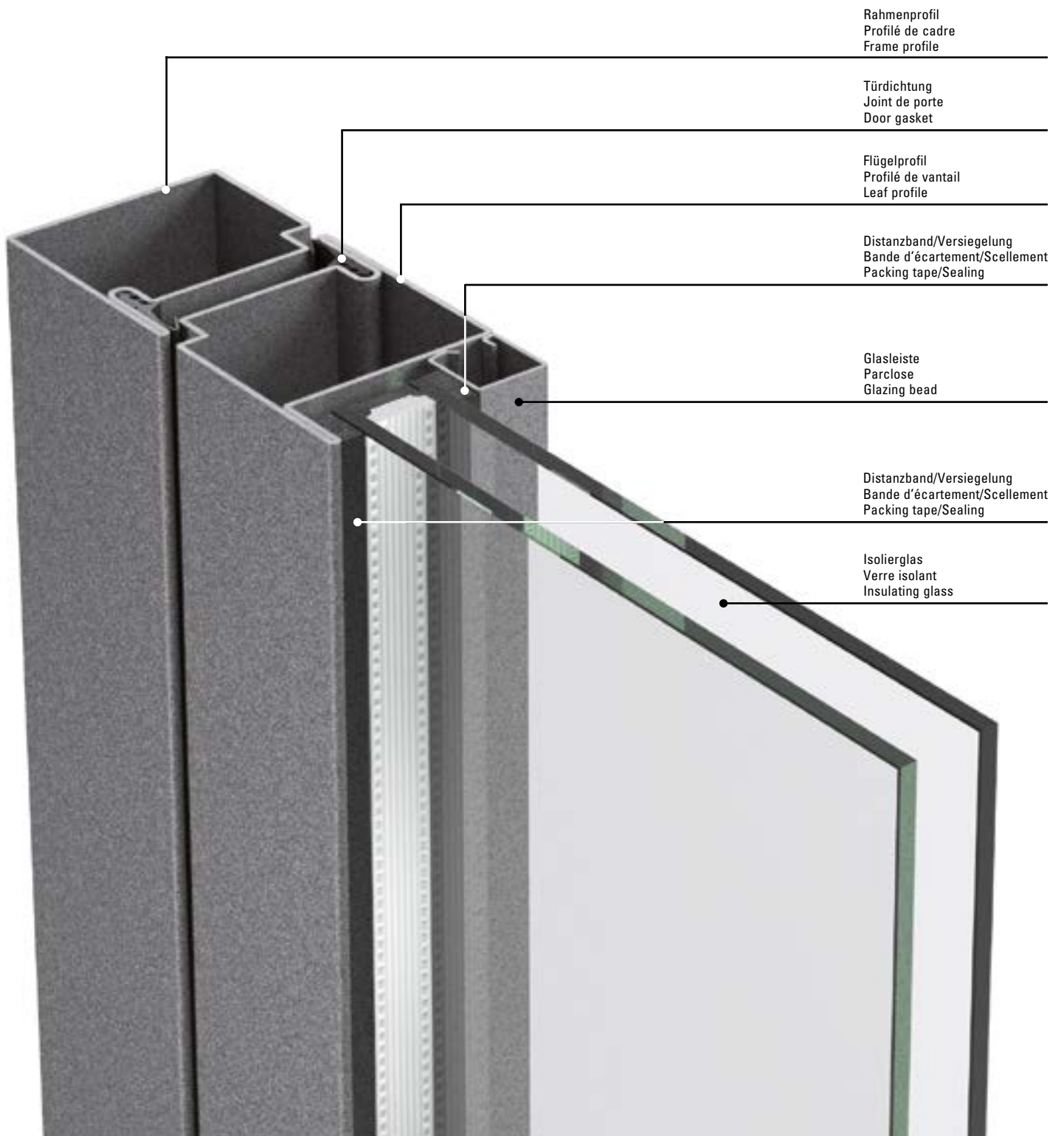

Merkmale
Caractéristiques
Characteristics

Jansen-Economy 60 Türen
Jansen-Economy 60 portes
Jansen-Economy 60 doors

- Stahlsystem für Türen und Festverglasungen
 - Bautiefe 60 mm, innen und aussen flächenbündig
 - Schmale Ansichtsbreiten: Rahmen und Flügel ab 105 mm Stulppartie 150 mm
 - Ein- und zweiflüglige Türen, nach innen und aussen öffnend, mit Oberlicht oder Festverglasung kombinierbar
 - Türflügel bis 1465 x 3000 mm (BxH), Flügelgewicht bis 230 kg
 - Füllelementstärke von 5 bis 36 mm, Glaseinbau mittels Trocken- oder Nassverglasung
 - Systemprüfungen nach Produktnorm EN 14351-1
 - Stahlprofile blank oder bandverzinkt
 - Grosses Sortiment an systemgeprüften Türbeschlägen
 - Barrierefreie Schwellenausbildungen
 - Geeignet für Pulver- und Nasslackbeschichtungen
- Système en acier pour portes et vitrages fixes
 - Profondeur de montage 60 mm, montage à fleur à l'intérieur et à l'extérieur
 - Fines largeurs de face: Cadre et vantaux à partir de 105 mm Partie tête 150 mm
 - Portes à un et deux vantaux, ouverture vers l'intérieur et vers l'extérieur, combinables avec imposte ou vitrage fixe
 - Vantaux de porte jusqu'à 1465 x 3000 mm (LaxH), poids du vantail jusqu'à 230 kg
 - Élément de remplissage de 5 à 36 mm d'épaisseur, Montage du vitrage à sec ou à silicone
 - Contrôles des systèmes selon la norme produit EN 14351-1
 - Profilés en acier brut ou galvanisé en continu
 - Grand assortiment de ferrures de porte homologuées
 - Formes de seuil sans barrière
 - Convient aux revêtements par poudre ou peinture liquide
- Steel system for doors and fixed glazing
 - 60 mm basic depth, flush-fitted on the inside and outside
 - Narrow face widths: Frame and leaf from 105 mm Meeting stile assembly 150 mm
 - Single and double-leaf doors, inward and outward-opening, can be combined with toplight or fixed glazing
 - Door leaf up to 1465 x 3000 mm (WxH), leaf weight up to 230 kg
 - Infill unit thickness of 5 to 36 mm, Glazing installed by means of dry or wet glazing
 - System tests in accordance with the product standard EN 14351-1
 - Raw finish or pre-galvanised steel profiles
 - Large range of system-tested door fittings
 - Easy-access thresholds
 - Suitable for powder and wet paint coating





Norm	Eigenschaft Caractéristique Characteristic	Klassifizierung/Wert Classification / Valeur Classification / Value										
 EN 12210	Widerstandsfähigkeit bei Windlast Résistance à la pression du vent Resistance to wind load	npd	1 (400)	2 (800)	3 (1200)	4 (1600)	5 (2000)	Exxx (>2000)				
 EN 12208	Schlagregendichtheit Étanchéité à la pluie battante Watertightness	npd	1A (0)	2A (50)	3A (100)	4A (150)	5A (200)	6A (250)	7A (300)	8A (450)	9A (600)	Exxx (>750)
 EN ISO 10140	Schalldämmung R_w (C, C_{tr}) (dB) Isolation phonique R_w (C, C_{tr}) (dB) Sound insulation R_w (C, C_{tr}) (dB)	npd	bis R_w 44 dB (-2; -5) jusqu'à R_w 44 dB (-2; -5) up to R_w 44 dB (-2; -5)									
 EN ISO 10077-2	Wärmedurchgangskoeffizient U_f (W/(m ² ·K)) Transmission thermique U_f (W/(m ² ·K)) Thermal production U_f (W/(m ² ·K))	npd	ab 5.65 W/m ² K à partir de 5.65 W/m ² K from 5.65 W/m ² K									
 EN 12207	Luftdurchlässigkeit Perméabilité à l'air Air permeability	npd	1 (150)		2 (300)		3 (600)		4 (600)			
 EN 1192	Klassifizierung der Festigkeitsanforderungen Classification des exigences de résistance méca. Classification of strength requirements	npd	1		2		3		4			
 EN 1627	Einbruchhemmung Anti-effraction Burglar resistance	npd	1		2		3		4		5	6
 EN 1522	Durchschusshemmung Résistance aux balles Bullet proofing	npd	FB1	FB2	FB3	FB4	FB5	FB6	FB7	FSG		
 EN 1191 EN 1603	Dauerfunktionsprüfung Durabilité mécanique Mechanical durability	D	1 5'000	2 10'000	3 20'000	4 50'000	5 100'000	6 200'000	7 500'000	8 1'000'000		
 EN 179 EN 1125	Fähigkeit zur Freigabe Capacité au déclenchement Ability to release		Anforderung erfüllt Exigence remplie Requirement fulfilled									

Norm	Eigenschaft Caractéristique Characteristic	Klassifizierung/Wert Classification / Valeur Classification / Value			
 EN 12217	Bedienkräfte Forces de manœuvre Operating forces	npd	0	1	2
 EN 1634-3 DIN 18095	Rauchschutz Étanchéité à la fumée Smoke control	S _a / S ₂₀₀ / RS			
 EN 16034 EN 13501-2	Selbstschliessung Fermeture automatique Self-closing	C			
 EN 16034	Dauerhaftigkeit der Selbstschliessung gegenüber Alterung (Korrosion) Endurance de la fermeture automatique contre le vieillissement (corrosion) Durability of self-closing against ageing (corrosion)	erzielt atteinte achieved			



Einbruchhemmende Jansen-Economy 60 Türen

- Türflügelgrößen 1465 x 3000 mm
- Ein- und zweiflügelige Türen, nach innen und aussen öffnend
- Geprüft nach EN 1627
- Panik- und Normalausführung

Portes anti-effraction Jansen-Economy 60

- Dimensions de vantail de porte 1465 x 3000 mm
- Portes à un/deux vantaux à ouverture vers l'intérieur et l'extérieur
- Contrôlé selon la norme EN 1627
- Exécution panique et exécution normale

Burglar-resistant Jansen Economy 60 doors

- Door leaf sizes 1465 x 3000 mm
- Single and double-leaf doors, inward and outward opening
- Tested in accordance with EN 1627
- Panic and standard design



Durchschusshemmende Jansen-Economy 60 Türen

- Türflügelgrößen 1465 x 3000 mm
- Ein- und zweiflügelige Türen, nach innen und aussen öffnend
- Geprüft nach EN 1522

Portes pare-balles Jansen-Economy 60

- Dimensions de vantail de porte 1465 x 3000 mm
- Portes à un/deux vantaux à ouverture vers l'intérieur et l'extérieur
- Contrôlé selon la norme EN 1522

Bullet-resistant Jansen Economy 60 doors

- Door leaf sizes 1465 x 3000 mm
- Single and double-leaf doors, inward and outward opening
- Tested in accordance with EN 1522



Fluchttürsysteme

- Verschlussystem für Notausgangstüren nach EN 179
- Verschlussystem für Paniktüren nach EN 1125
- Barrierefreie Türen ohne Schwelle für behindertengerechtes Bauen
- Ein- und zweiflügelige Türen nach innen und aussen öffnend
- Türflügelgrößen bis 1465 x 3000 mm und Flügelgewicht bis 230 kg

Systèmes de porte de secours

- Système de fermeture pour portes de secours selon EN 179
- Système de fermeture pour portes panique selon EN 1125
- Portes sans seuil pour faciliter l'accès aux personnes handicapées
- Portes à un/deux vantaux à ouverture vers l'intérieur et l'extérieur
- Dimensions de vantail de porte jusqu'à 1465 x 3000 mm et poids de vantail jusqu'à 230 kg

Emergency exit systems

- Closing system for emergency exit doors in accordance with EN 179
- Closing system for panic doors in accordance with EN 1125
- Barrier-free doors without threshold for accessible buildings
- Single and double-leaf doors, inward and outward opening
- Door leaf sizes up to 1465 x 3000 mm and leaf weight up to 230 kg



Jansen-Economy 60 Fingerschutzüren

- Keine Quetsch- und Scherstellen nach DIN 18650
- Wartungsarme Bandlager unten und oben
- Geeignet für Gebäude mit starkem Publikumsverkehr
- Geprüft nach EN 14351-1

Portes anti-pince-doigts Jansen-Economy 60

- Absence de zones d'écrasement et de cisaillement selon DIN 18650
- Paliers de paumelle inférieur et supérieur exigeant peu de maintenance
- Adapté à des bâtiments publics fortement fréquentés
- Contrôlé selon la norme EN 14351-1

Jansen Economy 60 anti-finger-trap doors

- No crushing and shearing points as per DIN 18650
- Low-maintenance hinge bush at top and bottom
- Suitable for buildings subject to frequent use by the public
- Tested in accordance with EN 14351-1



Verblechte Jansen-Economy 60 Türen

- Flächenbündig verblechte Türen
- Geschweisst oder geklebt
- Nach innen und aussen öffnend
- Mit Glasausschnitt möglich

Portes tôlées Jansen-Economy 60

- Portes tôlées à fleur
- Soudées ou collées
- Ouverture vers l'intérieur et l'extérieur
- Panneau de verre possible

Jansen Economy 60 sheet metal doors

- Flush-fitted sheet metal doors
- Welded or bonded
- Inward and outward-opening
- Can have glass vision panel



Jansen-Economy 60 Faltwand

- Nach innen und aussen öffnend
- Leichtgängige, geräuscharme Bedienung
- Schwellenlose Ausführung
- Flügelgewichte bis 100 kg

Porte repliable Jansen-Economy 60

- Ouverture vers l'intérieur et l'extérieur
- Mobilité silencieuse
- Exécution sans seuil
- Poids de vantail jusqu'à 100 kg

Jansen Economy 60 folding wall

- Inward and outward-opening
- Smooth and quiet operation
- Design without a threshold
- Vent weights up to 100 kg

Jansen Docu Center

Die Plattform zum effizienten Arbeiten mit Jansen Dokumentationen. Im Jansen Docu Center stehen alle Produktinformationen jederzeit digital in der aktuellsten Version zur Verfügung: von Architekten-Informationen über Bestell- und Fertigungskatalogen bis hin zu Anleitungen und Prospekten sowie Videos.

Die Inhalte können einfach und schnell aufgerufen werden. Ein für den Anwender komfortables papierloses Arbeiten, das zahlreiche Vorteile bietet.

Download CAD Daten

DXF

DWG

Sie können die Zeichnungen in den Formaten DXF und/oder DWG herunterladen. Klicken Sie auf das entsprechende Icon und der Download erfolgt.

Die Hinweise «Artikelbibliothek/Türbeschläge/Fensterbeschläge» bedeuten, dass Sie mit einem Klick die gesamte Artikelbibliothek des entsprechenden Systems herunterladen (Profile, Beschläge, Glasleisten, Zubehör etc.).

Info und Beratung

Gerne beraten wir Sie persönlich und stehen Ihnen bei Fragen zur Verfügung. Bitte schreiben Sie uns Ihre Anliegen an: info@jansen.com

Jansen Docu Center

La plate-forme pour travailler efficacement avec les documentations Jansen. Le Jansen Docu Center met à votre disposition les informations sur les produits, en format numérique et dans une version actualisée: des catalogues de commande et de fabrication aux instructions et prospectus, en passant par les informations destinées aux architectes et vidéos.

Les contenus sont facilement et rapidement accessibles. Une manière de travailler confortable et offrant de nombreux avantages.

Télécharger fichiers DAO

DXF

DWG

Vous pouvez télécharger les dessins aux formats DXF et/ou DWG. Cliquez sur l'icône correspondante et le téléchargement s'effectuera.

Les indications «Bibliothèque des articles/Ferures de porte/Ferrures de fenêtres» signifie que vous téléchargez la totalité de la bibliothèque des articles du système donné (profilés, ferrures, parclofes, accessoires etc.).

Info et conseils

Nous vous conseillerons volontiers individuellement et sommes à votre disposition si vous avez des questions à poser. Veuillez nous envoyer votre requête à: info@jansen.com

Jansen Docu Center

The platform for working efficiently with Jansen documentation. The latest version of all the product information is available digitally at any time in the Jansen Docu Center – from order and fabrication manuals to architect information, instructions and brochures and videos.

The content can be retrieved quickly and easily. The user can work conveniently without paper, which has numerous benefits.

Download CAD files

DXF

DWG

You can download the drawings in DXF and/or DWG format. Click on the relevant icon to begin the download.

The items «Article library/Door fittings/Window fittings» means that you download the entire article library for the corresponding system with one click (profiles, fittings, glazing beads, accessories etc.).

Information and advice

We would be delighted to provide you with advice in person and are available to answer any questions you may have. Please write to us with your queries at: info@jansen.com

Zulassungen/Prüfungen
Homologations/Essais
Authorisations/Tests

Jansen-Economy 60 Türen
Jansen-Economy 60 portes
Jansen-Economy 60 doors

Elementgrößen
(Empfehlung für CE-Kennzeichnung)

Dimensions des éléments
(Recommandation pour le label CE)

Size of elements
(Recommendation for CE marking)

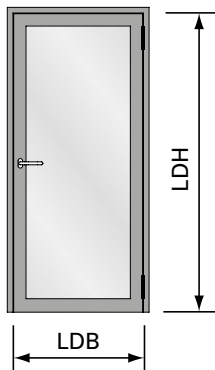

LDB Lichte Durchgangsbreite
max. 1400 mm
min. 490 mm

LDB Largeur vide lumière
max. 1400 mm
min. 490 mm

LDB Clear opening width
max. 1400 mm
min. 490 mm

LDH Lichte Durchgangshöhe
max. 3000 mm
min. 1900 mm

LDH Hauteur vide lumière
max. 3000 mm
min. 1900 mm

LDH Clear opening height
max. 3000 mm
min. 1900 mm

Flügelgewicht max. 230 kg

Poids de vantail max. 230 kg

Weight of leaf max. 230 kg

Zulassungen/Prüfungen
Homologations/Essais
Authorisations/Tests

Jansen-Economy 60 Türen
Jansen-Economy 60 portes
Jansen-Economy 60 doors

Elementgrößen
(Empfehlung für CE-Kennzeichnung)

Dimensions des éléments
(Recommandation pour le label CE)

Size of elements
(Recommendation for CE marking)

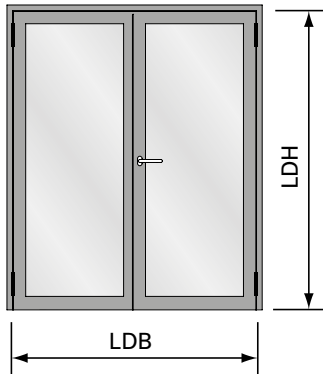

LDB Lichte Durchgangsbreite
max. 2800 mm
min. 1000 mm

LDB Largeur vide lumière
max. 2800 mm
min. 1200 mm

LDB Clear opening width
max. 2800 mm
min. 1000 mm

LDH Lichte Durchgangshöhe
max. 3000 mm
min. 1900 mm

LDH Hauteur vide lumière
max. 3000 mm
min. 1900 mm

LDH Clear opening height
max. 3000 mm
min. 1900 mm

Flügelgewicht max. 230 kg

Poids de vantail max. 230 kg

Weight of leaf max. 230 kg

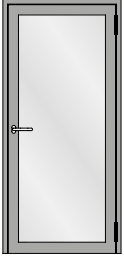

Einflügelige Türe
Porte à un vantail
Single leaf door

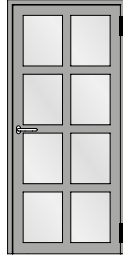

Einflügelige Türe mit Riegel
Porte à un vantail avec traverse
Single leaf door with transom

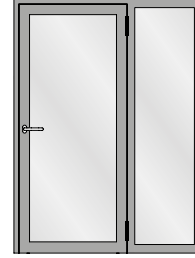

Einflügelige Türe mit Seitenteil
Porte à un vantail avec partie latérale
Single leaf door with side light

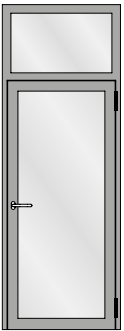

Einflügelige Türe mit Oberlicht
Porte à un vantail avec imposte
Single leaf door with top light

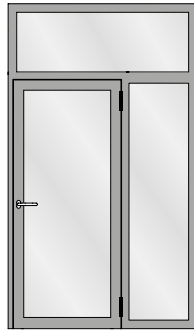

Einflügelige Türe mit Seitenteil und Oberlicht
Porte à un vantail avec avec partie latérale
et imposte
Single leaf door with side light and top light

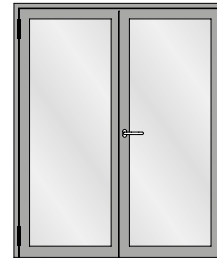

Zweiflügelige Türe
Porte à deux vantaux
Double leaf door



Zweiflügelige Türe mit zwei Seitenteilen
Porte à deux vantaux avec deux parties latérales
Double leaf door with two side lights

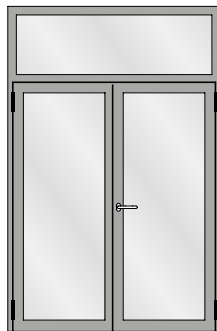

Zweiflügelige Türe mit Oberlicht
Porte à deux vantaux avec imposte
Double leaf door with top light

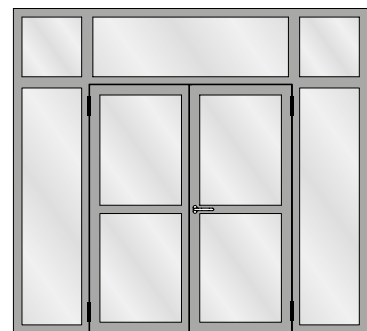

Zweiflügelige Türe mit zwei Seitenteilen und Oberlichtern
Porte à deux vantaux avec deux parties latérales et impostes
Double leaf door with two side lights and top lights

Typenübersicht
Sommaire des types
Summary of types

Jansen-Economy 60 Türen
Jansen-Economy 60 portes
Jansen-Economy 60 doors

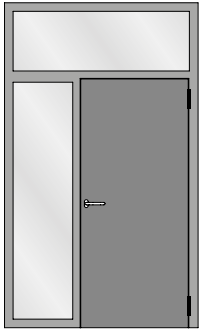

Verblechte Türe mit Seitenteil und Oberlicht
Porte tôlée à un vantail avec avec partie latérale
et imposte
Sheet metal single leaf door with side light
and top light



Verblechte zweiflügelige Türe mit zwei
Seitenteilen und Oberlichtern
Porte tôlée à deux vantaux avec deux parties
latérales et impostes
Sheet metal double leaf door with two side
lights and top lights



Festverglasung
Vitrage fixe
Fixed glazing

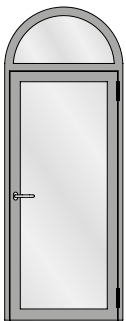

Einflügelige Türe mit Rundbogen-Oberlicht
Porte à un vantail avec imposte demi-ronde
Single leaf door with round arched top light

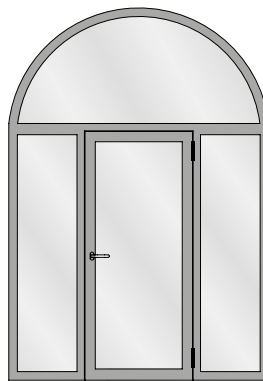

Einflügelige Türe mit zwei Seitenteilen und
Rundbogen-Oberlicht
Porte à un vantail avec deux parties latérales
et imposte demi-ronde
Single leaf door with two side lights and
round arched top light

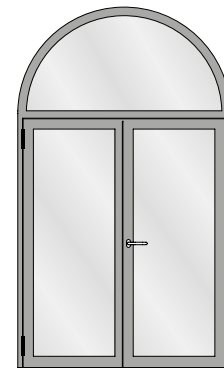

Zweiflügelige Türe mit Rundbogen-Oberlicht
Porte à deux vantaux avec imposte demi-ronde
Double leaf door with round arched top light

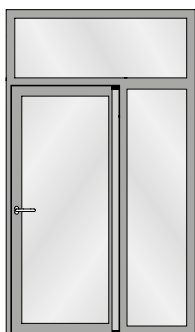

Fingerschutztüre
Porte anti-pince-doigts
Anti-finger-trap door

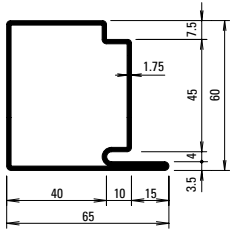

30.019
30.019 Z

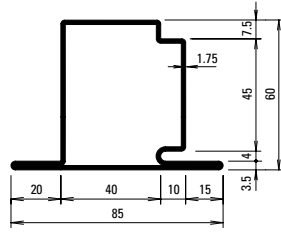

30.119
30.119 Z

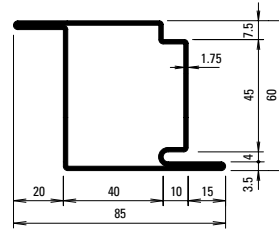

30.419
30.419 Z

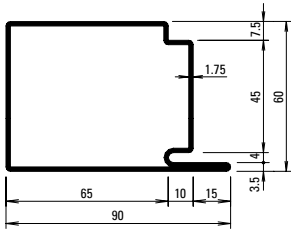

30.017
30.017 Z

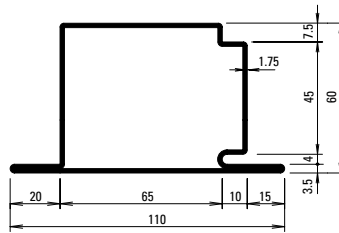

30.117
30.117 Z

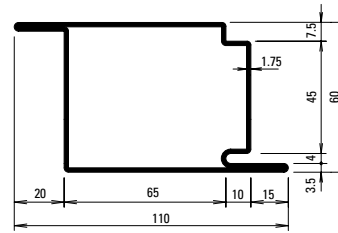

30.415

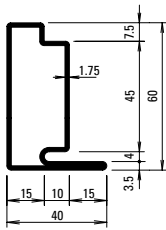

30.018
30.018 Z

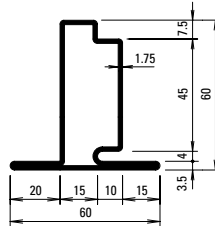

30.118
30.118 Z

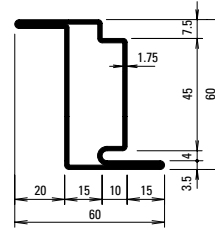

30.418
30.418 Z

Oberfläche/Werkstoff

Artikel-Nr.

ohne Zusatz = blank

mit Z = bandverzinkter Stahl

Surface/Matériau

No. d'article

sans supplément = brut

avec Z = bande d'acier zinguée

Surface/Material

Part no.

without addition = bright

with Z = strip galvanised steel

Profil-Nr.	G kg/m	F cm ²	I _x cm ⁴	W _x cm ³	I _y cm ⁴	W _y cm ³	U m ² /m
30.017	4,200	5,36	31,32	9,09	48,57	10,35	0,312
30.018	2,830	3,61	15,95	4,35	4,77	1,93	0,212
30.019	3,520	4,48	23,69	6,70	19,75	5,55	0,262
30.117	4,750	6,04	34,75	9,35	65,74	11,51	0,350
30.118	3,370	4,29	18,64	4,65	8,26	2,75	0,250
30.119	4,050	5,16	26,80	6,99	29,12	6,58	0,300

Profil-Nr.	G kg/m	F cm ²	I _x cm ⁴	W _x cm ³	I _y cm ⁴	W _y cm ³	U m ² /m
30.415	4,750	6,04	37,79	12,28	65,74	11,51	0,350
30.418	3,370	4,29	22,92	7,37	8,62	2,75	0,250
30.419	4,050	5,16	30,36	9,82	29,12	6,58	0,300

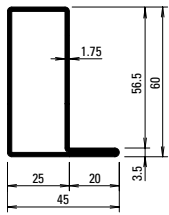

01.634
01.634 Z

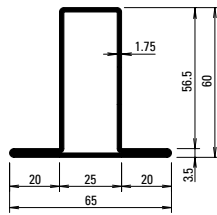

02.634
02.634 Z

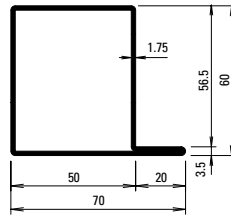

01.684
01.684 Z

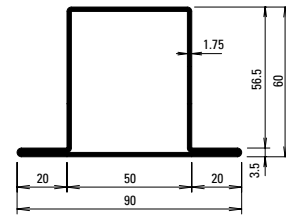

02.684
02.684 Z

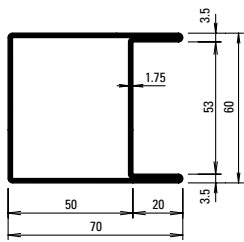

04.637
04.637 Z

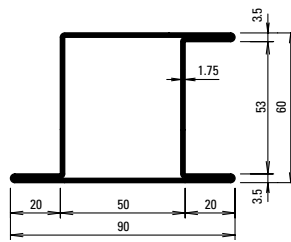

05.637
05.637 Z

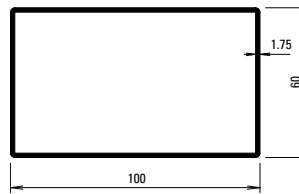

400.051
400.051 Z

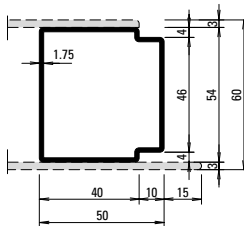

81.010 Z

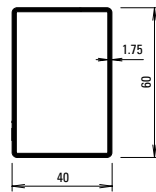

400.052
400.052 Z

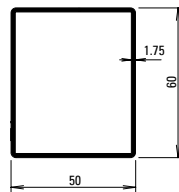

400.054
400.054 Z

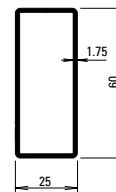

400.055
400.055 Z

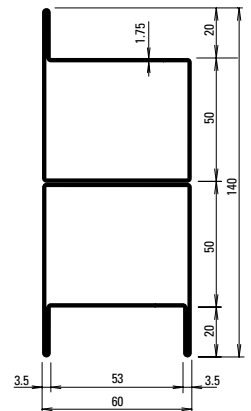

05.001

Profil-Nr.	G kg/m	F cm ²	I _x cm ⁴	W _x cm ³	I _y cm ⁴	W _y cm ³	U m ² /m
01.634	2,730	3,48	16,71	4,71	6,04	2,15	0,204
02.634	3,270	4,17	19,66	5,01	10,34	3,18	0,243
01.684	3,430	4,37	24,34	7,07	22,12	5,59	0,255
02.684	3,960	5,05	27,70	7,36	31,93	7,09	0,294
04.637	3,960	5,05	30,62	10,2	27,45	7,71	0,294
05.637	4,500	5,72	35,42	10,6	39,45	8,02	0,333
81.010	2,700	3,43	14,53	5,38	13,05	5,10	0,202
400.051	4,300	5,44	76,01	15,2	34,64	11,55	0,316
400.052	2,630	3,34	8,98	4,49	16,86	5,62	0,197
400.054	2,900	3,69	14,97	5,98	19,83	6,61	0,217
400.055	2,210	2,82	3,08	2,47	12,41	4,13	0,167

Stabachse
Axe de la barre
Bar axis

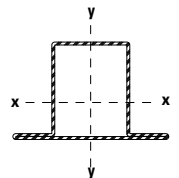

Artikelbibliothek
 Bibliothèque des articles
 Article library

DXF **DWG**

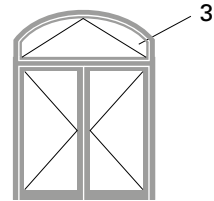
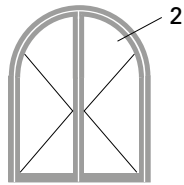
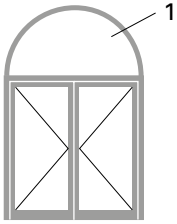

1.0

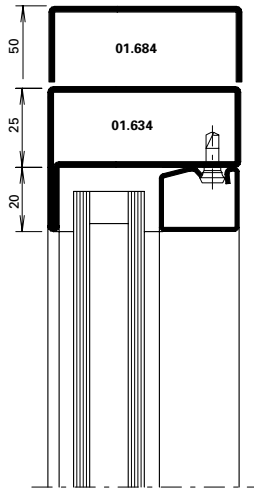

2.0

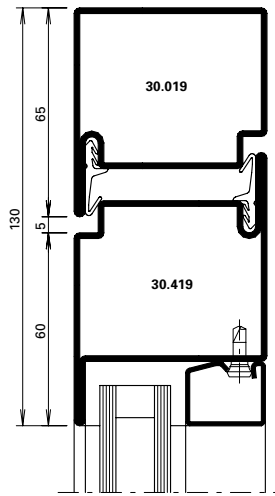

3.0

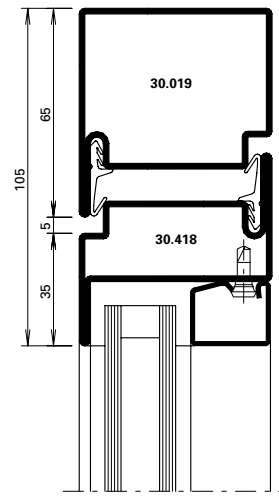

Halbrundbogen
 Arc semi-circulaire
 Semi-circular arch

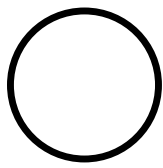

Rundbogen
 Arc en plein centre
 Round arch

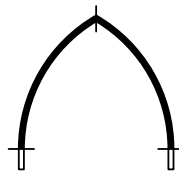

Spitzbogen
 Ogive
 Gothic arch



Stichbogen
 Arc bombé
 Segmented arch



Korbbogen
 Anse de panier
 Oval arch

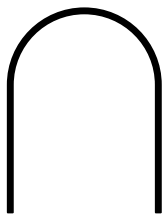

Halbrundbogen mit Schenkel
 Arc surhaussé
 Semi-circular arch with side extension

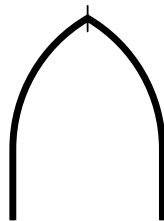

Spitzbogen mit Schenkel
 Arc en ogive
 Gothic arch with side extension

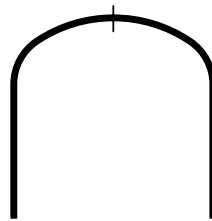



Korbbogen mit Schenkel
 Anse de panier prolongée
 Oval arch with side extension

Bogentüren
Portes cintrées
Arched doors

Jansen-Economy 60 Türen
Jansen-Economy 60 portes
Jansen-Economy 60 doors

Profil Profilé Profile	Min. Radius Rayon min. Min. radius R	
------------------------------	---	--

	blank brut bright	verzinkt zinguée galvanised
	mm	mm
01.634	550	550
01.684	650	650

	blank brut bright	verzinkt zinguée galvanised
	mm	mm
02.634	600	650
02.684	1050	1050

	blank brut bright	verzinkt zinguée galvanised
	mm	mm
04.637	1550	1550

	blank brut bright	verzinkt zinguée galvanised
	mm	mm
05.637	1550	1550

	blank brut bright	verzinkt zinguée galvanised
	mm	mm
400.052	1100	1100
400.054	1000	1000
400.055	800	800
81.010		800

Profil Profilé Profile	Min. Radius Rayon min. Min. radius R	
------------------------------	---	--

	blank brut bright	verzinkt zinguée galvanised
	mm	mm
30.018		550
30.019	650	650

	blank brut bright	verzinkt zinguée galvanised
	mm	mm
30.118	800	800
30.119	900	900

	blank brut bright	verzinkt zinguée galvanised
	mm	mm
30.418	800	800
30.419	1100	1100

Stahl-Glasleisten Parcloses en acier Steel glazing beads	Min. Radius Rayon min. Min. radius R
--	---

	mm
62.507 Z	300 mm
62.508 Z	300 mm
62.509 Z	300 mm

Stahl-Glasleisten Parcloses en acier Steel glazing beads	Min. Radius Rayon min. Min. radius R
--	---

	mm
402.112 Z	500 mm
402.115 Z	500 mm
402.120 Z	600 mm
402.125 Z	750 mm
402.130 Z	1000 mm
402.135 Z	1500 mm

Aluminium-Glasleisten Parcloses en aluminium Aluminium glazing beads	Min. Radius Rayon min. Min. radius R
--	---

	mm
404.109	400 mm
404.112	400 mm
404.115	400 mm
404.120	400 mm
404.125	450 mm
404.130	500 mm
404.135	600 mm

	mm
405.110	500 mm
405.115	500 mm
405.120	500 mm
405.125	800 mm
405.130	1000 mm
406.903	500 mm
406.905	500 mm
406.907	500 mm
406.909	600 mm

Die Radien-Angaben beziehen sich auf die langjährige Erfahrung und Fertigung im Hause Jansen.

Les rayons indiqués se fondent sur la longue expérience et la fabrication au sein de la maison Jansen.

The radii specifications are based on the many years of experience Jansen has in fabrication.

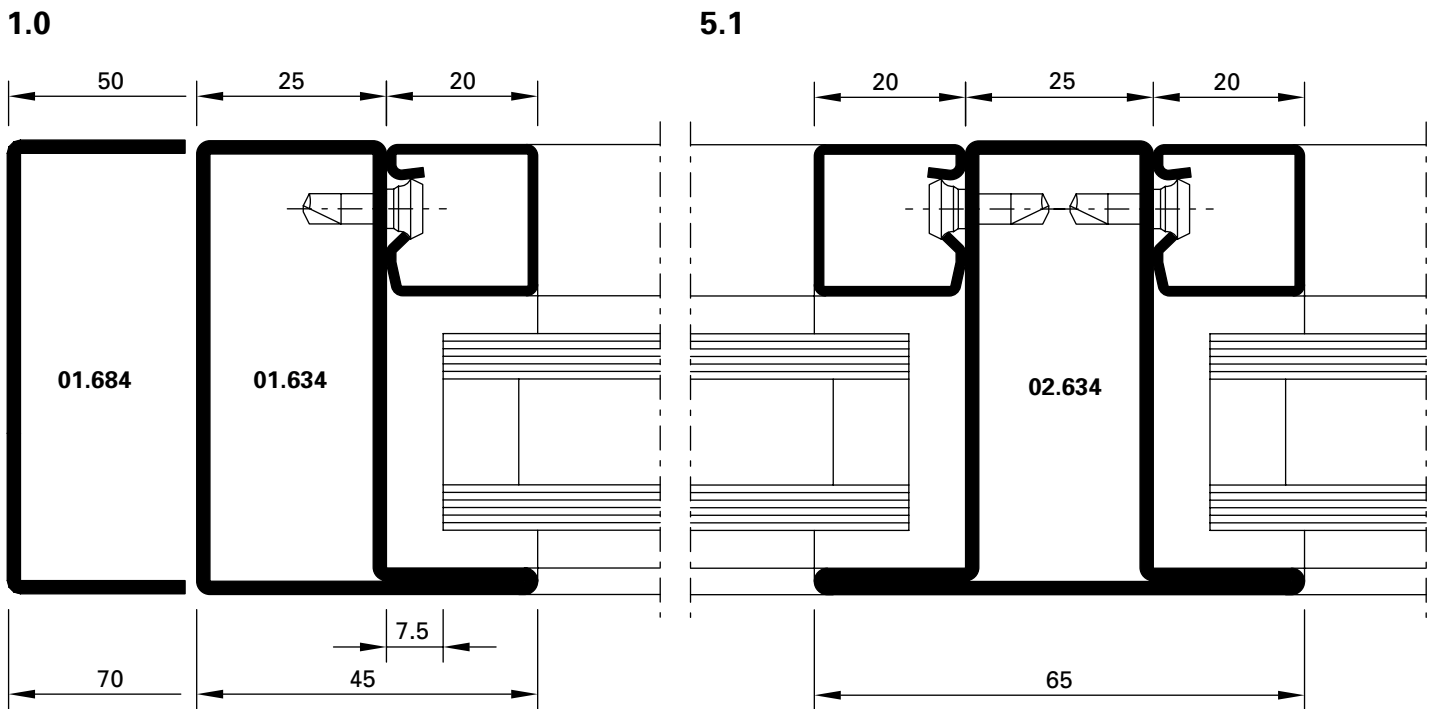
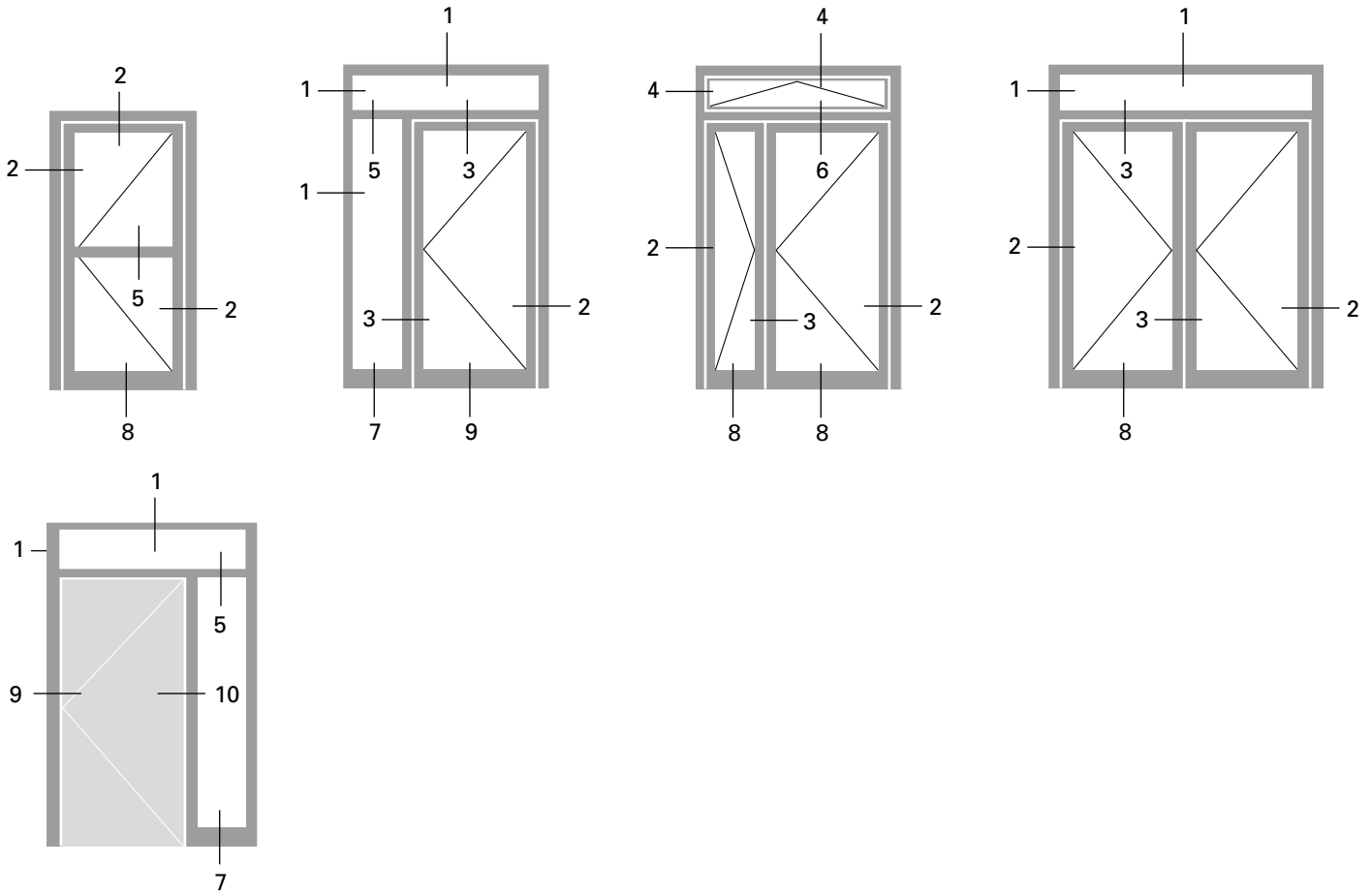

DXF DWG D-250-C-001

DXF DWG D-250-C-032

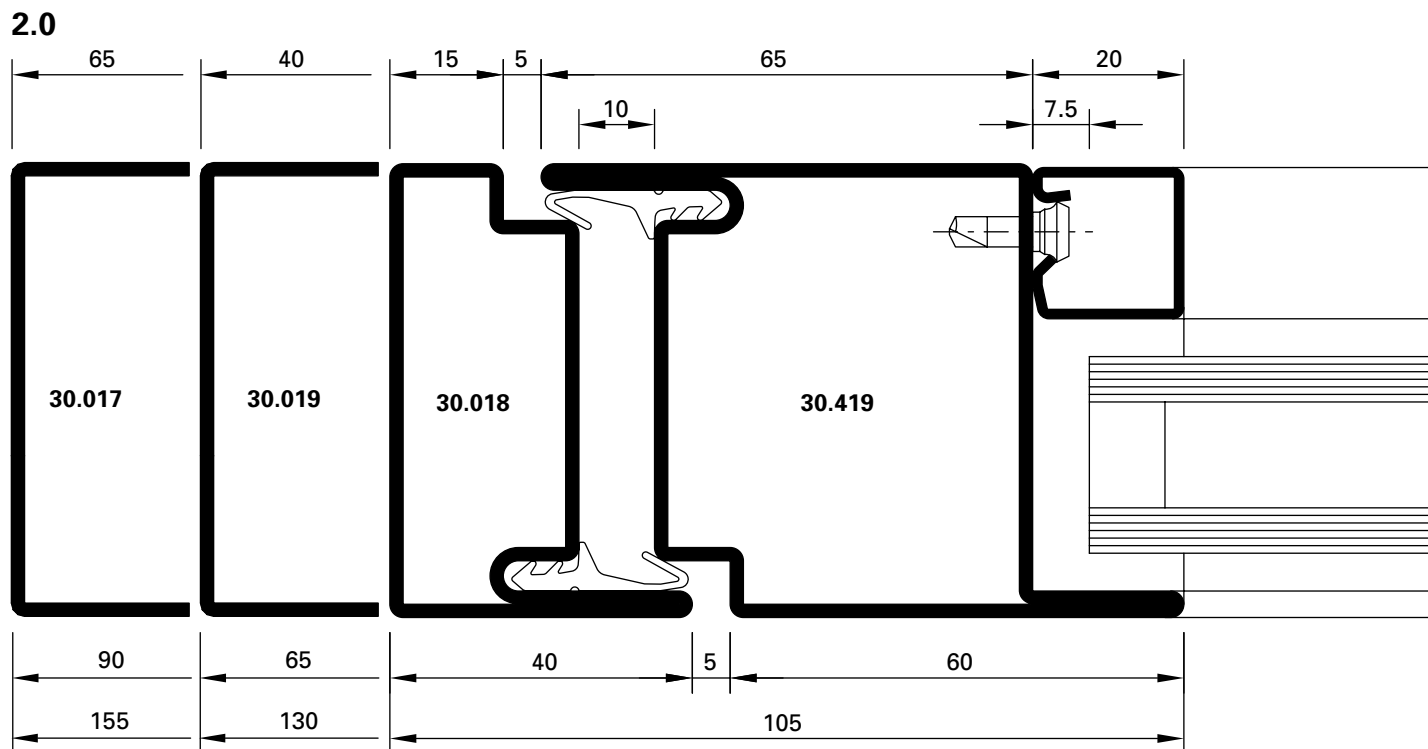

DXF DWG D-250-C-002

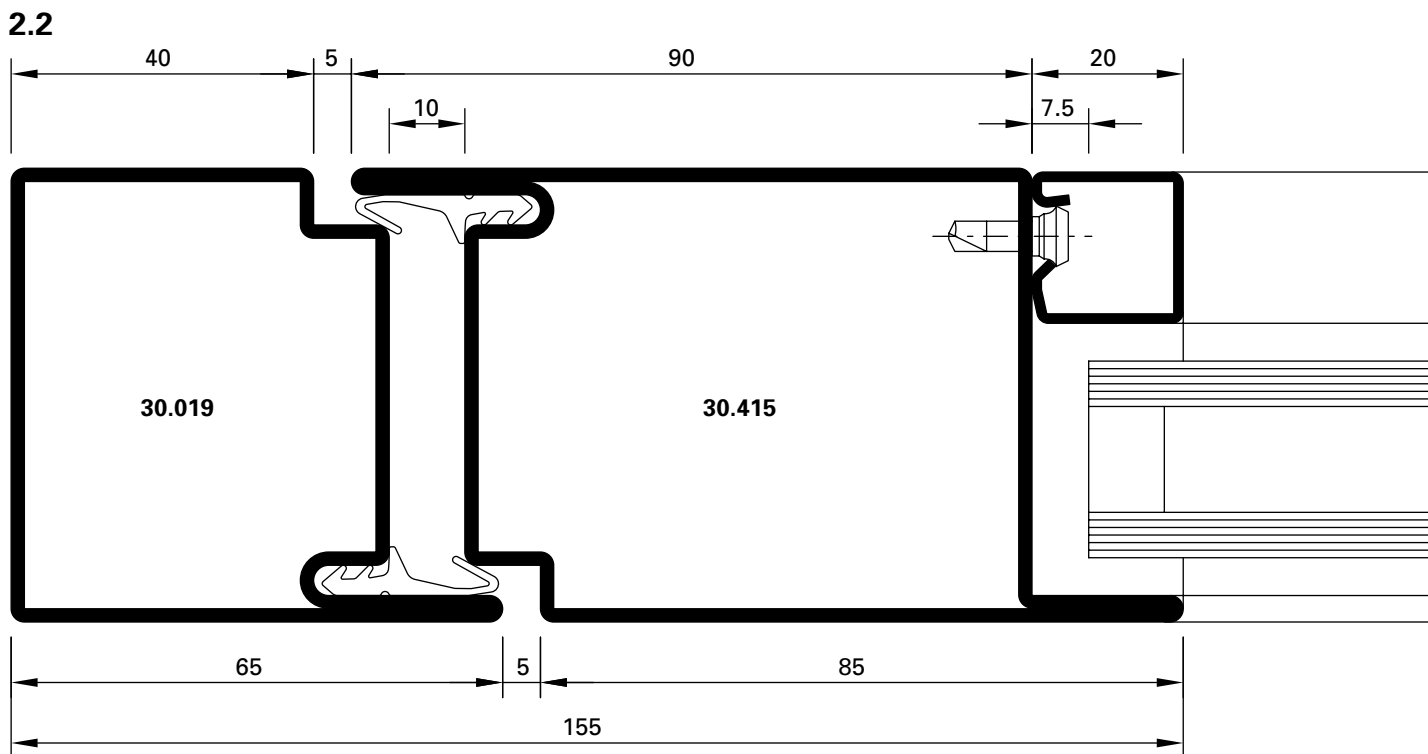

DXF DWG D-250-C-005

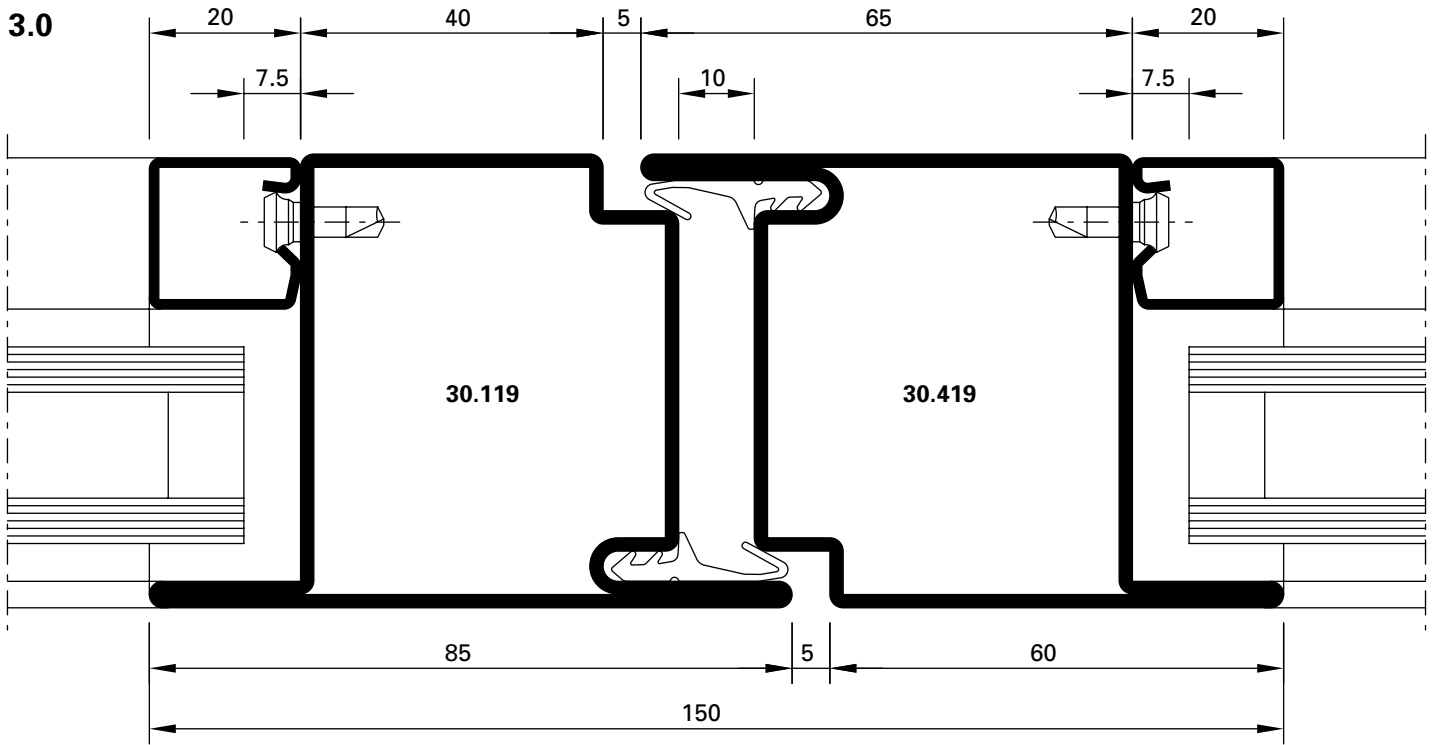

DXF DWG D-250-C-003

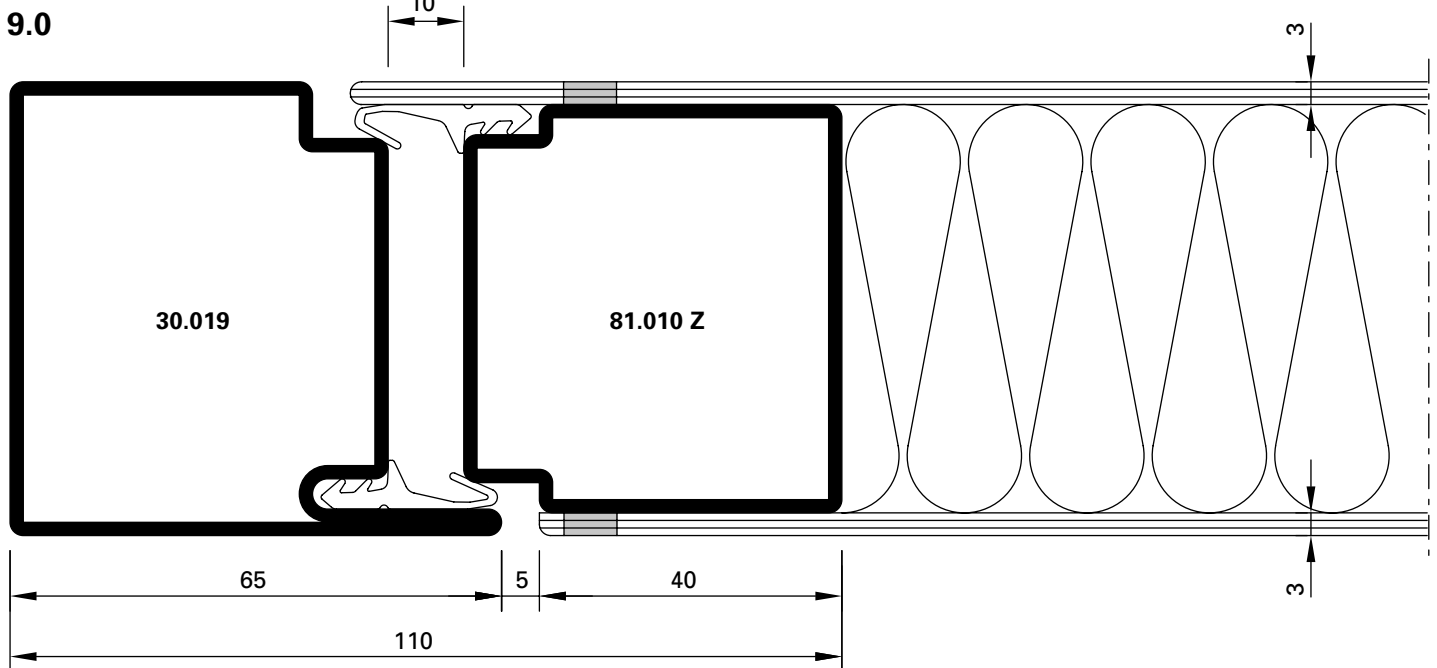

DXF DWG D-250-C-013

4.0

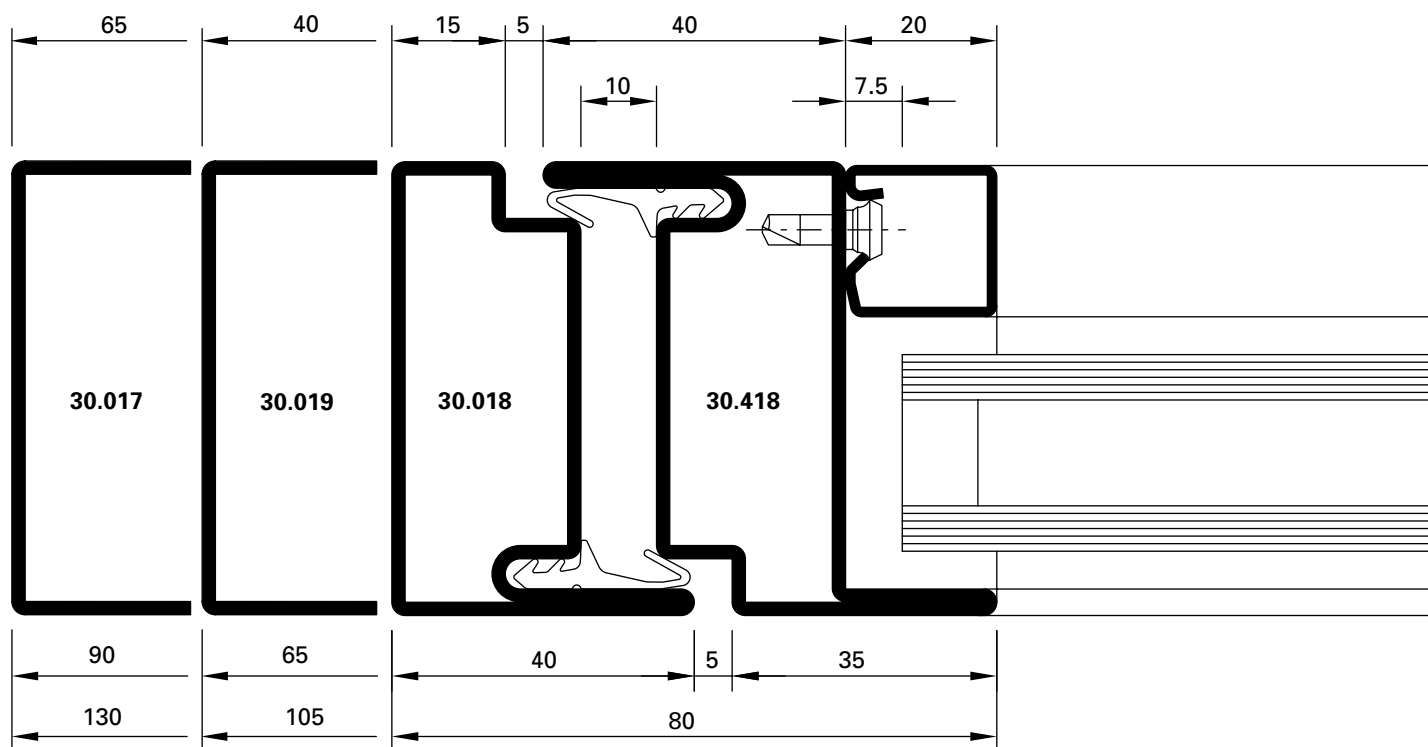

DXF **DWG** D-250-C-010

5.0

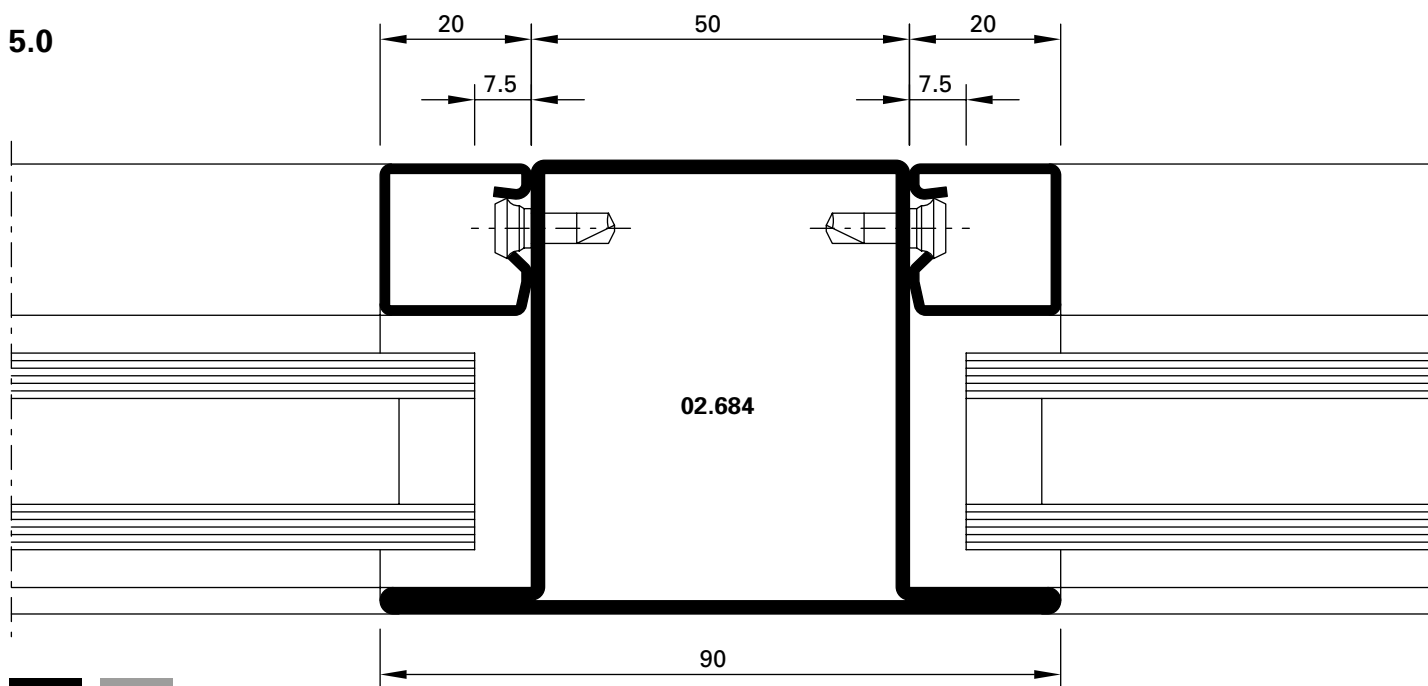

DXF **DWG** D-250-C-012

8.0

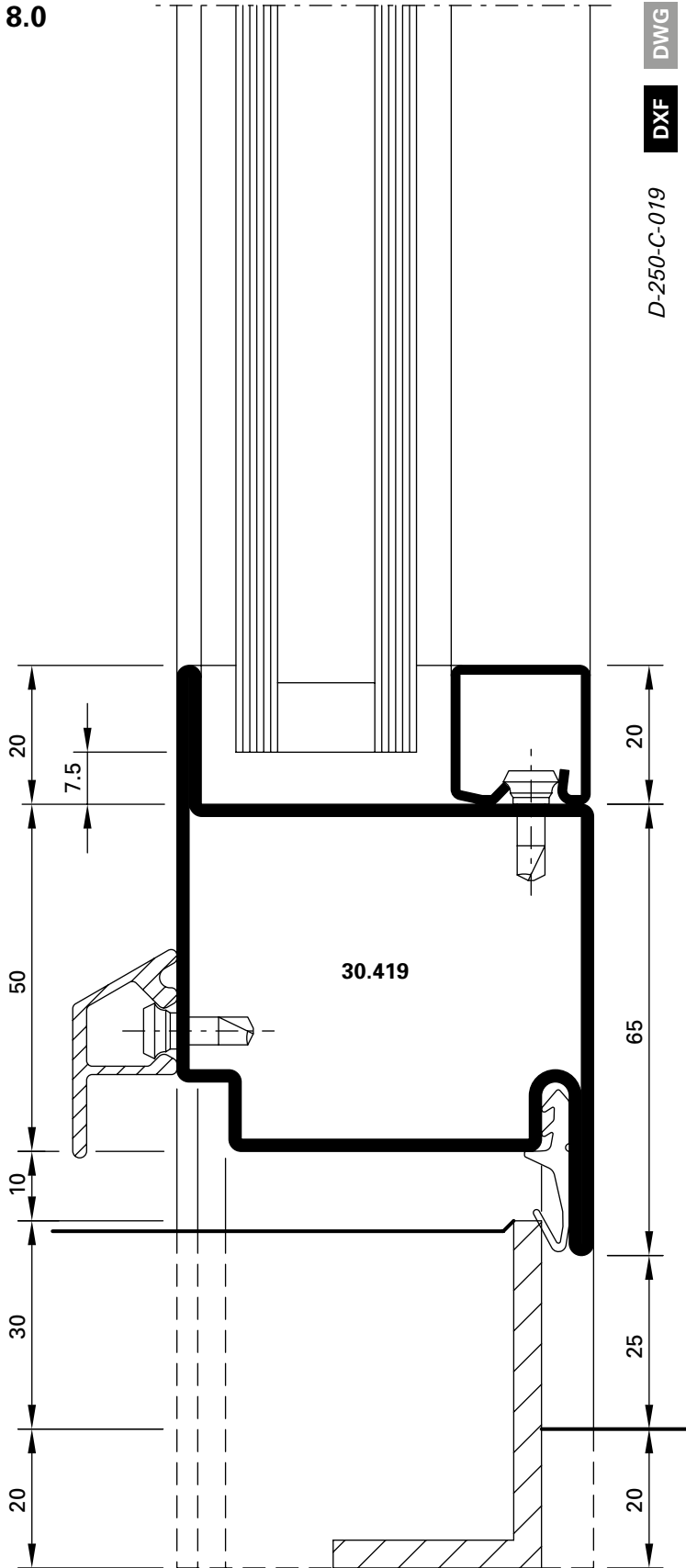

8.1

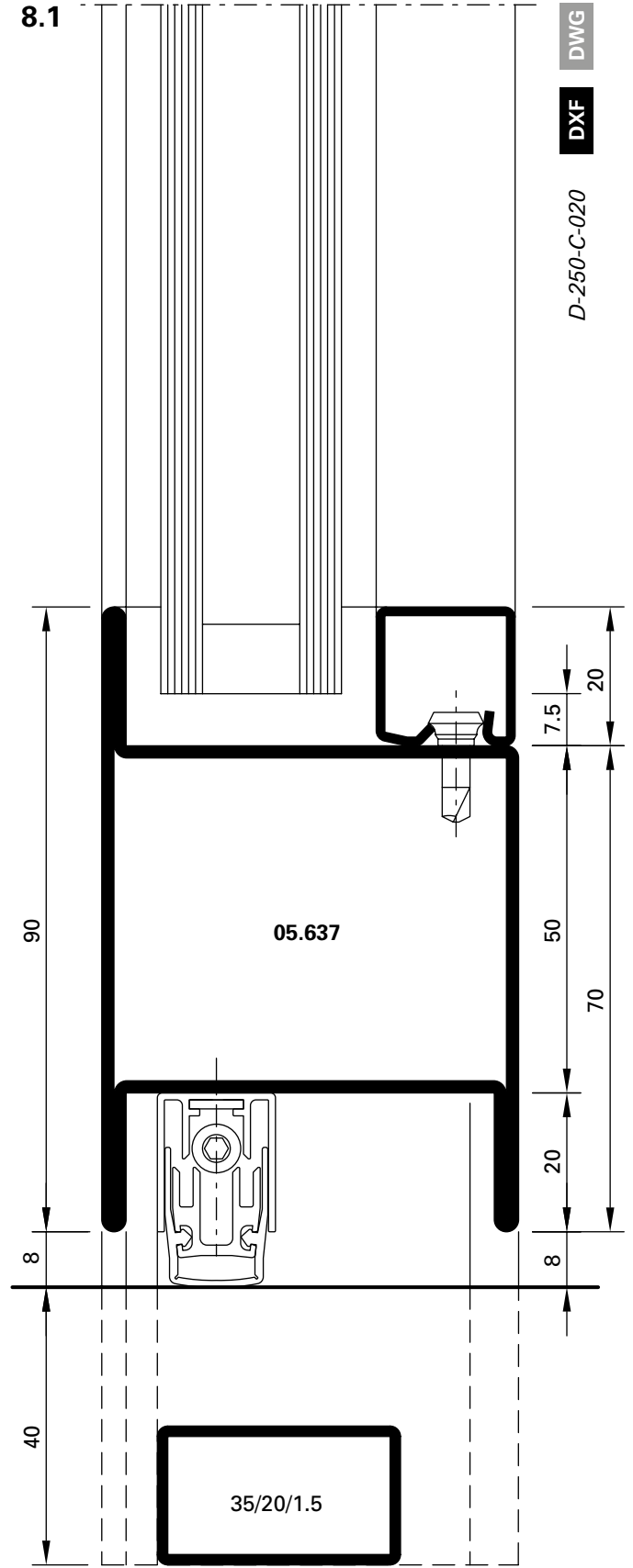

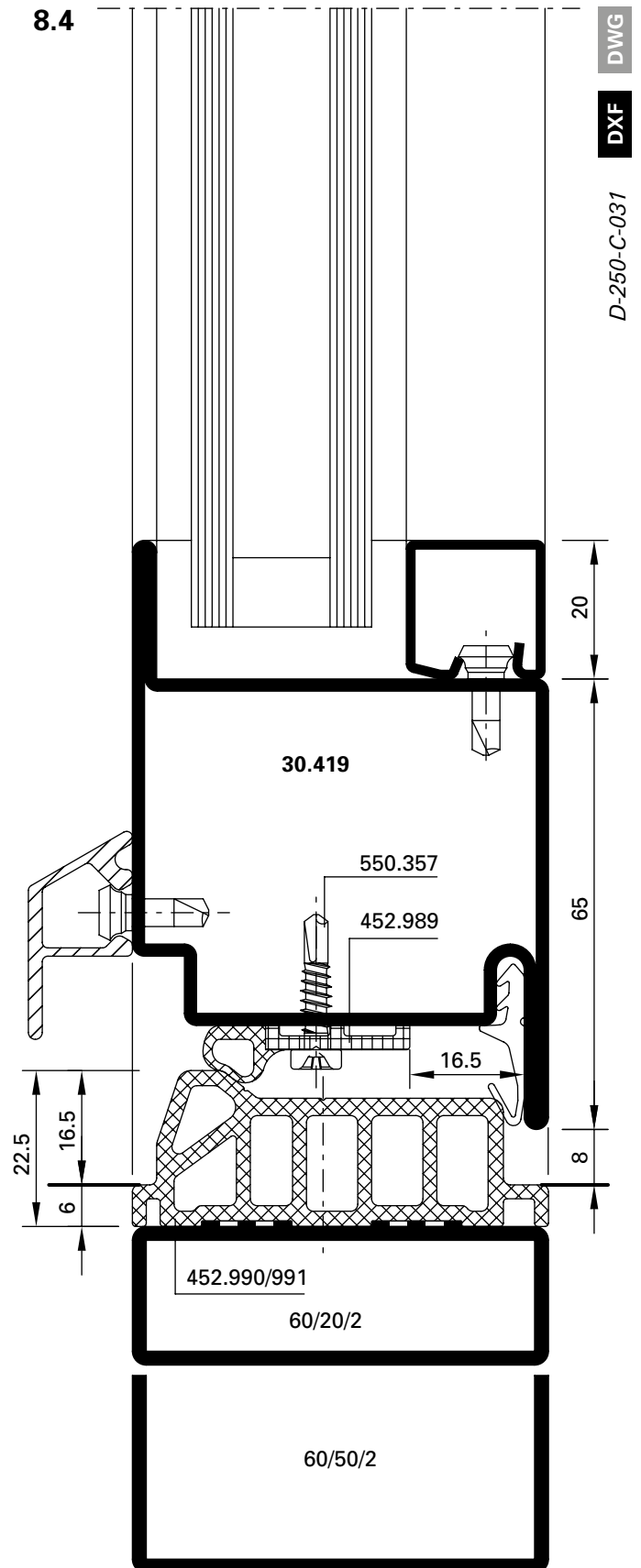
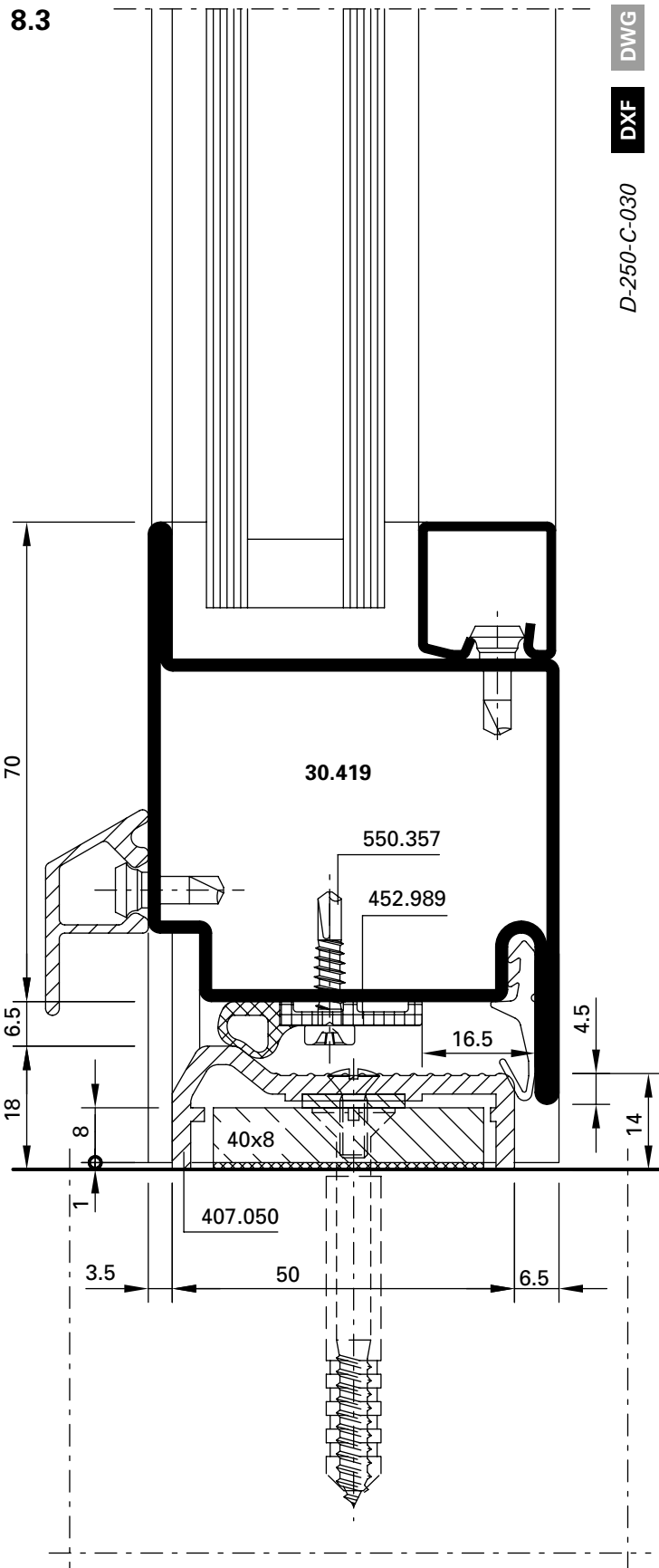

2.1

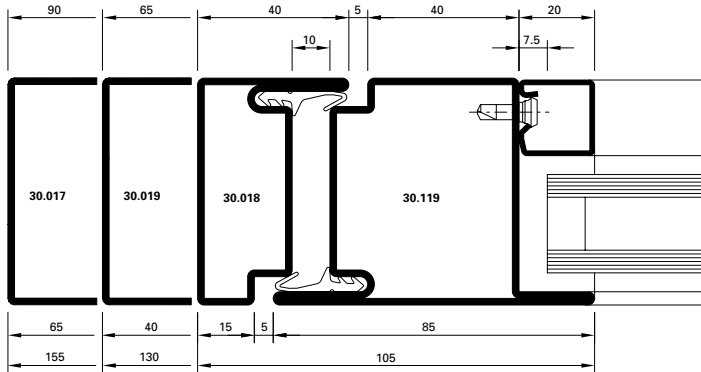

DXF **DWG** *D-250-C-004*

2.3

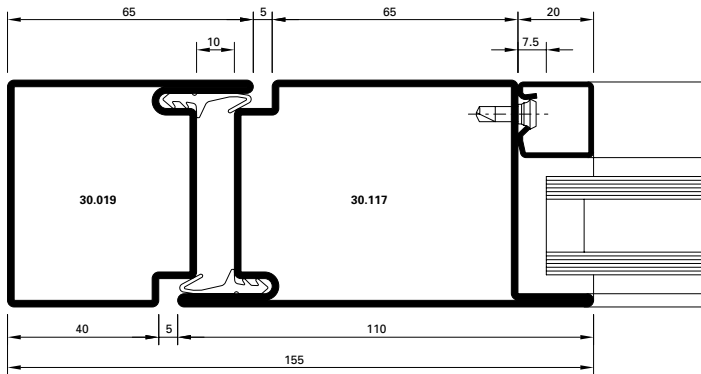

DXF **DWG** *D-250-C-006*

3.1

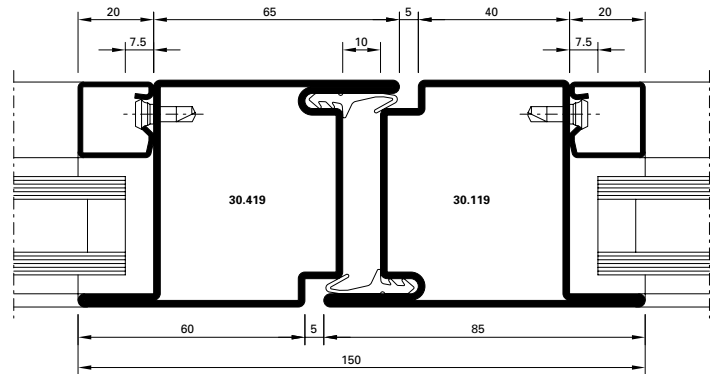

DXF **DWG** *D-250-C-007*

3.2

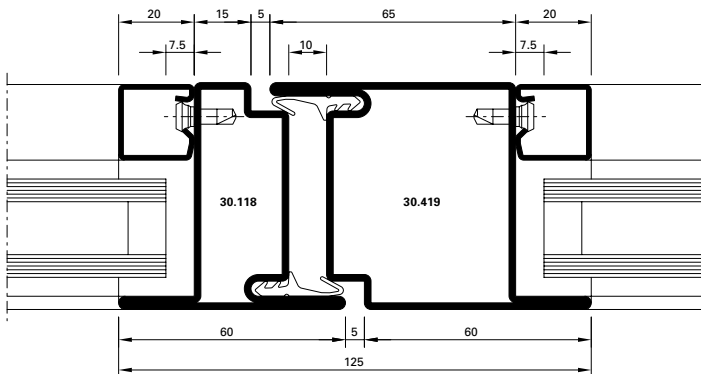

DXF **DWG** *D-250-C-008*

3.3

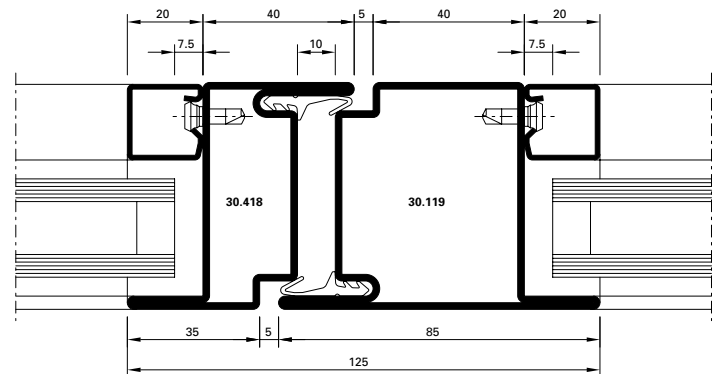

DXF **DWG** *D-250-C-009*

9.1

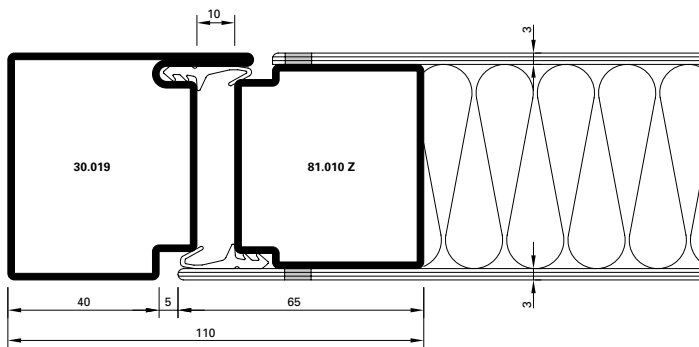

DXF **DWG** D-250-C-014

10.0

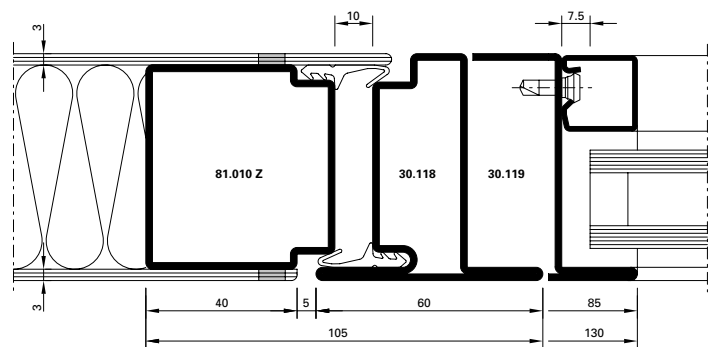

DXF **DWG** D-250-C-015

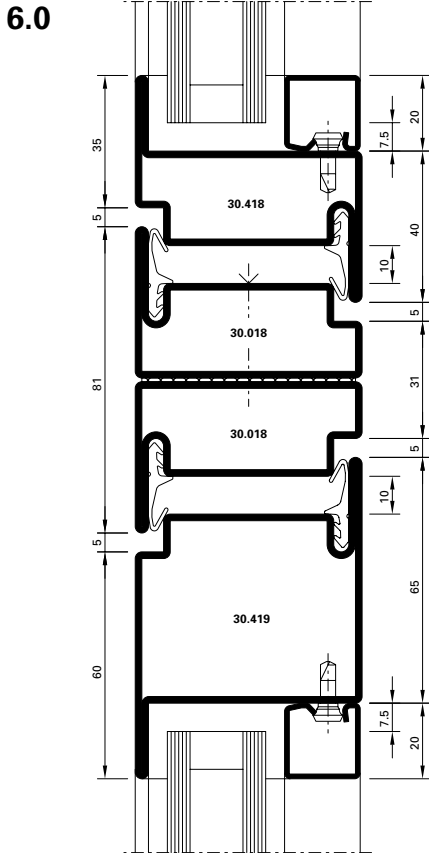

DWG
 DXF
 D-250-C-016

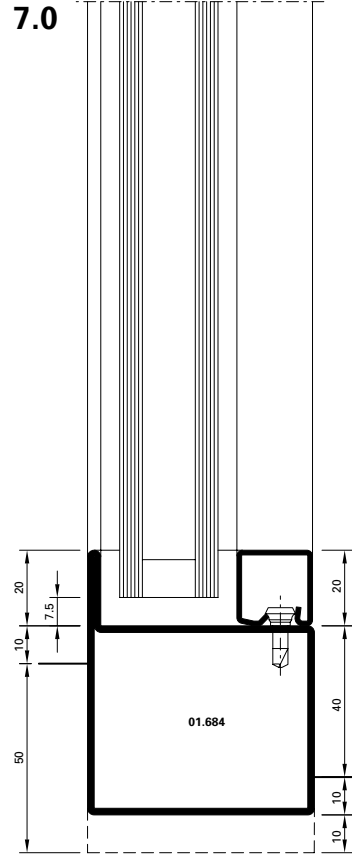

DWG
 DXF
 D-250-C-017

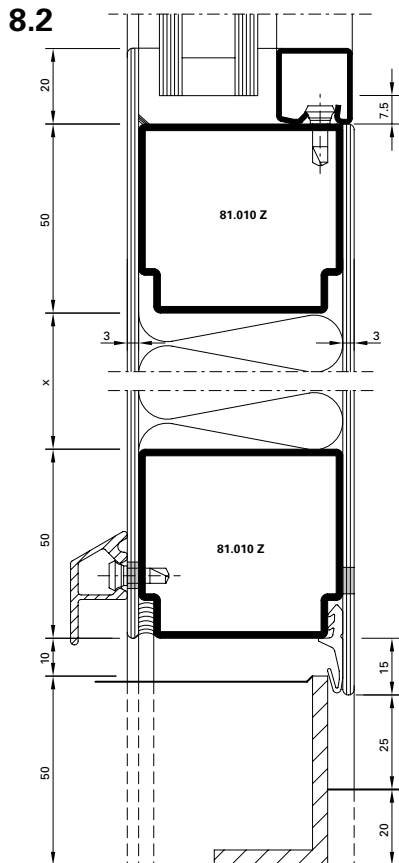

DWG
 DXF
 D-250-C-021

5.1

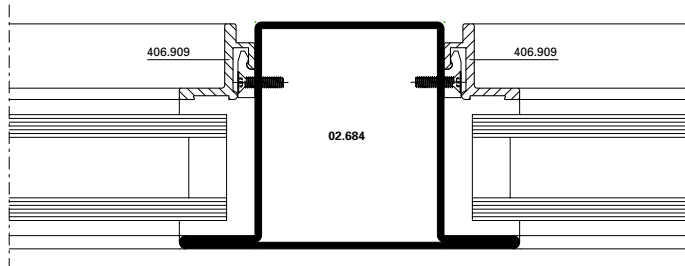

DXF **DWG** *D-250-C-022*

5.2

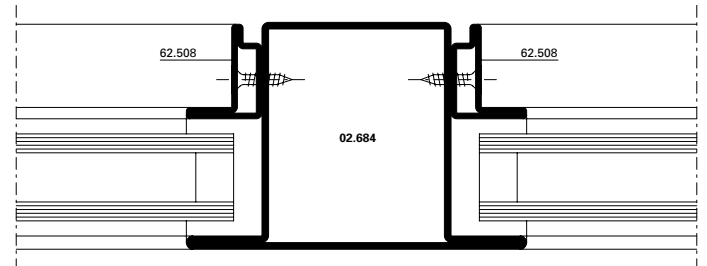

DXF **DWG** *D-250-C-023*

5.3

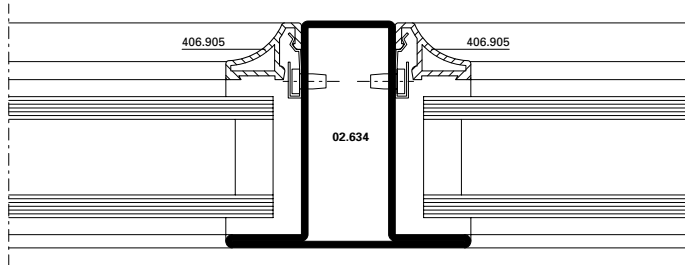

DXF **DWG** *D-250-C-024*

5.4

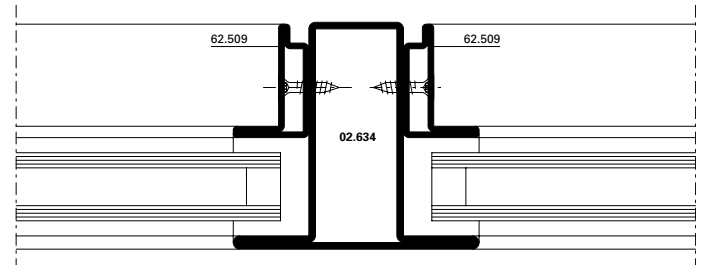

DXF **DWG** *D-250-C-025*

5.5

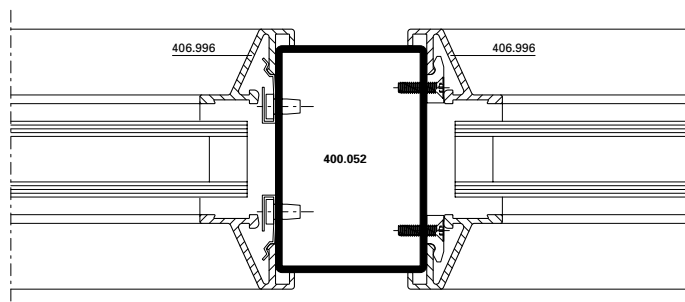

DXF **DWG** *D-250-C-026*

5.6

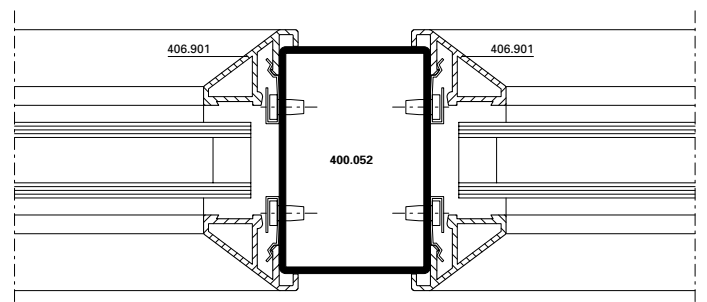

DXF **DWG** *D-250-C-027*

5.7

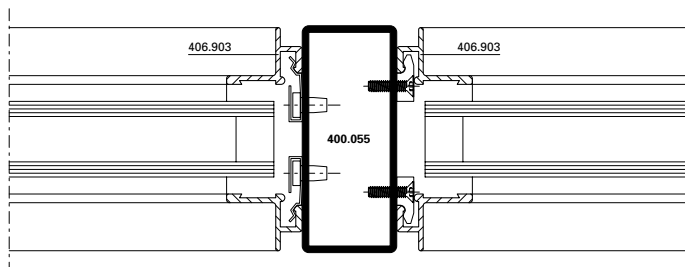

DXF **DWG** *D-250-C-028*

5.8

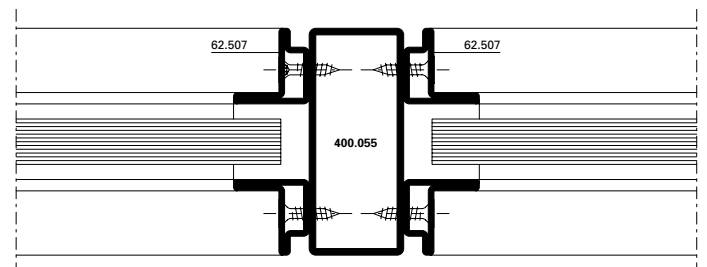

DXF **DWG** *D-250-C-029*

Schnittpunkte im Massstab 1:1
Coupe de détails à l'échelle 1:1
Section details on scale 1:1

Jansen-Economy 60 Türen
Jansen-Economy 60 portes
Jansen-Economy 60 doors

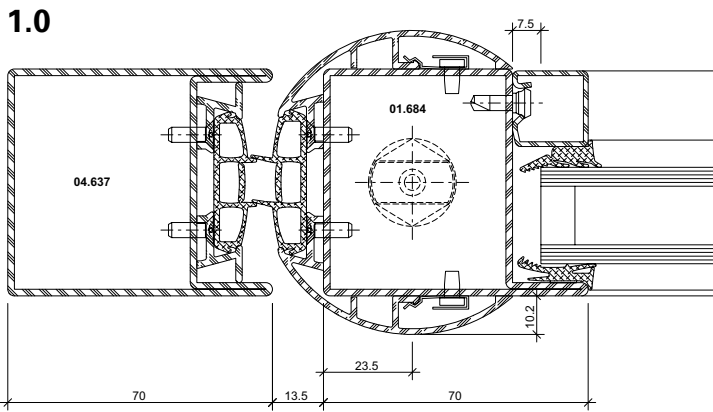
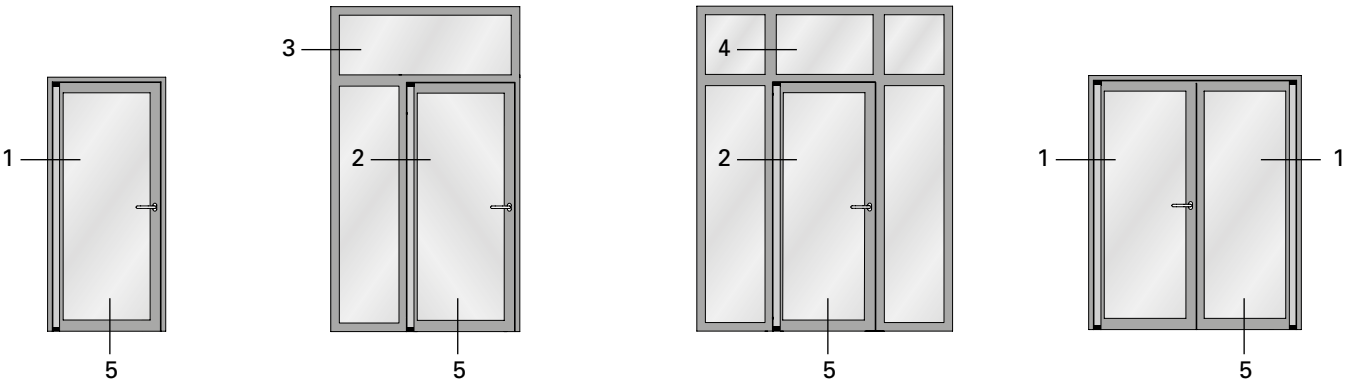

DXF **DWG** 22-0103-C-001

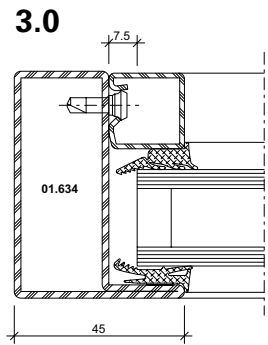

22-0101-C-001

DXF **DWG**

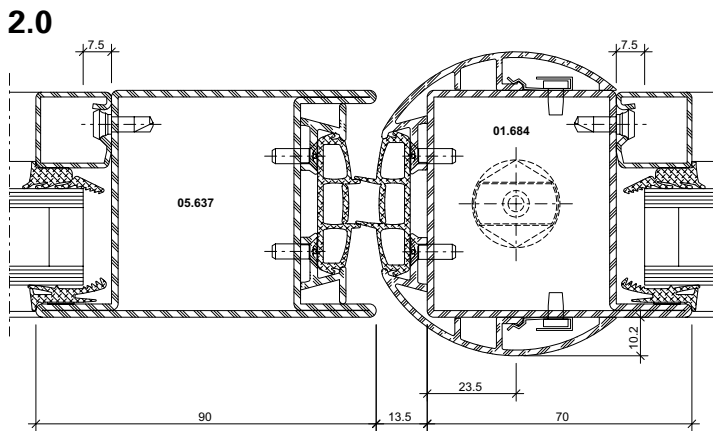

DXF **DWG** 22-0103-C-002

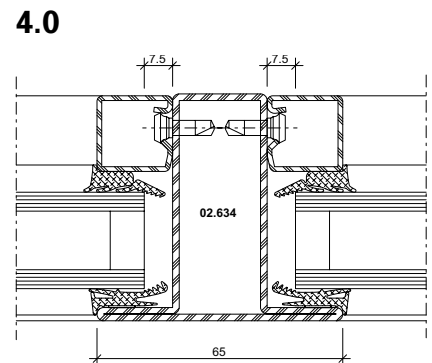

22-0101-C-002

DXF **DWG**

5.0

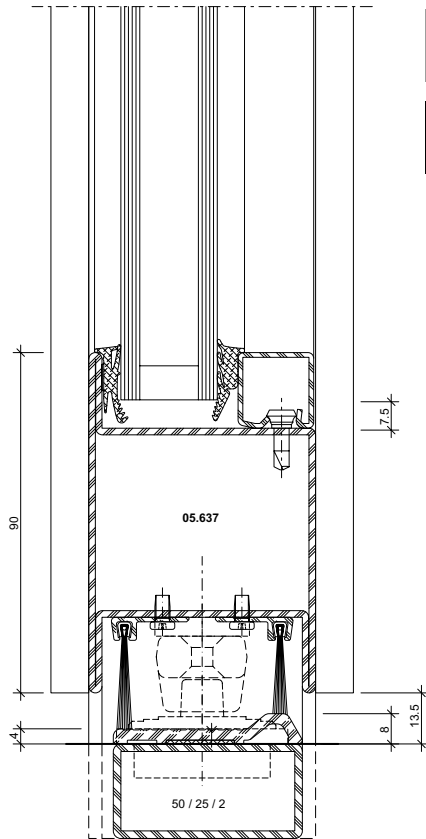

DWG

DXF

22-0103-C-003

5.1

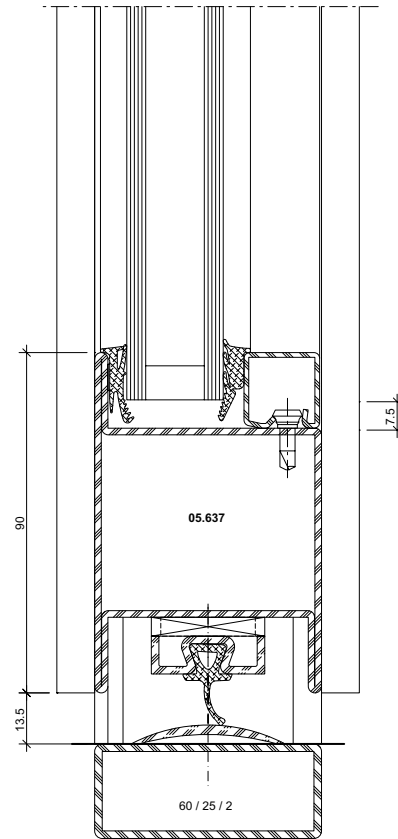

DWG

DXF

22-0103-C-009

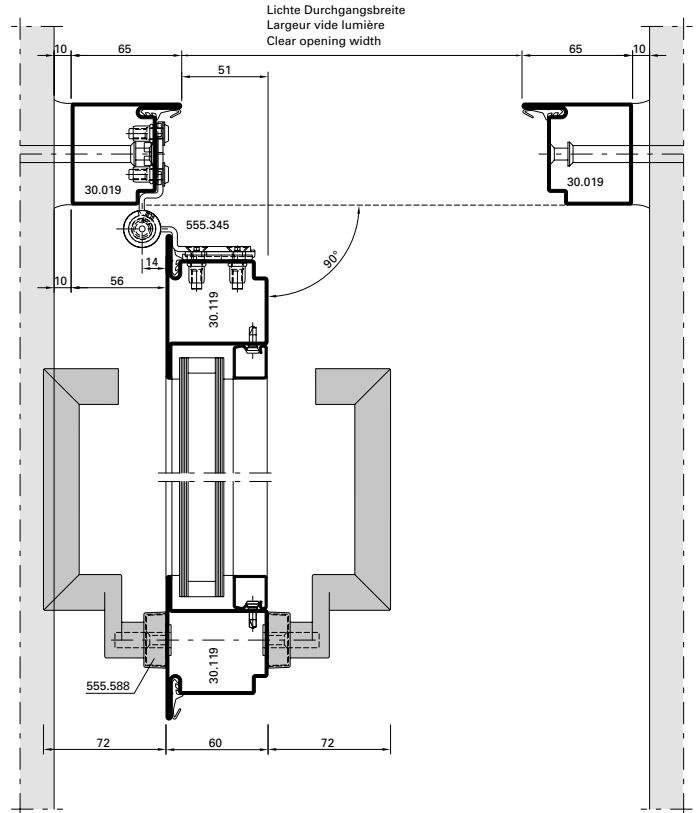
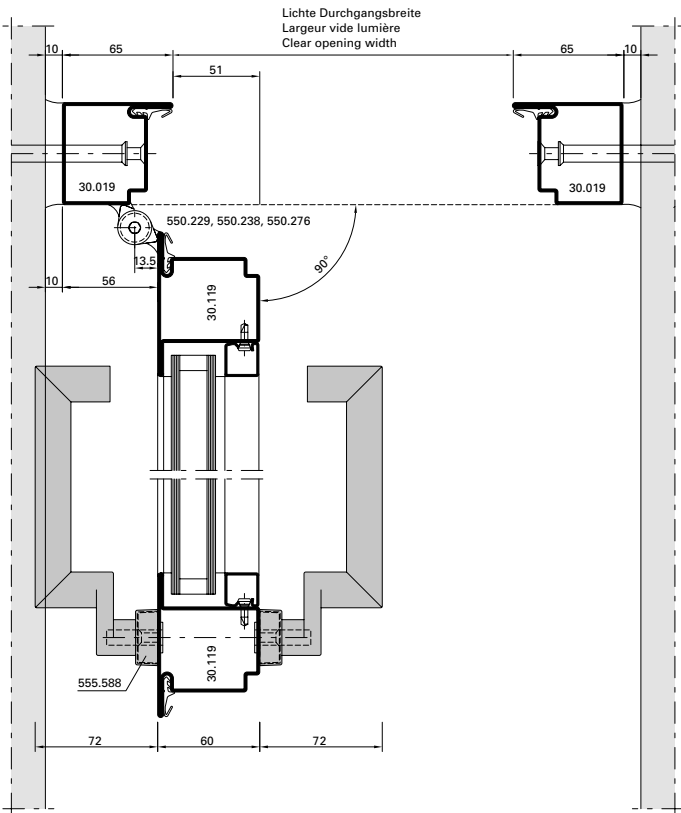

DXF **DWG** *D-250-E-016*

DXF **DWG** *D-250-E-018*

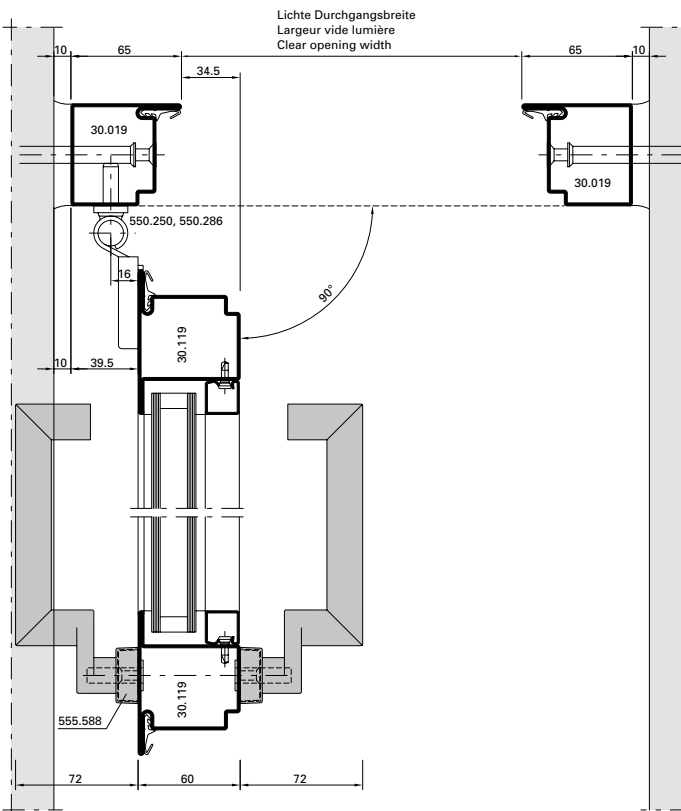

DXF **DWG** *D-250-E-020*

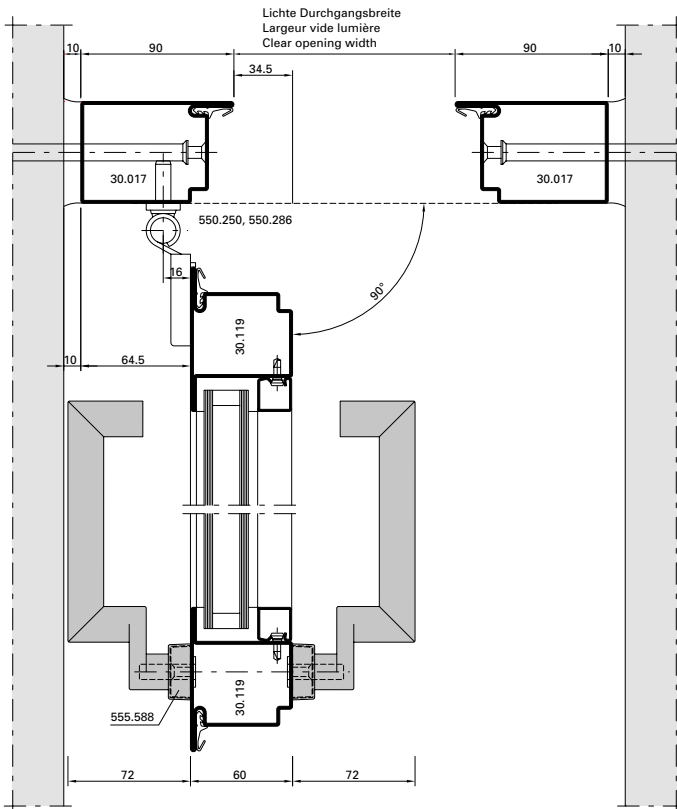

DXF **DWG** *D-250-E-021*

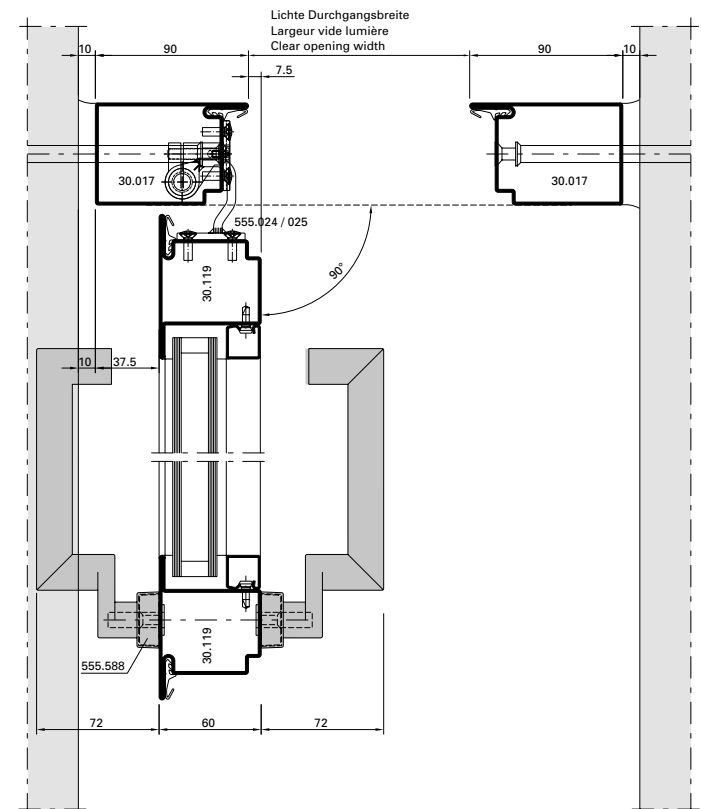

DXF **DWG** *D-250-E-025*

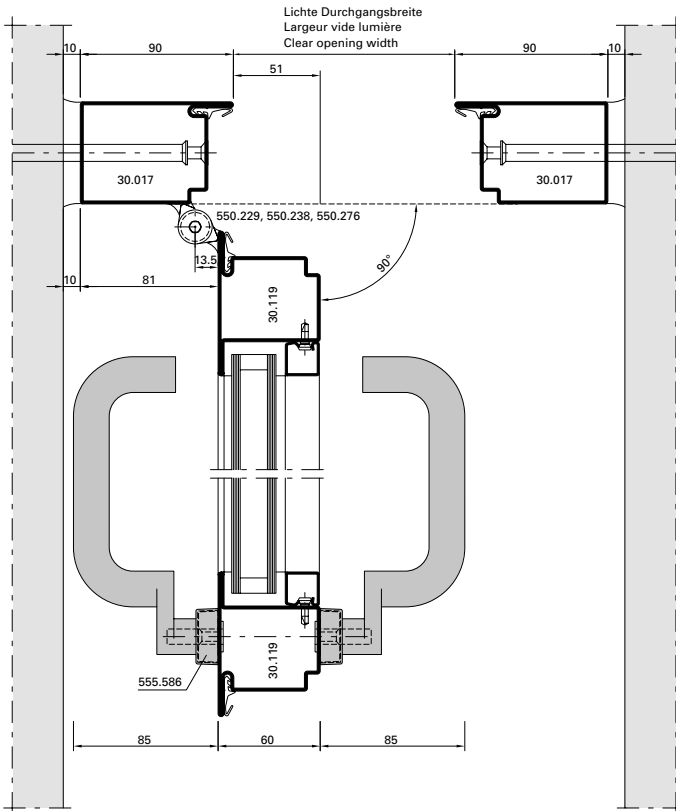

DXF **DWG** *D-250-E-017*

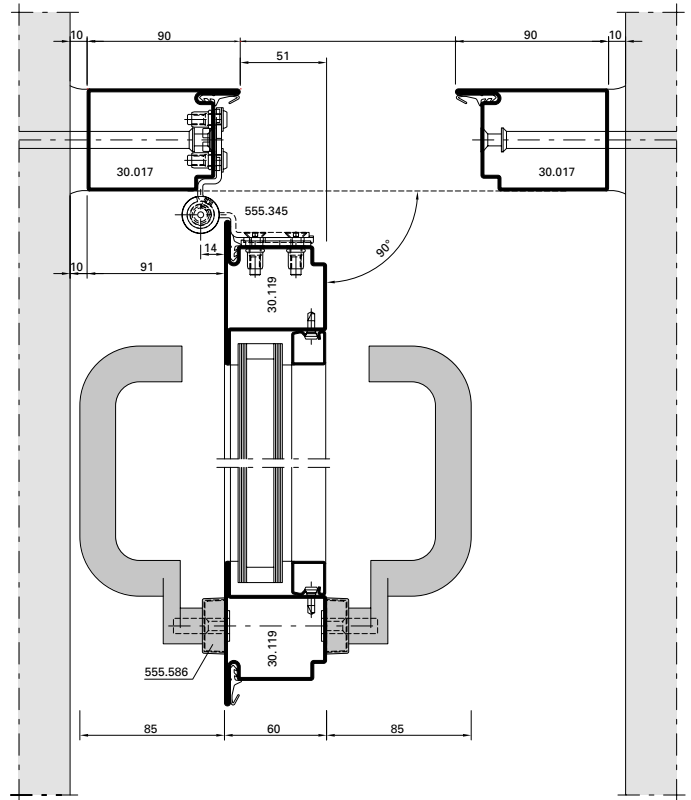

DXF **DWG** *D-250-E-019*

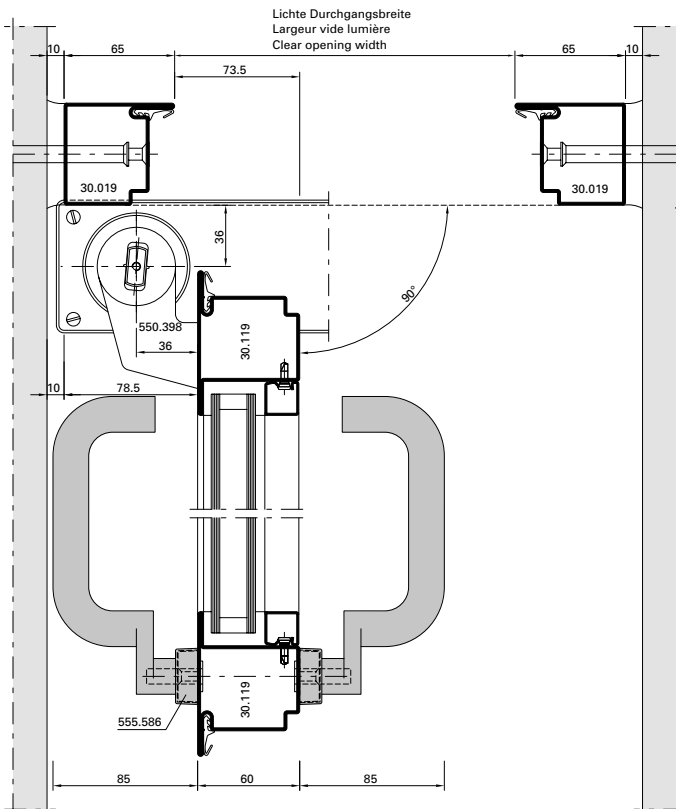

DXF **DWG** *D-250-E-022*

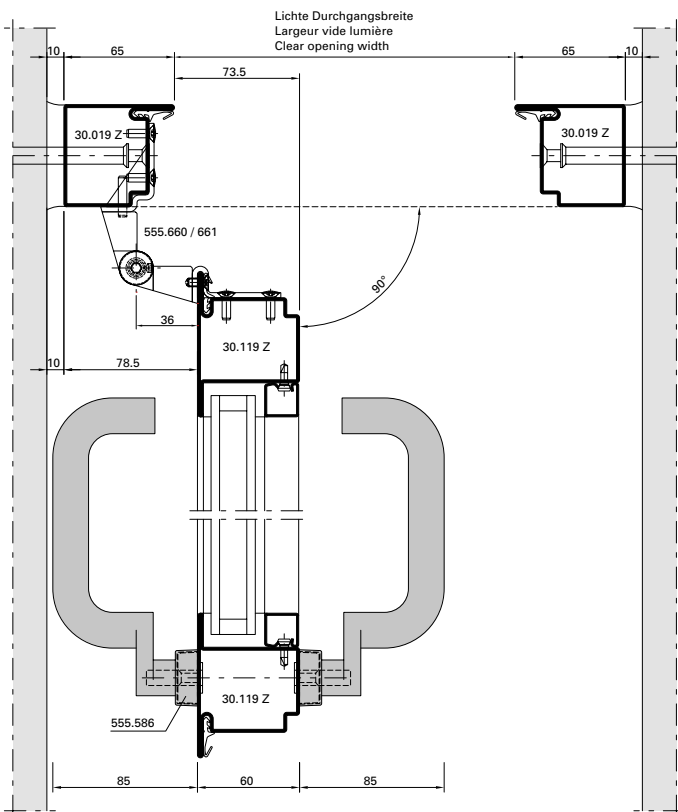

DXF **DWG** *D-250-E-023*

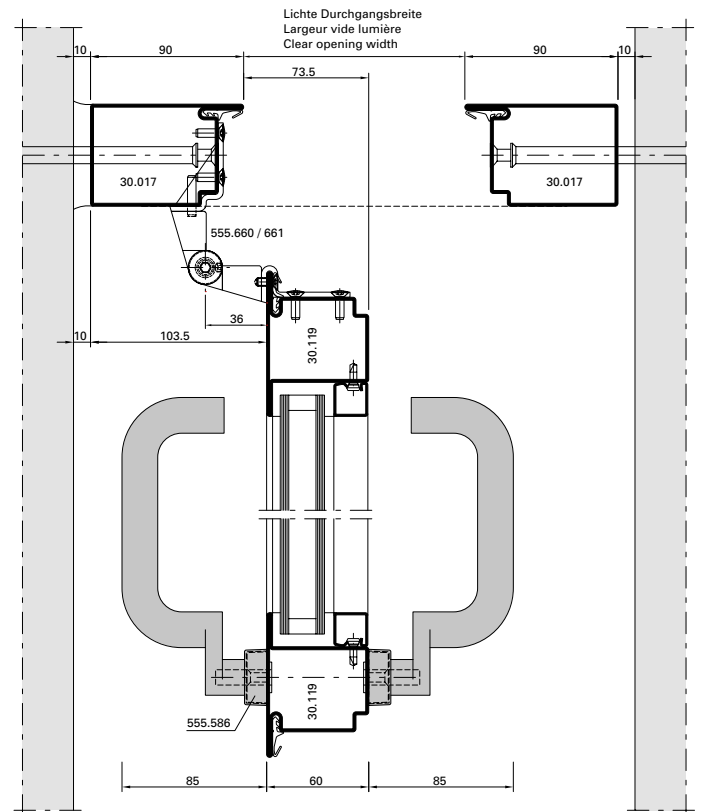

DXF **DWG** *D-250-E-024*

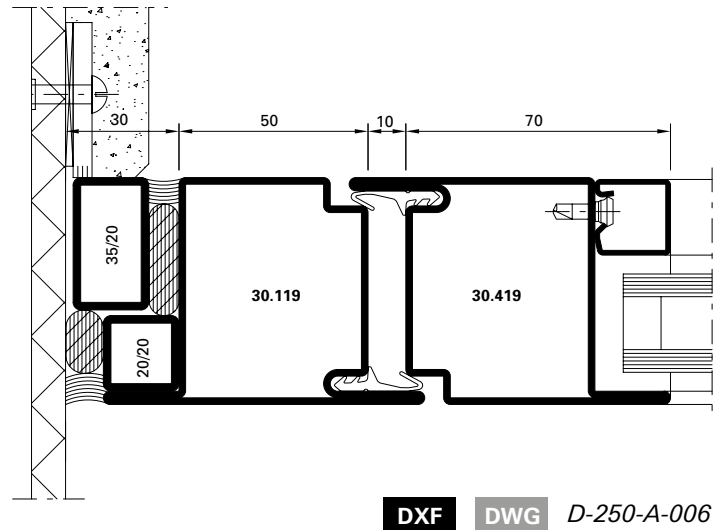
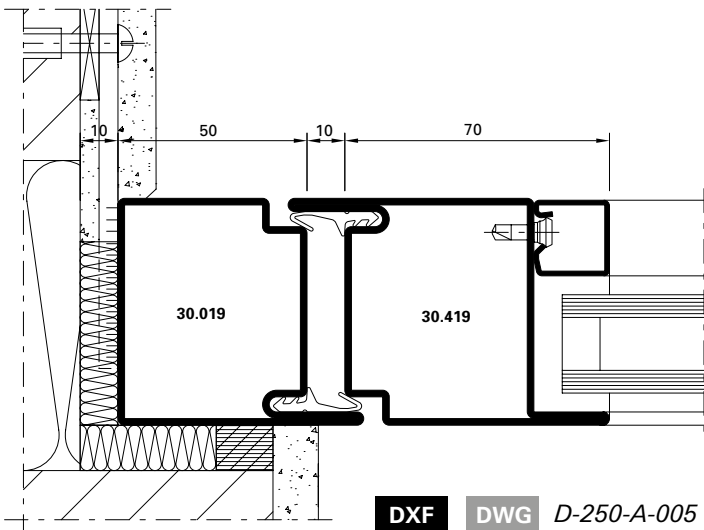
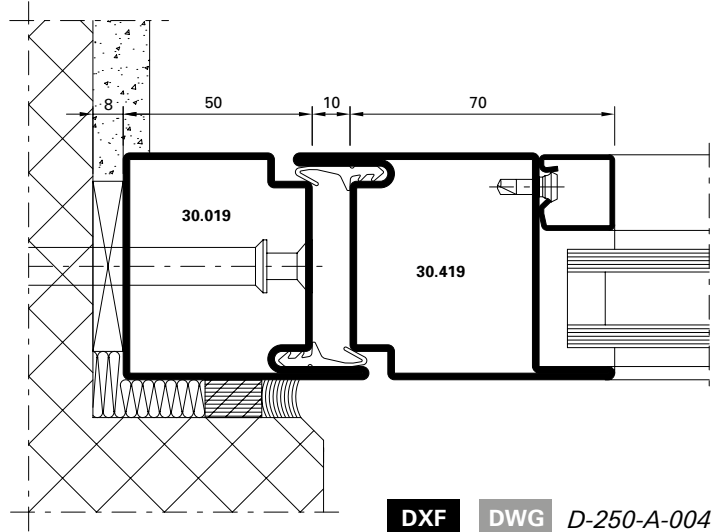
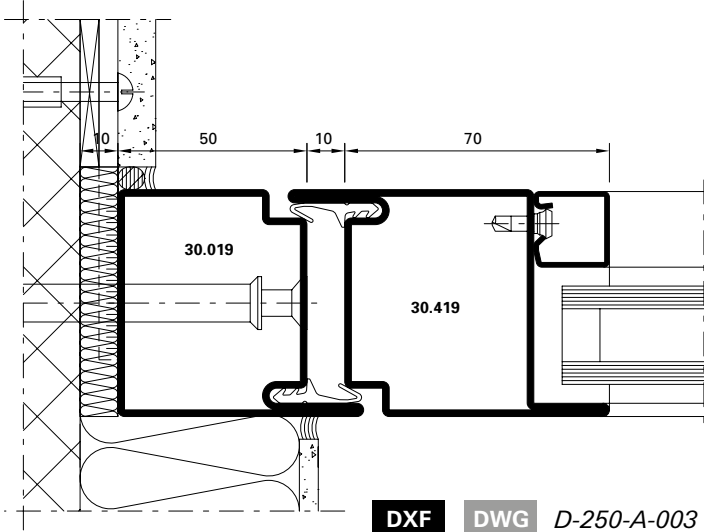
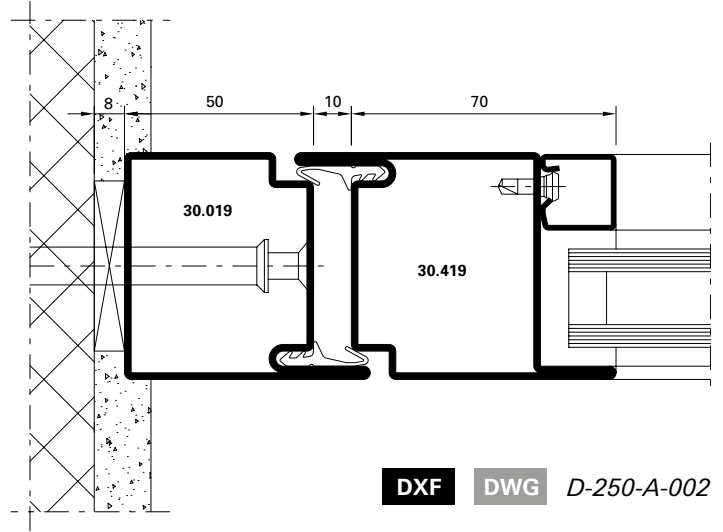
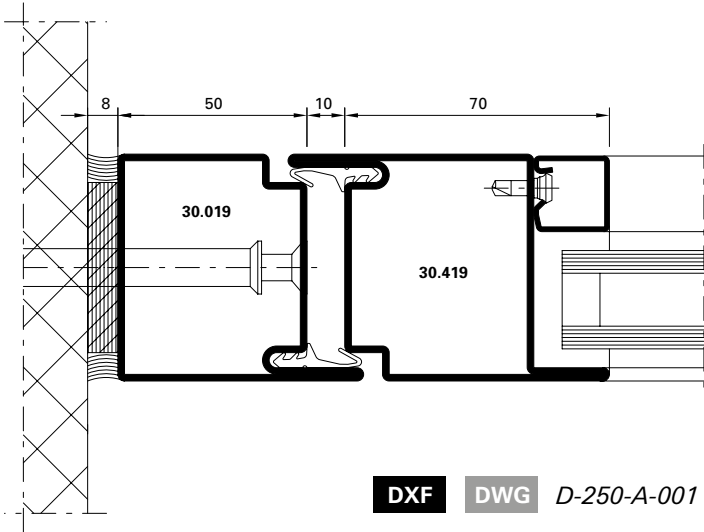

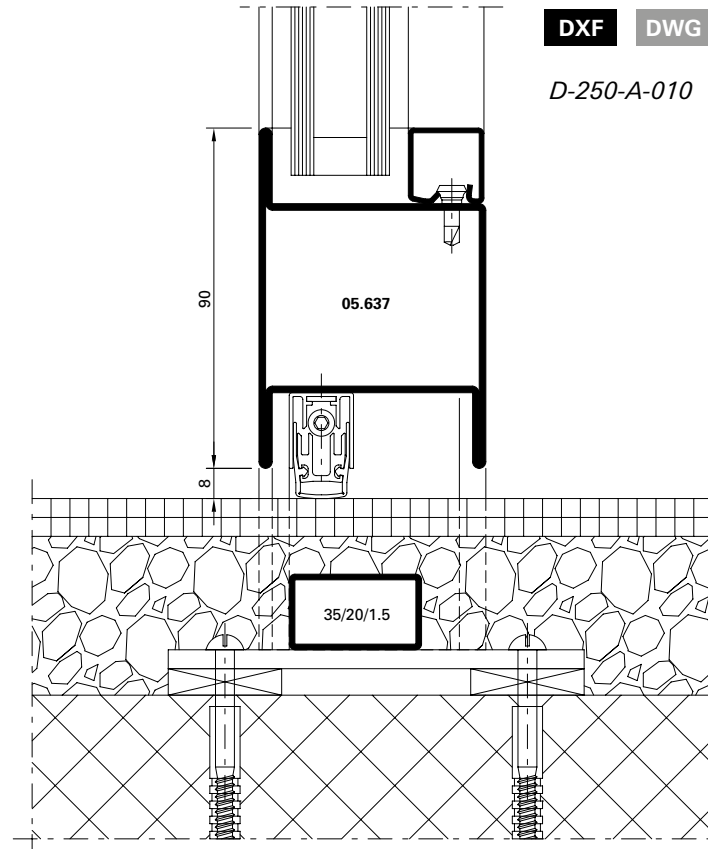
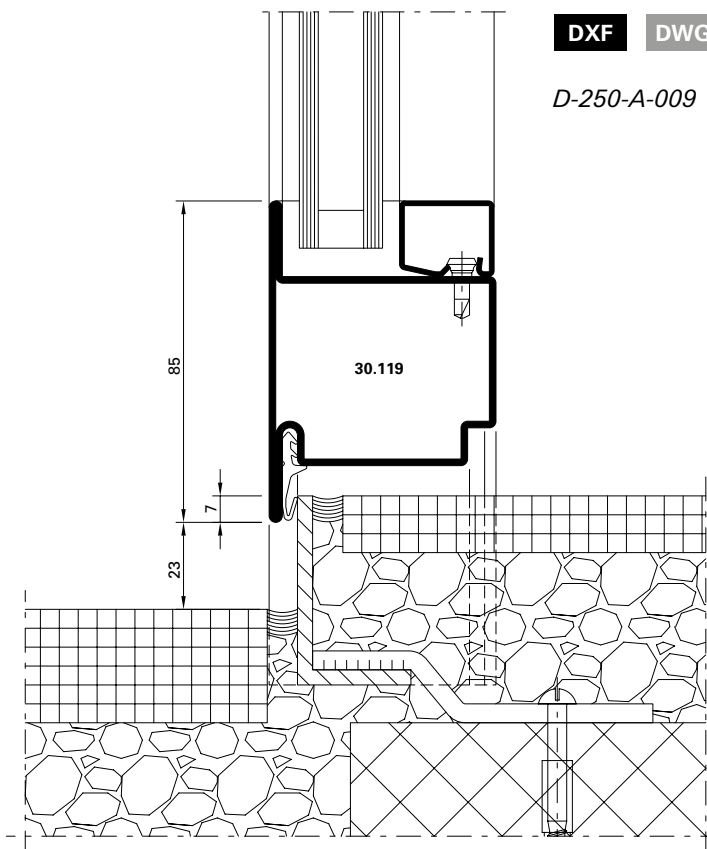
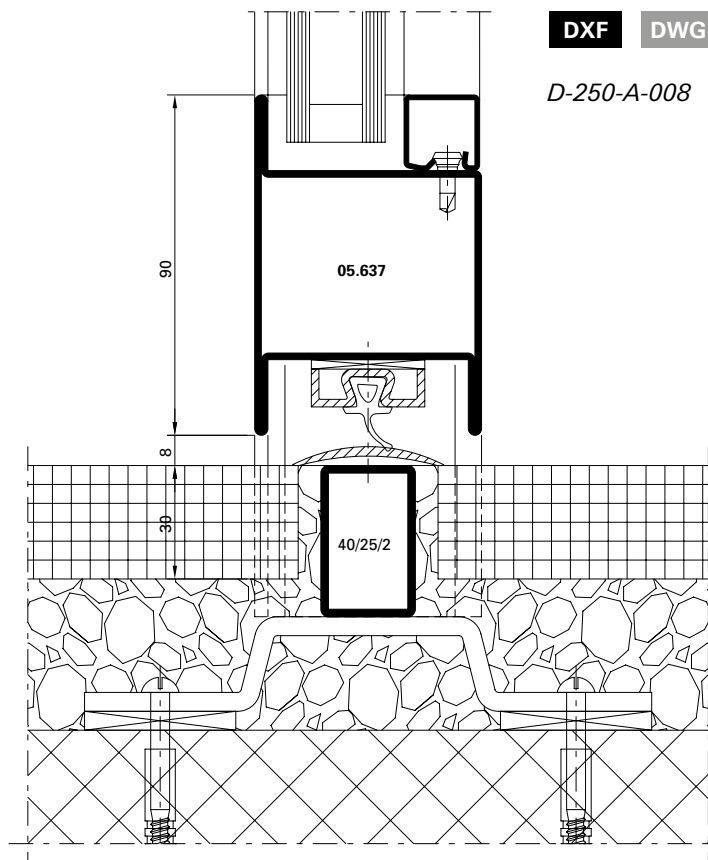
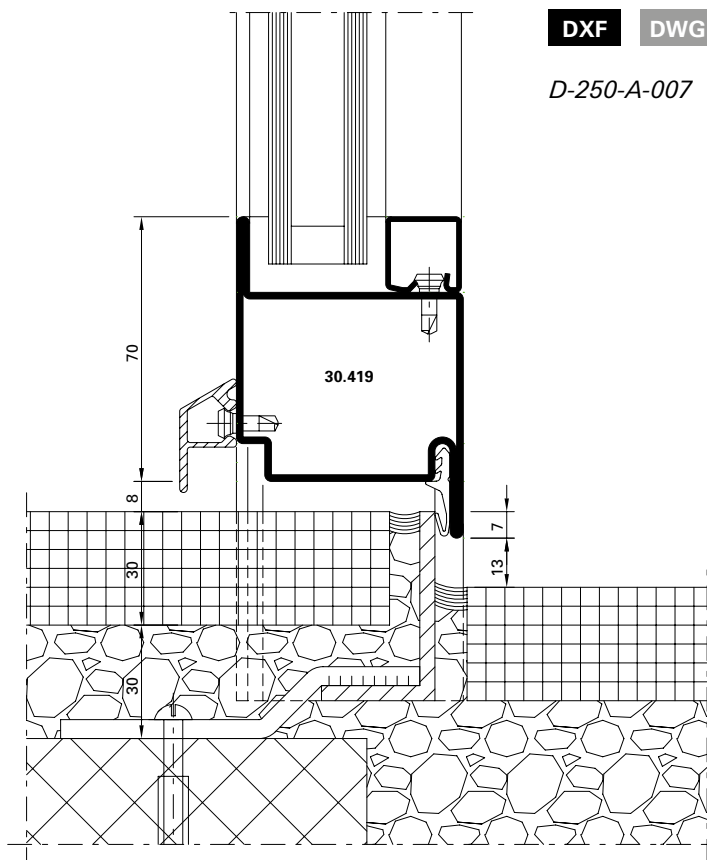



Einflügelige Türen,
 auswärts öffnend,
 Flügelhöhe ≤ 2200 mm

Porte à un vantail,
 ouvrant vers l'extérieur,
 hauteur du vantail ≤ 2200 mm

Single leaf door,
 outward opening,
 leaf height ≤ 2200 mm

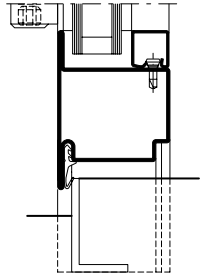
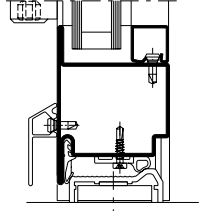
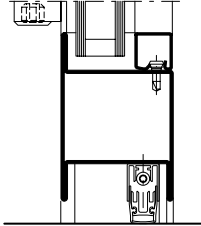
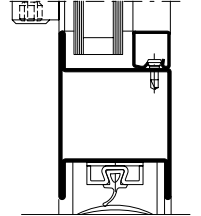
Variante	Beschlag Ferrure Fitting	 EN 12207	 EN 12208	 EN 12210
Anschlagdichtung Joint de butée Rebate gasket 	1	2	1A	C4
	2	2	2A	C4
	3	3	2A	C5
Doppel-Anschlagdichtung Joint de base double Double rebate gasket 	1	4	3A	C4
	2	4	3A	C4
	3	4	5A	C5
Senkdichtung Joint seuil Drop seal 	1	2	1A	C4
	2	2	2A	C4
	3	3	2A	C5
Auflaufdichtung Joint de contact Ramp seal 	1	2	0	C4
	2	2	0	C4
	3	2	0	C5

1 Fallenriegel-Schloss
 Serrure à mortaiser
 Latch and bolt lock





2 Schloss mit Obenverriegelung
 Serrure avec verrouillage supérieur
 Lock with top locking point

3 Mehrfachverriegelungs-Schloss
 Serrure à verrouillage multiple
 Multipoint lock

Einflügelige Türen,
 einwärts öffnend,
 Flügelhöhe ≤ 2200 mm

Porte à un vantail,
 ouvrant vers l'intérieur,
 hauteur du vantail ≤ 2200 mm

Single leaf door,
 inward opening,
 leaf height ≤ 2200 mm

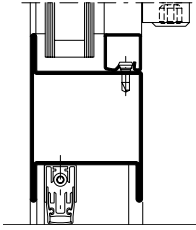
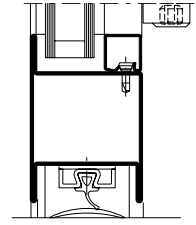
Variante		Beschlag Ferrure Fitting	 EN 12207	 EN 12208	 EN 12210
Senkdichtung Joint seuil Drop seal		❶	2	0	C4
		❷	2	0	C4
		❸	3	1A	C5
Auflaufdichtung Joint de contact Ramp seal		❶	2	0	C4
		❷	2	0	C4
		❸	2	0	C5

❶ Fallenriegel-Schloss
 Serrure à mortaiser
 Latch and bolt lock



❷ Schloss mit Obenverriegelung
 Serrure avec verrouillage supérieur
 Lock with top locking point

❸ Mehrfachverriegelungs-Schloss
 Serrure à verrouillage multiple
 Multipoint lock

Einflügelige Türen,
 auswärts öffnend,
 Flügelhöhe ≤ 3000 mm

Porte à un vantail,
 ouvrant vers l'extérieur,
 hauteur du vantail ≤ 3000 mm

Single leaf door,
 outward opening,
 leaf height ≤ 3000 mm

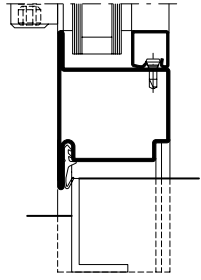
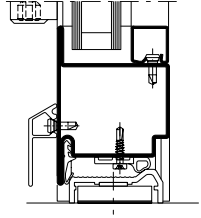
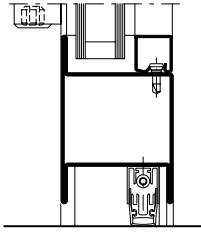
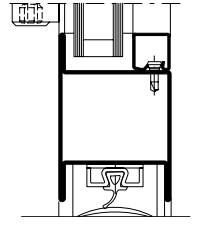
Variante	Beschlag Ferrure Fitting	 EN 12207	 EN 12208	 EN 12210
Anschlagdichtung Joint de butée Rebate gasket 	1	1	0	C1
	2	1	0	C1
	3	1	0	C2
Doppel-Anschlagdichtung Joint de base double Double rebate gasket 	1	1	1A	C1
	2	1	1A	C1
	3	2	2A	C2
Senkdichtung Joint seuil Drop seal 	1	1	0	C1
	2	1	0	C1
	3	1	0	C2
Aufleumdichtung Joint de contact Ramp seal 	1	0	0	C1
	2	0	0	C1
	3	1	0	C2

1 Fallenriegel-Schloss
 Serrure à mortaiser
 Latch and bolt lock





2 Schloss mit Obenverriegelung
 Serrure avec verrouillage supérieur
 Lock with top locking point

3 Mehrfachverriegelungs-Schloss
 Serrure à verrouillage multiple
 Multipoint lock

Einflügelige Türen,
 einwärts öffnend,
 Flügelhöhe ≤ 3000 mm

Porte à un vantail,
 ouvrant vers l'intérieur,
 hauteur du vantail ≤ 3000 mm

Single leaf door,
 inward opening,
 leaf height ≤ 3000 mm

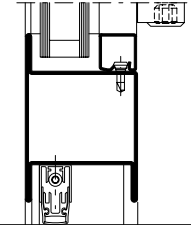
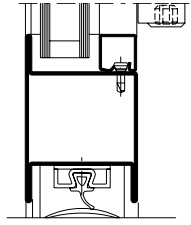
Variante		Beschlag Ferrure Fitting	 EN 12207	 EN 12208	 EN 12210
Senkdichtung Joint seuil Drop seal		❶	1	0	C1
		❷	1	0	C1
		❸	1	0	C2
Auflaufdichtung Joint de contact Ramp seal		❶	0	0	C1
		❷	0	0	C1
		❸	1	0	C2

❶ Fallenriegel-Schloss
 Serrure à mortaiser
 Latch and bolt lock



❷ Schloss mit Obenverriegelung
 Serrure avec verrouillage supérieur
 Lock with top locking point

❸ Mehrfachverriegelungs-Schloss
 Serrure à verrouillage multiple
 Multipoint lock

Zweiflügelige Türen,
 auswärts öffnend,
 Flügelhöhe ≤ 2200 mm

Porte à deux vantaux,
 ouvrant vers l'extérieur,
 hauteur du vantail ≤ 2200 mm

Double leaf door,
 outward opening,
 leaf height ≤ 2200 mm

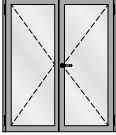
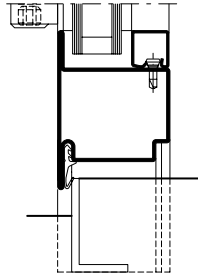
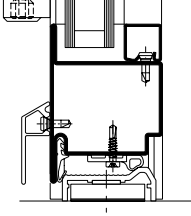
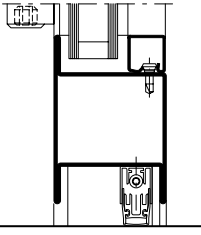
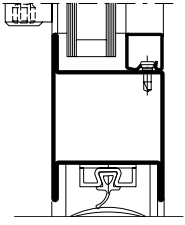
Variante	Beschlag Ferrure Fitting	 EN 12207	 EN 12208	 EN 12210	
					
Anschlagdichtung Joint de butée Rebate gasket		1	2	1A	C2
		2	2	2A	C2
		3	2	2A	C3
Doppel-Anschlagdichtung Joint de base double Double rebate gasket		1	2	2A	C2
		2	2	2A	C2
		3	3	3A	C3
Senkdichtung Joint seuil Drop seal		1	2	1A	C2
		2	2	2A	C2
		3	2	2A	C3
Auflaufdichtung Joint de contact Ramp seal		1	2	0	C2
		2	2	0	C2
		3	2	0	C3

1 Fallenriegel-Schloss
 Serrure à mortaiser
 Latch and bolt lock





2 Schloss mit Obenverriegelung
 Serrure avec verrouillage supérieur
 Lock with top locking point

3 Mehrfachverriegelungs-Schloss
 Serrure à verrouillage multiple
 Multipoint lock

Zweiflügelige Türen,
 einwärts öffnend,
 Flügelhöhe ≤ 2200 mm

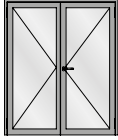
Porte à deux vantaux,
 ouvrant vers l'intérieur,
 hauteur du vantail ≤ 2200 mm

Double leaf door,
 inward opening,
 leaf height ≤ 2200 mm

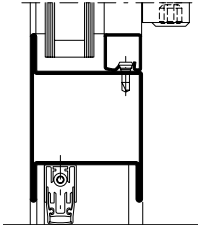
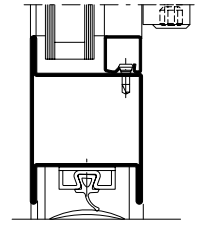
Variante		Beschlag Ferrure Fitting	 EN 12207	 EN 12208	 EN 12210
Senkdichtung Joint seuil Drop seal		❶	2	0	C2
		❷	2	0	C2
		❸	2	0	C3
Auflaufdichtung Joint de contact Ramp seal		❶	2	0	C2
		❷	2	0	C2
		❸	2	0	C3

❶ Fallenriegel-Schloss
 Serrure à mortaiser
 Latch and bolt lock



❷ Schloss mit Obenverriegelung
 Serrure avec verrouillage supérieur
 Lock with top locking point

❸ Mehrfachverriegelungs-Schloss
 Serrure à verrouillage multiple
 Multipoint lock

Zweiflügelige Türen,
 auswärts öffnend,
 Flügelhöhe ≤ 3000 mm

Porte à deux vantaux,
 ouvrant vers l'extérieur,
 hauteur du vantail ≤ 3000 mm

Double leaf door,
 outward opening,
 leaf height ≤ 3000 mm

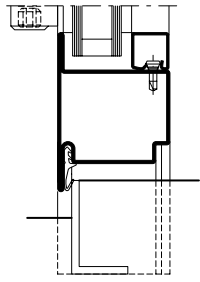
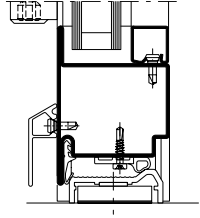
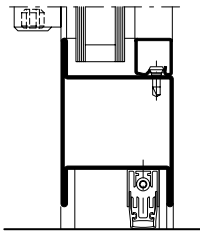
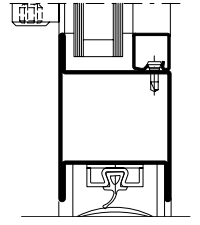
Variante	Beschlag Ferrure Fitting	 EN 12207	 EN 12208	 EN 12210
Anschlagdichtung Joint de butée Rebate gasket 	1 2 3	0	0	C1
		0	0	C1
		1	0	C2
Doppel-Anschlagdichtung Joint de base double Double rebate gasket 	1 2 3	1	0	C1
		1	0	C1
		2	0	C2
Senkdichtung Joint seuil Drop seal 	1 2 3	0	0	C1
		0	0	C1
		1	0	C2
Aufaufdichtung Joint de contact Ramp seal 	1 2 3	0	0	C1
		0	0	C1
		1	0	C2

1 Fallenriegel-Schloss
 Serrure à mortaiser
 Latch and bolt lock





2 Schloss mit Obenverriegelung
 Serrure avec verrouillage supérieur
 Lock with top locking point

3 Mehrfachverriegelungs-Schloss
 Serrure à verrouillage multiple
 Multipoint lock

Zweiflügelige Türen,
 einwärts öffnend,
 Flügelhöhe ≤ 3000 mm

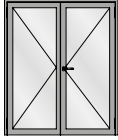
Porte à deux vantaux,
 ouvrant vers l'intérieur,
 hauteur du vantail ≤ 3000 mm

Double leaf door,
 inward opening,
 leaf height ≤ 3000 mm

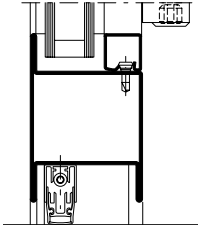
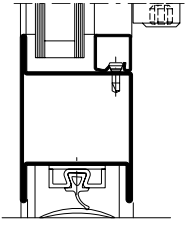
Variante		Beschlag Ferrure Fitting	 EN 12207	 EN 12208	 EN 12210
Senkdichtung Joint seuil Drop seal		1	0	0	C1
		2	0	0	C1
		3	1	0	C2
Auflaufdichtung Joint de contact Ramp seal		1	0	0	C1
		2	0	0	C1
		3	1	0	C2

U_f-Werte
(nach EN ISO 10077-2:2018-01)

Valeurs U_f
(selon EN ISO 10077-2:2018-01)

U_f values
(according to
EN ISO 10077-2:2018-01)

Auf den folgenden Seiten
finden Sie die U_f-Werte für die
verschiedenen Anwendungen von
Jansen-Economy 60.

Vous trouverez les valeurs U_f
pour les différentes applications
Jansen-Economy 60 dans les
pages qui suivent.

On the following pages you
will find the U_f values for the
various applications for
Jansen-Economy 60.

Sie basieren auf folgenden
Grundlagen:

Elles se basent sur les principes
suivants:

They are based on the following:

Stahl

- Profile bandverzinkter Stahl,
unbeschichtet
- Stahl-Glasleisten
- Trockenverglasung
- Nassverglasung

Acier

- Profilés en bande d'acier zingué,
sans revêtement
- Parcloses en acier
- Vitrage à sec
- Vitrage à mastic



Steel

- Strip galvanised steel profiles,
uncoated
- Steel glazing beads
- Glazing with dry glazing
- Glazing with sealing

U_f-Werte
 (nach EN ISO 10077-2:2018-01)

Valeurs U_f
 (selon EN ISO 10077-2:2018-01)

U_f values
 (according to EN ISO 10077-2:2018-01)

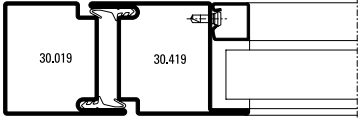
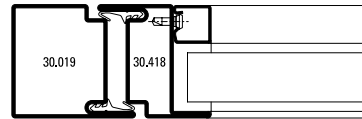
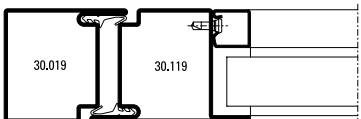
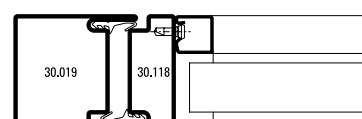
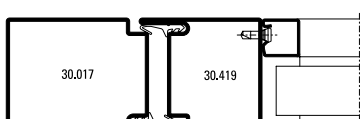
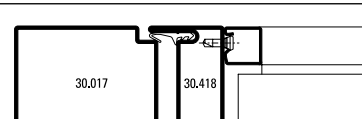
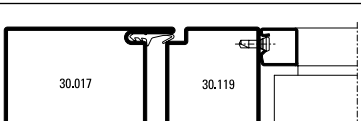
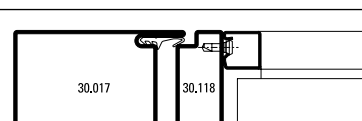
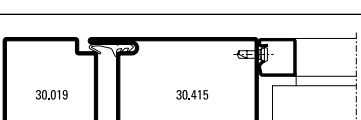
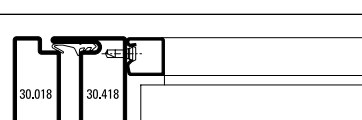
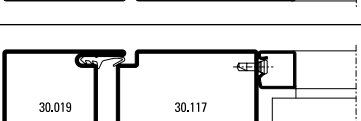
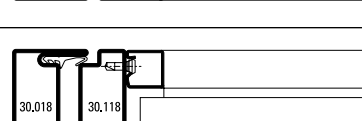
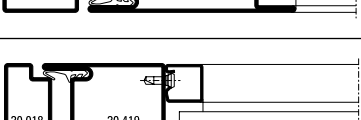
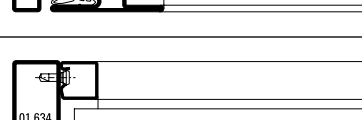
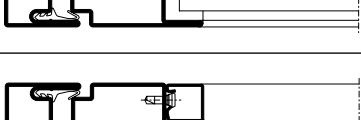
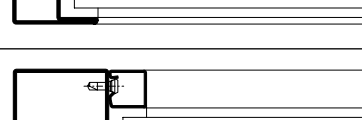
 Füllelementstärken Elements de remplissages Infill elements ≥ 24 mm		 Füllelementstärken Elements de remplissages Infill elements ≥ 24 mm	
	5,5 W/m ² K		5,7 W/m ² K
	5,6 W/m ² K		5,8 W/m ² K
	5,3 W/m ² K		5,5 W/m ² K
	5,3 W/m ² K		5,5 W/m ² K
	5,3 W/m ² K		6,0 W/m ² K
	5,3 W/m ² K		6,1 W/m ² K
	5,6 W/m ² K		6,9 W/m ² K
	5,7 W/m ² K		6,1 W/m ² K

U_f-Werte
 (nach EN ISO 10077-2:2018-01)

Valeurs U_f
 (selon EN ISO 10077-2:2018-01)

U_f values
 (according to EN ISO 10077-2:2018-01)

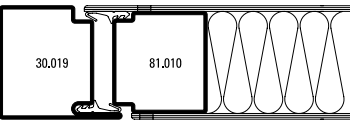
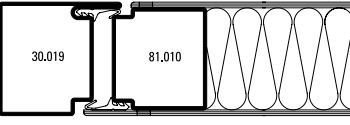
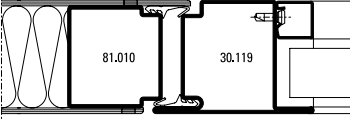
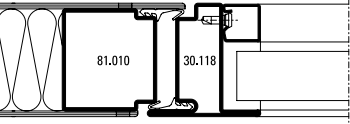
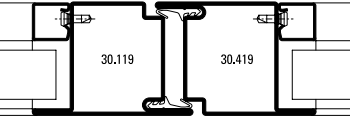
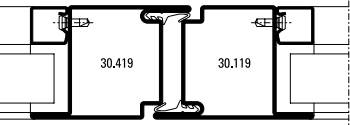
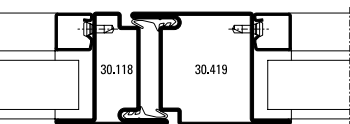
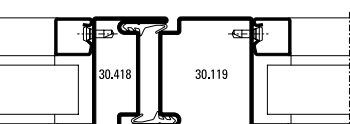

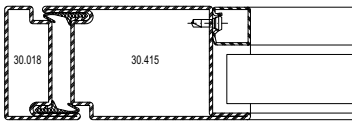
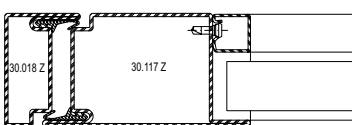
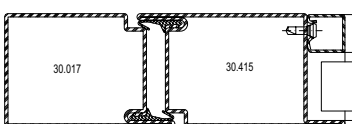
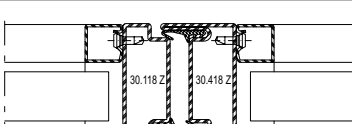
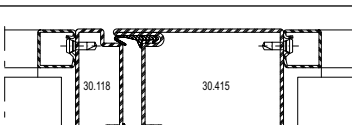
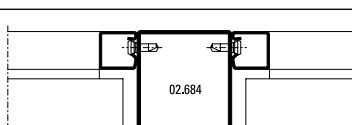
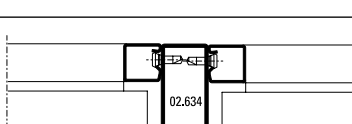
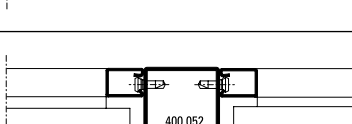
	Füllelementstärken Elements de remplissages Infill elements ≥ 24 mm
	5,3 W/m²K
	5,3 W/m²K
	5,7 W/m²K
	6,0 W/m²K
	5,8 W/m²K
	5,8 W/m²K
	6,1 W/m²K
	6,1 W/m²K

	Füllelementstärken Elements de remplissages Infill elements ≥ 24 mm
	5,3 W/m²K
	5,4 W/m²K
	5,1 W/m²K
	6,5 W/m²K
	5,7 W/m²K
	6,3 W/m²K
	7,2 W/m²K
	6,4 W/m²K

U_f-Werte
 (nach EN ISO 10077-2:2018-01)

Valeurs U_f
 (selon EN ISO 10077-2:2018-01)

U_f values
 (according to EN ISO 10077-2:2018-01)

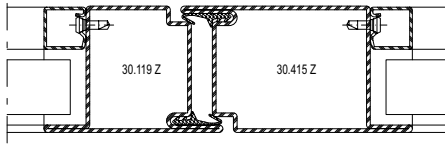
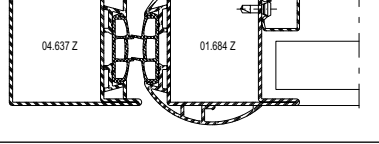
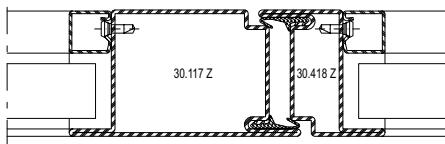
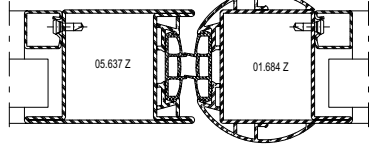
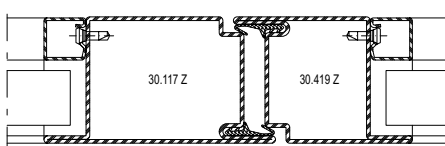
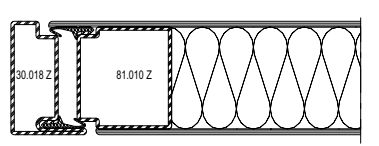
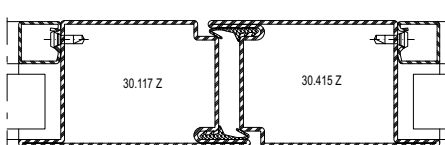
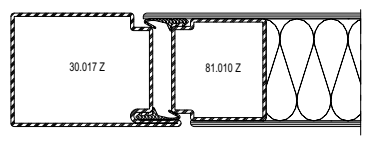
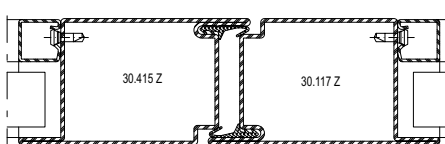
	Füllelementstärken Elements de remplissages Infill elements ≥ 24 mm		Füllelementstärken Elements de remplissages Infill elements ≥ 24 mm
	5,5 W/m²K		5,8 W/m²K
	5,7 W/m²K		6,0 W/m²K
	5,5 W/m²K		5,4 W/m²K
	5,3 W/m²K		5,1 W/m²K
	5,3 W/m²K		

U_f-Werte
 (nach EN ISO 10077-2:2018-01)

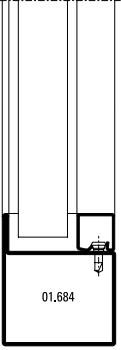
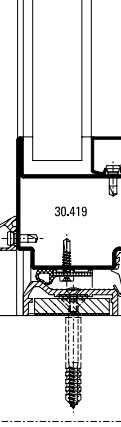
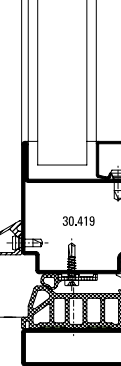
 Füllelementstärken Elements de remplissages Infill elements ≥ 24 mm	
	6,1 W/m ² K
	6,3 W/m ² K
	5,6 W/m ² K

Valeurs U_f
 (selon EN ISO 10077-2:2018-01)

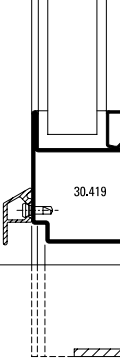
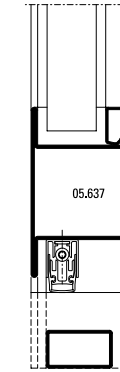
 Füllelementstärken Elements de remplissages Infill elements ≥ 24 mm	
	6,3 W/m ² K
	5,6 W/m ² K

U_f values
 (according to EN ISO 10077-2:2018-01)

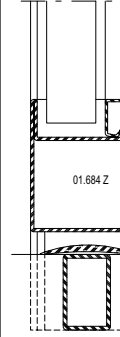
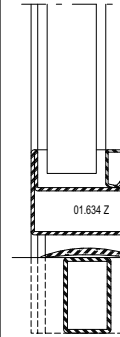
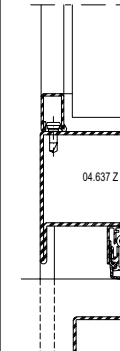
 Füllelementstärken Elements de remplissages Infill elements ≥ 24 mm	
	6,1 W/m ² K
	6,8 W/m ² K
	5,5 W/m ² K

U_f-Werte
 (nach EN ISO 10077-2:2018-01)

Valeurs U_f
 (selon EN ISO 10077-2:2018-01)

U_f values
 (according to EN ISO 10077-2:2018-01)

	Füllelementstärken Elements de remplissages Infill elements ≥ 24 mm
	5,6 W/m ² K

	Füllelementstärken Elements de remplissages Infill elements ≥ 24 mm
	5,6 W/m ² K

	Füllelementstärken Elements de remplissages Infill elements ≥ 24 mm
	5,7 W/m ² K

	4,4 W/m ² K
--	------------------------

	5,7 W/m ² K
--	------------------------

	5,2 W/m ² K
--	------------------------



Schallschutz

Ausführungsvarianten

Die nachfolgende Typenübersicht ergibt einen Überblick über die beurteilten Varianten.

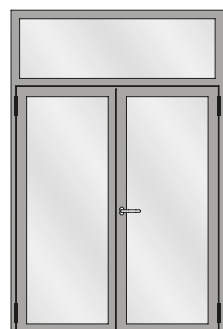
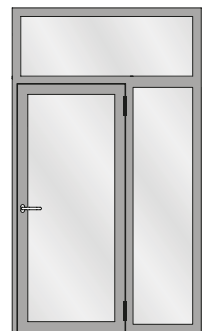
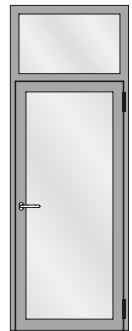
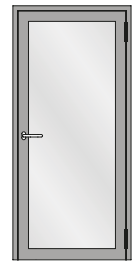

Isolation phonique

Modèles

L'aperçu des types suivant fournit une vue d'ensemble des variantes examinées.

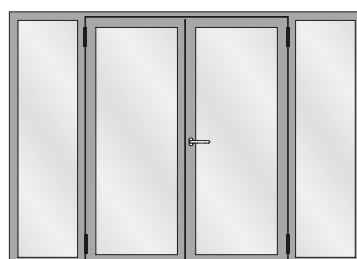
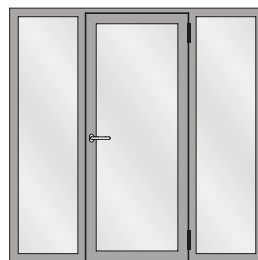
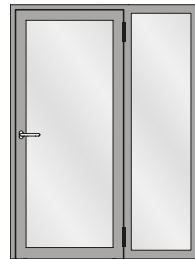
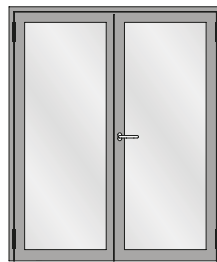

Sound insulation

Design range

The following overview of types provides an overview of the evaluated designs.

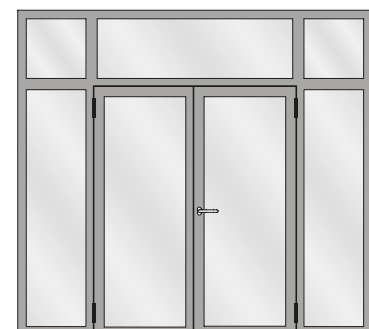
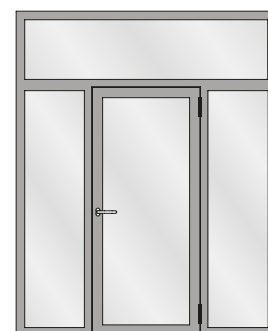

Schallschutz

Isolation phonique

Sound insulation

Tabelle A1

Korrekturtabelle für Jansen-Economy-Türen mit Glasfüllungen

Tableau A1

Tableau de correction pour les portes Jansen-Economy avec vitrage

Table A1

Correction table for Jansen-Economy doors with glass

	1	2	3	4	5	6	7	8	9	10	11
	Türe mit zwei absenkba- ren Bodendichtungen Porte avec deux joint seuil automatique Door with two threshold gaskets that can be lowered	Glas Verre Glass	Korrekturen Corrections Corrections								
	$R_{w(C, Ctr)}$ dB	$R_{w, P, Glas}$ dB	K_S dB	K_{FV} dB	K_{Nass} dB	K_{1aB} dB	$K_{W/S}$ dB	$K_{G 0,4}$ dB	$K_{G 1,8}$ dB	$K_{G 2,6}$ dB	$K_{G 3,2}$ dB
1	32 (-1; -5)	31	0	-1	0	0	0	0	-1	-2	-3
2	33 (-1; -5)	32	0	-1	0	0	0	0	-1	-2	-3
3	35 (-1; -5)	34	0	-1	0	0	0	0	-1	-2	-3
4	36 (-2; -5)	35	0	-1	-1	0	0	0	-1	-2	-3
5	37 (-2; -5)	37	0	0	-1	0	-1	0	-1	-2	-3
6	38 (-2; -5)	39	0	0	-1	-1	-1	0	-1	-2	-3
7	39 (-2; -5)	40	0	0	-1	-1	-1	0	-1	-2	-3
8	40 (-2; -5)	41	0	0	-1	-1	-2	-1	-1	-2	-3
9	41 (-2; -5)	42	0	0	-1	-1	-2	-2	-1	-2	-3
10	42 (-2; -5)	43	-1	0	-1	-1	-2	-2	-1	-2	-3
11	42 (-2; -5)	44	-1	0	-1	-1	-2	-2	-1	-2	-3
12	43 (-2; -5)	45	-1	+1	-1	-1	-3	-3	-1	-2	-3
13	44 (-2; -5)	49	-1	+1	-1	-2	-3	-3	-1	-2	-3

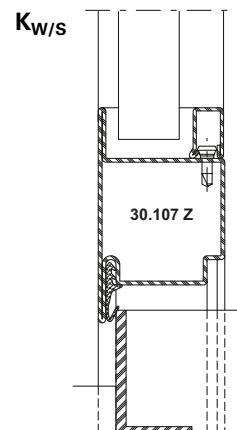
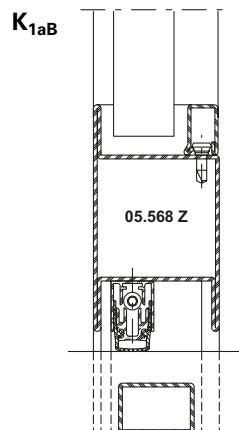
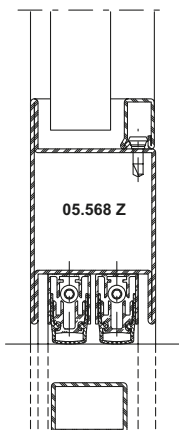

Schallschutz

Der aus der Tabelle A1 abzulesende Wert für die Schalldämmung $R_{w, Tür}$ beträgt:

Isolation phonique

La valeur à relever sur le tableau A1 concernant l'isolement contre les sons aériens $R_{w, Porte}$ est la suivante:

Sound insulation

The value taken from table A1 for the sound insulation $R_{w, Door}$ is:

$$R_{w, Tür} = R_w + K_S + K_{FV} + K_{Nass} + K_{1aB} + K_{W/S} + K_{Band} + K_{G 0,4} + K_{G 1,8} + K_{G 2,6} + K_{G 3,2} \text{ dB}$$

- R_w** bewertetes Schalldämm-Mass der Türe in Abhängigkeit von der Schalldämmung $R_{w,P, Glas}$
- $R_{w,P, Glas}$** bewertetes Schalldämm-Mass der Verglasung (Prüfwert nach ISO 140-3, mit Prüfnachweis einer PÜZ-Stelle). Alternativ können Tabellenwerte nach DIN EN 12758, Abschnitt 6 verwendet werden
- K_S** Korrekturwert für zweiflügelige Türen
- K_{FV}** Korrekturwert für Festverglasungen mit erhöhtem Scheibenanteil
- K_{Nass}** Korrekturwert für Nassverglasung
- K_{1aB}** Korrekturwert für Türen mit einer absenkbaren Bodendichtung
- K_{Band}** Korrekturwert bei Verwendung von Anschlagbändern, die eine Dichtungsebene unterbrechen ($K_{Band} = - 0,5 \text{ dB pro Band}$)
- $K_{W/S}$** Korrekturwert für Türen mit einer Anschlagsschwelle
- $K_{G 0,4}$** Korrekturwert für Einzelscheiben mit einer Glasfläche $\leq 0,4 \text{ m}^2$. Die Korrektur gilt auch für Konstruktionen mit glasteilenden Sprossen.
- $K_{G 1,8}$** Korrekturwert für Einzelscheiben mit einer Glasfläche $\geq 1,8 \text{ m}^2$
- $K_{G 2,6}$** Korrekturwert für Einzelscheiben mit einer Glasfläche $\geq 2,6 \text{ m}^2$
- $K_{G 3,2}$** Korrekturwert für Einzelscheiben mit einer Glasfläche $\geq 3,2 \text{ m}^2$

- R_w** Mesure d'isolement contre les sons aériens des portes évaluée suivant l'isolement phonique $R_{w,P, Glas}$
- $R_{w,P, Glas}$** Cote d'isolement acoustique du vitrage évalué (valeur contrôlée selon ISO 140-3 avec certificat d'un bureau de contrôle, de surveillance ou de certification). Il est également possible d'utiliser les valeurs selon le tableau DIN EN 12758, section 6
- K_S** Valeur de correction pour portes à deux vantaux
- K_{FV}** Valeur de correction pour vitrages fixes à fort pourcentage de vitre
- K_{Nass}** Valeur de correction pour vitrage avec mastic
- K_{1aB}** Valeur de correction pour portes avec un joint seuil automatique
- K_{Band}** Valeur corrective en cas d'utilisation de paumelles qui interrompent un plan d'étanchéité ($K_{Band} = - 0,5 \text{ dB par paumelle}$)
- $K_{W/S}$** Valeur de correction pour portes avec un seuil de butée
- $K_{G 0,4}$** Valeur de correction pour vitres individuelles avec une surface vitrée $\leq 0,4 \text{ m}^2$. La correction s'applique aussi aux constructions à meneaux séparant les vitres.
- $K_{G 1,8}$** Valeur de correction pour vitres individuelles avec surface vitrée $\geq 1,8 \text{ m}^2$
- $K_{G 2,6}$** Valeur de correction pour vitres individuelles avec surface vitrée $\geq 2,6 \text{ m}^2$
- $K_{G 3,2}$** Valeur de correction pour vitres individuelles avec surface vitrée $\geq 3,2 \text{ m}^2$

- R_w** Airborne sound reduction index of doors depending on the sound insulation $R_{w,P, Glas}$
- $R_{w,P, Glas}$** Airborne sound reduction index (test value in accordance with ISO 140-3, with a test certificate from a recognised testing, inspection or certification body). Alternatively, the tabulated values in DIN EN 12758, Section 6 may be used
- K_S** Correction value for double-leaf doors
- K_{FV}** Correction value for fixed glazing with increased proportion of pane
- K_{Nass}** Correction value for glazing with sealing
- K_{1aB}** Correction value for doors with a threshold gasket that can be lowered
- K_{Band}** Correction value when using hinges that interrupt a sealing plane ($K_{Band} = - 0.5 \text{ dB per hinge}$)
- $K_{W/S}$** Correction value for doors with a rebate threshold
- $K_{G 0,4}$** Correction value for single panes with a glass area $\leq 0,4 \text{ m}^2$. The correction also applies to buildings with glazing bars
- $K_{G 1,8}$** Correction value for single panes with a glass area $\geq 1,8 \text{ m}^2$
- $K_{G 2,6}$** Correction value for single panes with a glass area $\geq 2,6 \text{ m}^2$
- $K_{G 3,2}$** Correction value for single panes with a glass area $\geq 3,2 \text{ m}^2$

Jansen AG

Steel Systems
Industriestrasse 34
9463 Oberriet
Schweiz
jansen.com

JANSEN
METALFORM

Jansen-Economy 60 Türen

Türen aus Stahl

Portes Jansen-Economy 60

Portes en acier

Jansen-Economy 60 doors

Doors in steel

Grafische Planungsdaten wie z.B. Anwendungsbeispiele, Konstruktionsdetails, Anschlüsse am Bau, die in unseren physischen oder elektronischen Dokumentationsunterlagen enthalten sind, sind schematische Darstellungen. Gleiches gilt für digitale Medien wie CAD Dateien oder BIM Modelle.

Sie sollen den ausführenden Metallbauer und/oder Fachplaner bei der Planung und Ausführung eines Projektes unterstützen. Sie sind im konkreten Anwendungsfall durch den ausführenden Metallbauer und/oder Fachplaner auf die Verwendbarkeit im konkreten betroffenen Projekt hinsichtlich rechtlichen/regulatorischen aber auch technischen objektspezifischen Anforderungen zu überprüfen und ggfs. eigenverantwortlich anzupassen.

Bei der Überprüfung, der spezifischen Planung und der Umsetzung sind die objektspezifischen Rahmenbedingungen (Material der Bausubstanz, Dimension des Einbauelements, Farbe, Exposition, Lasteinwirkung, etc.) sowie der geltende Stand der Technik einschliesslich aller anwendbaren Normen und technischen Richtlinien eigenverantwortlich zu beachten.

Falls das vorliegende Dokument Differenzen zur aktuellen deutschen Version (Artikel Nr. K1214237) aufweist, gilt in jedem Fall der deutsche Originaltext in der jeweils geltenden Fassung im Jansen Docu Center.

Alle Ausführungen dieser Dokumentation haben wir sorgfältig und nach bestem Wissen zusammengestellt. Wir können aber keine Verantwortung für die Benutzung der vermittelten Vorschläge und Daten übernehmen. Wir behalten uns technische Änderungen ohne Vorankündigung vor.

Les données de planification graphiques, comme les exemples d'application, détails de construction et raccordements au bâtiment, fournies dans notre documentation physique et numérique sont des représentations schématiques. Il en va de même pour les médias numériques comme les fichiers CAD ou modèles BIM.

Leur but est de faciliter la planification et réalisation d'un projet par les constructeurs métalliques et/ou concepteurs. Concrètement, elles doivent être vérifiées par le constructeur métallique et/ou le concepteur et, le cas échéant, modifiées de son propre chef pour s'assurer qu'elles concordent avec le projet concerné et qu'elles répondent aux exigences techniques spécifiques ainsi qu'aux dispositions légales et réglementaires.

Lors de la vérification, de la planification spécifique et de la mise en œuvre, il y a lieu de tenir compte des conditions spécifiques à l'objet (matériaux du bâtiment, dimension de l'élément d'insert, couleur, exposition, effet de charge, etc.) ainsi que de l'état actuel de la technique, y compris toutes les normes et directives techniques applicables.

En cas de divergence entre le présent document et la version allemande (no d'article K1214237), c'est dans tous les cas le texte original allemand qui prévaut dans sa version actuelle disponible dans le Jansen Docu Center.

Nous avons apporté le plus grand soin à l'élaboration de cette documentation. Cependant, nous déclinons toute responsabilité pour l'utilisation faite de nos propositions et de nos données.

Nous nous réservons le droit de procéder à des modifications techniques sans préavis.

Graphical planning data such as application examples, construction details, connections on site that are contained in our physical or electronic documentation components are schematic representations. The same applies to digital media such as CAD files or BIM models.

They are intended to support the metal worker and/or design engineer in planning and executing projects. In the specific case of application they are to be checked by the metal worker and/or design engineer in terms of their usability in the specific project concerned with regard to legal/regulatory and technical property-specific requirements and adjusted if necessary at the latter's own responsibility.

The property-specific underlying conditions (construction material, dimensions of installation element, colour, exposure, load effect etc.) and current state of the art including all applicable norms and technical guidelines are to be taken into consideration at the metal worker and/or design engineer's own responsibility during the review, specific planning and implementation.

If there are any differences between this document and the current German version (item number K1214237), the latest version of the original German text in the Jansen Docu Center shall prevail.

All the information contained in this documentation is given to the best of our knowledge and ability. However, we decline all responsibility for the use made of these suggestions and data.

We reserve the right to effect technical modifications without prior warning.

Inhaltsverzeichnis Sommaire Content	Jansen-Economy 60 Türen Jansen-Economy 60 portes Jansen-Economy 60 doors	2	
Systemübersicht Merkmale Leistungseigenschaften Systemausführungen Typenübersicht	Sommaire du système Caractéristiques Caractéristiques de performance Exécutions de système Sommaire des types	Summary of system Characteristics Performance characteristics System versions Summary of types	2
Profilsortiment	Assortiment de profilé	Range of profiles	14
Beispiele Schnittpunkte Konstruktionsdetails Anschlüsse am Bau	Exemples Coupes de détails Détails de construction Raccords au mur	Examples Section details Construction details Attachment to structure	18
Leistungseigenschaften	Caractéristiques de performance	Performance characteristics	36

Merkmale
Caractéristiques
Characteristics

Jansen-Economy 60 Türen
Jansen-Economy 60 portes
Jansen-Economy 60 doors







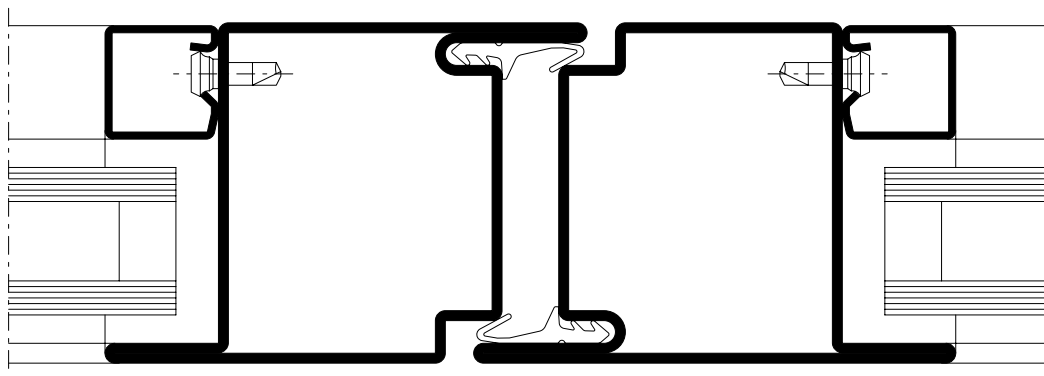

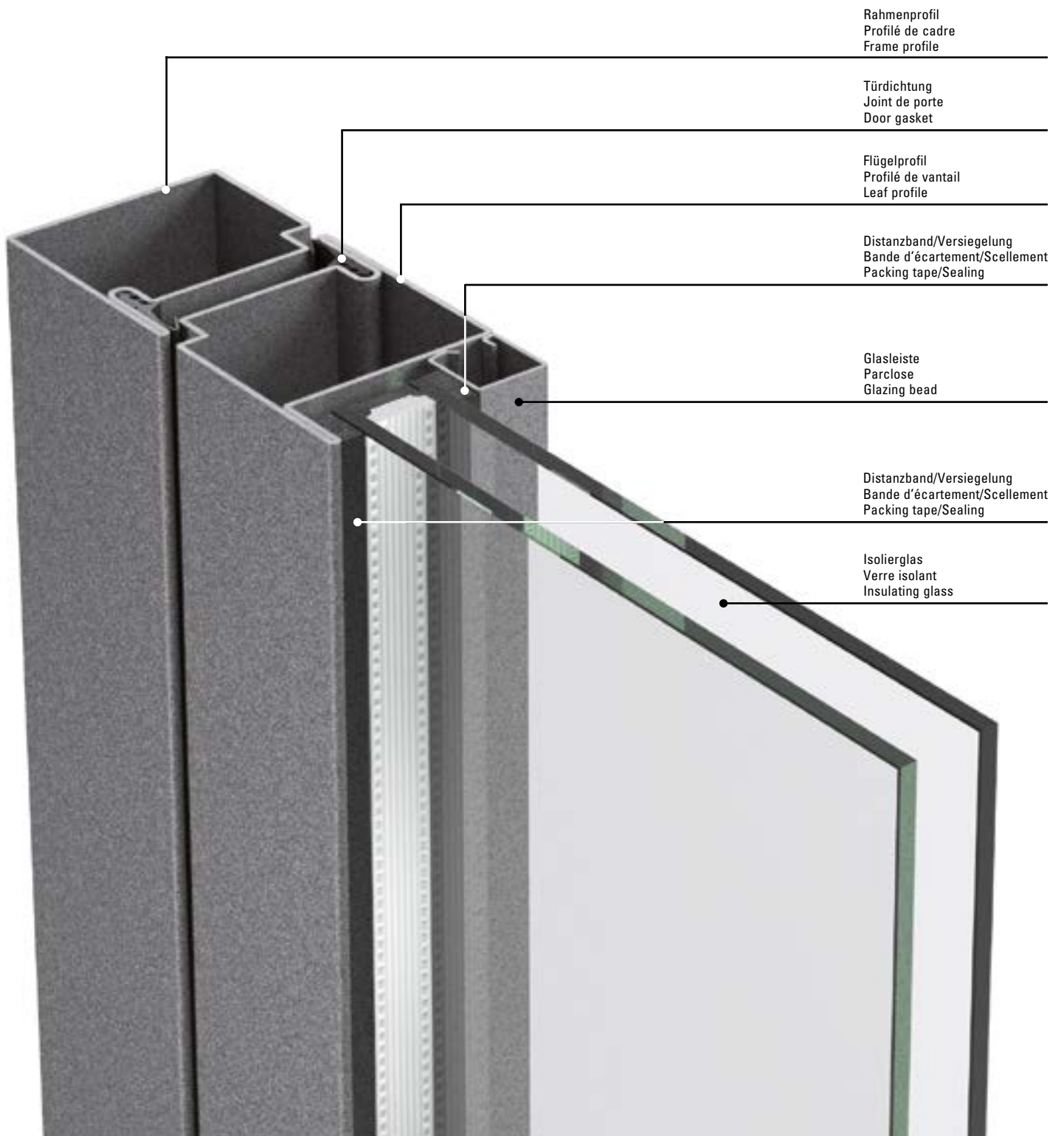

- Stahlsystem für Türen und Festverglasungen
- Bautiefe 60 mm, innen und aussen flächenbündig
- Schmale Ansichtsbreiten: Rahmen und Flügel ab 105 mm Stulppartie 150 mm
- Ein- und zweiflüglige Türen, nach innen und aussen öffnend, mit Oberlicht oder Festverglasung kombinierbar
- Türflügel bis 1465 x 3000 mm (BxH), Flügelgewicht bis 230 kg
- Füllelementstärke von 5 bis 36 mm, Glaseinbau mittels Trocken- oder Nassverglasung
- Systemprüfungen nach Produktnorm EN 14351-1
- Stahlprofile blank oder bandverzinkt
- Grosses Sortiment an systemgeprüften Türbeschlägen
- Barrierefreie Schwellenausbildungen
- Geeignet für Pulver- und Nasslackbeschichtungen

- Système en acier pour portes et vitrages fixes
- Profondeur de montage 60 mm, montage à fleur à l'intérieur et à l'extérieur
- Fines largeurs de face: Cadre et vantaux à partir de 105 mm Partie tête 150 mm
- Portes à un et deux vantaux, ouverture vers l'intérieur et vers l'extérieur, combinables avec imposte ou vitrage fixe
- Vantaux de porte jusqu'à 1465 x 3000 mm (LaxH), poids du vantail jusqu'à 230 kg
- Élément de remplissage de 5 à 36 mm d'épaisseur, Montage du vitrage à sec ou à silicone
- Contrôles des systèmes selon la norme produit EN 14351-1
- Profilés en acier brut ou galvanisé en continu
- Grand assortiment de ferrures de porte homologuées
- Formes de seuil sans barrière
- Convient aux revêtements par poudre ou peinture liquide

- Steel system for doors and fixed glazing
- 60 mm basic depth, flush-fitted on the inside and outside
- Narrow face widths: Frame and leaf from 105 mm Meeting stile assembly 150 mm
- Single and double-leaf doors, inward and outward-opening, can be combined with toplight or fixed glazing
- Door leaf up to 1465 x 3000 mm (WxH), leaf weight up to 230 kg
- Infill unit thickness of 5 to 36 mm, Glazing installed by means of dry or wet glazing
- System tests in accordance with the product standard EN 14351-1
- Raw finish or pre-galvanised steel profiles
- Large range of system-tested door fittings
- Easy-access thresholds
- Suitable for powder and wet paint coating





Norm	Eigenschaft Caractéristique Characteristic	Klassifizierung/Wert Classification / Valeur Classification / Value											
 EN 12210	Widerstandsfähigkeit bei Windlast Résistance à la pression du vent Resistance to wind load	npd	1 (400)	2 (800)	3 (1200)	4 (1600)	5 (2000)	Exxx (>2000)					
 EN 12208	Schlagregendichtheit Etanchéité à la pluie battante Watertightness	npd	1A (0)	2A (50)	3A (100)	4A (150)	5A (200)	6A (250)	7A (300)	8A (450)	9A (600)	Exxx (>750)	
 EN ISO 10140	Schalldämmung R_w (C, C_{tr}) (dB) Isolation phonique R_w (C, C_{tr}) (dB) Sound insulation R_w (C, C_{tr}) (dB)	npd	bis R_w 44 dB (-2; -5) jusqu'à R_w 44 dB (-2; -5) up to R_w 44 dB (-2; -5)										
 EN ISO 10077-2	Wärmedurchgangskoeffizient U_f (W/(m ² ·K)) Transmission thermique U_f (W/(m ² ·K)) Thermal production U_f (W/(m ² ·K))	npd	ab 5.65 W/m ² K à partir de 5.65 W/m ² K from 5.65 W/m ² K										
 EN 12207	Luftdurchlässigkeit Perméabilité à l'air Air permeability	npd	1 (150)		2 (300)		3 (600)		4 (600)				
 EN 1192	Klassifizierung der Festigkeitsanforderungen Classification des exigences de résistance méca. Classification of strength requirements	npd	1		2		3		4				
 EN 1627	Einbruchhemmung Anti-effraction Burglar resistance	npd	1		2		3		4		5		6
 EN 1522	Durchschusshemmung Résistance aux balles Bullet proofing	npd	FB1	FB2	FB3	FB4	FB5	FB6	FB7	FSG			
 EN 1191 EN 1603	Dauerfunktionsprüfung Durabilité mécanique Mechanical durability	D	1 5'000	2 10'000	3 20'000	4 50'000	5 100'000	6 200'000	7 500'000	8 1'000'000			
 EN 179 EN 1125	Fähigkeit zur Freigabe Capacité au déclenchement Ability to release		Anforderung erfüllt Exigence remplie Requirement fulfilled										

Norm	Eigenschaft Caractéristique Characteristic	Klassifizierung/Wert Classification / Valeur Classification / Value			
 EN 12217	Bedienkräfte Forces de manœuvre Operating forces	npd	0	1	2
 EN 1634-3 DIN 18095	Rauchschutz Étanchéité à la fumée Smoke control	S _a / S ₂₀₀ / RS			
 EN 16034 EN 13501-2	Selbstschliessung Fermeture automatique Self-closing	C			
 EN 16034	Dauerhaftigkeit der Selbstschliessung gegenüber Alterung (Korrosion) Endurance de la fermeture automatique contre le vieillissement (corrosion) Durability of self-closing against ageing (corrosion)	erzielt atteinte achieved			



Einbruchhemmende Jansen-Economy 60 Türen

- Türflügelgrößen 1465 x 3000 mm
- Ein- und zweiflügelige Türen, nach innen und aussen öffnend
- Geprüft nach EN 1627
- Panik- und Normalausführung

Portes anti-effraction Jansen-Economy 60

- Dimensions de vantail de porte 1465 x 3000 mm
- Portes à un/deux vantaux à ouverture vers l'intérieur et l'extérieur
- Contrôlé selon la norme EN 1627
- Exécution panique et exécution normale

Burglar-resistant Jansen Economy 60 doors

- Door leaf sizes 1465 x 3000 mm
- Single and double-leaf doors, inward and outward opening
- Tested in accordance with EN 1627
- Panic and standard design



Durchschusshemmende Jansen-Economy 60 Türen

- Türflügelgrößen 1465 x 3000 mm
- Ein- und zweiflügelige Türen, nach innen und aussen öffnend
- Geprüft nach EN 1522

Portes pare-balles Jansen-Economy 60

- Dimensions de vantail de porte 1465 x 3000 mm
- Portes à un/deux vantaux à ouverture vers l'intérieur et l'extérieur
- Contrôlé selon la norme EN 1522

Bullet-resistant Jansen Economy 60 doors

- Door leaf sizes 1465 x 3000 mm
- Single and double-leaf doors, inward and outward opening
- Tested in accordance with EN 1522



Fluchttürsysteme

- Verschlussystem für Notausgangstüren nach EN 179
- Verschlussystem für Paniktüren nach EN 1125
- Barrierefreie Türen ohne Schwelle für behindertengerechtes Bauen
- Ein- und zweiflügelige Türen nach innen und aussen öffnend
- Türflügelgrößen bis 1465 x 3000 mm und Flügelgewicht bis 230 kg

Systèmes de porte de secours

- Système de fermeture pour portes de secours selon EN 179
- Système de fermeture pour portes panique selon EN 1125
- Portes sans seuil pour faciliter l'accès aux personnes handicapées
- Portes à un/deux vantaux à ouverture vers l'intérieur et l'extérieur
- Dimensions de vantail de porte jusqu'à 1465 x 3000 mm et poids de vantail jusqu'à 230 kg

Emergency exit systems

- Closing system for emergency exit doors in accordance with EN 179
- Closing system for panic doors in accordance with EN 1125
- Barrier-free doors without threshold for accessible buildings
- Single and double-leaf doors, inward and outward opening
- Door leaf sizes up to 1465 x 3000 mm and leaf weight up to 230 kg



Jansen-Economy 60 Fingerschutzüren

- Keine Quetsch- und Scherstellen nach DIN 18650
- Wartungsarme Bandlager unten und oben
- Geeignet für Gebäude mit starkem Publikumsverkehr
- Geprüft nach EN 14351-1

Portes anti-pince-doigts Jansen-Economy 60

- Absence de zones d'écrasement et de cisaillement selon DIN 18650
- Paliers de paumelle inférieur et supérieur exigeant peu de maintenance
- Adapté à des bâtiments publics fortement fréquentés
- Contrôlé selon la norme EN 14351-1

Jansen Economy 60 anti-finger-trap doors

- No crushing and shearing points as per DIN 18650
- Low-maintenance hinge bush at top and bottom
- Suitable for buildings subject to frequent use by the public
- Tested in accordance with EN 14351-1



Verblechte Jansen-Economy 60 Türen

- Flächenbündig verblechte Türen
- Geschweisst oder geklebt
- Nach innen und aussen öffnend
- Mit Glasausschnitt möglich

Portes tôlées Jansen-Economy 60

- Portes tôlées à fleur
- Soudées ou collées
- Ouverture vers l'intérieur et l'extérieur
- Panneau de verre possible

Jansen Economy 60 sheet metal doors

- Flush-fitted sheet metal doors
- Welded or bonded
- Inward and outward-opening
- Can have glass vision panel



Jansen-Economy 60 Faltwand

- Nach innen und aussen öffnend
- Leichtgängige, geräuscharme Bedienung
- Schwellenlose Ausführung
- Flügelgewichte bis 100 kg

Porte repliable Jansen-Economy 60

- Ouverture vers l'intérieur et l'extérieur
- Mobilité silencieuse
- Exécution sans seuil
- Poids de vantail jusqu'à 100 kg

Jansen Economy 60 folding wall

- Inward and outward-opening
- Smooth and quiet operation
- Design without a threshold
- Vent weights up to 100 kg

Jansen Docu Center

Die Plattform zum effizienten Arbeiten mit Jansen Dokumentationen. Im Jansen Docu Center stehen alle Produktinformationen jederzeit digital in der aktuellsten Version zur Verfügung: von Architekten-Informationen über Bestell- und Fertigungskatalogen bis hin zu Anleitungen und Prospekten sowie Videos.

Die Inhalte können einfach und schnell aufgerufen werden. Ein für den Anwender komfortables papierloses Arbeiten, das zahlreiche Vorteile bietet.

Download CAD Daten

DXF

DWG

Sie können die Zeichnungen in den Formaten DXF und/oder DWG herunterladen. Klicken Sie auf das entsprechende Icon und der Download erfolgt.

Die Hinweise «Artikelbibliothek/Türbeschläge/Fensterbeschläge» bedeuten, dass Sie mit einem Klick die gesamte Artikelbibliothek des entsprechenden Systems herunterladen (Profile, Beschläge, Glasleisten, Zubehör etc.).

Info und Beratung

Gerne beraten wir Sie persönlich und stehen Ihnen bei Fragen zur Verfügung. Bitte schreiben Sie uns Ihre Anliegen an: info@jansen.com

Jansen Docu Center

La plate-forme pour travailler efficacement avec les documentations Jansen. Le Jansen Docu Center met à votre disposition les informations sur les produits, en format numérique et dans une version actualisée: des catalogues de commande et de fabrication aux instructions et prospectus, en passant par les informations destinées aux architectes et vidéos.

Les contenus sont facilement et rapidement accessibles. Une manière de travailler confortable et offrant de nombreux avantages.

Télécharger fichiers DAO

DXF

DWG

Vous pouvez télécharger les dessins aux formats DXF et/ou DWG. Cliquez sur l'icône correspondante et le téléchargement s'effectuera.

Les indications «Bibliothèque des articles/Ferures de porte/Ferrures de fenêtres» signifie que vous téléchargez la totalité de la bibliothèque des articles du système donné (profilés, ferrures, parclozes, accessoires etc.).

Info et conseils

Nous vous conseillerons volontiers individuellement et sommes à votre disposition si vous avez des questions à poser. Veuillez nous envoyer votre requête à: info@jansen.com

Jansen Docu Center

The platform for working efficiently with Jansen documentation. The latest version of all the product information is available digitally at any time in the Jansen Docu Center – from order and fabrication manuals to architect information, instructions and brochures and videos.

The content can be retrieved quickly and easily. The user can work conveniently without paper, which has numerous benefits.

Download CAD files

DXF

DWG

You can download the drawings in DXF and/or DWG format. Click on the relevant icon to begin the download.

The items «Article library/Door fittings/Window fittings» means that you download the entire article library for the corresponding system with one click (profiles, fittings, glazing beads, accessories etc.).

Information and advice

We would be delighted to provide you with advice in person and are available to answer any questions you may have. Please write to us with your queries at: info@jansen.com

Zulassungen/Prüfungen
Homologations/Essais
Authorisations/Tests

Jansen-Economy 60 Türen
Jansen-Economy 60 portes
Jansen-Economy 60 doors

Elementgrößen
(Empfehlung für CE-Kennzeichnung)

Dimensions des éléments
(Recommandation pour le label CE)

Size of elements
(Recommendation for CE marking)

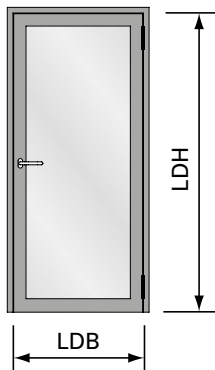

LDB Lichte Durchgangsbreite
max. 1400 mm
min. 490 mm

LDB Largeur vide lumière
max. 1400 mm
min. 490 mm

LDB Clear opening width
max. 1400 mm
min. 490 mm

LDH Lichte Durchgangshöhe
max. 3000 mm
min. 1900 mm

LDH Hauteur vide lumière
max. 3000 mm
min. 1900 mm

LDH Clear opening height
max. 3000 mm
min. 1900 mm

Flügelgewicht max. 230 kg

Poids de vantail max. 230 kg

Weight of leaf max. 230 kg

Zulassungen/Prüfungen
Homologations/Essais
Authorisations/Tests

Jansen-Economy 60 Türen
Jansen-Economy 60 portes
Jansen-Economy 60 doors

Elementgrößen
(Empfehlung für CE-Kennzeichnung)

Dimensions des éléments
(Recommandation pour le label CE)

Size of elements
(Recommendation for CE marking)

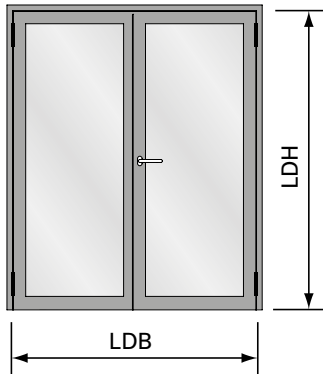

LDB Lichte Durchgangsbreite
max. 2800 mm
min. 1000 mm

LDB Largeur vide lumière
max. 2800 mm
min. 1200 mm

LDB Clear opening width
max. 2800 mm
min. 1000 mm

LDH Lichte Durchgangshöhe
max. 3000 mm
min. 1900 mm

LDH Hauteur vide lumière
max. 3000 mm
min. 1900 mm

LDH Clear opening height
max. 3000 mm
min. 1900 mm

Flügelgewicht max. 230 kg

Poids de vantail max. 230 kg

Weight of leaf max. 230 kg

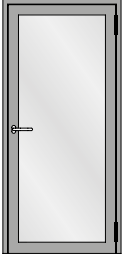

Einflügelige Türe
Porte à un vantail
Single leaf door

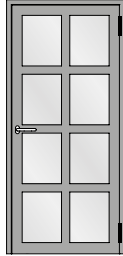

Einflügelige Türe mit Riegel
Porte à un vantail avec traverse
Single leaf door with transom

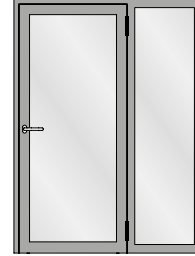

Einflügelige Türe mit Seitenteil
Porte à un vantail avec partie latérale
Single leaf door with side light

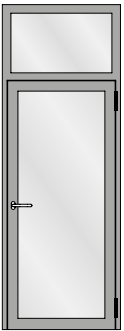

Einflügelige Türe mit Oberlicht
Porte à un vantail avec imposte
Single leaf door with top light

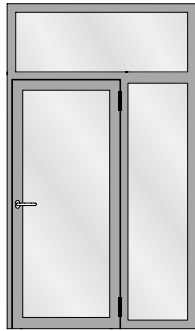

Einflügelige Türe mit Seitenteil und Oberlicht
Porte à un vantail avec avec partie latérale
et imposte
Single leaf door with side light and top light

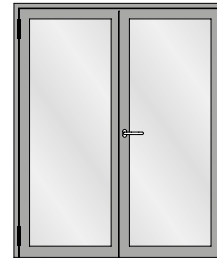

Zweiflügelige Türe
Porte à deux vantaux
Double leaf door

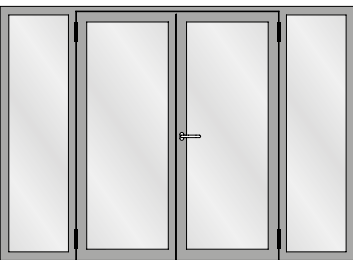

Zweiflügelige Türe mit zwei Seitenteilen
Porte à deux vantaux avec deux parties latérales
Double leaf door with two side lights

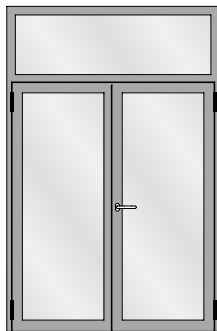

Zweiflügelige Türe mit Oberlicht
Porte à deux vantaux avec imposte
Double leaf door with top light

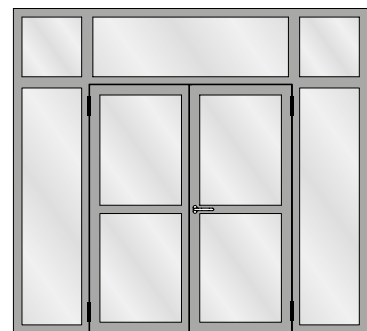

Zweiflügelige Türe mit zwei Seitenteilen und
Oberlichtern
Porte à deux vantaux avec deux parties
latérales et impostes
Double leaf door with two side lights and
top lights

Typenübersicht
Sommaire des types
Summary of types

Jansen-Economy 60 Türen
Jansen-Economy 60 portes
Jansen-Economy 60 doors

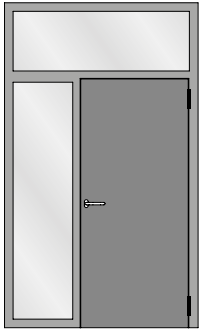

Verblechte Türe mit Seitenteil und Oberlicht
Porte tôlée à un vantail avec avec partie latérale
et imposte
Sheet metal single leaf door with side light
and top light



Verblechte zweiflügelige Türe mit zwei
Seitenteilen und Oberlichtern
Porte tôlée à deux vantaux avec deux parties
latérales et impostes
Sheet metal double leaf door with two side
lights and top lights



Festverglasung
Vitrage fixe
Fixed glazing

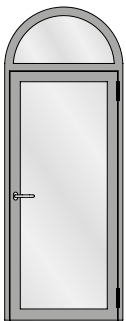

Einflügelige Türe mit Rundbogen-Oberlicht
Porte à un vantail avec imposte demi-ronde
Single leaf door with round arched top light

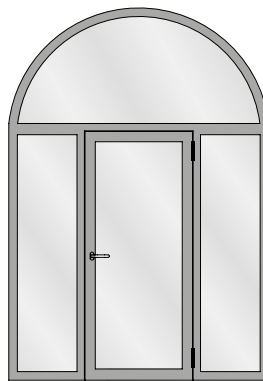

Einflügelige Türe mit zwei Seitenteilen und
Rundbogen-Oberlicht
Porte à un vantail avec deux parties latérales
et imposte demi-ronde
Single leaf door with two side lights and
round arched top light

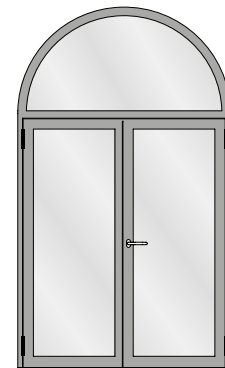

Zweiflügelige Türe mit Rundbogen-Oberlicht
Porte à deux vantaux avec imposte demi-ronde
Double leaf door with round arched top light

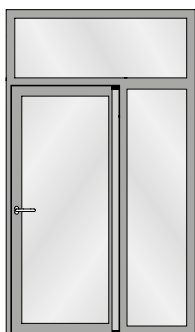

Fingerschutztüre
Porte anti-pince-doigts
Anti-finger-trap door

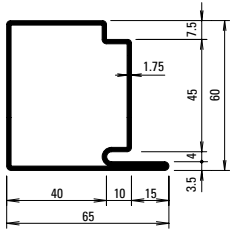

30.019
30.019 Z

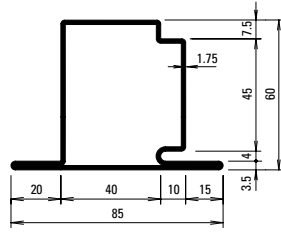

30.119
30.119 Z

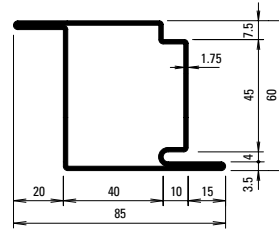

30.419
30.419 Z

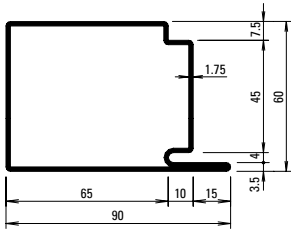

30.017
30.017 Z

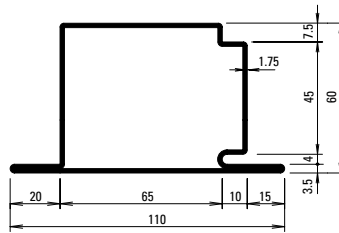

30.117
30.117 Z

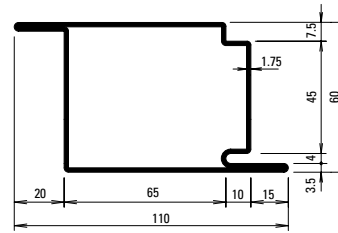

30.415

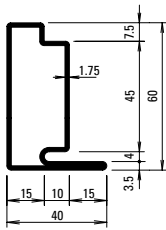

30.018
30.018 Z

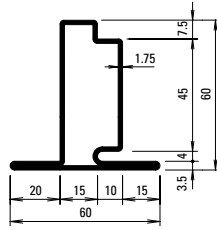

30.118
30.118 Z

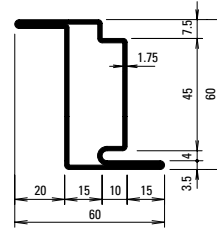

30.418
30.418 Z

Oberfläche/Werkstoff

Artikel-Nr.

ohne Zusatz = blank

mit Z = bandverzinkter Stahl

Surface/Matériau

No. d'article

sans supplément = brut

avec Z = bande d'acier zinguée

Surface/Material

Part no.

without addition = bright

with Z = strip galvanised steel

Profil-Nr.	G kg/m	F cm ²	I _x cm ⁴	W _x cm ³	I _y cm ⁴	W _y cm ³	U m ² /m
30.017	4,200	5,36	31,32	9,09	48,57	10,35	0,312
30.018	2,830	3,61	15,95	4,35	4,77	1,93	0,212
30.019	3,520	4,48	23,69	6,70	19,75	5,55	0,262
30.117	4,750	6,04	34,75	9,35	65,74	11,51	0,350
30.118	3,370	4,29	18,64	4,65	8,26	2,75	0,250
30.119	4,050	5,16	26,80	6,99	29,12	6,58	0,300

Profil-Nr.	G kg/m	F cm ²	I _x cm ⁴	W _x cm ³	I _y cm ⁴	W _y cm ³	U m ² /m
30.415	4,750	6,04	37,79	12,28	65,74	11,51	0,350
30.418	3,370	4,29	22,92	7,37	8,62	2,75	0,250
30.419	4,050	5,16	30,36	9,82	29,12	6,58	0,300

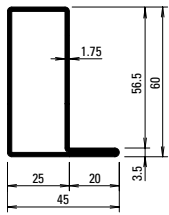

01.634
01.634 Z

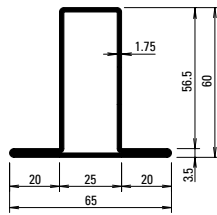

02.634
02.634 Z

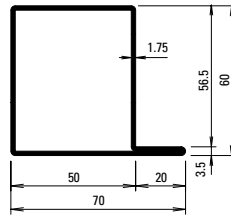

01.684
01.684 Z

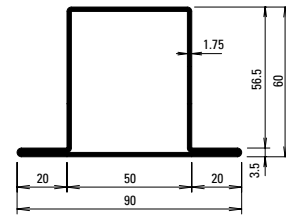

02.684
02.684 Z

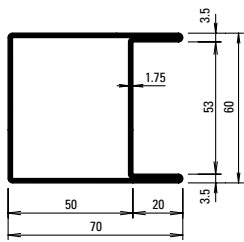

04.637
04.637 Z

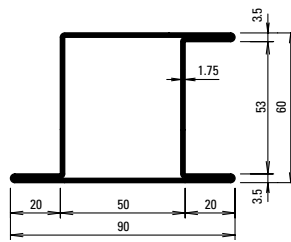

05.637
05.637 Z

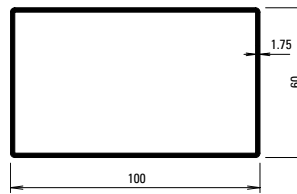

400.051
400.051 Z

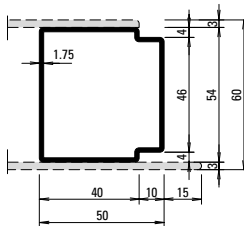

81.010 Z

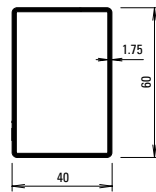

400.052
400.052 Z

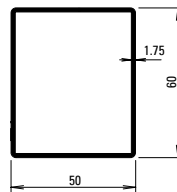

400.054
400.054 Z

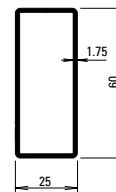

400.055
400.055 Z

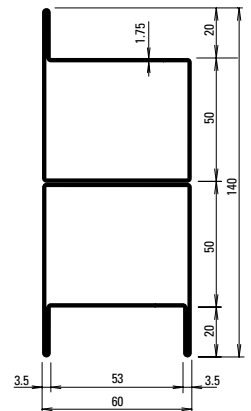

05.001

Profil-Nr.	G kg/m	F cm ²	I _x cm ⁴	W _x cm ³	I _y cm ⁴	W _y cm ³	U m ² /m
01.634	2,730	3,48	16,71	4,71	6,04	2,15	0,204
02.634	3,270	4,17	19,66	5,01	10,34	3,18	0,243
01.684	3,430	4,37	24,34	7,07	22,12	5,59	0,255
02.684	3,960	5,05	27,70	7,36	31,93	7,09	0,294
04.637	3,960	5,05	30,62	10,2	27,45	7,71	0,294
05.637	4,500	5,72	35,42	10,6	39,45	8,02	0,333
81.010	2,700	3,43	14,53	5,38	13,05	5,10	0,202
400.051	4,300	5,44	76,01	15,2	34,64	11,55	0,316
400.052	2,630	3,34	8,98	4,49	16,86	5,62	0,197
400.054	2,900	3,69	14,97	5,98	19,83	6,61	0,217
400.055	2,210	2,82	3,08	2,47	12,41	4,13	0,167

Stabachse
Axe de la barre
Bar axis

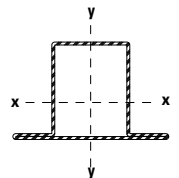

Artikelbibliothek
 Bibliothèque des articles
 Article library

DXF **DWG**

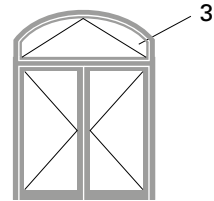
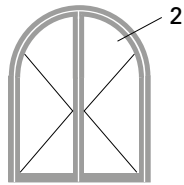
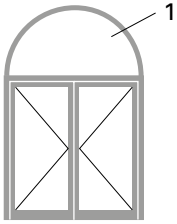

1.0

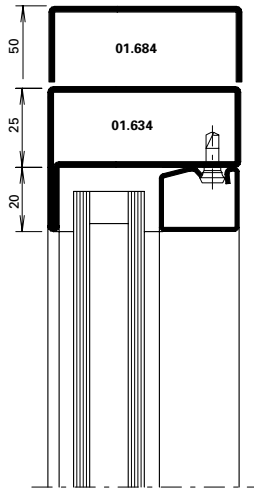

2.0

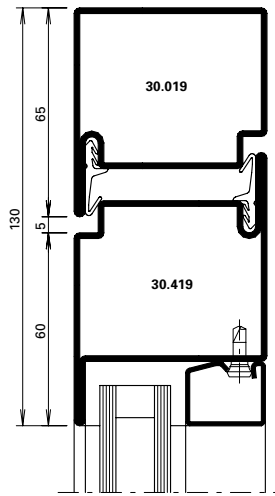

3.0

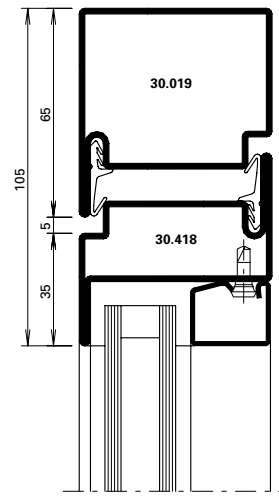

Halbrundbogen
 Arc semi-circulaire
 Semi-circular arch

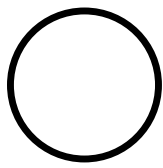

Rundbogen
 Arc en plein centre
 Round arch

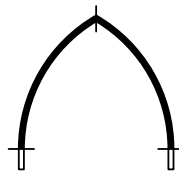

Spitzbogen
 Ogive
 Gothic arch



Stichbogen
 Arc bombé
 Segmented arch



Korbbogen
 Anse de panier
 Oval arch

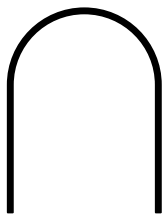

Halbrundbogen mit Schenkel
 Arc surhaussé
 Semi-circular arch with side extension

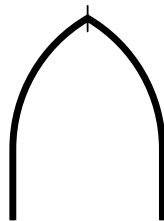

Spitzbogen mit Schenkel
 Arc en ogive
 Gothic arch with side extension

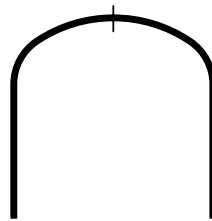



Korbbogen mit Schenkel
 Anse de panier prolongée
 Oval arch with side extension

Bogentüren
Portes cintrées
Arched doors

Jansen-Economy 60 Türen
 Jansen-Economy 60 portes
 Jansen-Economy 60 doors

Profil Profilé Profile	Min. Radius Rayon min. Min. radius R	
------------------------------	---	--

	blank brut bright	verzinkt zinguée galvanised
	mm	mm
01.634	550	550
01.684	650	650

	blank brut bright	verzinkt zinguée galvanised
	mm	mm
02.634	600	650
02.684	1050	1050

	blank brut bright	verzinkt zinguée galvanised
	mm	mm
04.637	1550	1550

	blank brut bright	verzinkt zinguée galvanised
	mm	mm
05.637	1550	1550

	blank brut bright	verzinkt zinguée galvanised
	mm	mm
400.052	1100	1100
400.054	1000	1000
400.055	800	800
81.010		800

Profil Profilé Profile	Min. Radius Rayon min. Min. radius R	
------------------------------	---	--

	blank brut bright	verzinkt zinguée galvanised
	mm	mm
30.018		550
30.019	650	650

	blank brut bright	verzinkt zinguée galvanised
	mm	mm
30.118	800	800
30.119	900	900

	blank brut bright	verzinkt zinguée galvanised
	mm	mm
30.418	800	800
30.419	1100	1100

Stahl-Glasleisten Parcloses en acier Steel glazing beads	Min. Radius Rayon min. Min. radius R
--	---

	
62.507 Z	300 mm
62.508 Z	300 mm
62.509 Z	300 mm

Stahl-Glasleisten Parcloses en acier Steel glazing beads	Min. Radius Rayon min. Min. radius R
--	---

	
402.112 Z	500 mm
402.115 Z	500 mm
402.120 Z	600 mm
402.125 Z	750 mm
402.130 Z	1000 mm
402.135 Z	1500 mm

Aluminium-Glasleisten Parcloses en aluminium Aluminium glazing beads	Min. Radius Rayon min. Min. radius R
--	---

	
404.109	400 mm
404.112	400 mm
404.115	400 mm
404.120	400 mm
404.125	450 mm
404.130	500 mm
404.135	600 mm

	
405.110	500 mm
405.115	500 mm
405.120	500 mm
405.125	800 mm
405.130	1000 mm
406.903	500 mm
406.905	500 mm
406.907	500 mm
406.909	600 mm

Die Radien-Angaben beziehen sich auf die langjährige Erfahrung und Fertigung im Hause Jansen.

Les rayons indiqués se fondent sur la longue expérience et la fabrication au sein de la maison Jansen.

The radii specifications are based on the many years of experience Jansen has in fabrication.

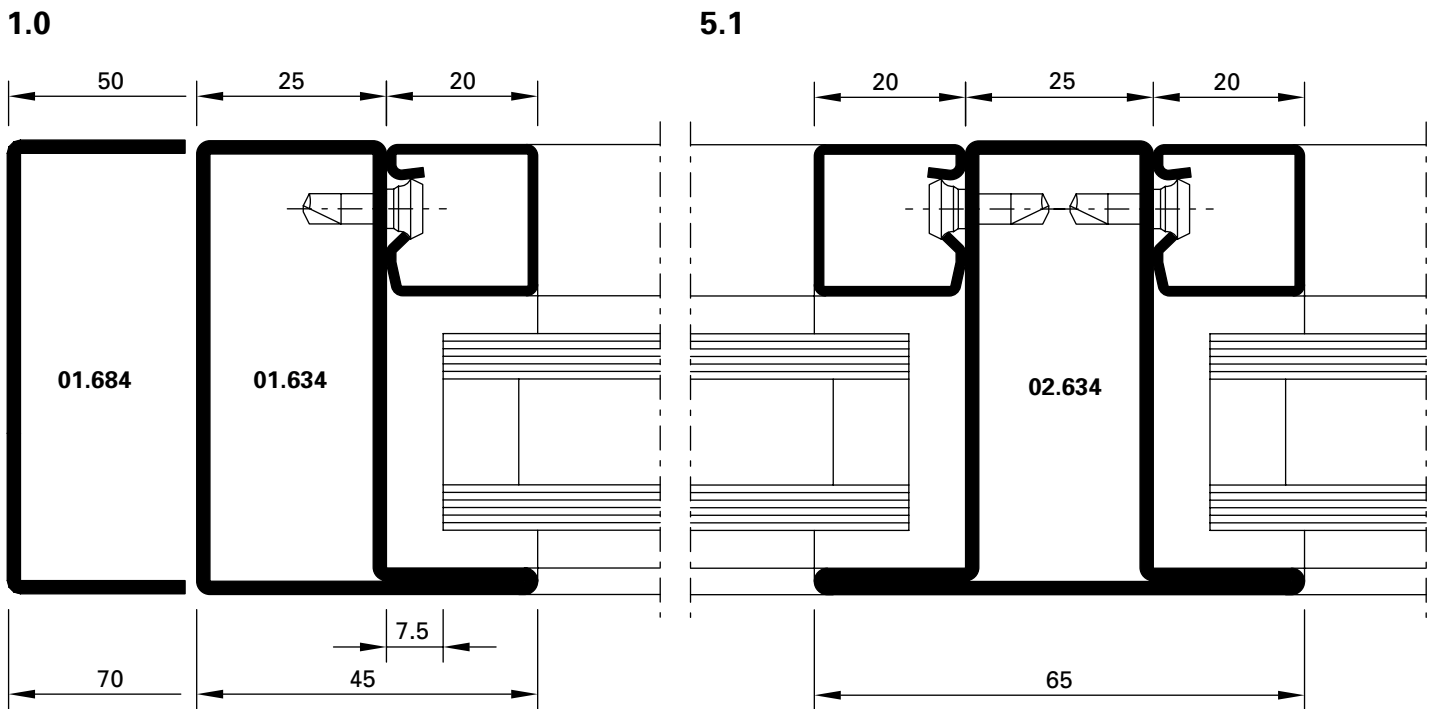
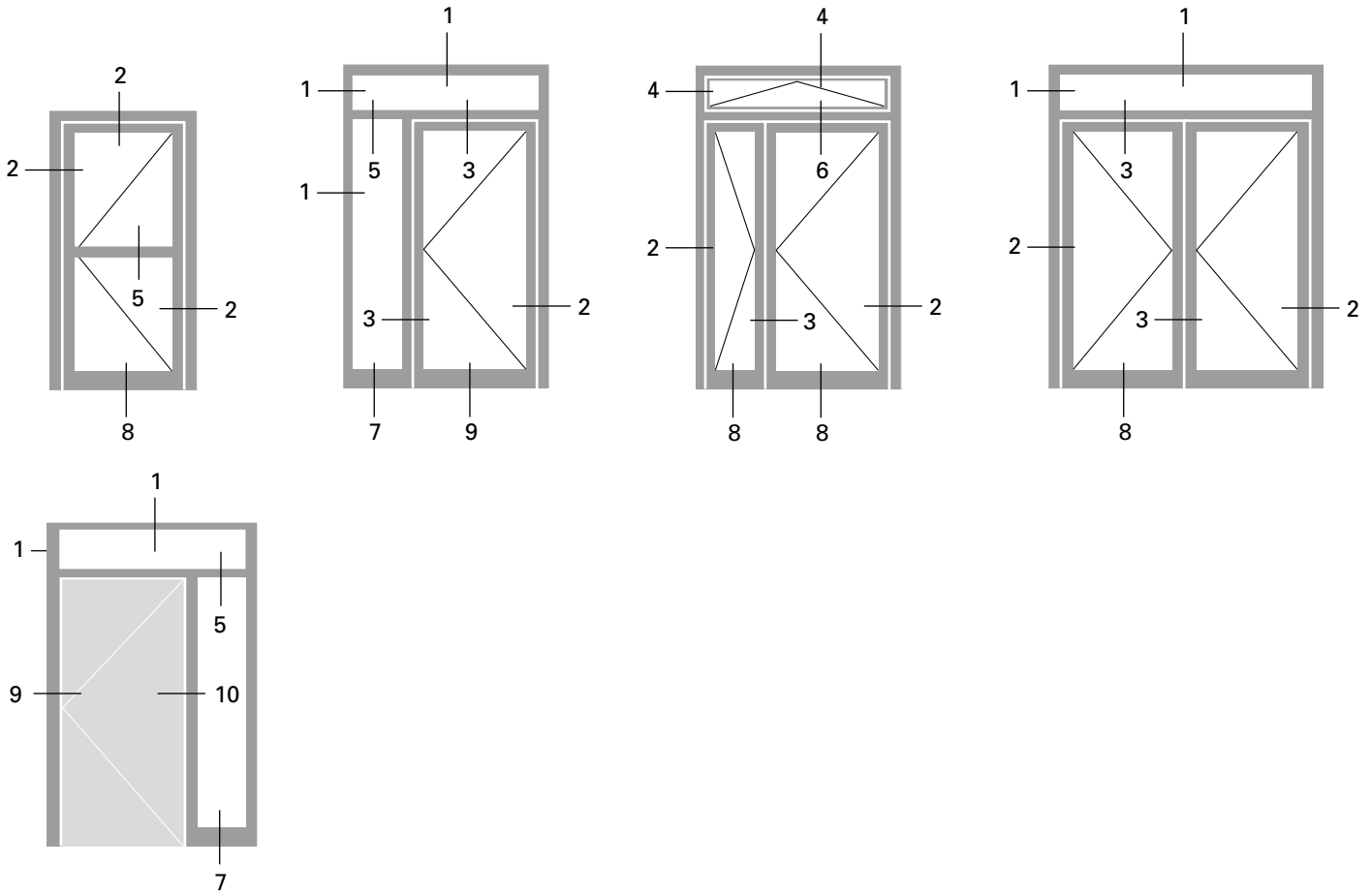

DXF DWG D-250-C-001

DXF DWG D-250-C-032

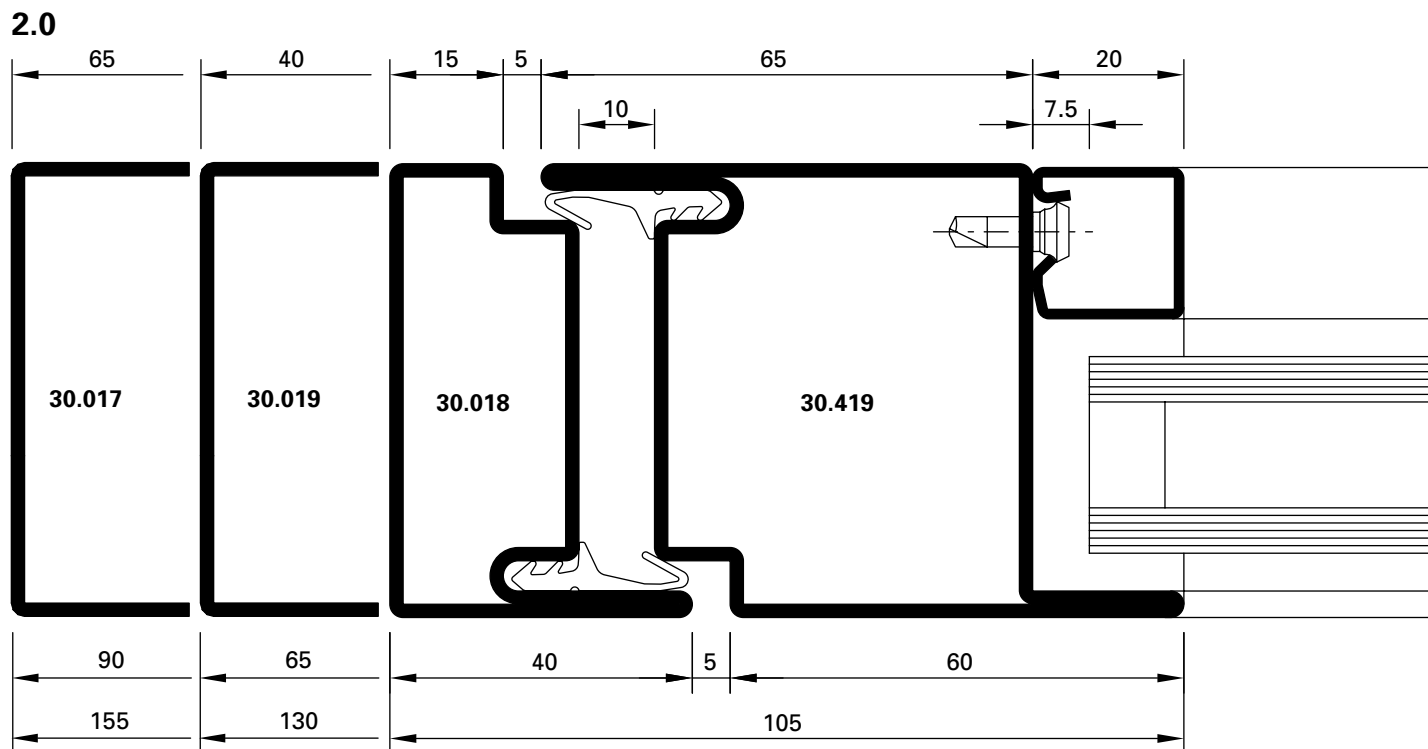

DXF DWG D-250-C-002

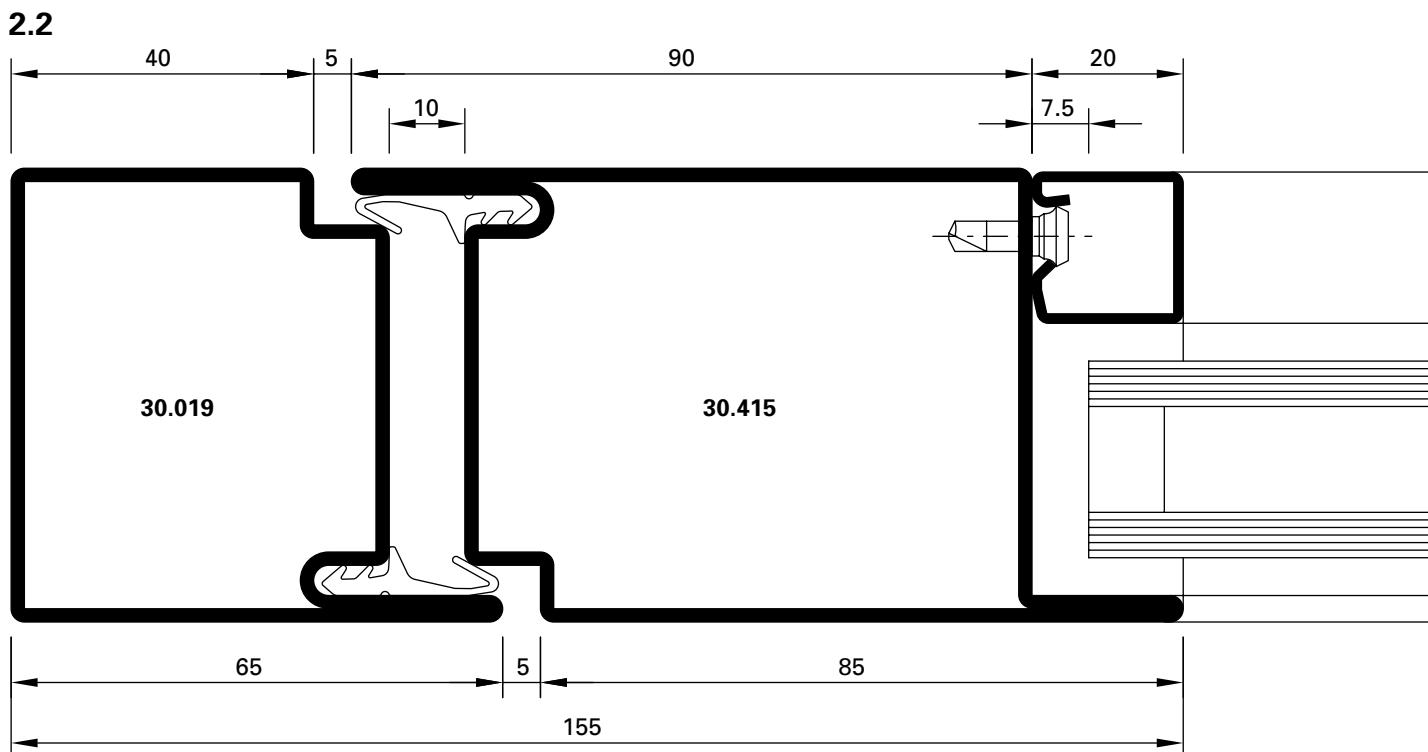

DXF DWG D-250-C-005

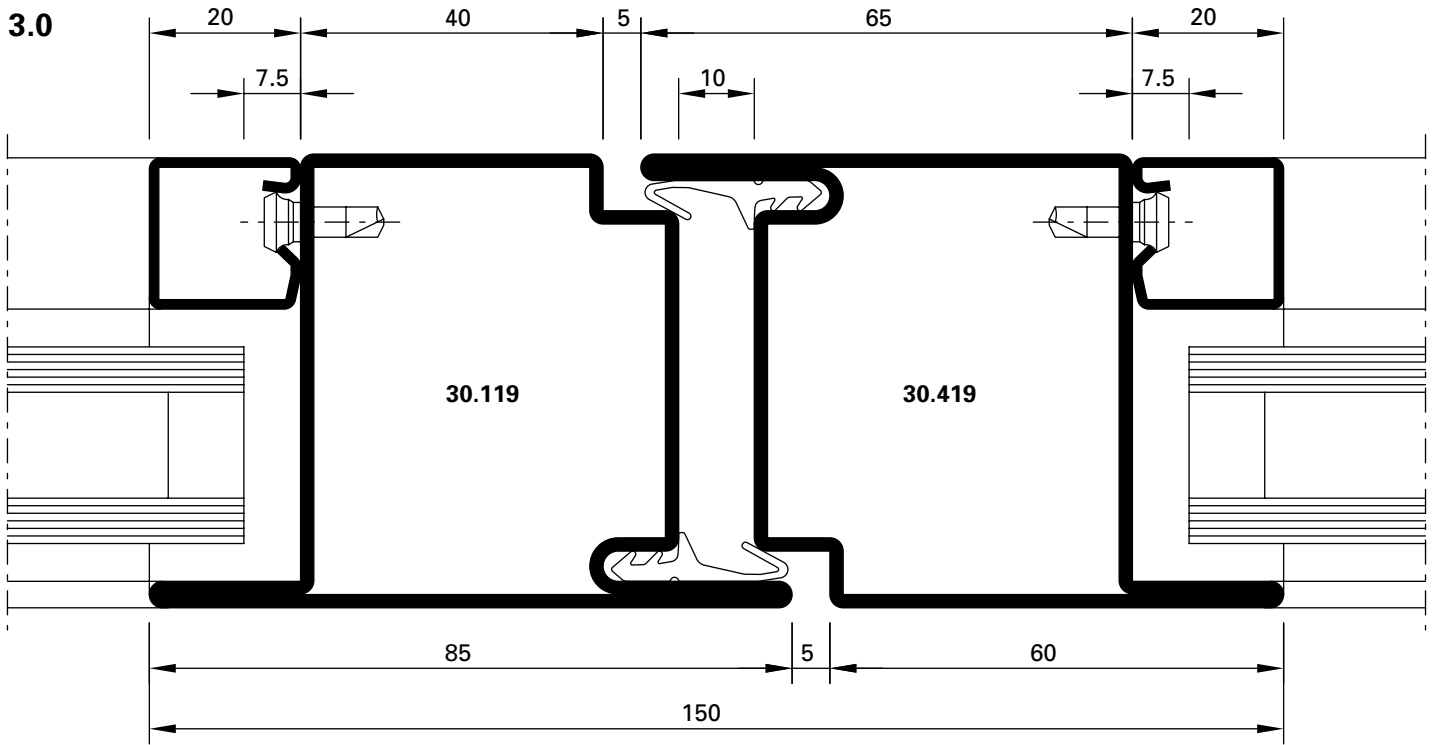

DXF DWG D-250-C-003

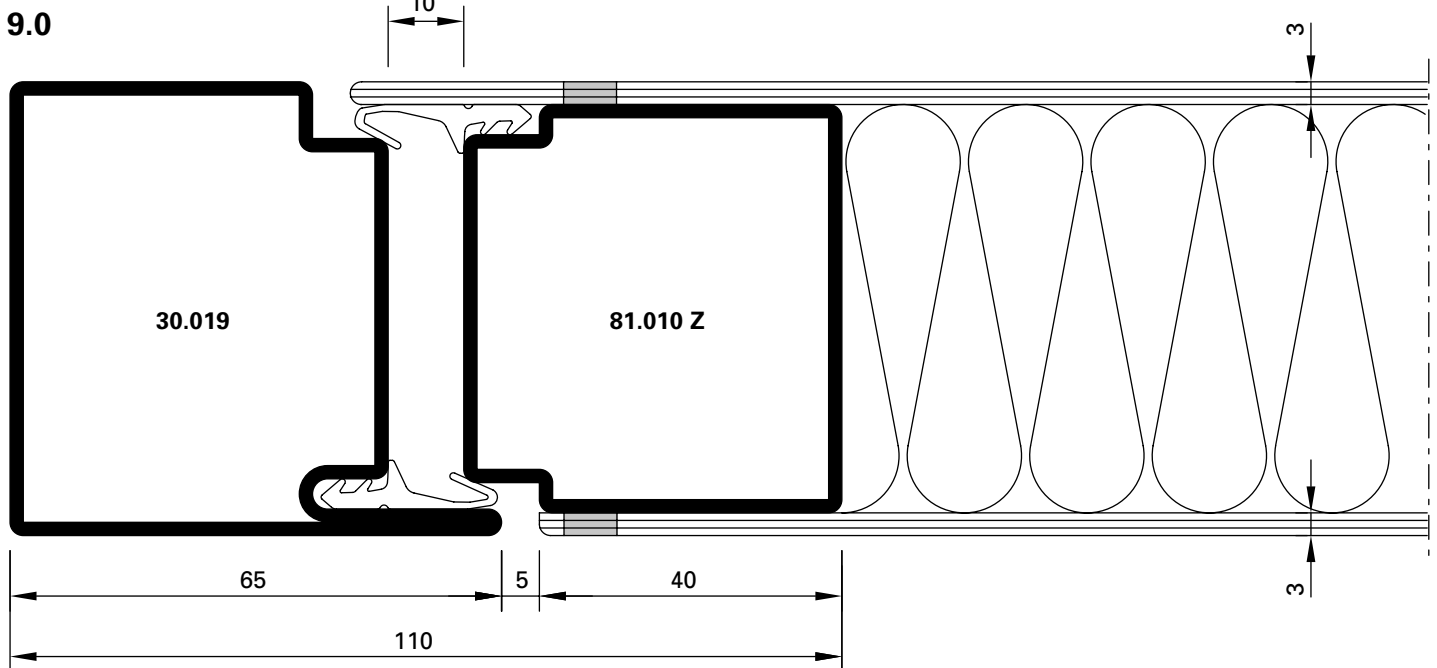

DXF DWG D-250-C-013

4.0

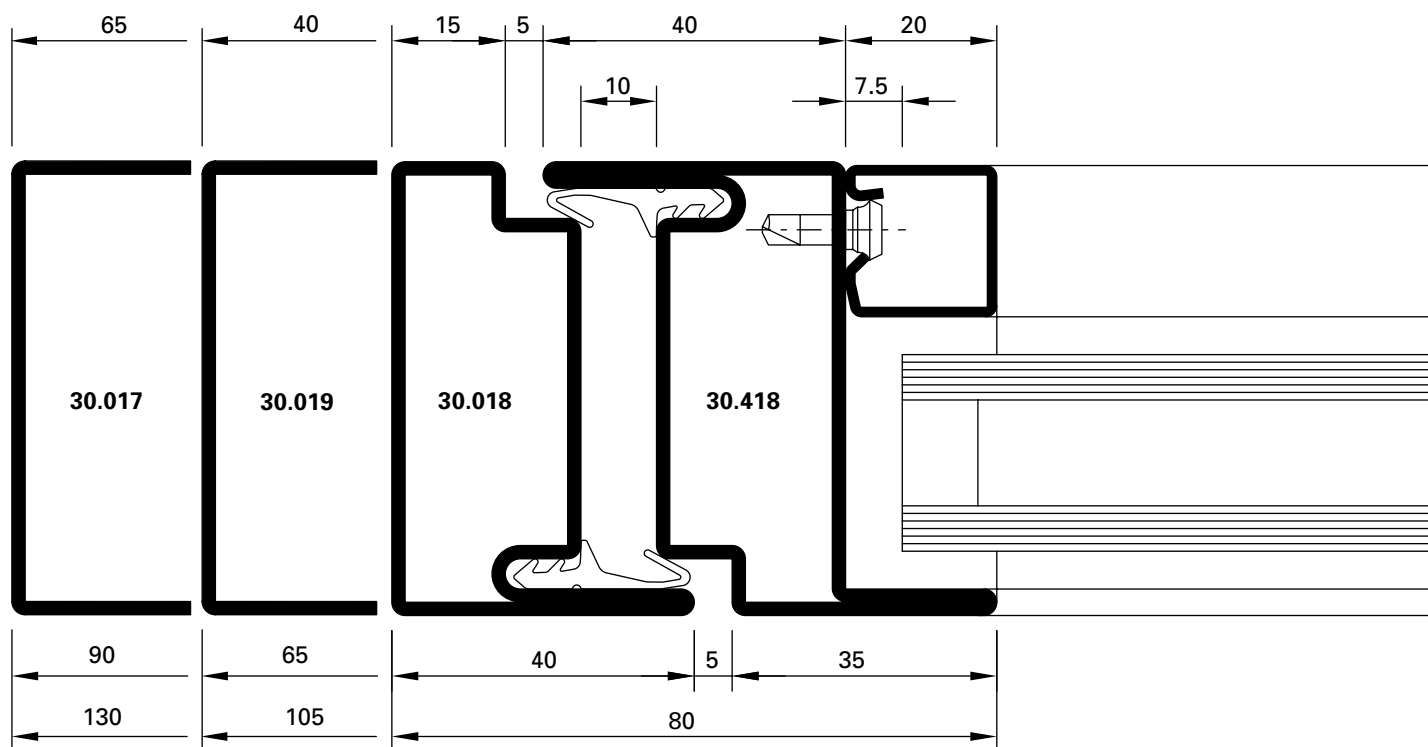

DXF **DWG** D-250-C-010

5.0

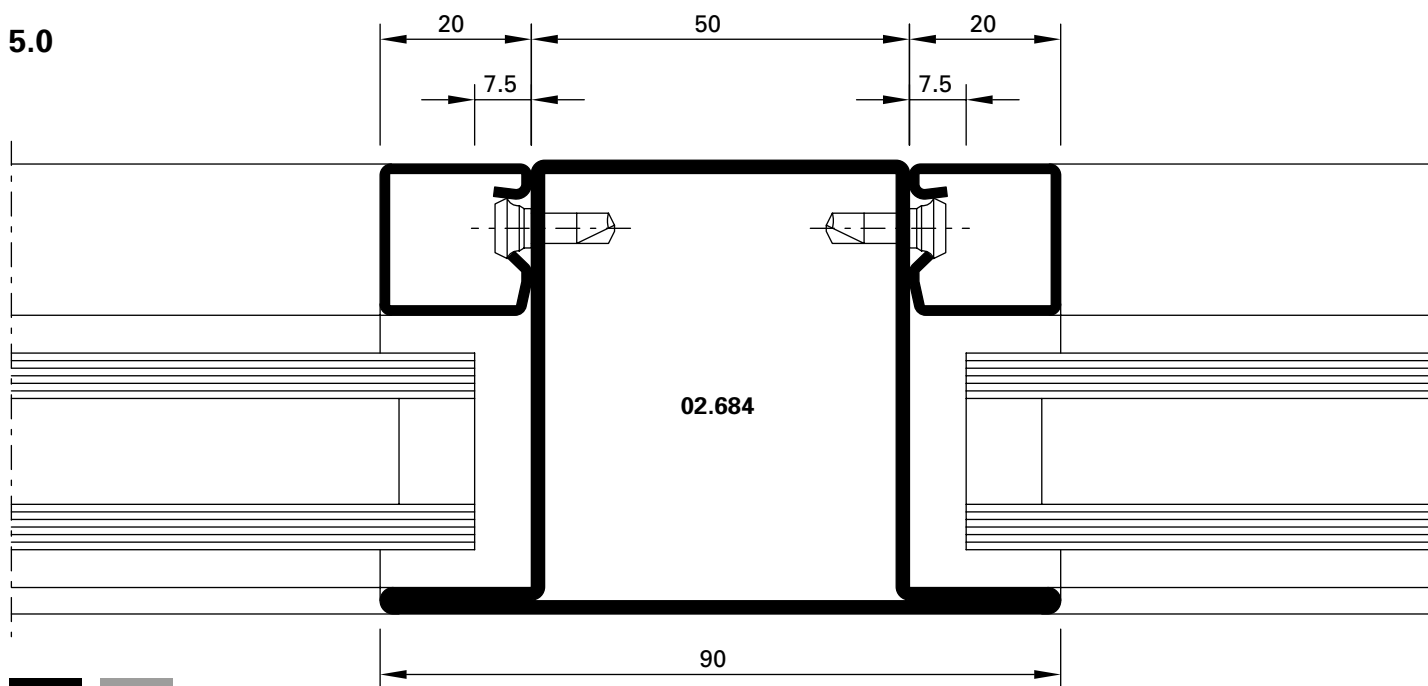

DXF **DWG** D-250-C-012

8.0

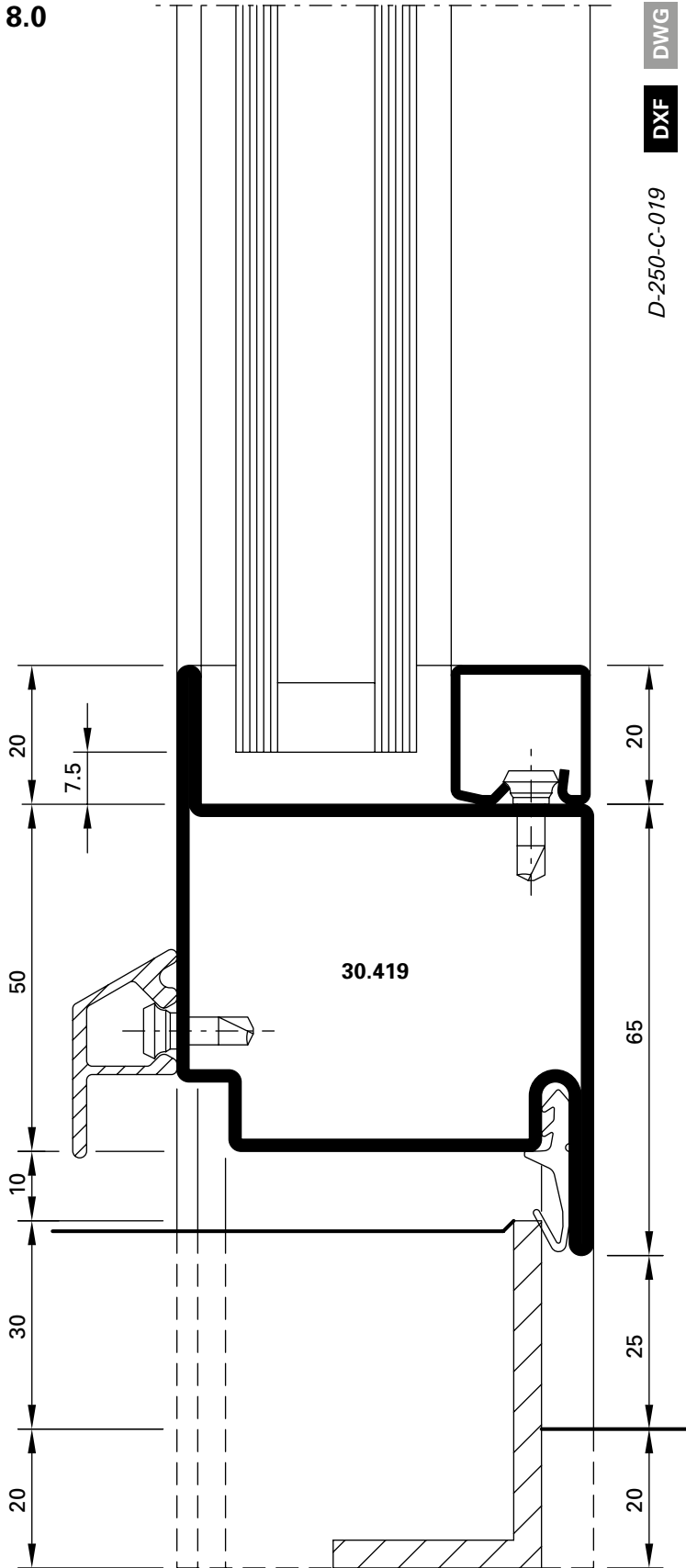

DWG

DXF

D-250-C-019

8.1

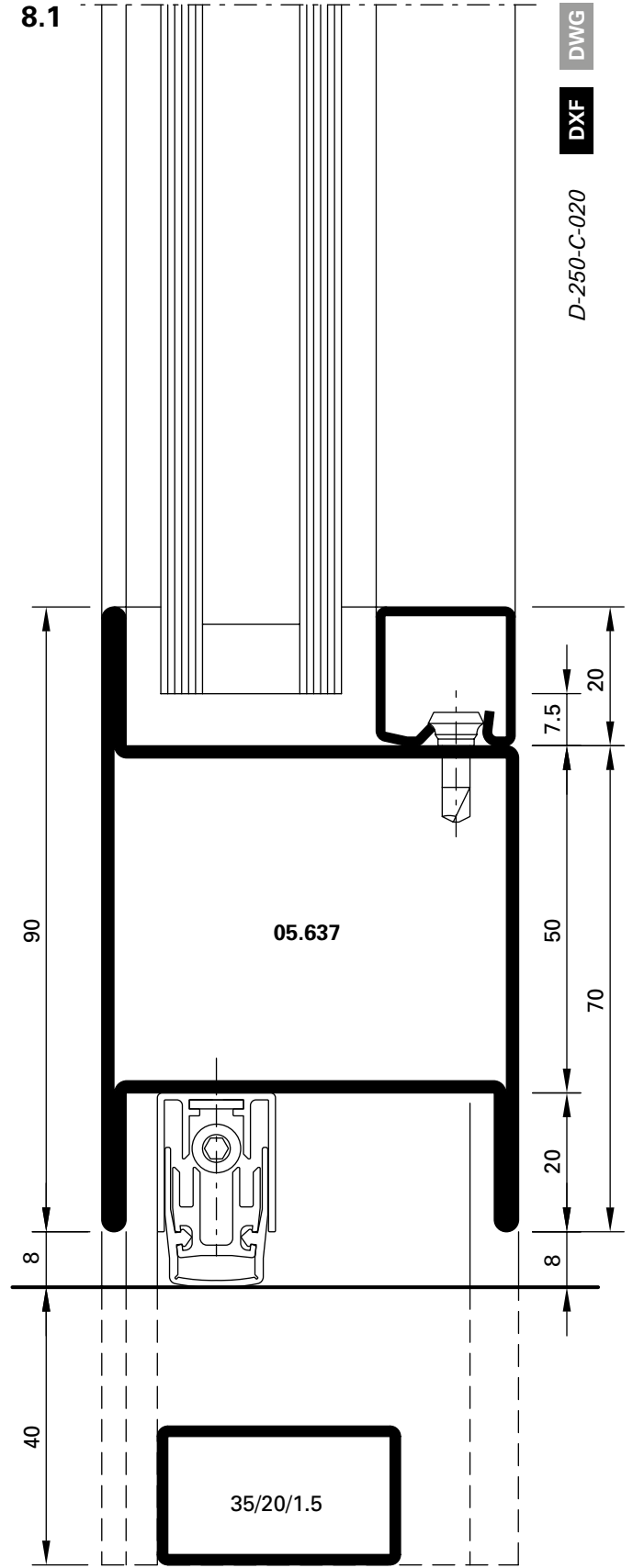

DWG

DXF

D-250-C-020

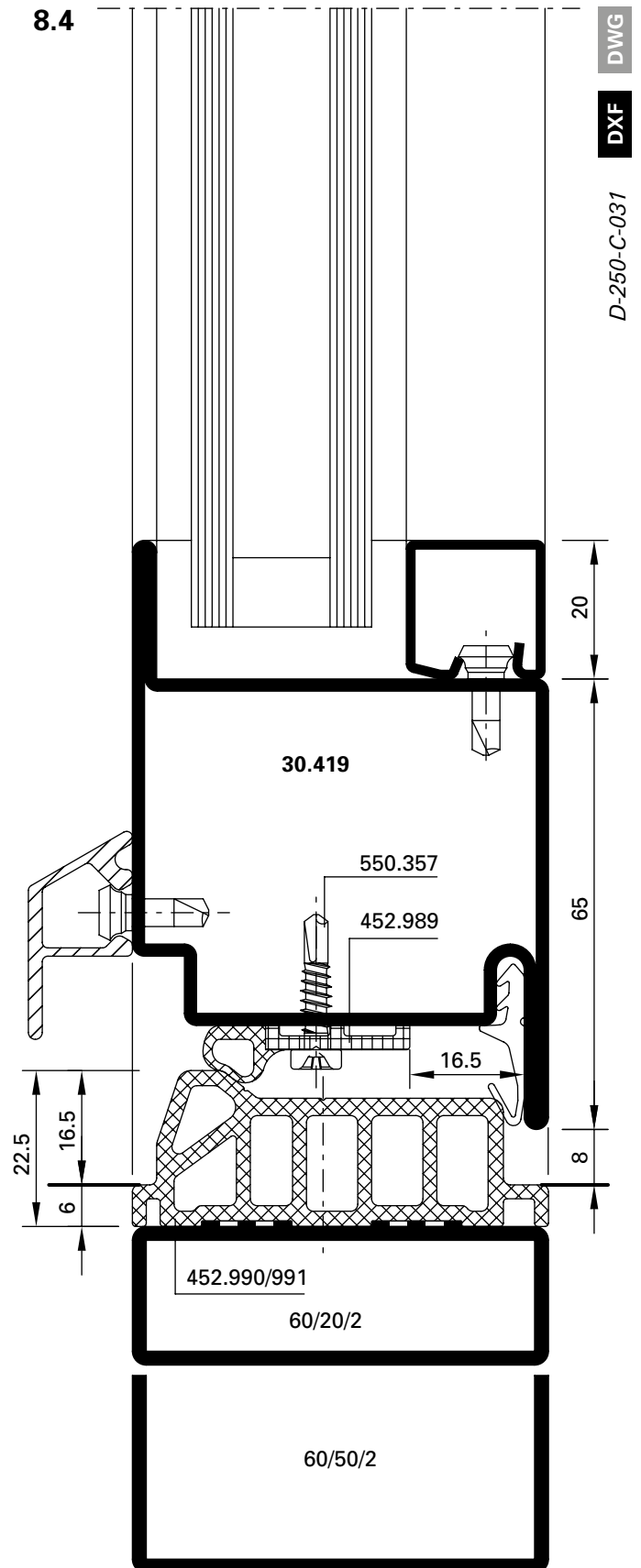
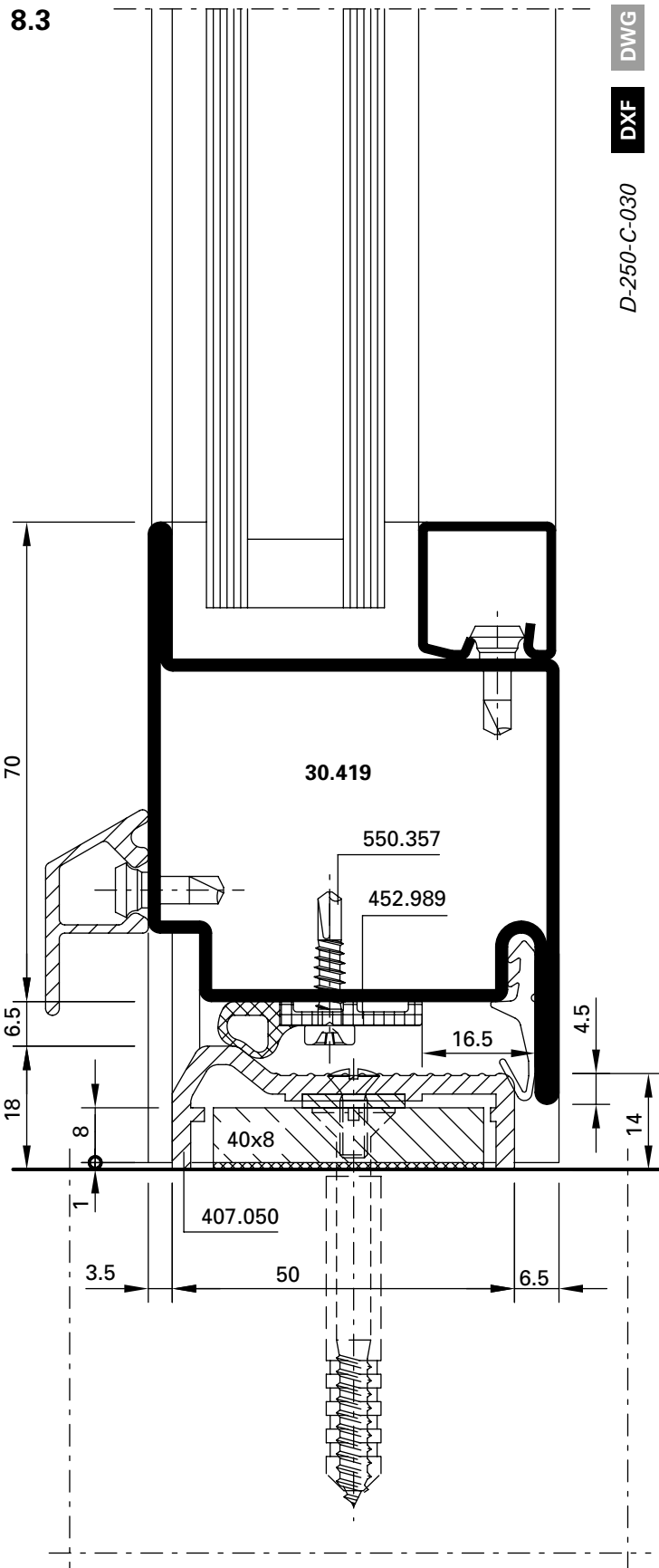

2.1

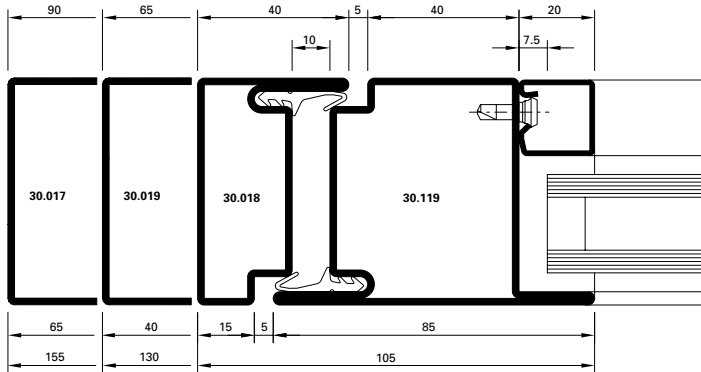

DXF **DWG** *D-250-C-004*

2.3

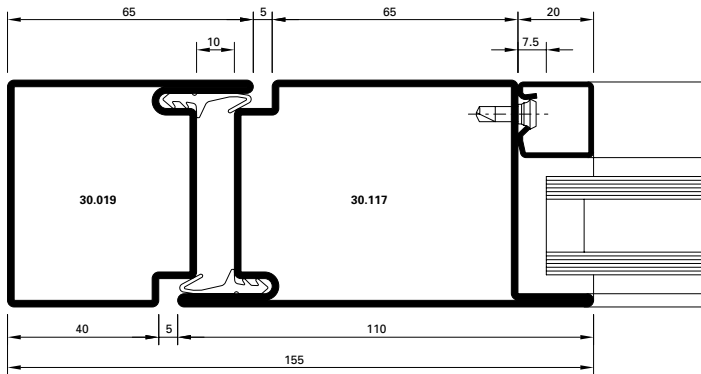

DXF **DWG** *D-250-C-006*

3.1

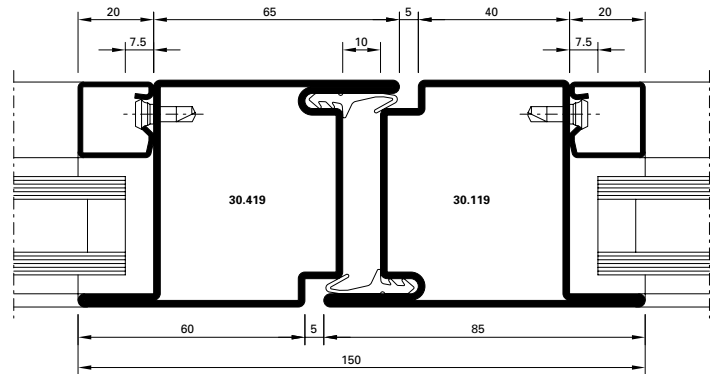

DXF **DWG** *D-250-C-007*

3.2

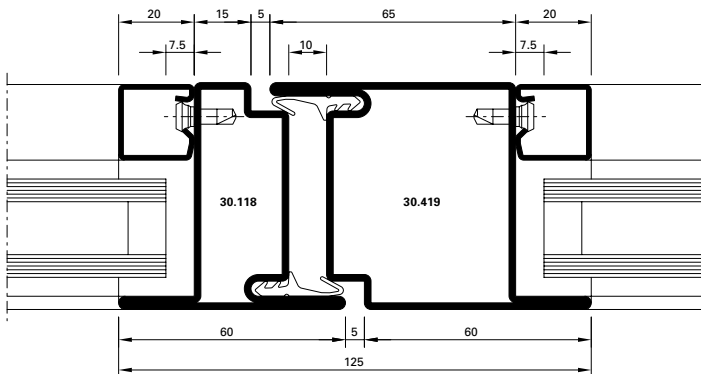

DXF **DWG** *D-250-C-008*

3.3

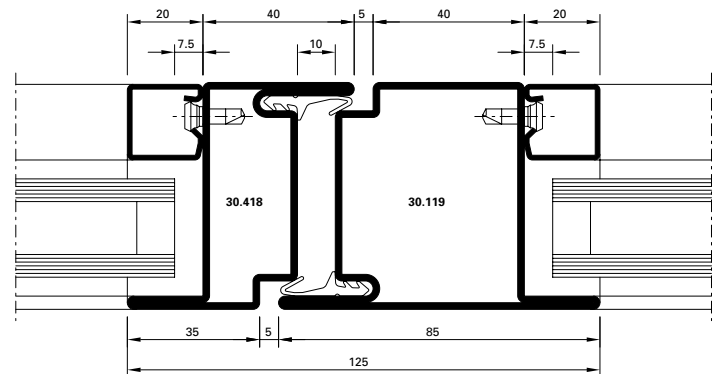

DXF **DWG** *D-250-C-009*

9.1

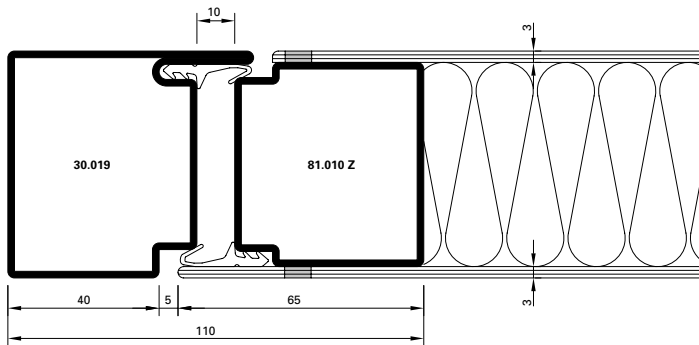

DXF **DWG** D-250-C-014

10.0

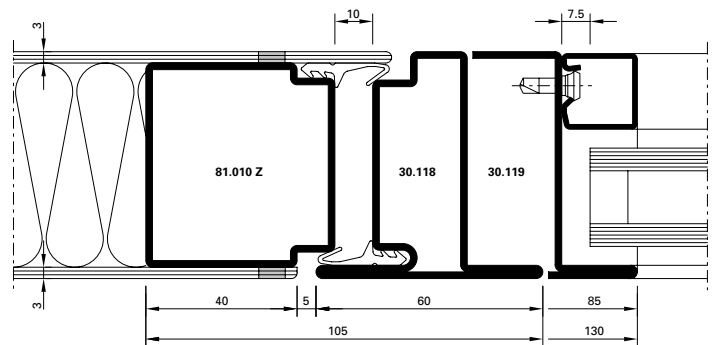

DXF **DWG** D-250-C-015

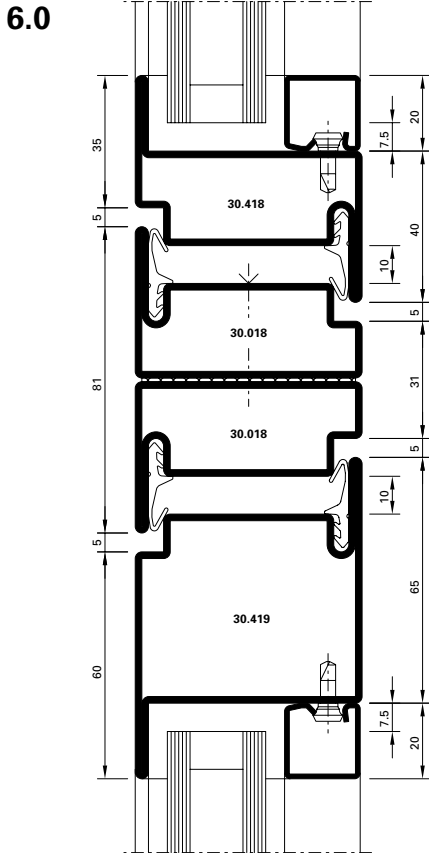

DWG
 DXF
 D-250-C-016

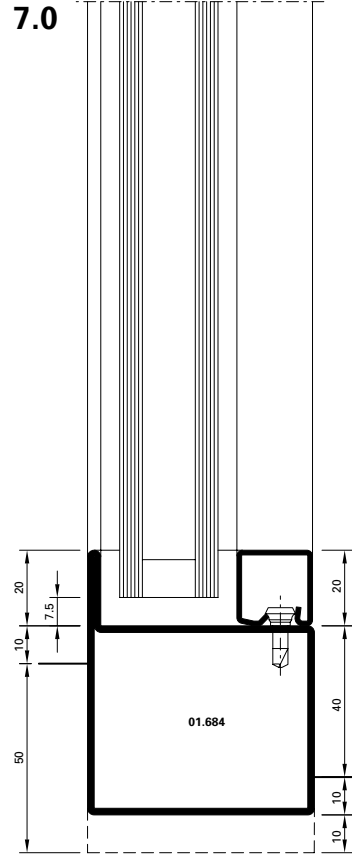

DWG
 DXF
 D-250-C-017

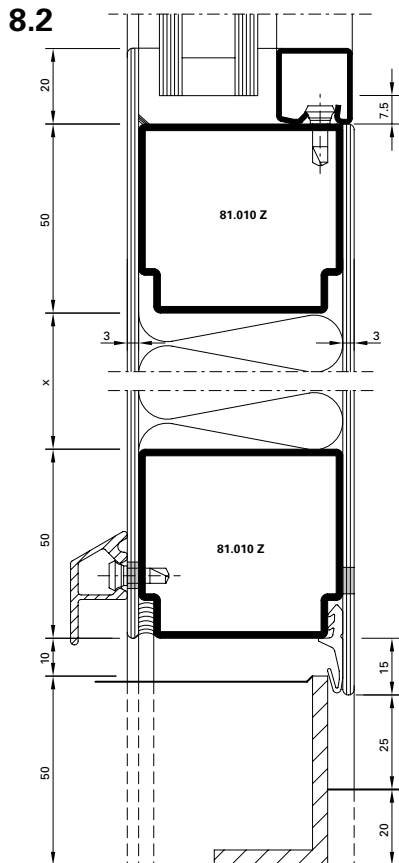

DWG
 DXF
 D-250-C-021

5.1

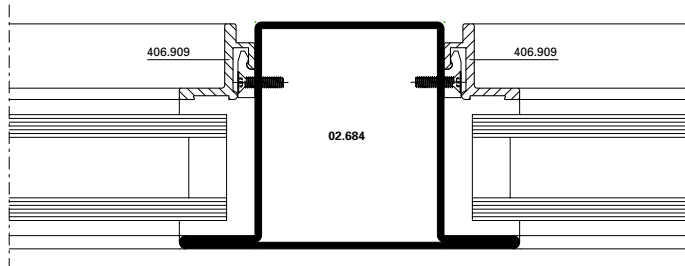

DXF **DWG** *D-250-C-022*

5.2

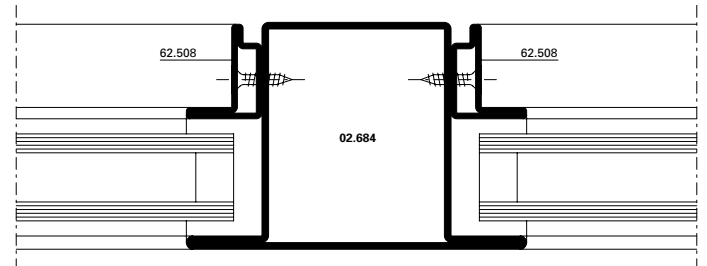

DXF **DWG** *D-250-C-023*

5.3

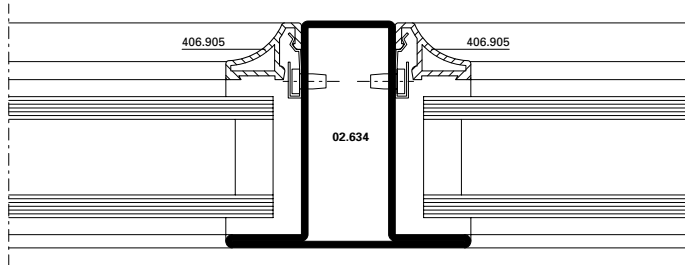

DXF **DWG** *D-250-C-024*

5.4

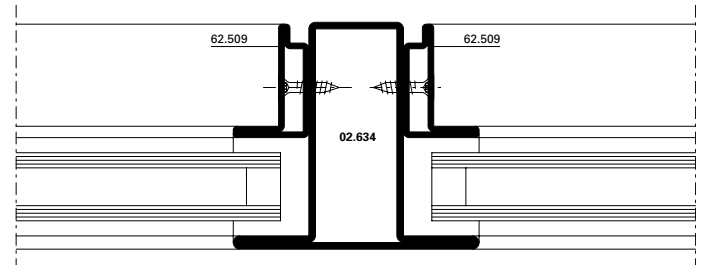

DXF **DWG** *D-250-C-025*

5.5

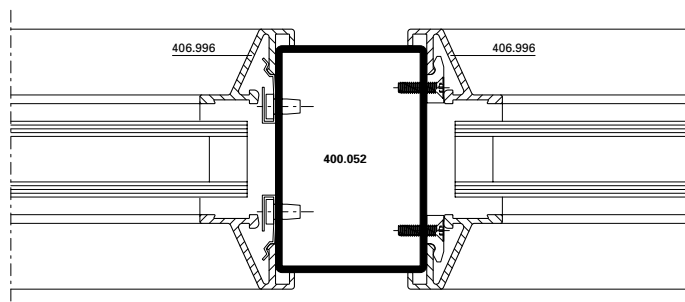

DXF **DWG** *D-250-C-026*

5.6

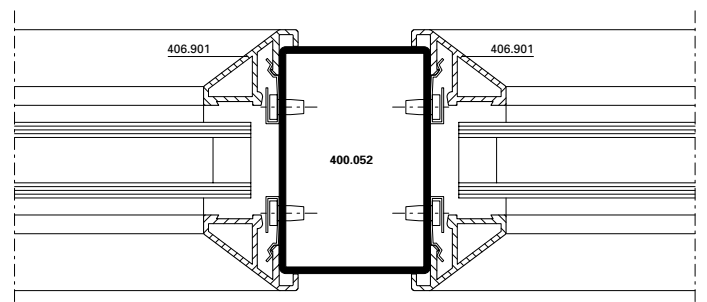

DXF **DWG** *D-250-C-027*

5.7

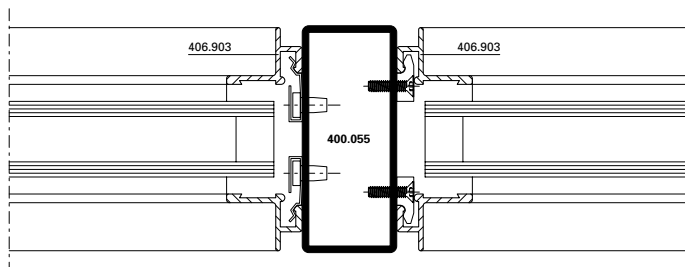

DXF **DWG** *D-250-C-028*

5.8

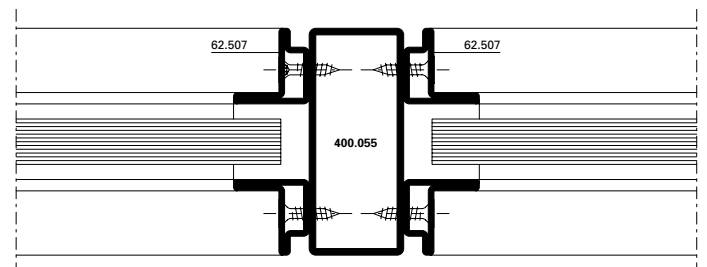

DXF **DWG** *D-250-C-029*

Schnittpunkte im Massstab 1:1
Coupe de détails à l'échelle 1:1
Section details on scale 1:1

Jansen-Economy 60 Türen
Jansen-Economy 60 portes
Jansen-Economy 60 doors

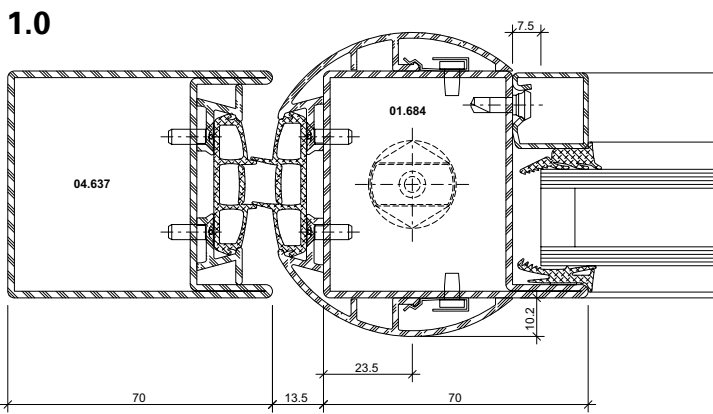
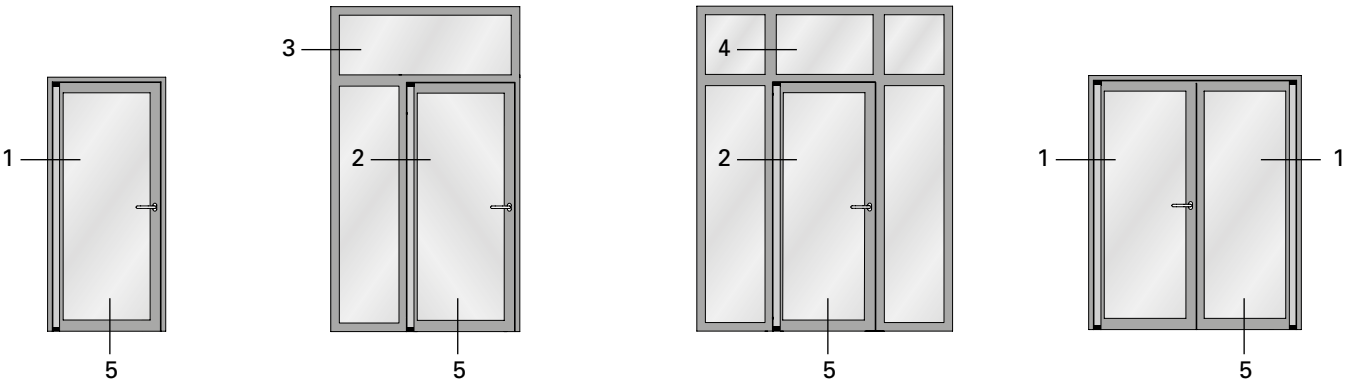

DXF **DWG** 22-0103-C-001

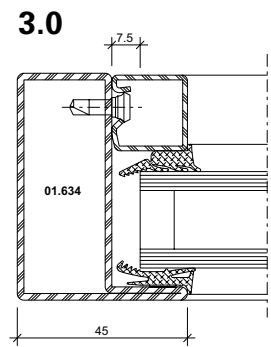

22-0101-C-001
DXF **DWG**

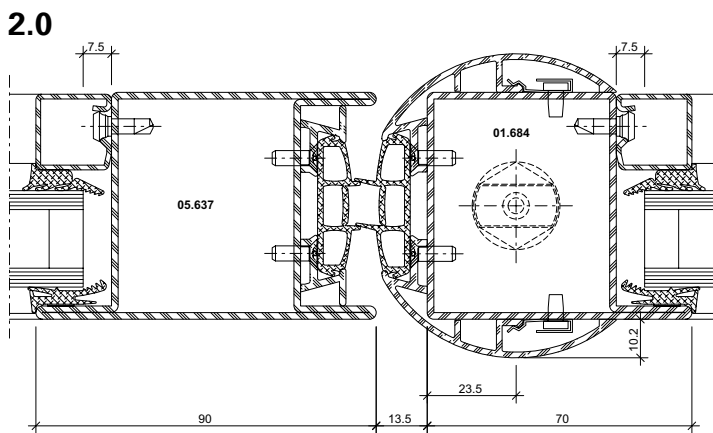

DXF **DWG** 22-0103-C-002

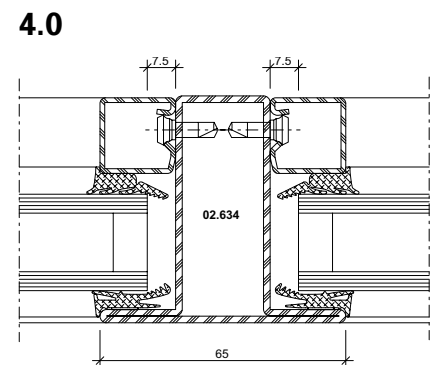

22-0101-C-002
DXF **DWG**

5.0

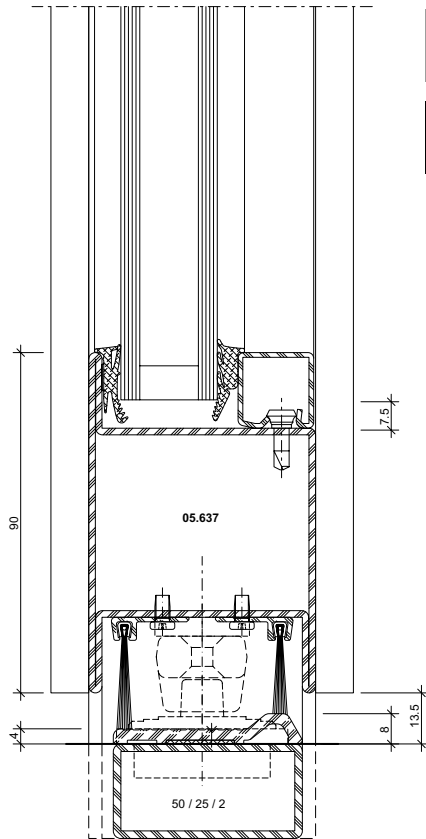

DWG

DXF

22-0103-C-003

5.1

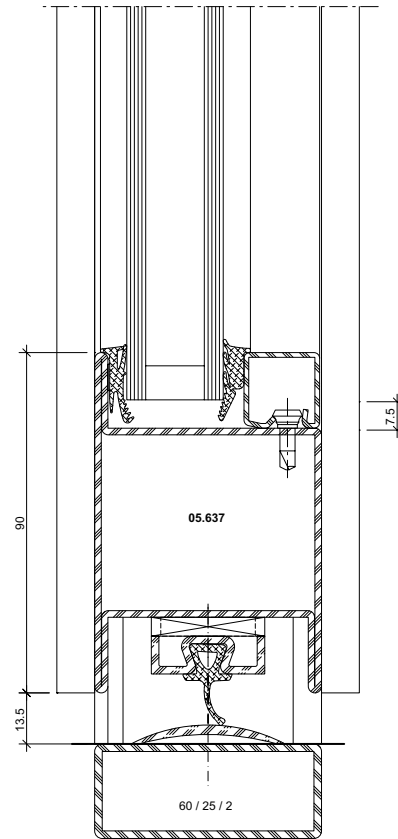

DWG

DXF

22-0103-C-009

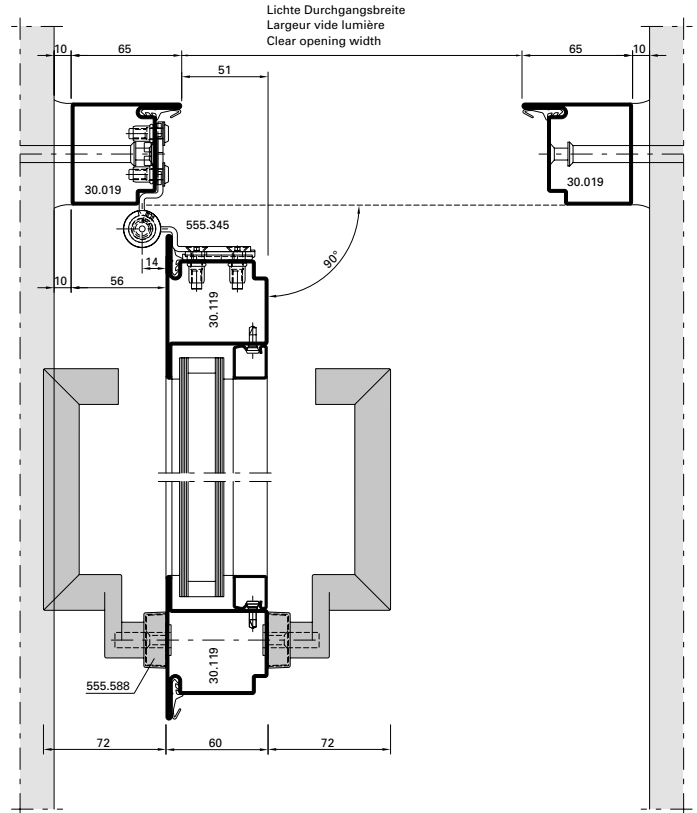
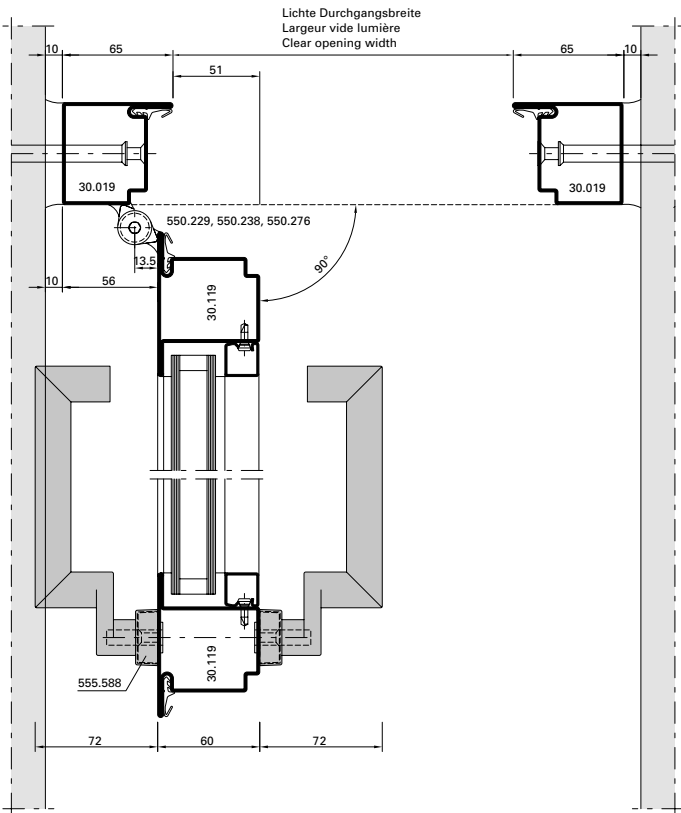

DXF **DWG** *D-250-E-016*

DXF **DWG** *D-250-E-018*

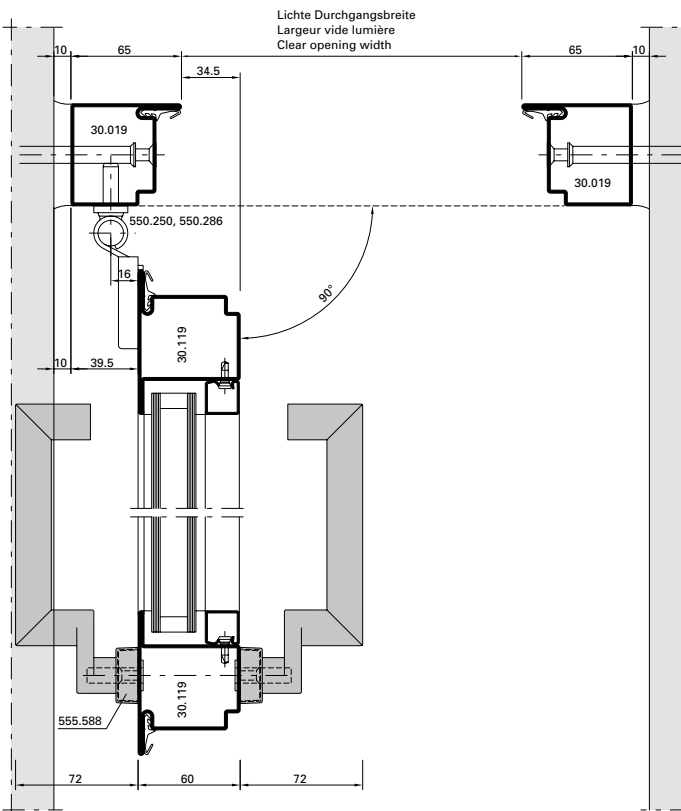

DXF **DWG** *D-250-E-020*

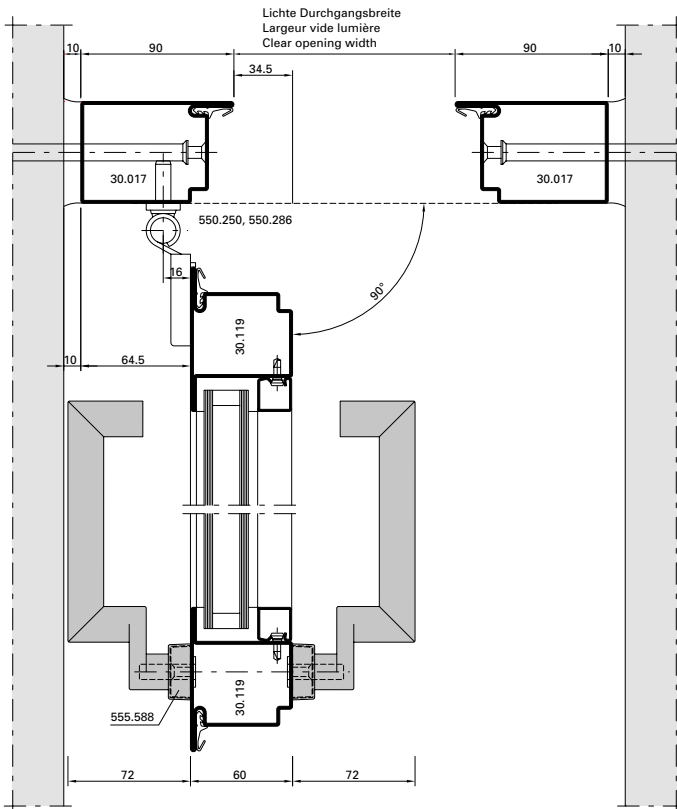

DXF **DWG** *D-250-E-021*

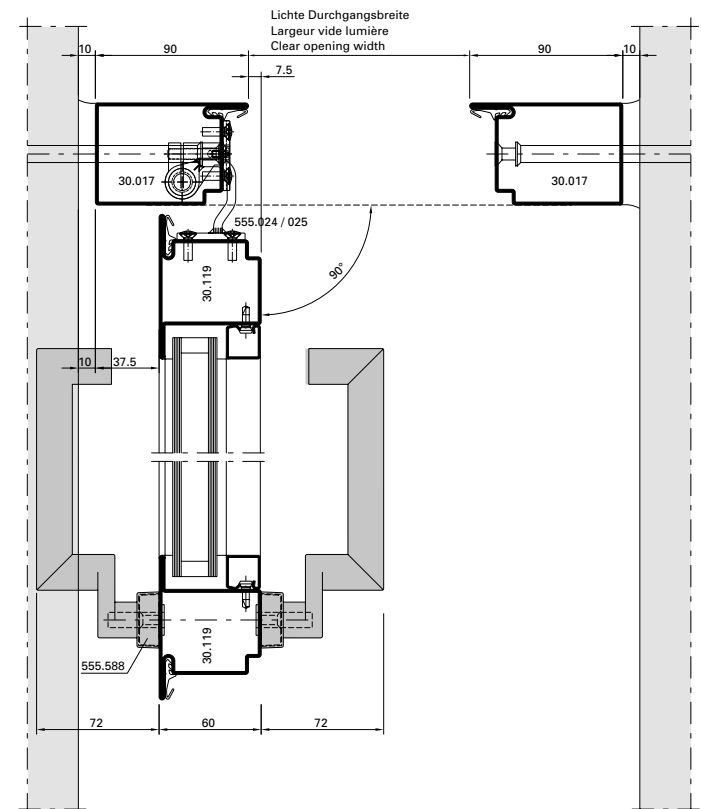

DXF **DWG** *D-250-E-025*

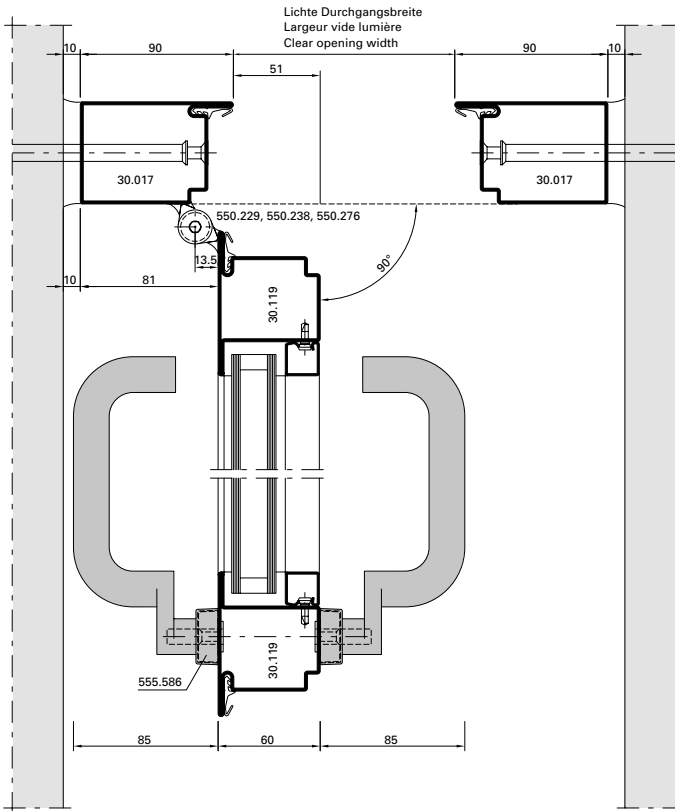

DXF **DWG** *D-250-E-017*

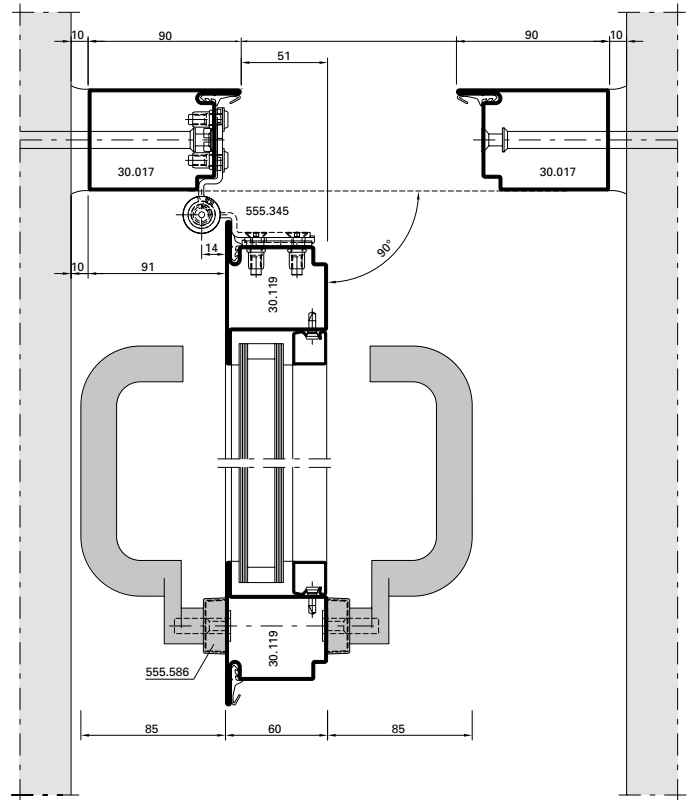

DXF **DWG** *D-250-E-019*

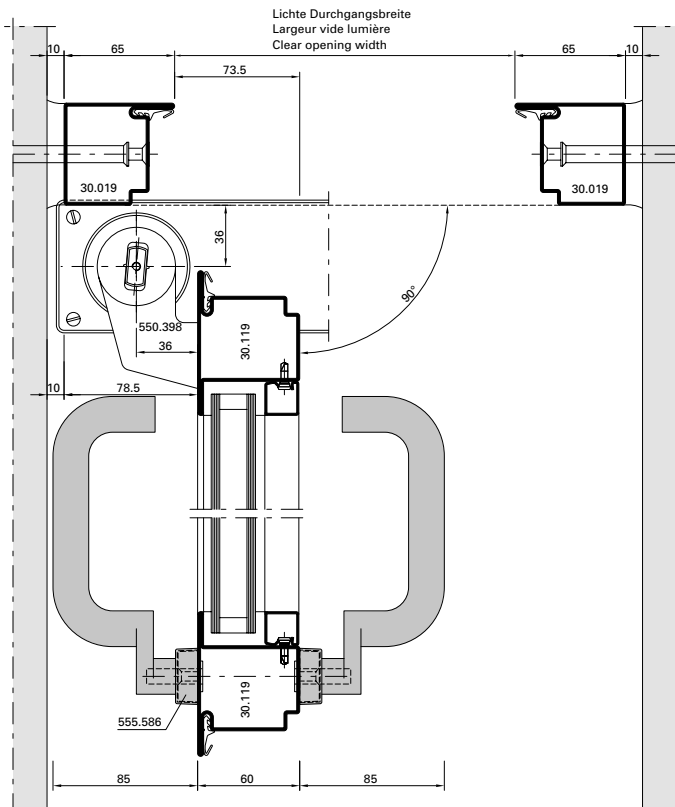

DXF **DWG** *D-250-E-022*

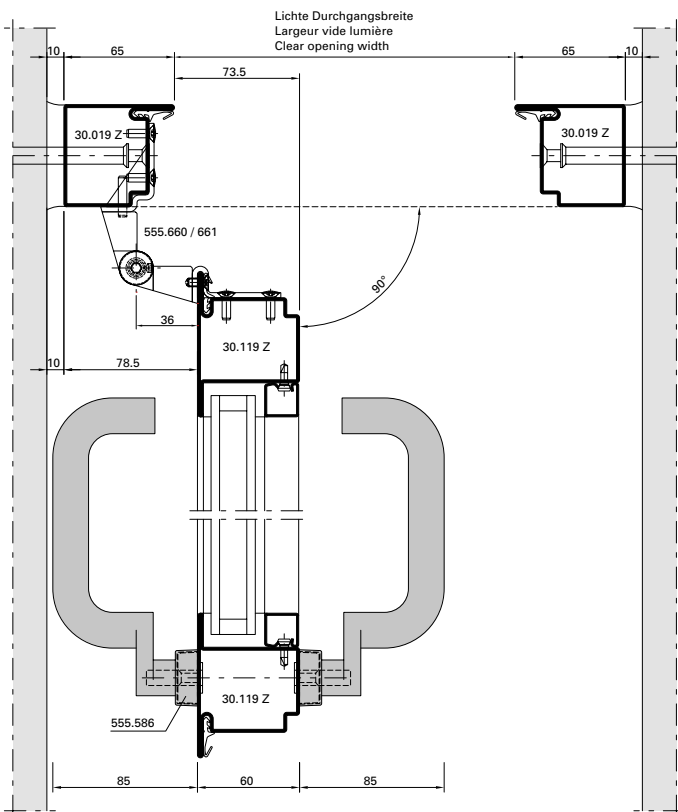

DXF **DWG** *D-250-E-023*

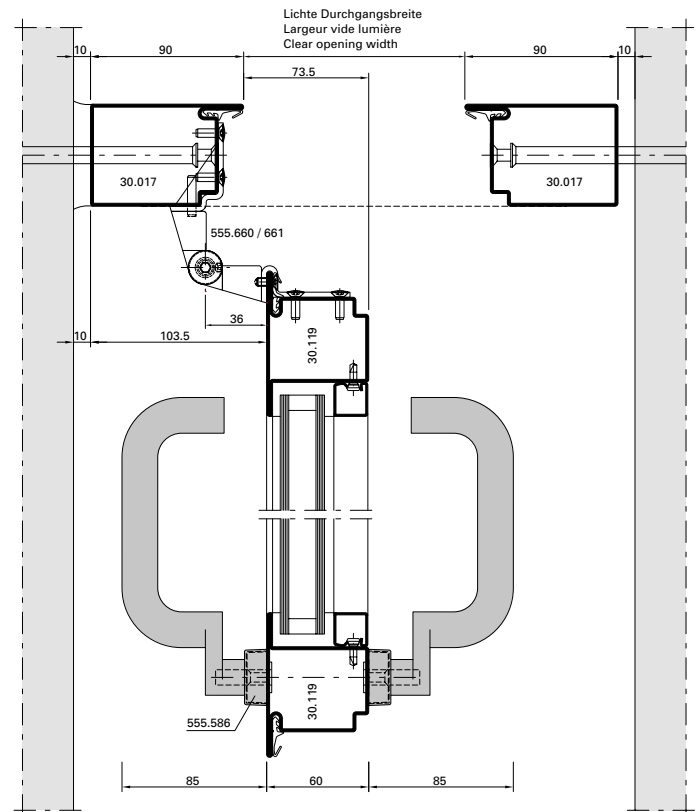

DXF **DWG** *D-250-E-024*

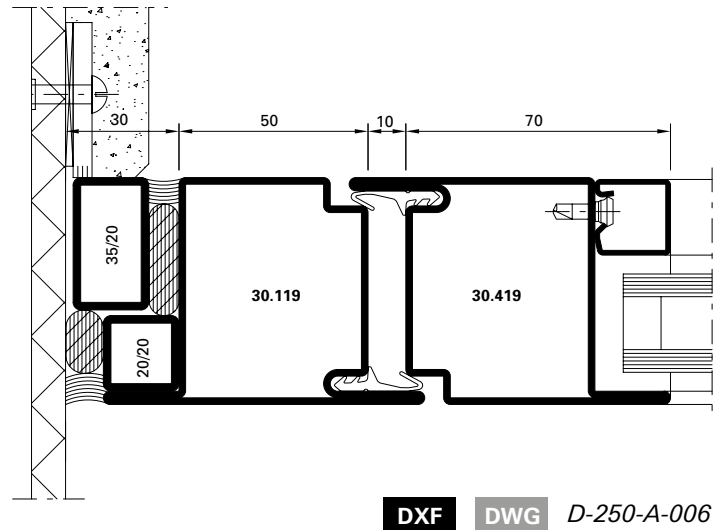
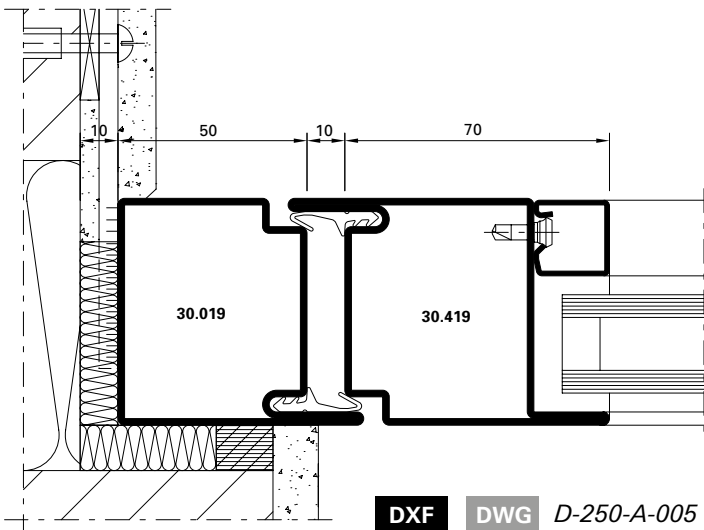
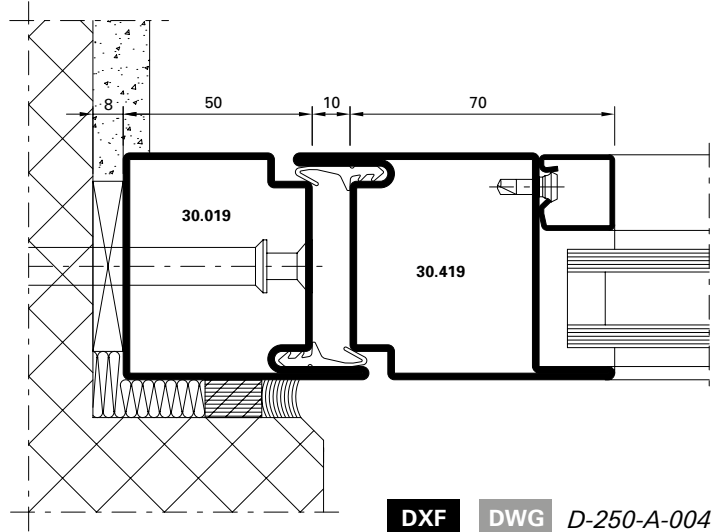
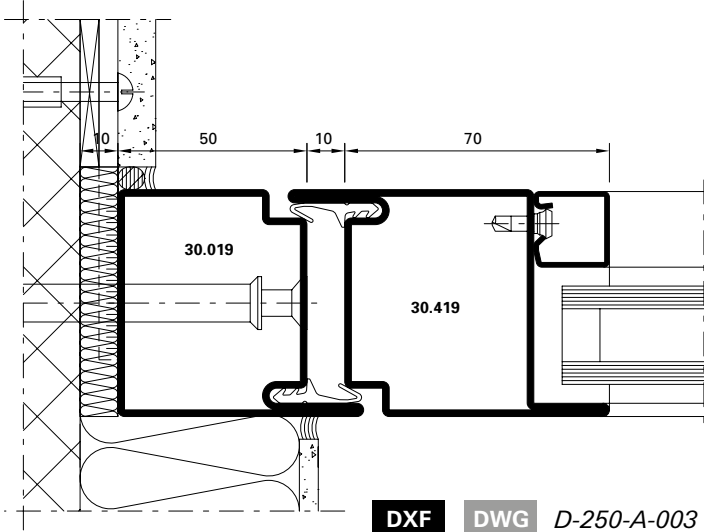
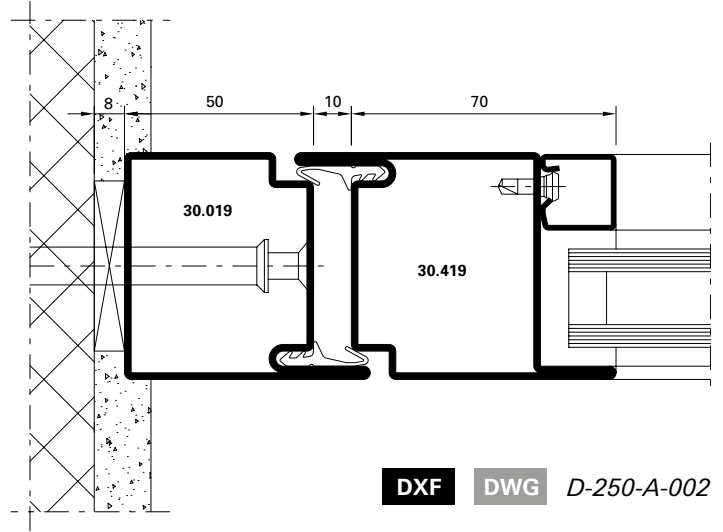
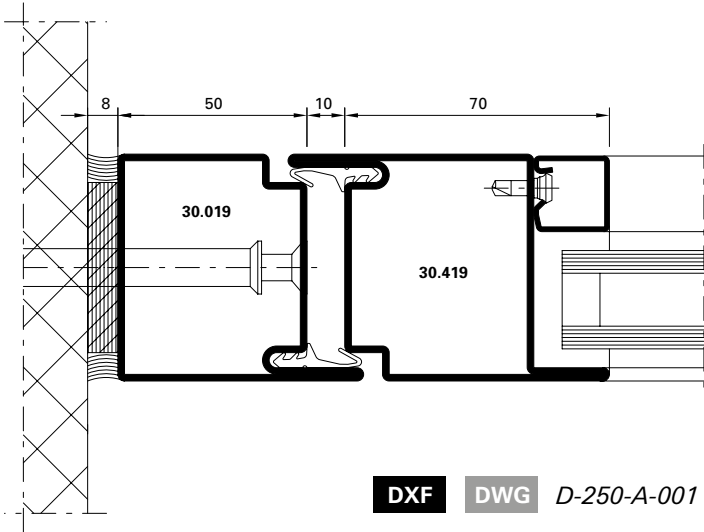

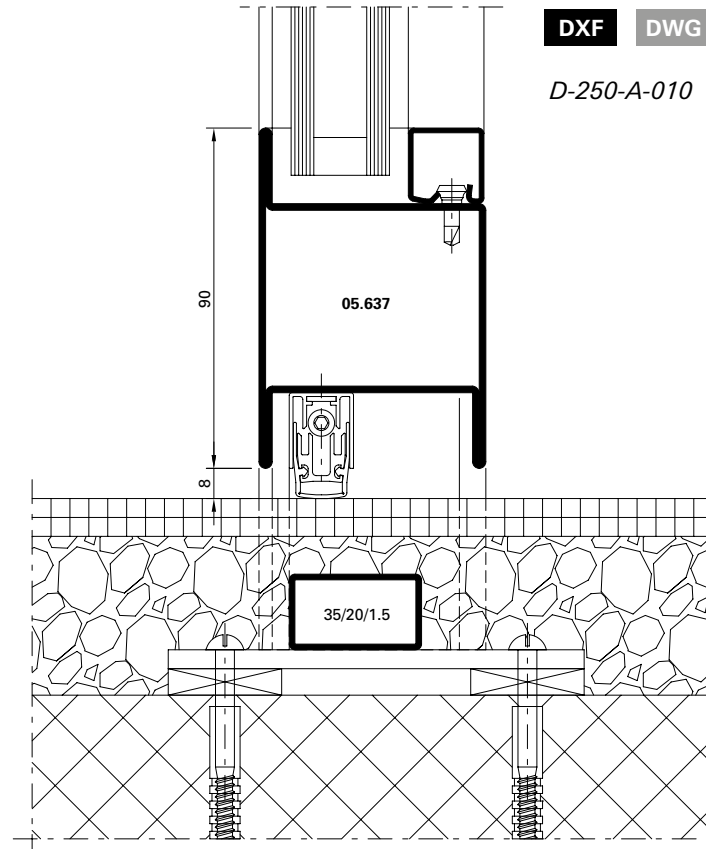
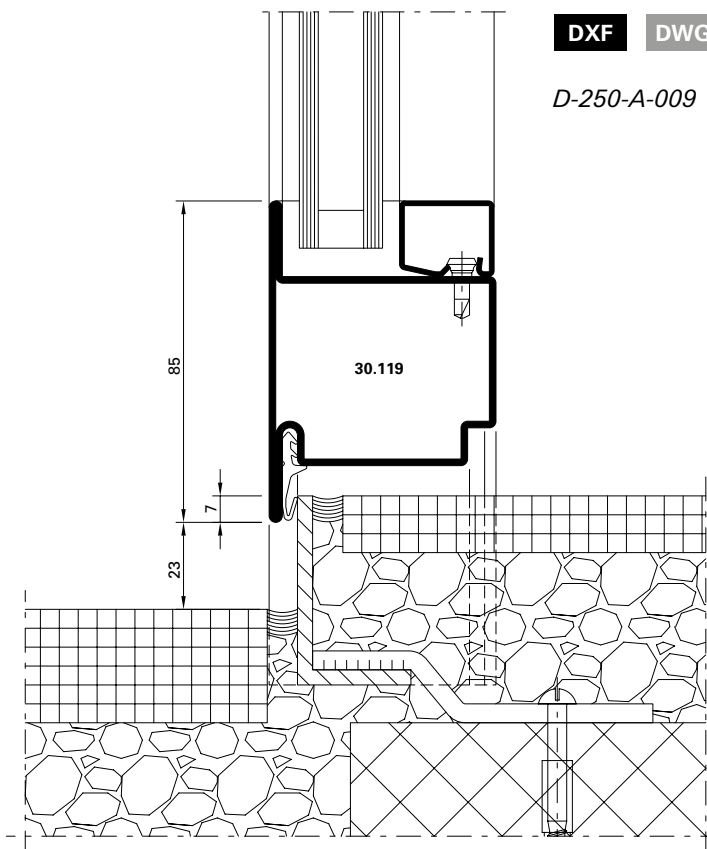
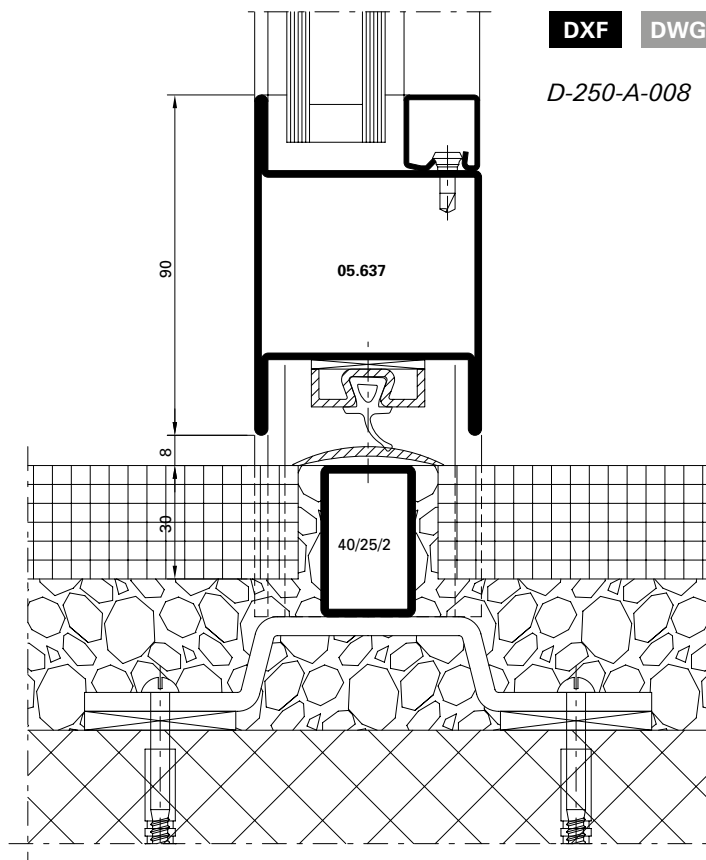
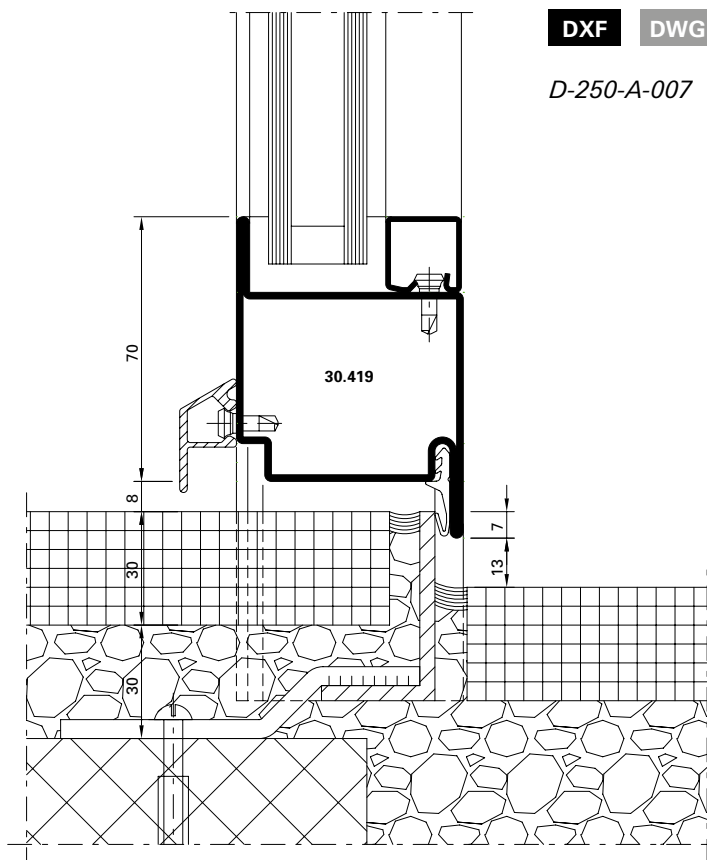



Einflügelige Türen,
 auswärts öffnend,
 Flügelhöhe ≤ 2200 mm

Porte à un vantail,
 ouvrant vers l'extérieur,
 hauteur du vantail ≤ 2200 mm

Single leaf door,
 outward opening,
 leaf height ≤ 2200 mm

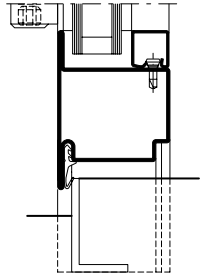
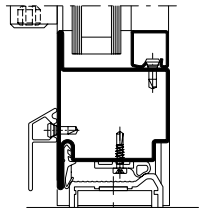
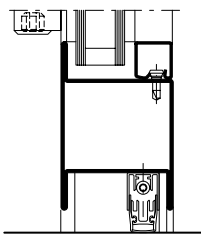
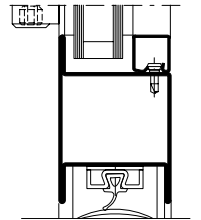
Variante	Beschlag Ferrure Fitting	 EN 12207	 EN 12208	 EN 12210	
Anschlagdichtung Joint de butée Rebate gasket		1	2	1A	C4
		2	2	2A	C4
		3	3	2A	C5
Doppel-Anschlagdichtung Joint de base double Double rebate gasket		1	4	3A	C4
		2	4	3A	C4
		3	4	5A	C5
Senkdichtung Joint seuil Drop seal		1	2	1A	C4
		2	2	2A	C4
		3	3	2A	C5
Auflaufdichtung Joint de contact Ramp seal		1	2	0	C4
		2	2	0	C4
		3	2	0	C5

1 Fallenriegel-Schloss
 Serrure à mortaiser
 Latch and bolt lock





2 Schloss mit Obenverriegelung
 Serrure avec verrouillage supérieur
 Lock with top locking point

3 Mehrfachverriegelungs-Schloss
 Serrure à verrouillage multiple
 Multipoint lock

Einflügelige Türen,
 einwärts öffnend,
 Flügelhöhe ≤ 2200 mm

Porte à un vantail,
 ouvrant vers l'intérieur,
 hauteur du vantail ≤ 2200 mm

Single leaf door,
 inward opening,
 leaf height ≤ 2200 mm

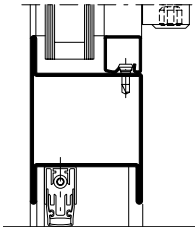
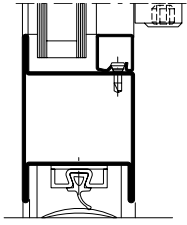
Variante		Beschlag Ferrure Fitting	 EN 12207	 EN 12208	 EN 12210
Senkdichtung Joint seuil Drop seal		❶	2	0	C4
		❷	2	0	C4
		❸	3	1A	C5
Auflaufdichtung Joint de contact Ramp seal		❶	2	0	C4
		❷	2	0	C4
		❸	2	0	C5

❶ Fallenriegel-Schloss
 Serrure à mortaiser
 Latch and bolt lock



❷ Schloss mit Obenverriegelung
 Serrure avec verrouillage supérieur
 Lock with top locking point

❸ Mehrfachverriegelungs-Schloss
 Serrure à verrouillage multiple
 Multipoint lock

Einflügelige Türen,
 auswärts öffnend,
 Flügelhöhe ≤ 3000 mm

Porte à un vantail,
 ouvrant vers l'extérieur,
 hauteur du vantail ≤ 3000 mm

Single leaf door,
 outward opening,
 leaf height ≤ 3000 mm

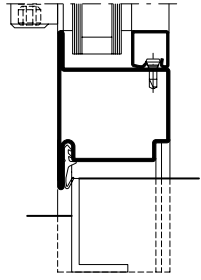
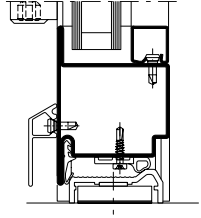
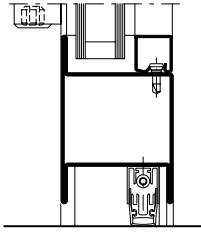
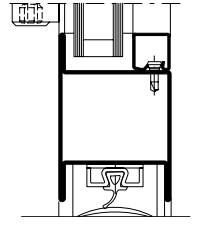
Variante	Beschlag Ferrure Fitting	 EN 12207	 EN 12208	 EN 12210
Anschlagdichtung Joint de butée Rebate gasket 	1	1	0	C1
	2	1	0	C1
	3	1	0	C2
Doppel-Anschlagdichtung Joint de base double Double rebate gasket 	1	1	1A	C1
	2	1	1A	C1
	3	2	2A	C2
Senkdichtung Joint seuil Drop seal 	1	1	0	C1
	2	1	0	C1
	3	1	0	C2
Aufbaudichtung Joint de contact Ramp seal 	1	0	0	C1
	2	0	0	C1
	3	1	0	C2

1 Fallenriegel-Schloss
 Serrure à mortaiser
 Latch and bolt lock





2 Schloss mit Obenverriegelung
 Serrure avec verrouillage supérieur
 Lock with top locking point

3 Mehrfachverriegelungs-Schloss
 Serrure à verrouillage multiple
 Multipoint lock

Einflügelige Türen,
 einwärts öffnend,
 Flügelhöhe ≤ 3000 mm

Porte à un vantail,
 ouvrant vers l'intérieur,
 hauteur du vantail ≤ 3000 mm

Single leaf door,
 inward opening,
 leaf height ≤ 3000 mm

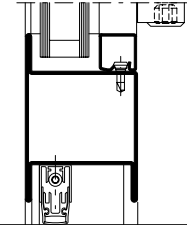
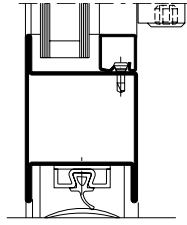
Variante		Beschlag Ferrure Fitting	 EN 12207	 EN 12208	 EN 12210
Senkdichtung Joint seuil Drop seal		❶	1	0	C1
		❷	1	0	C1
		❸	1	0	C2
Auflaufdichtung Joint de contact Ramp seal		❶	0	0	C1
		❷	0	0	C1
		❸	1	0	C2

❶ Fallenriegel-Schloss
 Serrure à mortaiser
 Latch and bolt lock



❷ Schloss mit Obenverriegelung
 Serrure avec verrouillage supérieur
 Lock with top locking point

❸ Mehrfachverriegelungs-Schloss
 Serrure à verrouillage multiple
 Multipoint lock

Zweiflügelige Türen,
 auswärts öffnend,
 Flügelhöhe ≤ 2200 mm

Porte à deux vantaux,
 ouvrant vers l'extérieur,
 hauteur du vantail ≤ 2200 mm

Double leaf door,
 outward opening,
 leaf height ≤ 2200 mm

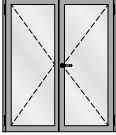
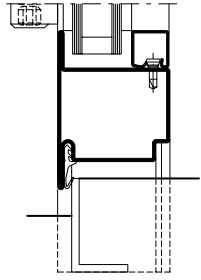
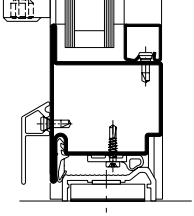
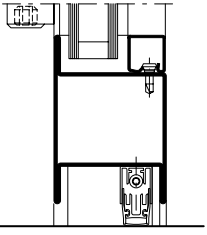
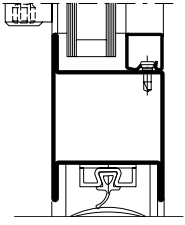
Variante	Beschlag Ferrure Fitting	 EN 12207	 EN 12208	 EN 12210	
					
Anschlagdichtung Joint de butée Rebate gasket		1	2	1A	C2
		2	2	2A	C2
		3	2	2A	C3
Doppel-Anschlagdichtung Joint de base double Double rebate gasket		1	2	2A	C2
		2	2	2A	C2
		3	3	3A	C3
Senkdichtung Joint seuil Drop seal		1	2	1A	C2
		2	2	2A	C2
		3	2	2A	C3
Auflaufdichtung Joint de contact Ramp seal		1	2	0	C2
		2	2	0	C2
		3	2	0	C3

1 Fallenriegel-Schloss
 Serrure à mortaiser
 Latch and bolt lock





2 Schloss mit Obenverriegelung
 Serrure avec verrouillage supérieur
 Lock with top locking point

3 Mehrfachverriegelungs-Schloss
 Serrure à verrouillage multiple
 Multipoint lock

Zweiflügelige Türen,
 einwärts öffnend,
 Flügelhöhe ≤ 2200 mm

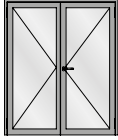
Porte à deux vantaux,
 ouvrant vers l'intérieur,
 hauteur du vantail ≤ 2200 mm

Double leaf door,
 inward opening,
 leaf height ≤ 2200 mm

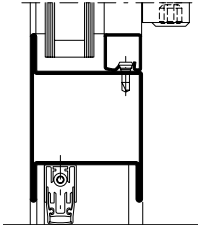
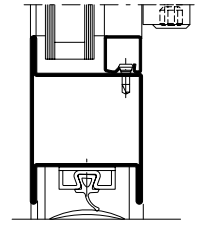
Variante		Beschlag Ferrure Fitting	 EN 12207	 EN 12208	 EN 12210
Senkdichtung Joint seuil Drop seal		❶	2	0	C2
		❷	2	0	C2
		❸	2	0	C3
Auflaufdichtung Joint de contact Ramp seal		❶	2	0	C2
		❷	2	0	C2
		❸	2	0	C3

❶ Fallenriegel-Schloss
 Serrure à mortaiser
 Latch and bolt lock



❷ Schloss mit Obenverriegelung
 Serrure avec verrouillage supérieur
 Lock with top locking point

❸ Mehrfachverriegelungs-Schloss
 Serrure à verrouillage multiple
 Multipoint lock

Zweiflügelige Türen,
 auswärts öffnend,
 Flügelhöhe ≤ 3000 mm

Porte à deux vantaux,
 ouvrant vers l'extérieur,
 hauteur du vantail ≤ 3000 mm

Double leaf door,
 outward opening,
 leaf height ≤ 3000 mm

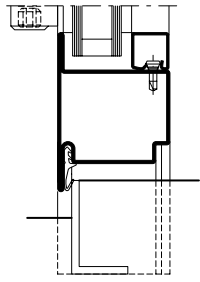
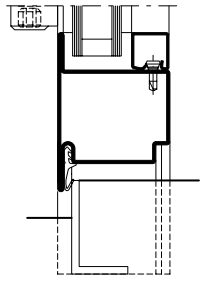
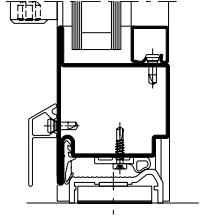
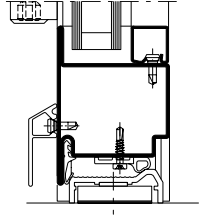
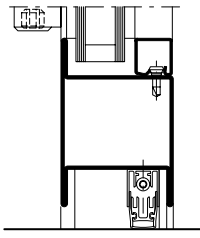
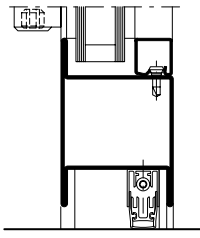
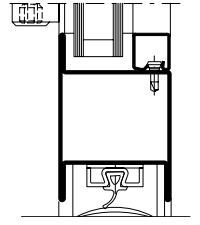
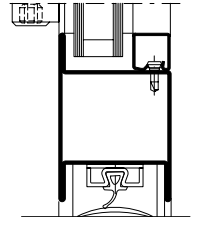
Variante	Beschlag Ferrure Fitting	 EN 12207	 EN 12208	 EN 12210		
Anschlagdichtung Joint de butée Rebate gasket 	Beschlag Ferrure Fitting 	1	0	0	C1	
		2	0	0	0	C1
		3	1	0	0	C2
Doppel-Anschlagdichtung Joint de base double Double rebate gasket 	Beschlag Ferrure Fitting 	1	1	0	C1	
		2	1	0	0	C1
		3	2	0	0	C2
Senkdichtung Joint seuil Drop seal 	Beschlag Ferrure Fitting 	1	0	0	C1	
		2	0	0	0	C1
		3	1	0	0	C2
Aufaufdichtung Joint de contact Ramp seal 	Beschlag Ferrure Fitting 	1	0	0	C1	
		2	0	0	0	C1
		3	1	0	0	C2

1 Fallenriegel-Schloss
 Serrure à mortaiser
 Latch and bolt lock





2 Schloss mit Obenverriegelung
 Serrure avec verrouillage supérieur
 Lock with top locking point

3 Mehrfachverriegelungs-Schloss
 Serrure à verrouillage multiple
 Multipoint lock

Zweiflügelige Türen,
 einwärts öffnend,
 Flügelhöhe ≤ 3000 mm

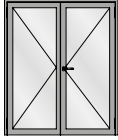
Porte à deux vantaux,
 ouvrant vers l'intérieur,
 hauteur du vantail ≤ 3000 mm

Double leaf door,
 inward opening,
 leaf height ≤ 3000 mm

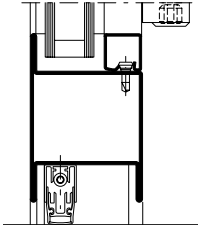
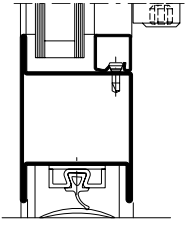
Variante		Beschlag Ferrure Fitting	 EN 12207	 EN 12208	 EN 12210
Senkdichtung Joint seuil Drop seal		1	0	0	C1
		2	0	0	C1
		3	1	0	C2
Auflaufdichtung Joint de contact Ramp seal		1	0	0	C1
		2	0	0	C1
		3	1	0	C2

U_f-Werte
(nach EN ISO 10077-2:2018-01)

Valeurs U_f
(selon EN ISO 10077-2:2018-01)

U_f values
(according to
EN ISO 10077-2:2018-01)

Auf den folgenden Seiten
finden Sie die U_f-Werte für die
verschiedenen Anwendungen von
Jansen-Economy 60.

Vous trouverez les valeurs U_f
pour les différentes applications
Jansen-Economy 60 dans les
pages qui suivent.

On the following pages you
will find the U_f values for the
various applications for
Jansen-Economy 60.

Sie basieren auf folgenden
Grundlagen:

Elles se basent sur les principes
suivants:

They are based on the following:

Stahl

- Profile bandverzinkter Stahl,
unbeschichtet
- Stahl-Glasleisten
- Trockenverglasung
- Nassverglasung

Acier

- Profilés en bande d'acier zingué,
sans revêtement
- Parcloses en acier
- Vitrage à sec
- Vitrage à mastic



Steel

- Strip galvanised steel profiles,
uncoated
- Steel glazing beads
- Glazing with dry glazing
- Glazing with sealing

U_f-Werte
 (nach EN ISO 10077-2:2018-01)

Valeurs U_f
 (selon EN ISO 10077-2:2018-01)

U_f values
 (according to EN ISO 10077-2:2018-01)

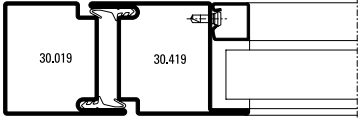
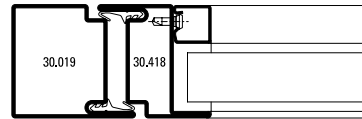
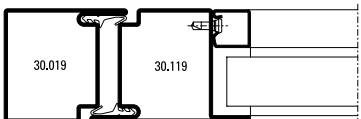
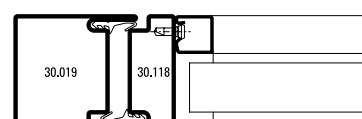
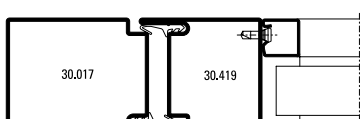
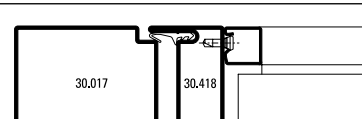
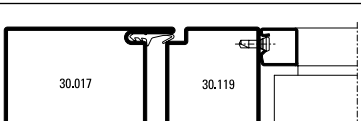
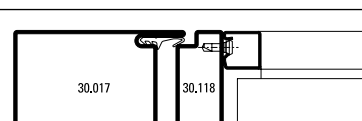
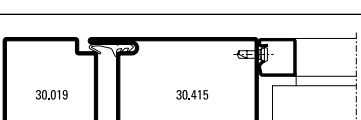
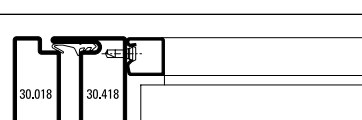
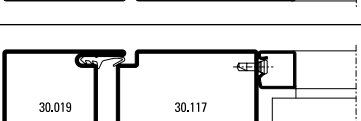
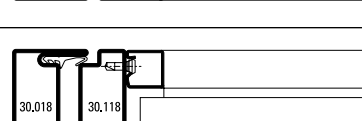
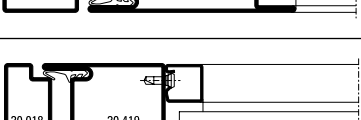
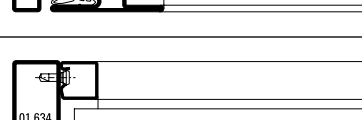
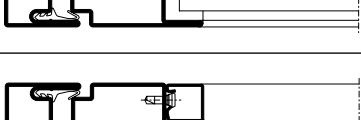
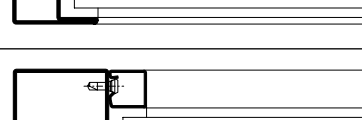
 Füllelementstärken Elements de remplissages Infill elements ≥ 24 mm		 Füllelementstärken Elements de remplissages Infill elements ≥ 24 mm	
	5,5 W/m ² K		5,7 W/m ² K
	5,6 W/m ² K		5,8 W/m ² K
	5,3 W/m ² K		5,5 W/m ² K
	5,3 W/m ² K		5,5 W/m ² K
	5,3 W/m ² K		6,0 W/m ² K
	5,3 W/m ² K		6,1 W/m ² K
	5,6 W/m ² K		6,9 W/m ² K
	5,7 W/m ² K		6,1 W/m ² K

U_f-Werte
 (nach EN ISO 10077-2:2018-01)

Valeurs U_f
 (selon EN ISO 10077-2:2018-01)

U_f values
 (according to EN ISO 10077-2:2018-01)

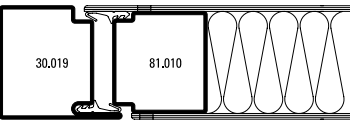
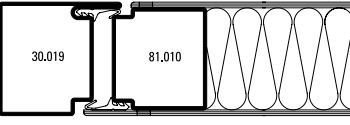
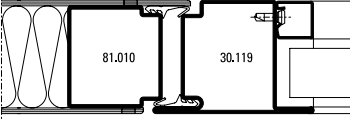
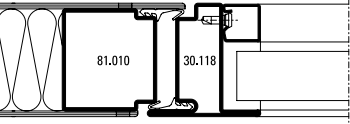
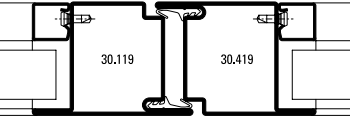
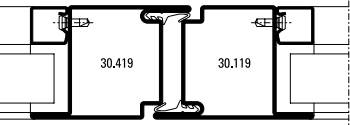
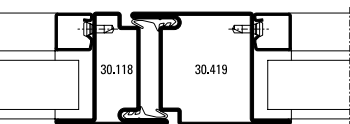
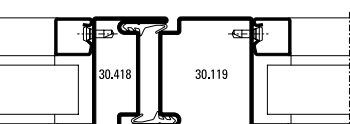
	Füllelementstärken Elements de remplissages Infill elements ≥ 24 mm
	5,3 W/m²K
	5,3 W/m²K
	5,7 W/m²K
	6,0 W/m²K
	5,8 W/m²K
	5,8 W/m²K
	6,1 W/m²K
	6,1 W/m²K

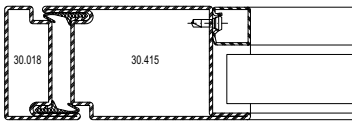
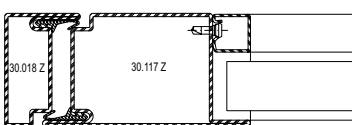
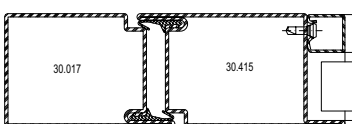
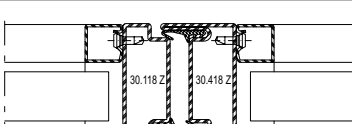
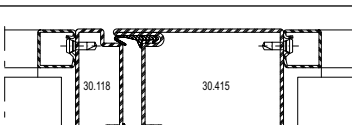
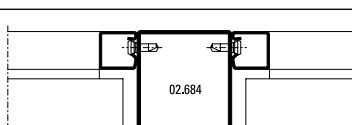
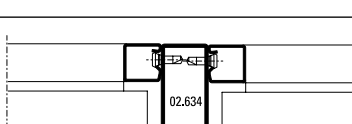
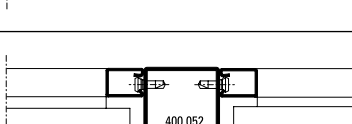
	Füllelementstärken Elements de remplissages Infill elements ≥ 24 mm
	5,3 W/m²K
	5,4 W/m²K
	5,1 W/m²K
	6,5 W/m²K
	5,7 W/m²K
	6,3 W/m²K
	7,2 W/m²K
	6,4 W/m²K

U_f-Werte
 (nach EN ISO 10077-2:2018-01)

Valeurs U_f
 (selon EN ISO 10077-2:2018-01)

U_f values
 (according to EN ISO 10077-2:2018-01)

	Füllelementstärken Elements de remplissages Infill elements ≥ 24 mm
	5,5 W/m²K
	5,7 W/m²K
	5,5 W/m²K
	5,3 W/m²K
	5,3 W/m²K

	Füllelementstärken Elements de remplissages Infill elements ≥ 24 mm
	5,8 W/m²K
	6,0 W/m²K
	5,4 W/m²K
	5,1 W/m²K

U_f-Werte
 (nach EN ISO 10077-2:2018-01)

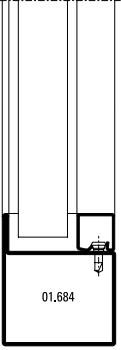
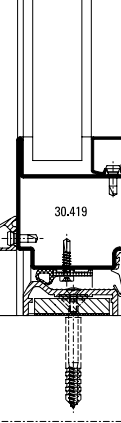
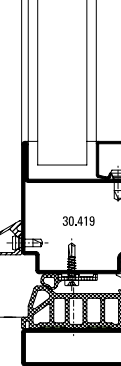
 Füllelementstärken Elements de remplissages Infill elements ≥ 24 mm	
 01.684	6,1 W/m ² K
 30.419	6,3 W/m ² K
 30.419	5,6 W/m ² K

Valeurs U_f
 (selon EN ISO 10077-2:2018-01)

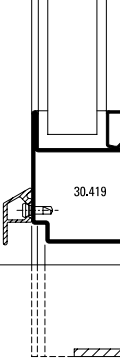
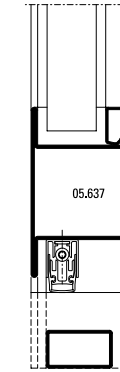
 Füllelementstärken Elements de remplissages Infill elements ≥ 24 mm	
 30.419	6,3 W/m ² K
 05.637	5,6 W/m ² K

U_f values
 (according to EN ISO 10077-2:2018-01)

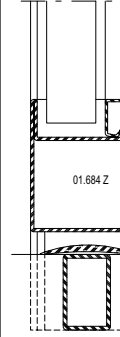
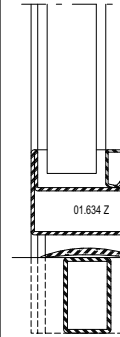
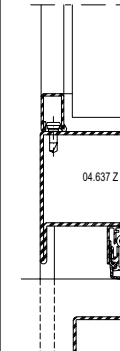
 Füllelementstärken Elements de remplissages Infill elements ≥ 24 mm	
 01.684 Z	6,1 W/m ² K
 01.634 Z	6,8 W/m ² K
 04.637 Z	5,5 W/m ² K

U_f-Werte
 (nach EN ISO 10077-2:2018-01)

Valeurs U_f
 (selon EN ISO 10077-2:2018-01)

U_f values
 (according to EN ISO 10077-2:2018-01)

	Füllelementstärken Elements de remplissages Infill elements ≥ 24 mm
	5,6 W/m ² K

	Füllelementstärken Elements de remplissages Infill elements ≥ 24 mm
	5,6 W/m ² K

	Füllelementstärken Elements de remplissages Infill elements ≥ 24 mm
	5,7 W/m ² K

	4,4 W/m ² K
--	------------------------

	5,7 W/m ² K
--	------------------------

	5,2 W/m ² K
--	------------------------



Schallschutz

Ausführungsvarianten

Die nachfolgende Typenübersicht ergibt einen Überblick über die beurteilten Varianten.

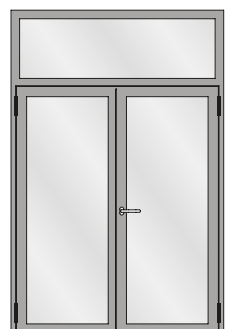
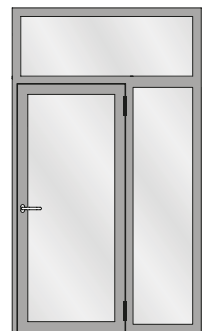
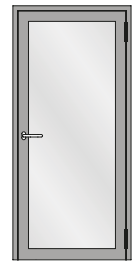

Isolation phonique

Modèles

L'aperçu des types suivant fournit une vue d'ensemble des variantes examinées.

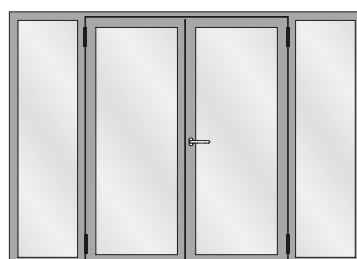
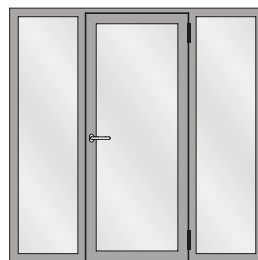
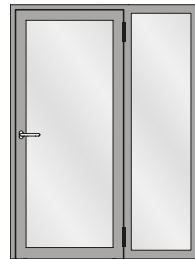
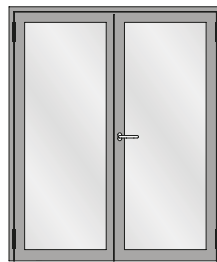

Sound insulation

Design range

The following overview of types provides an overview of the evaluated designs.

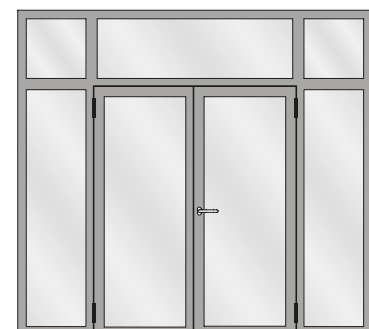
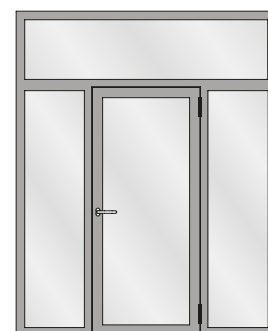

Schallschutz

Isolation phonique

Sound insulation

Tabelle A1

Korrekturtabelle für Jansen-Economy-Türen mit Glasfüllungen

Tableau A1

Tableau de correction pour les portes Jansen-Economy avec vitrage

Table A1

Correction table for Jansen-Economy doors with glass

	1	2	3	4	5	6	7	8	9	10	11
	Türe mit zwei absenkba- ren Bodendichtungen Porte avec deux joint seuil automatique Door with two threshold gaskets that can be lowered	Glas Verre Glass	Korrekturen Corrections Corrections								
	$R_{w(C, Ctr)}$ dB	$R_{w, P, Glas}$ dB	K_S dB	K_{FV} dB	K_{Nass} dB	K_{1aB} dB	$K_{W/S}$ dB	$K_{G 0,4}$ dB	$K_{G 1,8}$ dB	$K_{G 2,6}$ dB	$K_{G 3,2}$ dB
1	32 (-1; -5)	31	0	-1	0	0	0	0	-1	-2	-3
2	33 (-1; -5)	32	0	-1	0	0	0	0	-1	-2	-3
3	35 (-1; -5)	34	0	-1	0	0	0	0	-1	-2	-3
4	36 (-2; -5)	35	0	-1	-1	0	0	0	-1	-2	-3
5	37 (-2; -5)	37	0	0	-1	0	-1	0	-1	-2	-3
6	38 (-2; -5)	39	0	0	-1	-1	-1	0	-1	-2	-3
7	39 (-2; -5)	40	0	0	-1	-1	-1	0	-1	-2	-3
8	40 (-2; -5)	41	0	0	-1	-1	-2	-1	-1	-2	-3
9	41 (-2; -5)	42	0	0	-1	-1	-2	-2	-1	-2	-3
10	42 (-2; -5)	43	-1	0	-1	-1	-2	-2	-1	-2	-3
11	42 (-2; -5)	44	-1	0	-1	-1	-2	-2	-1	-2	-3
12	43 (-2; -5)	45	-1	+1	-1	-1	-3	-3	-1	-2	-3
13	44 (-2; -5)	49	-1	+1	-1	-2	-3	-3	-1	-2	-3

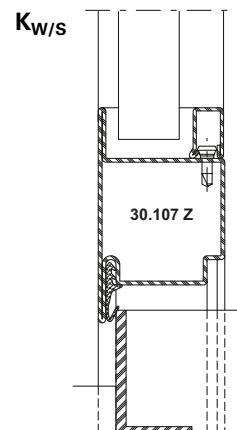
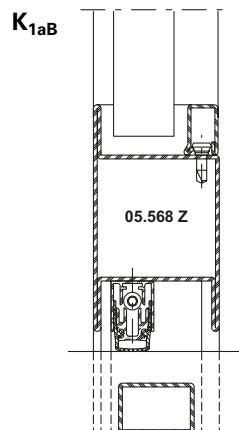
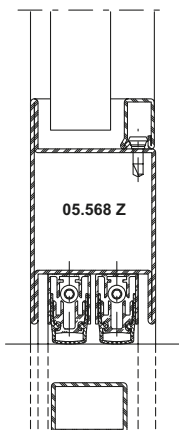

Schallschutz

Der aus der Tabelle A1 abzulesende Wert für die Schalldämmung $R_{w, Tür}$ beträgt:

Isolation phonique

La valeur à relever sur le tableau A1 concernant l'isolement contre les sons aériens $R_{w, Porte}$ est la suivante:

Sound insulation

The value taken from table A1 for the sound insulation $R_{w, Door}$ is:

$$R_{w, Tür} = R_w + K_S + K_{FV} + K_{Nass} + K_{1aB} + K_{W/S} + K_{Band} + K_{G 0,4} + K_{G 1,8} + K_{G 2,6} + K_{G 3,2} \text{ dB}$$

- R_w** bewertetes Schalldämm-Mass der Türe in Abhängigkeit von der Schalldämmung $R_{w,P, Glas}$
- $R_{w,P, Glas}$** bewertetes Schalldämm-Mass der Verglasung (Prüfwert nach ISO 140-3, mit Prüfnachweis einer PÜZ-Stelle). Alternativ können Tabellenwerte nach DIN EN 12758, Abschnitt 6 verwendet werden
- K_S** Korrekturwert für zweiflügelige Türen
- K_{FV}** Korrekturwert für Festverglasungen mit erhöhtem Scheibenanteil
- K_{Nass}** Korrekturwert für Nassverglasung
- K_{1aB}** Korrekturwert für Türen mit einer absenkbaren Bodendichtung
- K_{Band}** Korrekturwert bei Verwendung von Anschlagbändern, die eine Dichtungsebene unterbrechen ($K_{Band} = - 0,5 \text{ dB pro Band}$)
- $K_{W/S}$** Korrekturwert für Türen mit einer Anschlagsschwelle
- $K_{G 0,4}$** Korrekturwert für Einzelscheiben mit einer Glasfläche $\leq 0,4 \text{ m}^2$. Die Korrektur gilt auch für Konstruktionen mit glasteilenden Sprossen.
- $K_{G 1,8}$** Korrekturwert für Einzelscheiben mit einer Glasfläche $\geq 1,8 \text{ m}^2$
- $K_{G 2,6}$** Korrekturwert für Einzelscheiben mit einer Glasfläche $\geq 2,6 \text{ m}^2$
- $K_{G 3,2}$** Korrekturwert für Einzelscheiben mit einer Glasfläche $\geq 3,2 \text{ m}^2$

- R_w** Mesure d'isolement contre les sons aériens des portes évaluée suivant l'isolement phonique $R_{w,P, Glas}$
- $R_{w,P, Glas}$** Cote d'isolement acoustique du vitrage évalué (valeur contrôlée selon ISO 140-3 avec certificat d'un bureau de contrôle, de surveillance ou de certification). Il est également possible d'utiliser les valeurs selon le tableau DIN EN 12758, section 6
- K_S** Valeur de correction pour portes à deux vantaux
- K_{FV}** Valeur de correction pour vitrages fixes à fort pourcentage de vitre
- K_{Nass}** Valeur de correction pour vitrage avec mastic
- K_{1aB}** Valeur de correction pour portes avec un joint seuil automatique
- K_{Band}** Valeur corrective en cas d'utilisation de paumelles qui interrompent un plan d'étanchéité ($K_{Band} = - 0,5 \text{ dB par paumelle}$)
- $K_{W/S}$** Valeur de correction pour portes avec un seuil de butée
- $K_{G 0,4}$** Valeur de correction pour vitres individuelles avec une surface vitrée $\leq 0,4 \text{ m}^2$. La correction s'applique aussi aux constructions à meneaux séparant les vitres.
- $K_{G 1,8}$** Valeur de correction pour vitres individuelles avec surface vitrée $\geq 1,8 \text{ m}^2$
- $K_{G 2,6}$** Valeur de correction pour vitres individuelles avec surface vitrée $\geq 2,6 \text{ m}^2$
- $K_{G 3,2}$** Valeur de correction pour vitres individuelles avec surface vitrée $\geq 3,2 \text{ m}^2$

- R_w** Airborne sound reduction index of doors depending on the sound insulation $R_{w,P, Glas}$
- $R_{w,P, Glas}$** Airborne sound reduction index (test value in accordance with ISO 140-3, with a test certificate from a recognised testing, inspection or certification body). Alternatively, the tabulated values in DIN EN 12758, Section 6 may be used
- K_S** Correction value for double-leaf doors
- K_{FV}** Correction value for fixed glazing with increased proportion of pane
- K_{Nass}** Correction value for glazing with sealing
- K_{1aB}** Correction value for doors with a threshold gasket that can be lowered
- K_{Band}** Correction value when using hinges that interrupt a sealing plane ($K_{Band} = - 0.5 \text{ dB per hinge}$)
- $K_{W/S}$** Correction value for doors with a rebate threshold
- $K_{G 0,4}$** Correction value for single panes with a glass area $\leq 0,4 \text{ m}^2$. The correction also applies to buildings with glazing bars
- $K_{G 1,8}$** Correction value for single panes with a glass area $\geq 1,8 \text{ m}^2$
- $K_{G 2,6}$** Correction value for single panes with a glass area $\geq 2,6 \text{ m}^2$
- $K_{G 3,2}$** Correction value for single panes with a glass area $\geq 3,2 \text{ m}^2$

Jansen-Economy 60 Türen

Türen aus Stahl

Portes Jansen-Economy 60

Portes en acier

Jansen-Economy 60 doors

Doors in steel

Grafische Planungsdaten wie z.B. Anwendungsbeispiele, Konstruktionsdetails, Anschlüsse am Bau, die in unseren physischen oder elektronischen Dokumentationsunterlagen enthalten sind, sind schematische Darstellungen. Gleiches gilt für digitale Medien wie CAD Dateien oder BIM Modelle.

Sie sollen den ausführenden Metallbauer und/oder Fachplaner bei der Planung und Ausführung eines Projektes unterstützen. Sie sind im konkreten Anwendungsfall durch den ausführenden Metallbauer und/oder Fachplaner auf die Verwendbarkeit im konkreten betroffenen Projekt hinsichtlich rechtlichen/regulatorischen aber auch technischen objektspezifischen Anforderungen zu überprüfen und ggfs. eigenverantwortlich anzupassen.

Bei der Überprüfung, der spezifischen Planung und der Umsetzung sind die objektspezifischen Rahmenbedingungen (Material der Bausubstanz, Dimension des Einbauelements, Farbe, Exposition, Lasteinwirkung, etc.) sowie der geltende Stand der Technik einschliesslich aller anwendbaren Normen und technischen Richtlinien eigenverantwortlich zu beachten.

Falls das vorliegende Dokument Differenzen zur aktuellen deutschen Version (Artikel Nr. K1214237) aufweist, gilt in jedem Fall der deutsche Originaltext in der jeweils geltenden Fassung im Jansen Docu Center.

Alle Ausführungen dieser Dokumentation haben wir sorgfältig und nach bestem Wissen zusammengestellt. Wir können aber keine Verantwortung für die Benutzung der vermittelten Vorschläge und Daten übernehmen. Wir behalten uns technische Änderungen ohne Vorankündigung vor.

Les données de planification graphiques, comme les exemples d'application, détails de construction et raccordements au bâtiment, fournies dans notre documentation physique et numérique sont des représentations schématiques. Il en va de même pour les médias numériques comme les fichiers CAD ou modèles BIM.

Leur but est de faciliter la planification et réalisation d'un projet par les constructeurs métalliques et/ou concepteurs. Concrètement, elles doivent être vérifiées par le constructeur métallique et/ou le concepteur et, le cas échéant, modifiées de son propre chef pour s'assurer qu'elles concordent avec le projet concerné et qu'elles répondent aux exigences techniques spécifiques ainsi qu'aux dispositions légales et réglementaires.

Lors de la vérification, de la planification spécifique et de la mise en œuvre, il y a lieu de tenir compte des conditions spécifiques à l'objet (matériaux du bâtiment, dimension de l'élément d'insert, couleur, exposition, effet de charge, etc.) ainsi que de l'état actuel de la technique, y compris toutes les normes et directives techniques applicables.

En cas de divergence entre le présent document et la version allemande (no d'article K1214237), c'est dans tous les cas le texte original allemand qui prévaut dans sa version actuelle disponible dans le Jansen Docu Center.

Nous avons apporté le plus grand soin à l'élaboration de cette documentation. Cependant, nous déclinons toute responsabilité pour l'utilisation faite de nos propositions et de nos données.

Nous nous réservons le droit de procéder à des modifications techniques sans préavis.

Graphical planning data such as application examples, construction details, connections on site that are contained in our physical or electronic documentation components are schematic representations. The same applies to digital media such as CAD files or BIM models.

They are intended to support the metal worker and/or design engineer in planning and executing projects. In the specific case of application they are to be checked by the metal worker and/or design engineer in terms of their usability in the specific project concerned with regard to legal/regulatory and technical property-specific requirements and adjusted if necessary at the latter's own responsibility.

The property-specific underlying conditions (construction material, dimensions of installation element, colour, exposure, load effect etc.) and current state of the art including all applicable norms and technical guidelines are to be taken into consideration at the metal worker and/or design engineer's own responsibility during the review, specific planning and implementation.

If there are any differences between this document and the current German version (item number K1214237), the latest version of the original German text in the Jansen Docu Center shall prevail.

All the information contained in this documentation is given to the best of our knowledge and ability. However, we decline all responsibility for the use made of these suggestions and data.

We reserve the right to effect technical modifications without prior warning.

Inhaltsverzeichnis Sommaire Content	Jansen-Economy 60 Türen Jansen-Economy 60 portes Jansen-Economy 60 doors	2	
Systemübersicht Merkmale Leistungseigenschaften Systemausführungen Typenübersicht	Sommaire du système Caractéristiques Caractéristiques de performance Exécutions de système Sommaire des types	Summary of system Characteristics Performance characteristics System versions Summary of types	2
Profilsortiment	Assortiment de profilé	Range of profiles	14
Beispiele Schnittpunkte Konstruktionsdetails Anschlüsse am Bau	Exemples Coupes de détails Détails de construction Raccords au mur	Examples Section details Construction details Attachment to structure	18
Leistungseigenschaften	Caractéristiques de performance	Performance characteristics	36







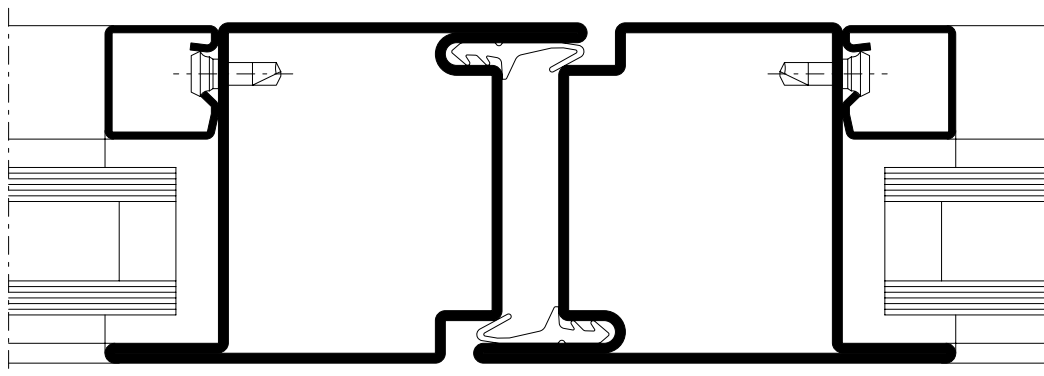

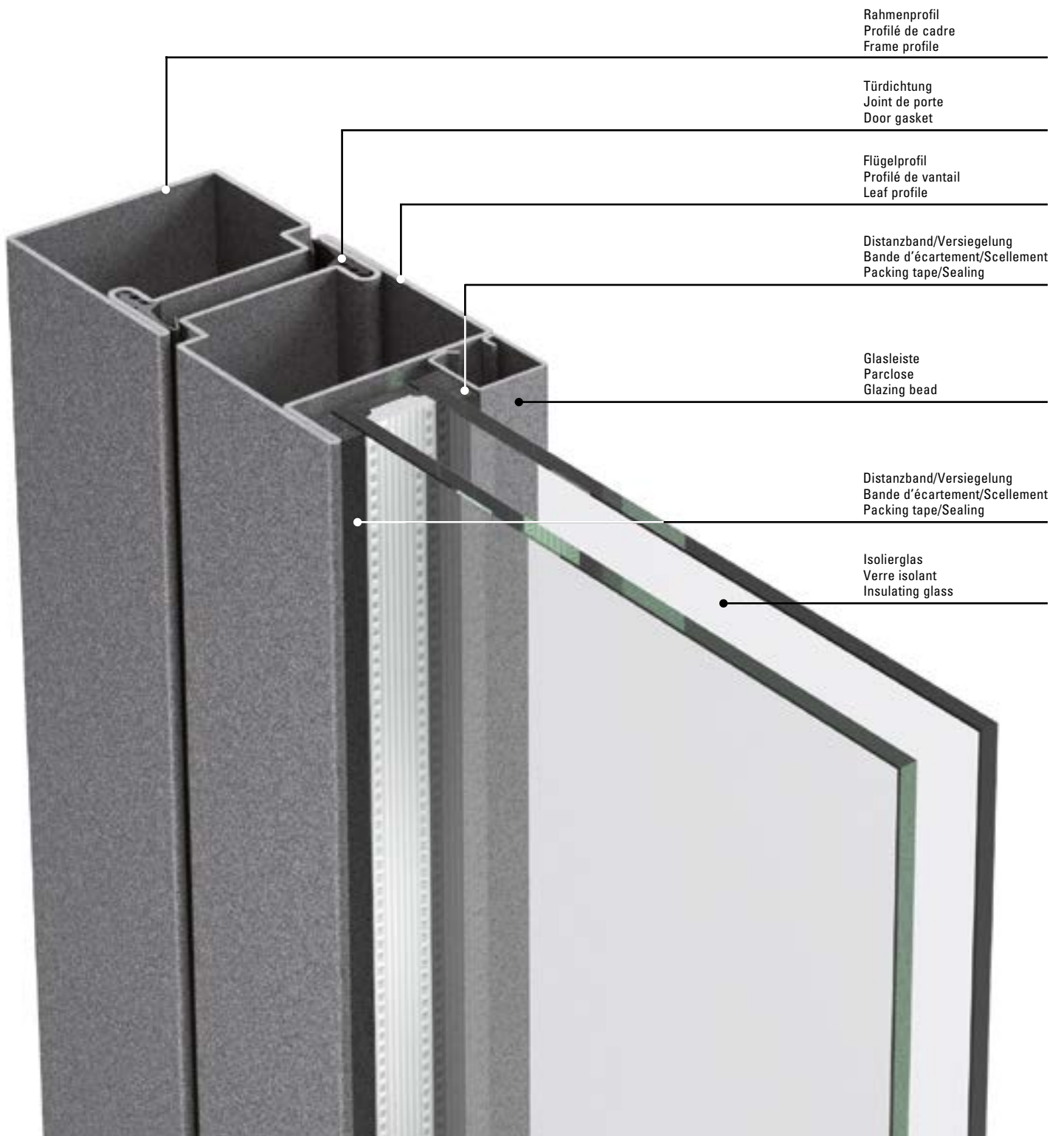

Merkmale
Caractéristiques
Characteristics



Jansen-Economy 60 Türen
Jansen-Economy 60 portes
Jansen-Economy 60 doors

- Stahlsystem für Türen und Festverglasungen
- Bautiefe 60 mm, innen und aussen flächenbündig
- Schmale Ansichtsbreiten: Rahmen und Flügel ab 105 mm Stulppartie 150 mm
- Ein- und zweiflüglige Türen, nach innen und aussen öffnend, mit Oberlicht oder Festverglasung kombinierbar
- Türflügel bis 1465 x 3000 mm (BxH), Flügelgewicht bis 230 kg
- Füllelementstärke von 5 bis 36 mm, Glaseinbau mittels Trocken- oder Nassverglasung
- Systemprüfungen nach Produktnorm EN 14351-1
- Stahlprofile blank oder bandverzinkt
- Grosses Sortiment an systemgeprüften Türbeschlägen
- Barrierefreie Schwellenausbildungen
- Geeignet für Pulver- und Nasslackbeschichtungen
- Système en acier pour portes et vitrages fixes
- Profondeur de montage 60 mm, montage à fleur à l'intérieur et à l'extérieur
- Fines largeurs de face: Cadre et vantaux à partir de 105 mm Partie tête 150 mm
- Portes à un et deux vantaux, ouverture vers l'intérieur et vers l'extérieur, combinables avec imposte ou vitrage fixe
- Vantaux de porte jusqu'à 1465 x 3000 mm (LaxH), poids du vantail jusqu'à 230 kg
- Élément de remplissage de 5 à 36 mm d'épaisseur, Montage du vitrage à sec ou à silicone
- Contrôles des systèmes selon la norme produit EN 14351-1
- Profilés en acier brut ou galvanisé en continu
- Grand assortiment de ferrures de porte homologuées
- Formes de seuil sans barrière
- Convient aux revêtements par poudre ou peinture liquide
- Steel system for doors and fixed glazing
- 60 mm basic depth, flush-fitted on the inside and outside
- Narrow face widths: Frame and leaf from 105 mm Meeting stile assembly 150 mm
- Single and double-leaf doors, inward and outward-opening, can be combined with toplight or fixed glazing
- Door leaf up to 1465 x 3000 mm (WxH), leaf weight up to 230 kg
- Infill unit thickness of 5 to 36 mm, Glazing installed by means of dry or wet glazing
- System tests in accordance with the product standard EN 14351-1
- Raw finish or pre-galvanised steel profiles
- Large range of system-tested door fittings
- Easy-access thresholds
- Suitable for powder and wet paint coating





Norm	Eigenschaft Caractéristique Characteristic	Klassifizierung/Wert Classification / Valeur Classification / Value											
 EN 12210	Widerstandsfähigkeit bei Windlast Résistance à la pression du vent Resistance to wind load	npd	1 (400)	2 (800)	3 (1200)	4 (1600)	5 (2000)	Exxx (>2000)					
 EN 12208	Schlagregendichtheit Etanchéité à la pluie battante Watertightness	npd	1A (0)	2A (50)	3A (100)	4A (150)	5A (200)	6A (250)	7A (300)	8A (450)	9A (600)	Exxx (>750)	
 EN ISO 10140	Schalldämmung R_w (C, C_{tr}) (dB) Isolation phonique R_w (C, C_{tr}) (dB) Sound insulation R_w (C, C_{tr}) (dB)	npd	bis R_w 44 dB (-2; -5) jusqu'à R_w 44 dB (-2; -5) up to R_w 44 dB (-2; -5)										
 EN ISO 10077-2	Wärmedurchgangskoeffizient U_f (W/(m ² ·K)) Transmission thermique U_f (W/(m ² ·K)) Thermal production U_f (W/(m ² ·K))	npd	ab 5.65 W/m ² K à partir de 5.65 W/m ² K from 5.65 W/m ² K										
 EN 12207	Luftdurchlässigkeit Perméabilité à l'air Air permeability	npd	1 (150)		2 (300)		3 (600)		4 (600)				
 EN 1192	Klassifizierung der Festigkeitsanforderungen Classification des exigences de résistance méca. Classification of strength requirements	npd	1		2		3		4				
 EN 1627	Einbruchhemmung Anti-effraction Burglar resistance	npd	1		2		3		4		5		6
 EN 1522	Durchschusshemmung Résistance aux balles Bullet proofing	npd	FB1	FB2	FB3	FB4	FB5	FB6	FB7	FSG			
 EN 1191 EN 1603	Dauerfunktionsprüfung Durabilité mécanique Mechanical durability	D	1 5'000	2 10'000	3 20'000	4 50'000	5 100'000	6 200'000	7 500'000	8 1'000'000			
 EN 179 EN 1125	Fähigkeit zur Freigabe Capacité au déclenchement Ability to release		Anforderung erfüllt Exigence remplie Requirement fulfilled										

Norm	Eigenschaft Caractéristique Characteristic	Klassifizierung/Wert Classification / Valeur Classification / Value			
 EN 12217	Bedienkräfte Forces de manœuvre Operating forces	npd	0	1	2
 EN 1634-3 DIN 18095	Rauchschutz Etanchéité à la fumée Smoke control	S _a / S ₂₀₀ / RS			
 EN 16034 EN 13501-2	Selbstschliessung Fermeture automatique Self-closing	C			
 EN 16034	Dauerhaftigkeit der Selbstschliessung gegenüber Alterung (Korrosion) Endurance de la fermeture automatique contre le vieillissement (corrosion) Durability of self-closing against ageing (corrosion)	erzielt atteinte achieved			



Einbruchhemmende Jansen-Economy 60 Türen

- Türflügelgrößen 1465 x 3000 mm
- Ein- und zweiflügelige Türen, nach innen und aussen öffnend
- Geprüft nach EN 1627
- Panik- und Normalausführung

Portes anti-effraction Jansen-Economy 60

- Dimensions de vantail de porte 1465 x 3000 mm
- Portes à un/deux vantaux à ouverture vers l'intérieur et l'extérieur
- Contrôlé selon la norme EN 1627
- Exécution panique et exécution normale

Burglar-resistant Jansen Economy 60 doors

- Door leaf sizes 1465 x 3000 mm
- Single and double-leaf doors, inward and outward opening
- Tested in accordance with EN 1627
- Panic and standard design



Durchschusshemmende Jansen-Economy 60 Türen

- Türflügelgrößen 1465 x 3000 mm
- Ein- und zweiflügelige Türen, nach innen und aussen öffnend
- Geprüft nach EN 1522

Portes pare-balles Jansen-Economy 60

- Dimensions de vantail de porte 1465 x 3000 mm
- Portes à un/deux vantaux à ouverture vers l'intérieur et l'extérieur
- Contrôlé selon la norme EN 1522

Bullet-resistant Jansen Economy 60 doors

- Door leaf sizes 1465 x 3000 mm
- Single and double-leaf doors, inward and outward opening
- Tested in accordance with EN 1522



Fluchttürsysteme

- Verschlussystem für Notausgangstüren nach EN 179
- Verschlussystem für Paniktüren nach EN 1125
- Barrierefreie Türen ohne Schwelle für behindertengerechtes Bauen
- Ein- und zweiflügelige Türen nach innen und aussen öffnend
- Türflügelgrößen bis 1465 x 3000 mm und Flügelgewicht bis 230 kg

Systèmes de porte de secours

- Système de fermeture pour portes de secours selon EN 179
- Système de fermeture pour portes panique selon EN 1125
- Portes sans seuil pour faciliter l'accès aux personnes handicapées
- Portes à un/deux vantaux à ouverture vers l'intérieur et l'extérieur
- Dimensions de vantail de porte jusqu'à 1465 x 3000 mm et poids de vantail jusqu'à 230 kg

Emergency exit systems

- Closing system for emergency exit doors in accordance with EN 179
- Closing system for panic doors in accordance with EN 1125
- Barrier-free doors without threshold for accessible buildings
- Single and double-leaf doors, inward and outward opening
- Door leaf sizes up to 1465 x 3000 mm and leaf weight up to 230 kg



Jansen-Economy 60 Fingerschutzüren

- Keine Quetsch- und Scherstellen nach DIN 18650
- Wartungsarme Bandlager unten und oben
- Geeignet für Gebäude mit starkem Publikumsverkehr
- Geprüft nach EN 14351-1

Portes anti-pince-doigts Jansen-Economy 60

- Absence de zones d'écrasement et de cisaillement selon DIN 18650
- Paliers de paumelle inférieur et supérieur exigeant peu de maintenance
- Adapté à des bâtiments publics fortement fréquentés
- Contrôlé selon la norme EN 14351-1

Jansen Economy 60 anti-finger-trap doors

- No crushing and shearing points as per DIN 18650
- Low-maintenance hinge bush at top and bottom
- Suitable for buildings subject to frequent use by the public
- Tested in accordance with EN 14351-1



Verblechte Jansen-Economy 60 Türen

- Flächenbündig verblechte Türen
- Geschweisst oder geklebt
- Nach innen und aussen öffnend
- Mit Glasausschnitt möglich

Portes tôlées Jansen-Economy 60

- Portes tôlées à fleur
- Soudées ou collées
- Ouverture vers l'intérieur et l'extérieur
- Panneau de verre possible

Jansen Economy 60 sheet metal doors

- Flush-fitted sheet metal doors
- Welded or bonded
- Inward and outward-opening
- Can have glass vision panel



Jansen-Economy 60 Faltwand

- Nach innen und aussen öffnend
- Leichtgängige, geräuscharme Bedienung
- Schwellenlose Ausführung
- Flügelgewichte bis 100 kg

Porte repliable Jansen-Economy 60

- Ouverture vers l'intérieur et l'extérieur
- Mobilité silencieuse
- Exécution sans seuil
- Poids de vantail jusqu'à 100 kg

Jansen Economy 60 folding wall

- Inward and outward-opening
- Smooth and quiet operation
- Design without a threshold
- Vent weights up to 100 kg

Jansen Docu Center

Die Plattform zum effizienten Arbeiten mit Jansen Dokumentationen. Im Jansen Docu Center stehen alle Produktinformationen jederzeit digital in der aktuellsten Version zur Verfügung: von Architekten-Informationen über Bestell- und Fertigungskatalogen bis hin zu Anleitungen und Prospekten sowie Videos.

Die Inhalte können einfach und schnell aufgerufen werden. Ein für den Anwender komfortables papierloses Arbeiten, das zahlreiche Vorteile bietet.

Download CAD Daten

DXF

DWG

Sie können die Zeichnungen in den Formaten DXF und/oder DWG herunterladen. Klicken Sie auf das entsprechende Icon und der Download erfolgt.

Die Hinweise «Artikelbibliothek/Türbeschläge/Fensterbeschläge» bedeuten, dass Sie mit einem Klick die gesamte Artikelbibliothek des entsprechenden Systems herunterladen (Profile, Beschläge, Glasleisten, Zubehör etc.).

Info und Beratung

Gerne beraten wir Sie persönlich und stehen Ihnen bei Fragen zur Verfügung. Bitte schreiben Sie uns Ihre Anliegen an: info@jansen.com

Jansen Docu Center

La plate-forme pour travailler efficacement avec les documentations Jansen. Le Jansen Docu Center met à votre disposition les informations sur les produits, en format numérique et dans une version actualisée: des catalogues de commande et de fabrication aux instructions et prospectus, en passant par les informations destinées aux architectes et vidéos.

Les contenus sont facilement et rapidement accessibles. Une manière de travailler confortable et offrant de nombreux avantages.

Télécharger fichiers DAO

DXF

DWG

Vous pouvez télécharger les dessins aux formats DXF et/ou DWG. Cliquez sur l'icône correspondante et le téléchargement s'effectuera.

Les indications «Bibliothèque des articles/Ferures de porte/Ferrures de fenêtres» signifie que vous téléchargez la totalité de la bibliothèque des articles du système donné (profilés, ferrures, parclozes, accessoires etc.).

Info et conseils

Nous vous conseillerons volontiers individuellement et sommes à votre disposition si vous avez des questions à poser. Veuillez nous envoyer votre requête à: info@jansen.com

Jansen Docu Center

The platform for working efficiently with Jansen documentation. The latest version of all the product information is available digitally at any time in the Jansen Docu Center – from order and fabrication manuals to architect information, instructions and brochures and videos.

The content can be retrieved quickly and easily. The user can work conveniently without paper, which has numerous benefits.

Download CAD files

DXF

DWG

You can download the drawings in DXF and/or DWG format. Click on the relevant icon to begin the download.

The items «Article library/Door fittings/Window fittings» means that you download the entire article library for the corresponding system with one click (profiles, fittings, glazing beads, accessories etc.).

Information and advice

We would be delighted to provide you with advice in person and are available to answer any questions you may have. Please write to us with your queries at: info@jansen.com

Zulassungen/Prüfungen
Homologations/Essais
Authorisations/Tests

Jansen-Economy 60 Türen
Jansen-Economy 60 portes
Jansen-Economy 60 doors

Elementgrößen
(Empfehlung für CE-Kennzeichnung)

Dimensions des éléments
(Recommandation pour le label CE)

Size of elements
(Recommendation for CE marking)

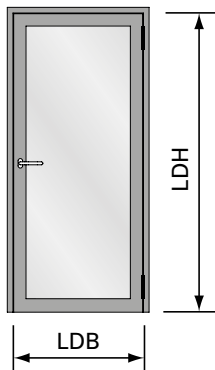

LDB Lichte Durchgangsbreite
max. 1400 mm
min. 490 mm

LDB Largeur vide lumière
max. 1400 mm
min. 490 mm

LDB Clear opening width
max. 1400 mm
min. 490 mm

LDH Lichte Durchgangshöhe
max. 3000 mm
min. 1900 mm

LDH Hauteur vide lumière
max. 3000 mm
min. 1900 mm

LDH Clear opening height
max. 3000 mm
min. 1900 mm

Flügelgewicht max. 230 kg

Poids de vantail max. 230 kg

Weight of leaf max. 230 kg

Zulassungen/Prüfungen
Homologations/Essais
Authorisations/Tests

Jansen-Economy 60 Türen
Jansen-Economy 60 portes
Jansen-Economy 60 doors

Elementgrößen
(Empfehlung für CE-Kennzeichnung)

Dimensions des éléments
(Recommandation pour le label CE)

Size of elements
(Recommendation for CE marking)

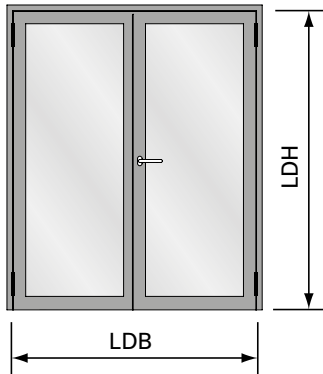

LDB Lichte Durchgangsbreite
max. 2800 mm
min. 1000 mm

LDB Largeur vide lumière
max. 2800 mm
min. 1200 mm

LDB Clear opening width
max. 2800 mm
min. 1000 mm

LDH Lichte Durchgangshöhe
max. 3000 mm
min. 1900 mm

LDH Hauteur vide lumière
max. 3000 mm
min. 1900 mm

LDH Clear opening height
max. 3000 mm
min. 1900 mm

Flügelgewicht max. 230 kg

Poids de vantail max. 230 kg

Weight of leaf max. 230 kg

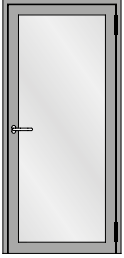

Einflügelige Türe
Porte à un vantail
Single leaf door

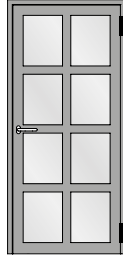

Einflügelige Türe mit Riegel
Porte à un vantail avec traverse
Single leaf door with transom

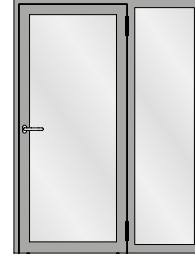

Einflügelige Türe mit Seitenteil
Porte à un vantail avec partie latérale
Single leaf door with side light

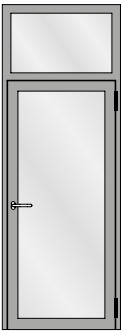

Einflügelige Türe mit Oberlicht
Porte à un vantail avec imposte
Single leaf door with top light

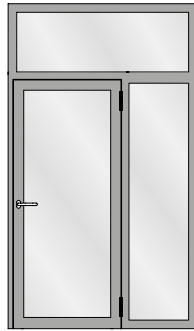

Einflügelige Türe mit Seitenteil und Oberlicht
Porte à un vantail avec avec partie latérale
et imposte
Single leaf door with side light and top light

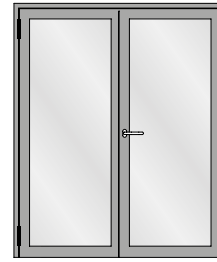

Zweiflügelige Türe
Porte à deux vantaux
Double leaf door



Zweiflügelige Türe mit zwei Seitenteilen
Porte à deux vantaux avec deux parties latérales
Double leaf door with two side lights

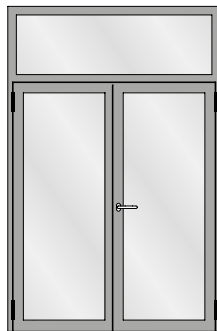

Zweiflügelige Türe mit Oberlicht
Porte à deux vantaux avec imposte
Double leaf door with top light

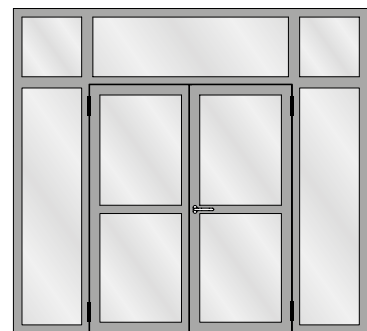

Zweiflügelige Türe mit zwei Seitenteilen und
Oberlichtern
Porte à deux vantaux avec deux parties
latérales et impostes
Double leaf door with two side lights and
top lights

Typenübersicht
Sommaire des types
Summary of types

Jansen-Economy 60 Türen
Jansen-Economy 60 portes
Jansen-Economy 60 doors

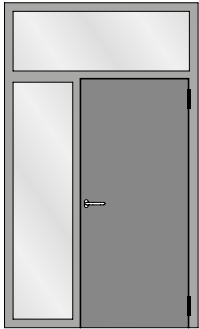

Verblechte Türe mit Seitenteil und Oberlicht
Porte tôlée à un vantail avec avec partie latérale
et imposte
Sheet metal single leaf door with side light
and top light



Verblechte zweiflügelige Türe mit zwei
Seitenteilen und Oberlichtern
Porte tôlée à deux vantaux avec deux parties
latérales et impostes
Sheet metal double leaf door with two side
lights and top lights



Festverglasung
Vitrage fixe
Fixed glazing

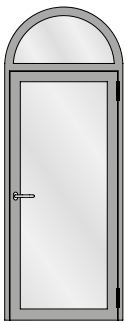

Einflügelige Türe mit Rundbogen-Oberlicht
Porte à un vantail avec imposte demi-ronde
Single leaf door with round arched top light

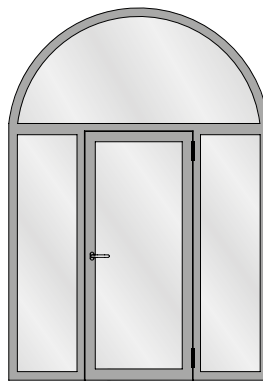

Einflügelige Türe mit zwei Seitenteilen und
Rundbogen-Oberlicht
Porte à un vantail avec deux parties latérales
et imposte demi-ronde
Single leaf door with two side lights and
round arched top light

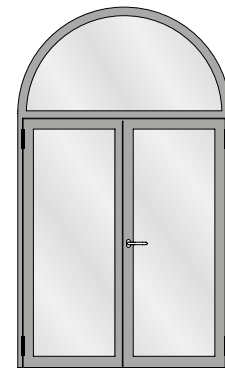

Zweiflügelige Türe mit Rundbogen-Oberlicht
Porte à deux vantaux avec imposte demi-ronde
Double leaf door with round arched top light

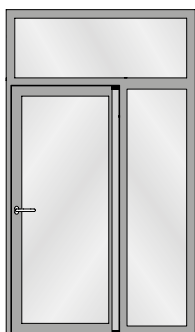

Fingerschutztüre
Porte anti-pince-doigts
Anti-finger-trap door

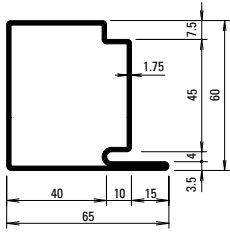

30.019
30.019 Z

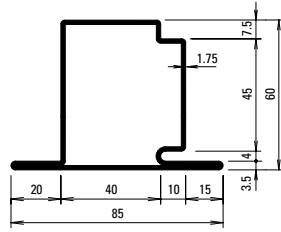

30.119
30.119 Z

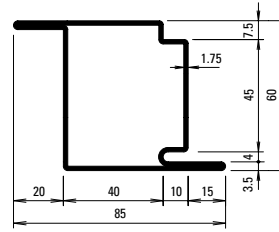

30.419
30.419 Z

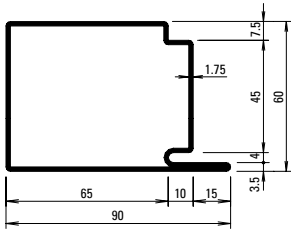

30.017
30.017 Z

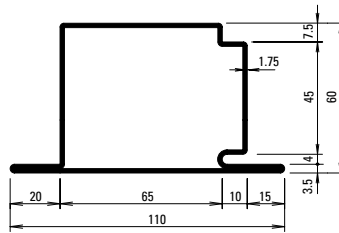

30.117
30.117 Z

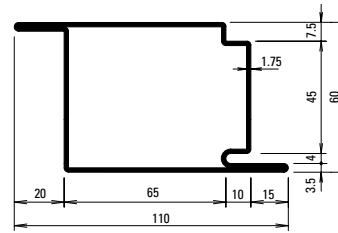

30.415

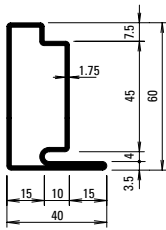

30.018
30.018 Z

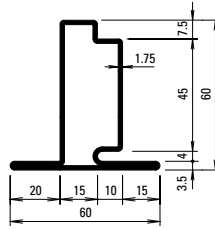

30.118
30.118 Z

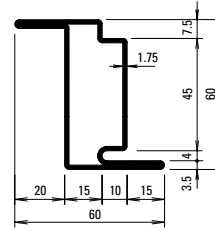

30.418
30.418 Z

Oberfläche/Werkstoff

Artikel-Nr.

ohne Zusatz = blank

mit Z = bandverzinkter Stahl

Surface/Matériau

No. d'article

sans supplément = brut

avec Z = bande d'acier zinguée

Surface/Material

Part no.

without addition = bright

with Z = strip galvanised steel

Profil-Nr.	G kg/m	F cm ²	I _x cm ⁴	W _x cm ³	I _y cm ⁴	W _y cm ³	U m ² /m
30.017	4,200	5,36	31,32	9,09	48,57	10,35	0,312
30.018	2,830	3,61	15,95	4,35	4,77	1,93	0,212
30.019	3,520	4,48	23,69	6,70	19,75	5,55	0,262
30.117	4,750	6,04	34,75	9,35	65,74	11,51	0,350
30.118	3,370	4,29	18,64	4,65	8,26	2,75	0,250
30.119	4,050	5,16	26,80	6,99	29,12	6,58	0,300

Profil-Nr.	G kg/m	F cm ²	I _x cm ⁴	W _x cm ³	I _y cm ⁴	W _y cm ³	U m ² /m
30.415	4,750	6,04	37,79	12,28	65,74	11,51	0,350
30.418	3,370	4,29	22,92	7,37	8,62	2,75	0,250
30.419	4,050	5,16	30,36	9,82	29,12	6,58	0,300

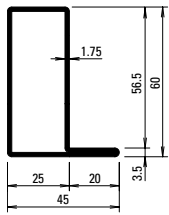

01.634
01.634 Z

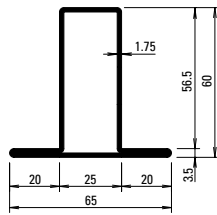

02.634
02.634 Z

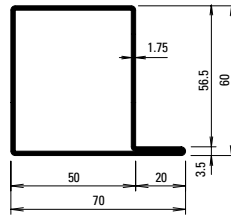

01.684
01.684 Z

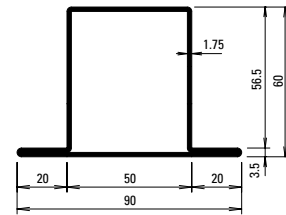

02.684
02.684 Z

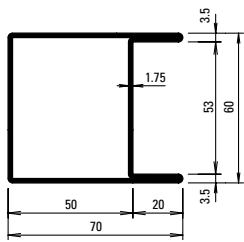

04.637
04.637 Z

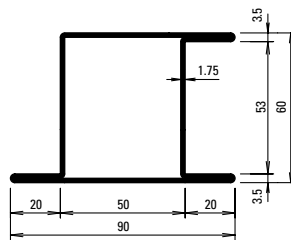

05.637
05.637 Z

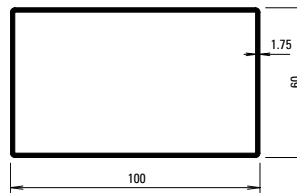

400.051
400.051 Z

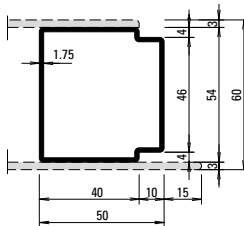

81.010 Z

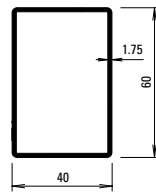

400.052
400.052 Z

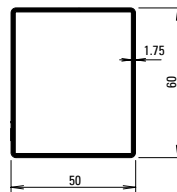

400.054
400.054 Z

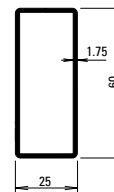

400.055
400.055 Z

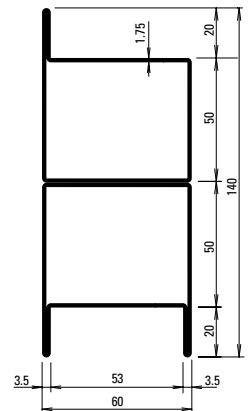

05.001

Profil-Nr.	G kg/m	F cm ²	I _x cm ⁴	W _x cm ³	I _y cm ⁴	W _y cm ³	U m ² /m
01.634	2,730	3,48	16,71	4,71	6,04	2,15	0,204
02.634	3,270	4,17	19,66	5,01	10,34	3,18	0,243
01.684	3,430	4,37	24,34	7,07	22,12	5,59	0,255
02.684	3,960	5,05	27,70	7,36	31,93	7,09	0,294
04.637	3,960	5,05	30,62	10,2	27,45	7,71	0,294
05.637	4,500	5,72	35,42	10,6	39,45	8,02	0,333
81.010	2,700	3,43	14,53	5,38	13,05	5,10	0,202
400.051	4,300	5,44	76,01	15,2	34,64	11,55	0,316
400.052	2,630	3,34	8,98	4,49	16,86	5,62	0,197
400.054	2,900	3,69	14,97	5,98	19,83	6,61	0,217
400.055	2,210	2,82	3,08	2,47	12,41	4,13	0,167

Stabachse
Axe de la barre
Bar axis

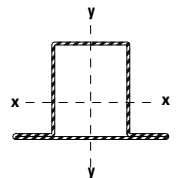

Artikelbibliothek
 Bibliothèque des articles
 Article library

DXF **DWG**

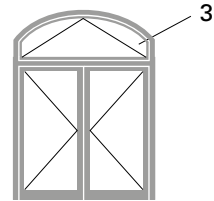
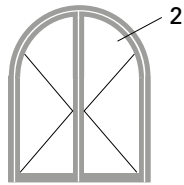
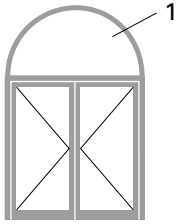

1.0

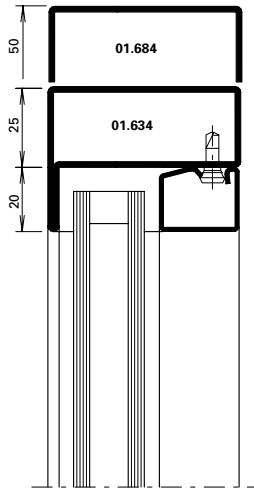

2.0

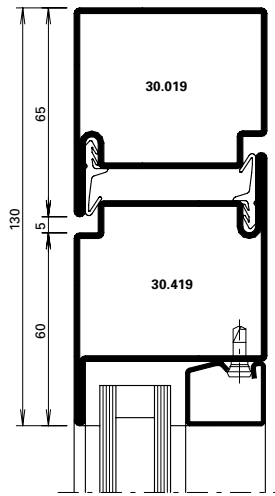

3.0

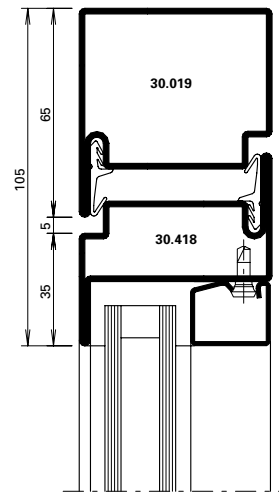

Halbrundbogen
 Arc semi-circulaire
 Semi-circular arch

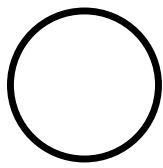

Rundbogen
 Arc en plein centre
 Round arch

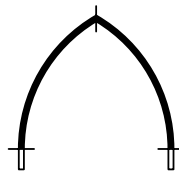

Spitzbogen
 Ogive
 Gothic arch



Stichbogen
 Arc bombé
 Segmented arch



Korbbogen
 Anse de panier
 Oval arch

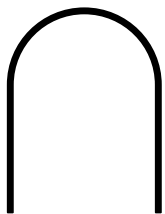

Halbrundbogen mit Schenkel
 Arc surhaussé
 Semi-circular arch with side extension

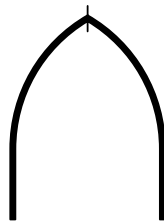

Spitzbogen mit Schenkel
 Arc en ogive
 Gothic arch with side extension

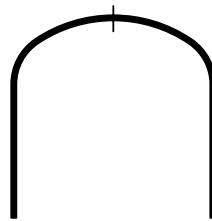



Korbbogen mit Schenkel
 Anse de panier prolongée
 Oval arch with side extension

Bogentüren
Portes cintrées
Arched doors

Jansen-Economy 60 Türen
 Jansen-Economy 60 portes
 Jansen-Economy 60 doors

Profil Profilé Profile	Min. Radius Rayon min. Min. radius R	
------------------------------	---	--

	blank brut bright	verzinkt zinguée galvanised
	mm	mm
01.634	550	550
01.684	650	650

	blank brut bright	verzinkt zinguée galvanised
	mm	mm
02.634	600	650
02.684	1050	1050

	blank brut bright	verzinkt zinguée galvanised
	mm	mm
04.637	1550	1550

	blank brut bright	verzinkt zinguée galvanised
	mm	mm
05.637	1550	1550

	blank brut bright	verzinkt zinguée galvanised
	mm	mm
400.052	1100	1100
400.054	1000	1000
400.055	800	800
81.010		800

Profil Profilé Profile	Min. Radius Rayon min. Min. radius R	
------------------------------	---	--

	blank brut bright	verzinkt zinguée galvanised
	mm	mm
30.018		550
30.019	650	650

	blank brut bright	verzinkt zinguée galvanised
	mm	mm
30.118	800	800
30.119	900	900

	blank brut bright	verzinkt zinguée galvanised
	mm	mm
30.418	800	800
30.419	1100	1100

Stahl-Glasleisten Parcloses en acier Steel glazing beads	Min. Radius Rayon min. Min. radius R
--	---

	
62.507 Z	300 mm
62.508 Z	300 mm
62.509 Z	300 mm

Stahl-Glasleisten Parcloses en acier Steel glazing beads	Min. Radius Rayon min. Min. radius R
--	---

	
402.112 Z	500 mm
402.115 Z	500 mm
402.120 Z	600 mm
402.125 Z	750 mm
402.130 Z	1000 mm
402.135 Z	1500 mm

Aluminium-Glasleisten Parcloses en aluminium Aluminium glazing beads	Min. Radius Rayon min. Min. radius R
--	---

	
404.109	400 mm
404.112	400 mm
404.115	400 mm
404.120	400 mm
404.125	450 mm
404.130	500 mm
404.135	600 mm

	
405.110	500 mm
405.115	500 mm
405.120	500 mm
405.125	800 mm
405.130	1000 mm
406.903	500 mm
406.905	500 mm
406.907	500 mm
406.909	600 mm

Die Radien-Angaben beziehen sich auf die langjährige Erfahrung und Fertigung im Hause Jansen.

Les rayons indiqués se fondent sur la longue expérience et la fabrication au sein de la maison Jansen.

The radii specifications are based on the many years of experience Jansen has in fabrication.

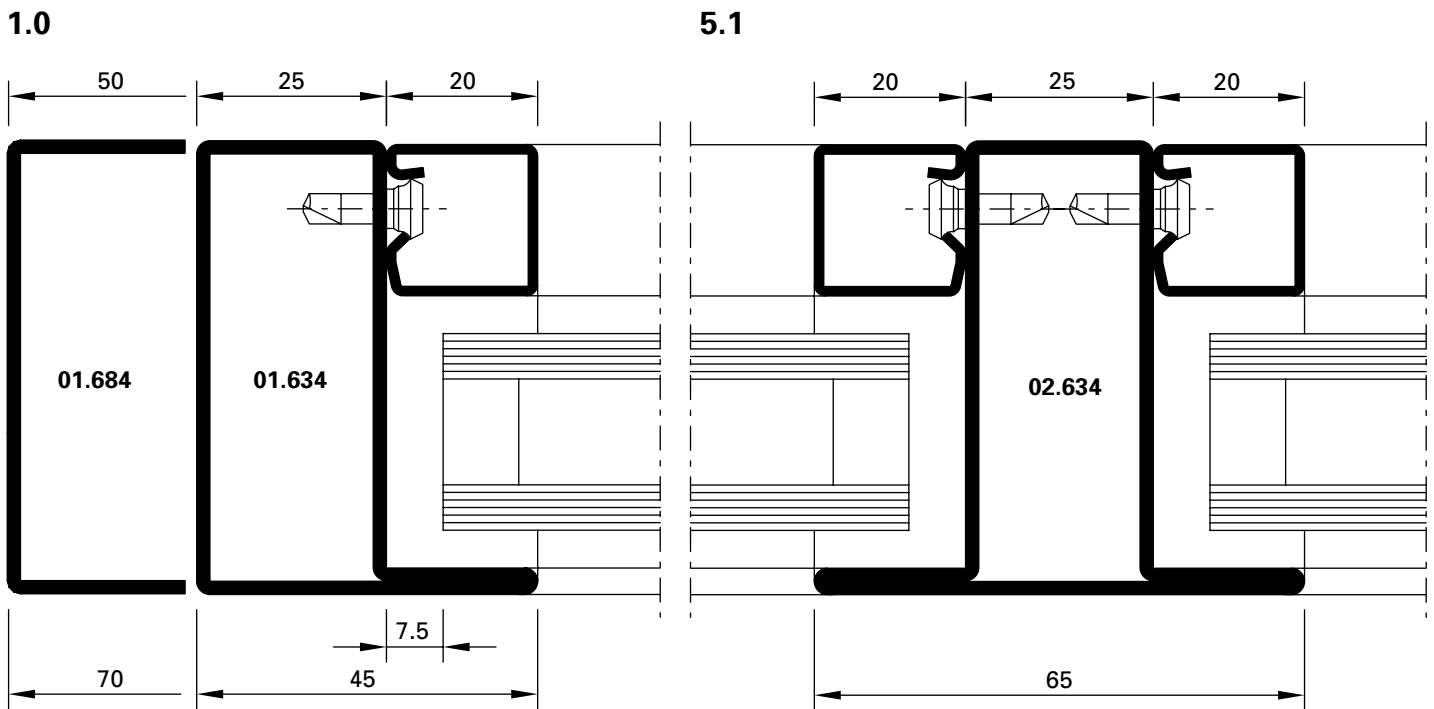
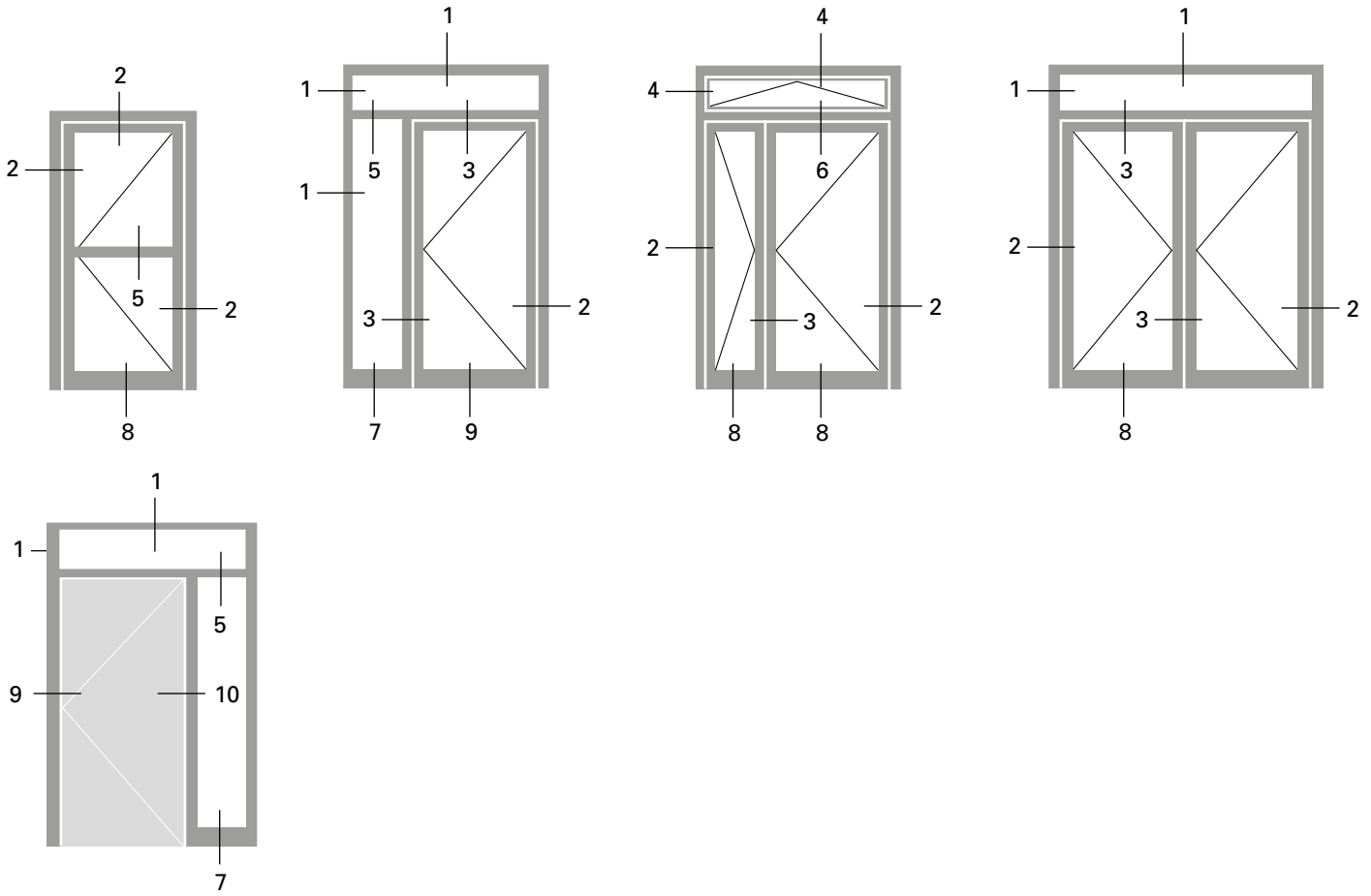

DXF **DWG** D-250-C-001

DXF **DWG** D-250-C-032

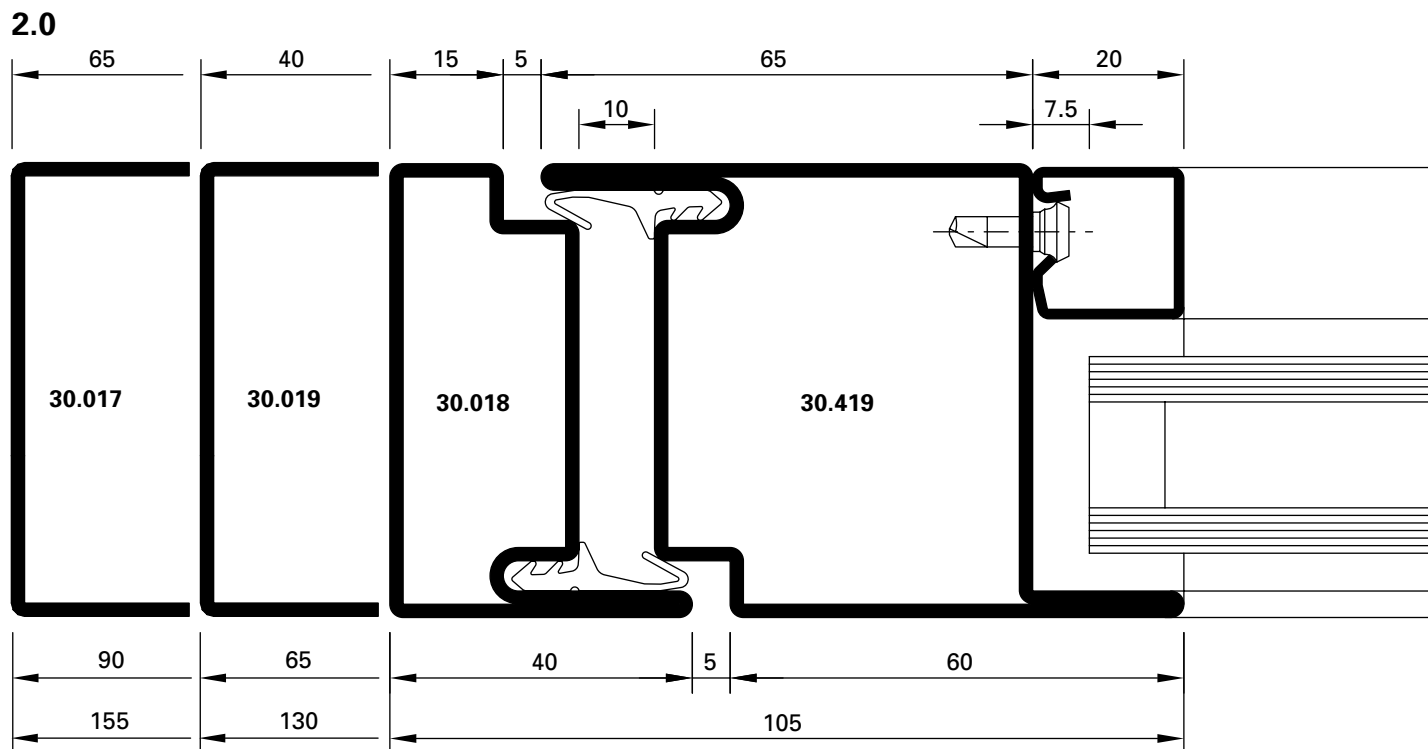

DXF DWG D-250-C-002

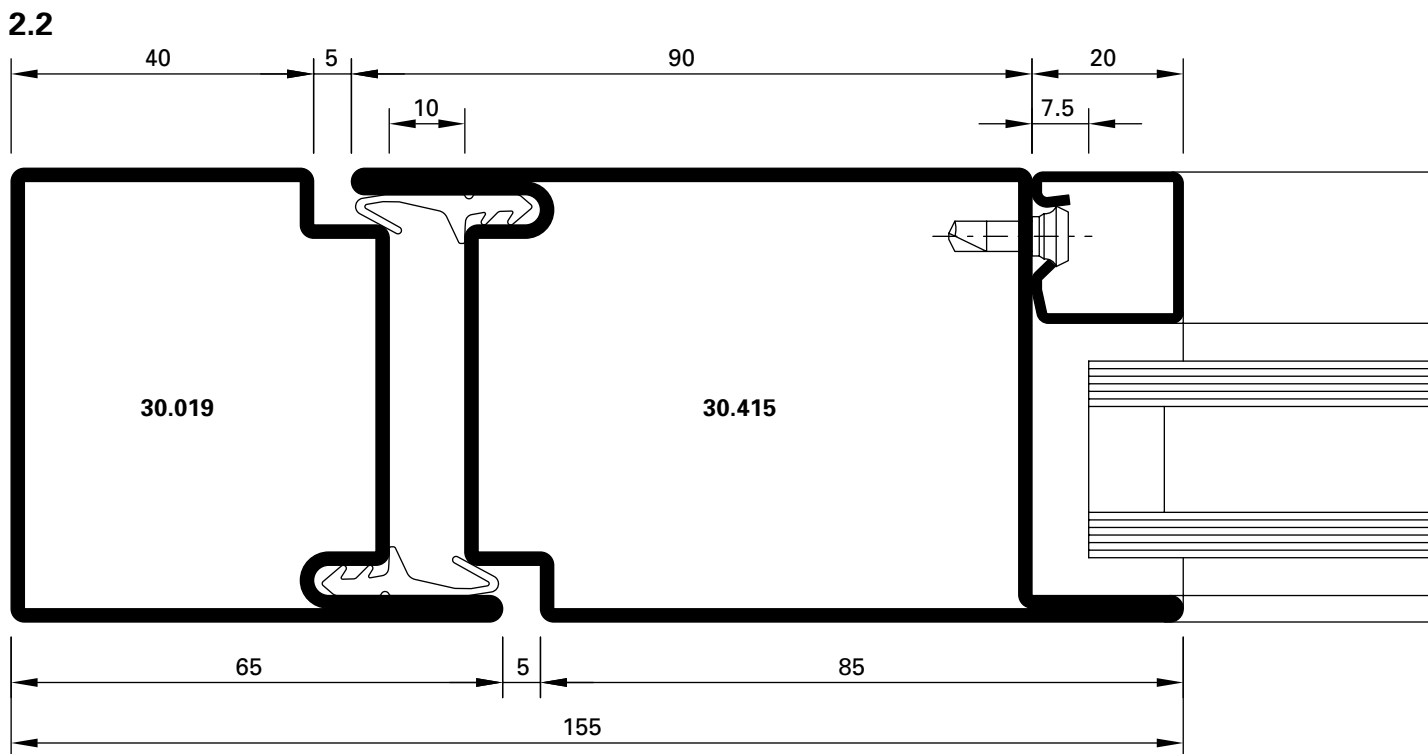

DXF DWG D-250-C-005

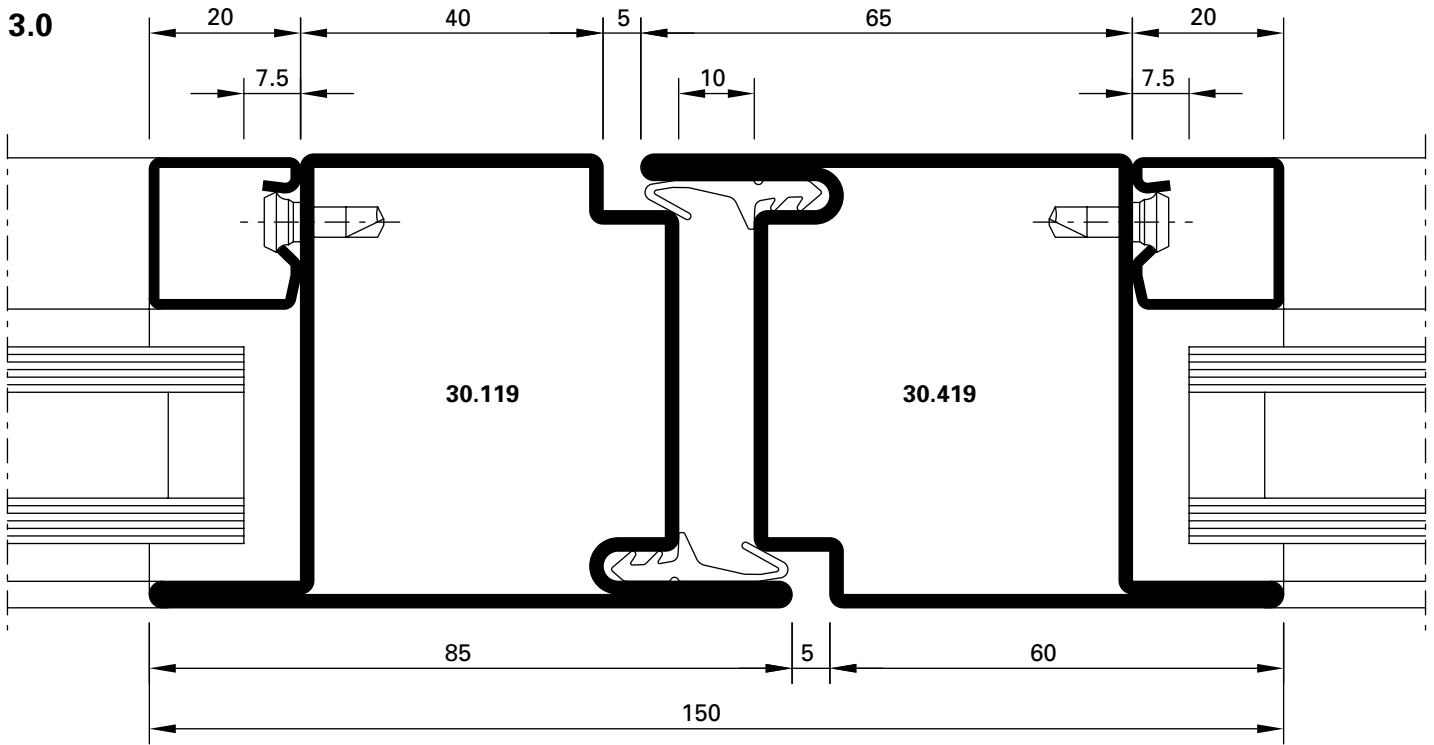

DXF DWG D-250-C-003

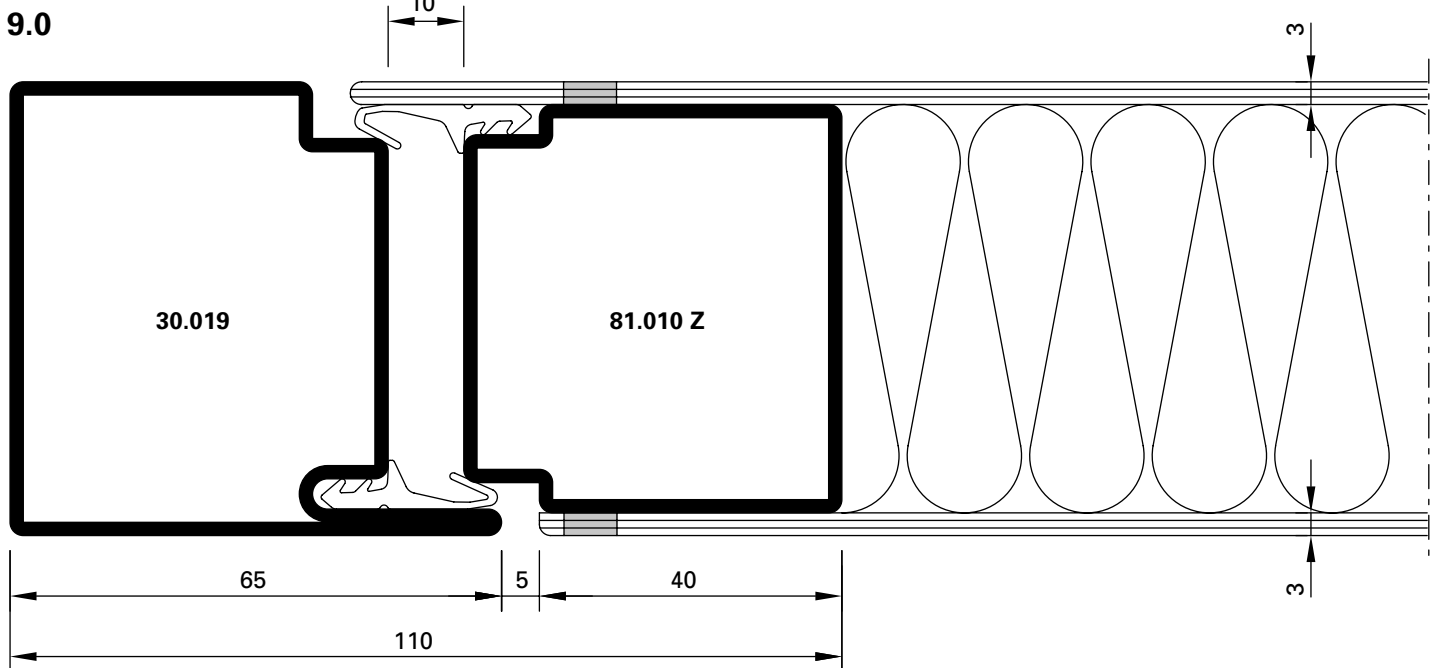

DXF DWG D-250-C-013

4.0

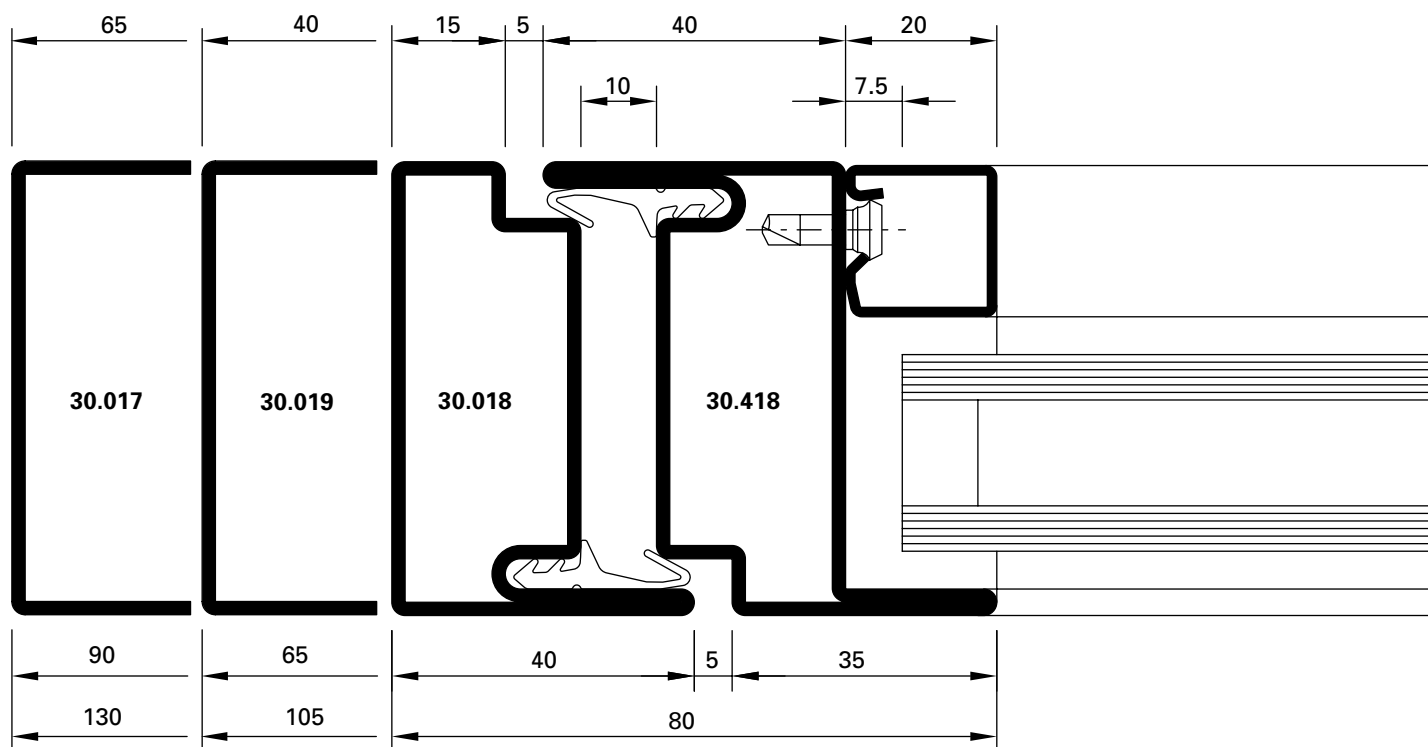

DXF **DWG** D-250-C-010

5.0

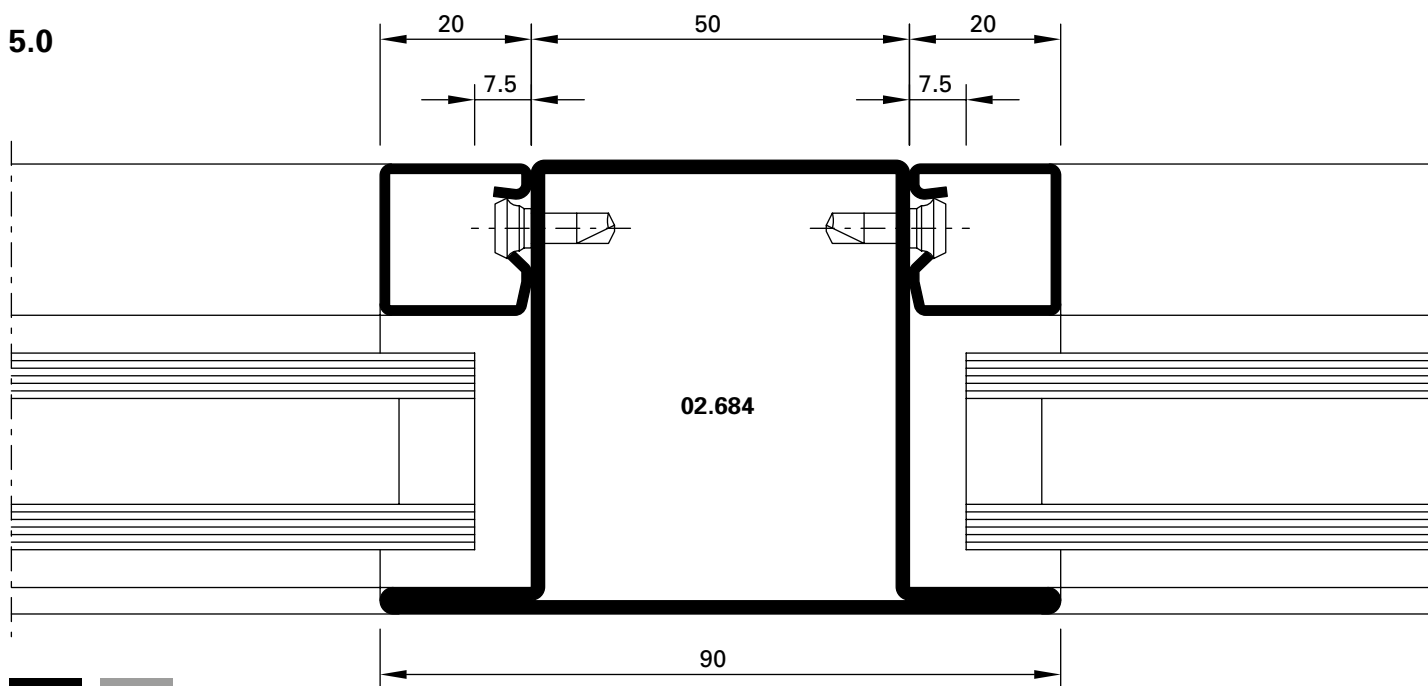

DXF **DWG** D-250-C-012

8.0

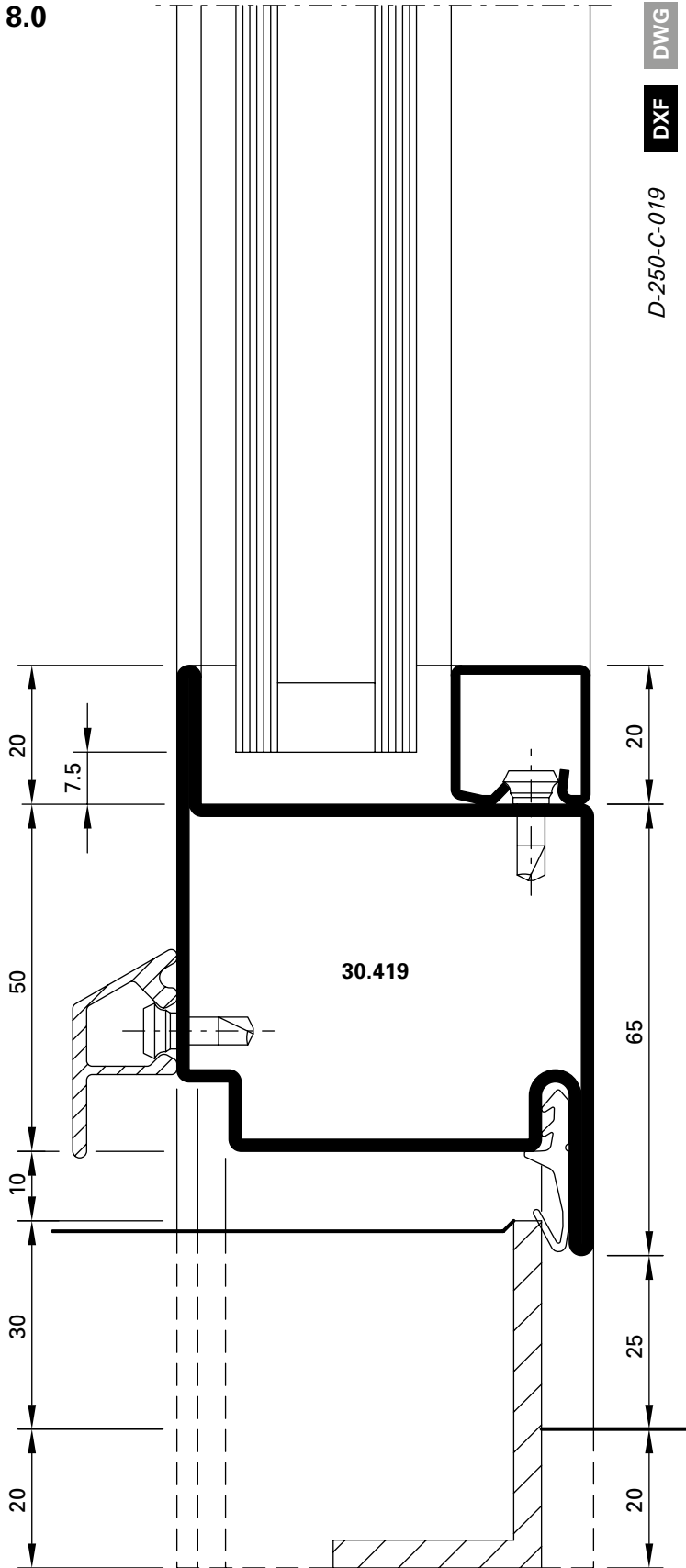

8.1

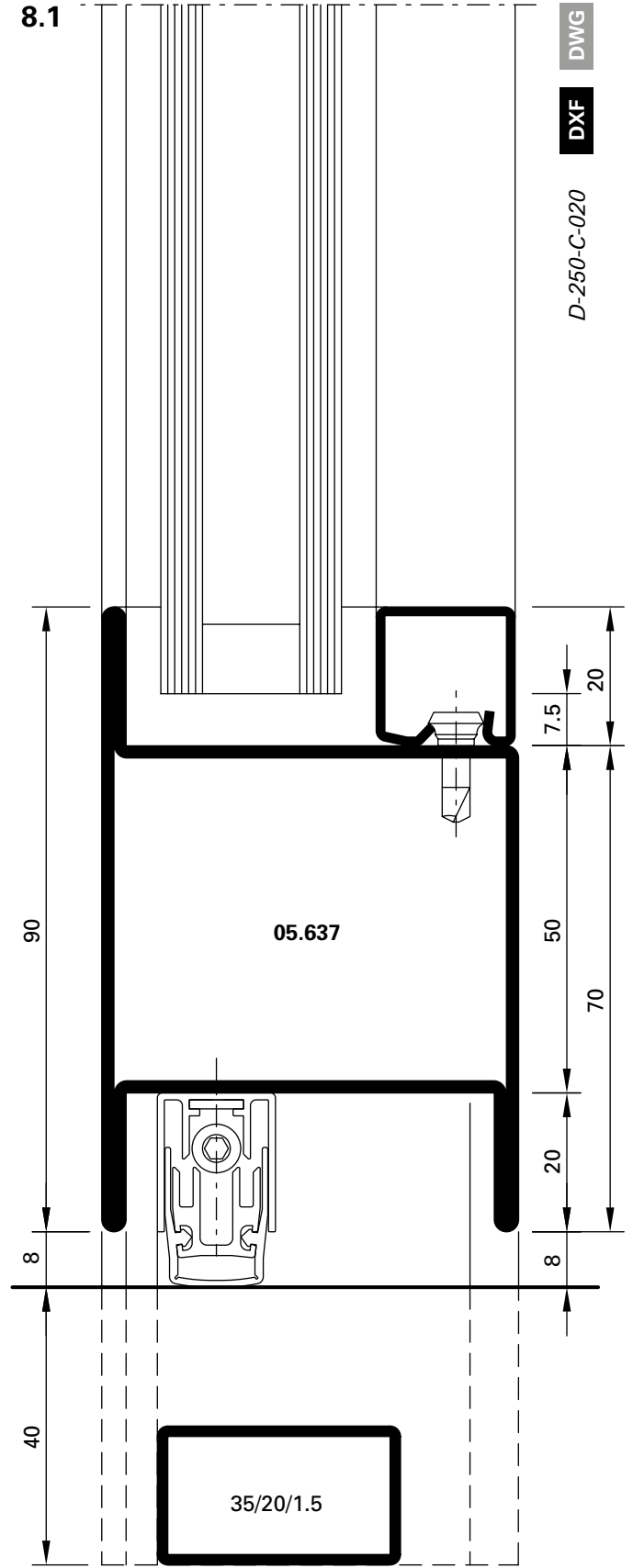

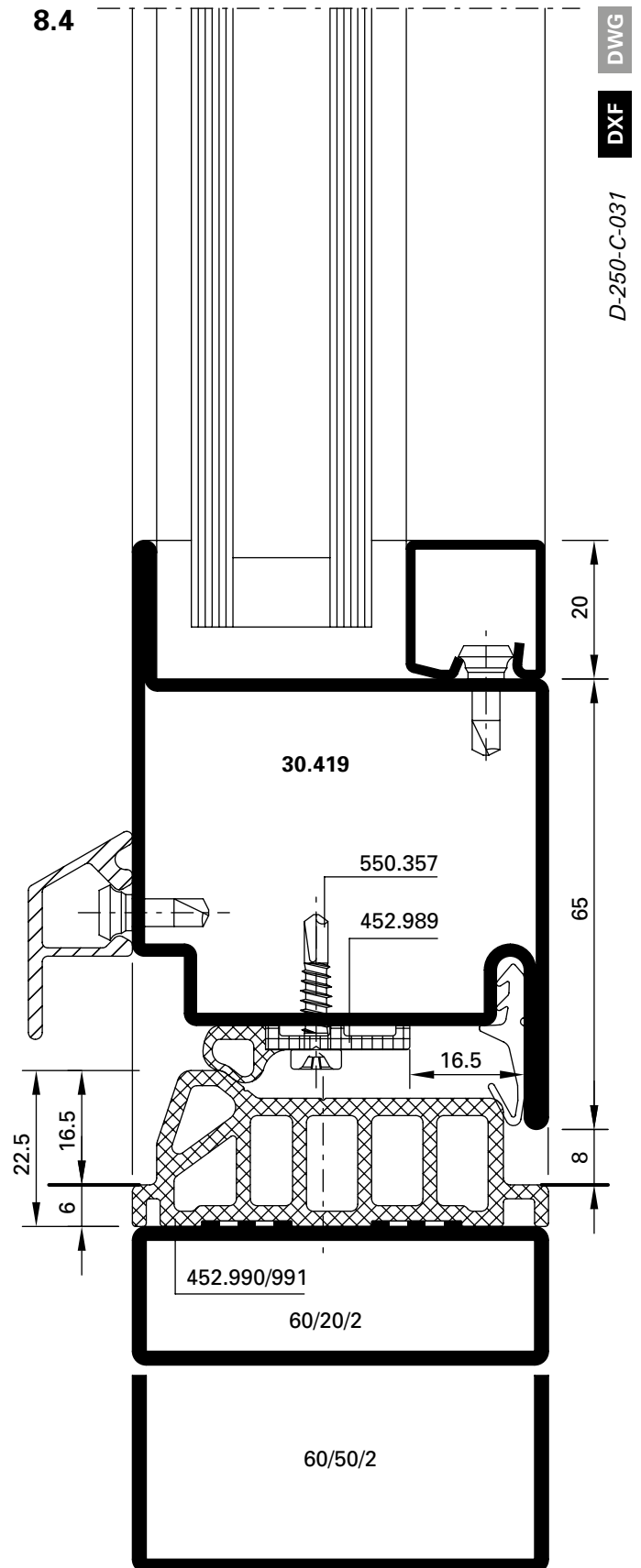
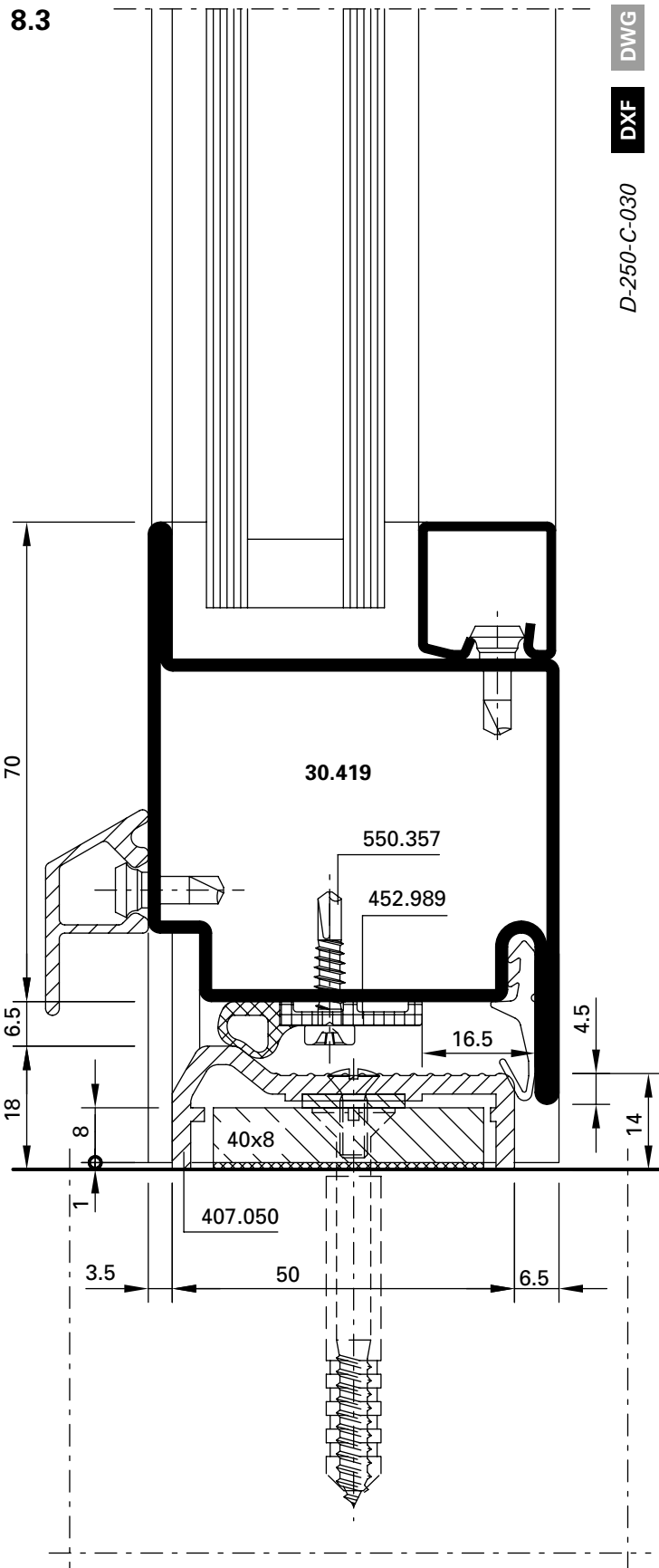

2.1

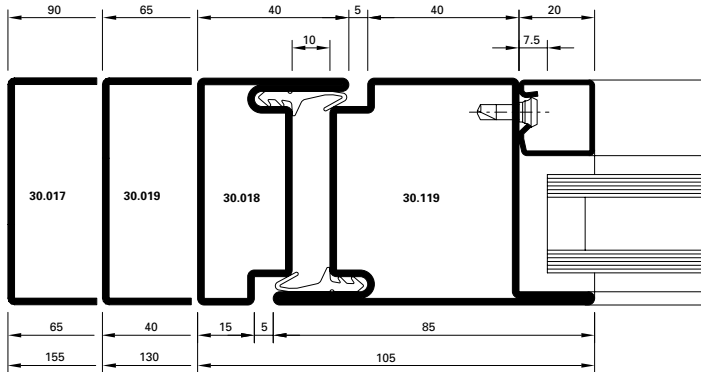

DXF **DWG** *D-250-C-004*

2.3

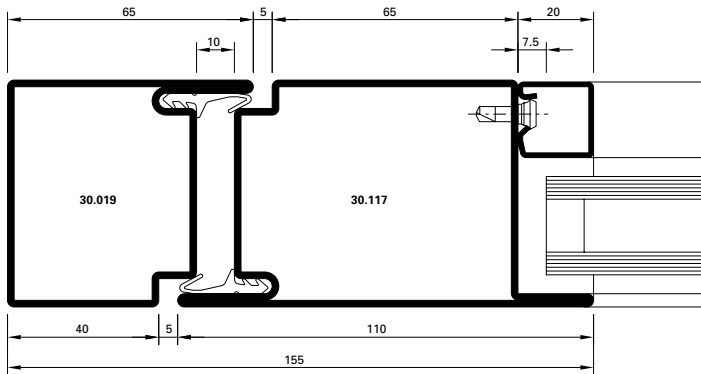

DXF **DWG** *D-250-C-006*

3.1

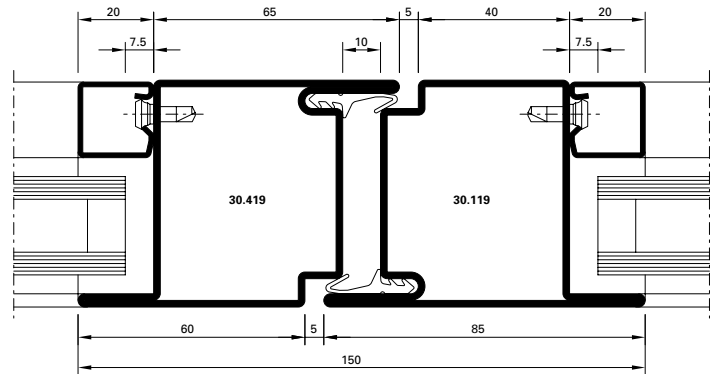

DXF **DWG** *D-250-C-007*

3.2

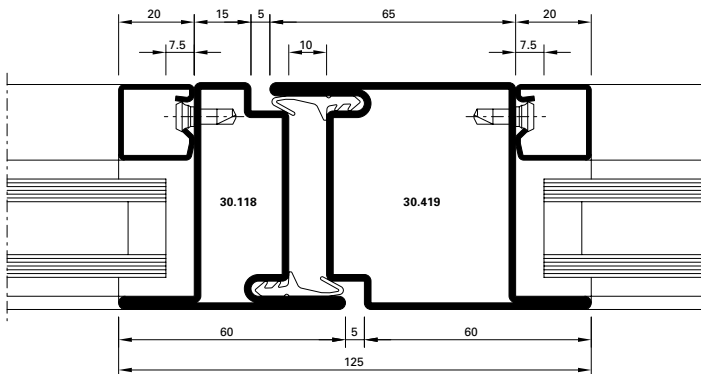

DXF **DWG** *D-250-C-008*

3.3

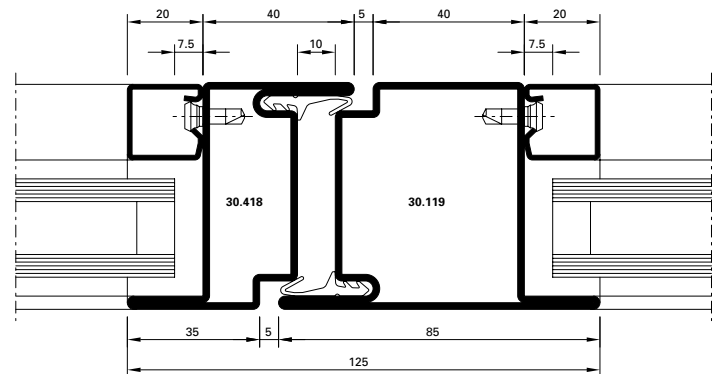

DXF **DWG** *D-250-C-009*

9.1

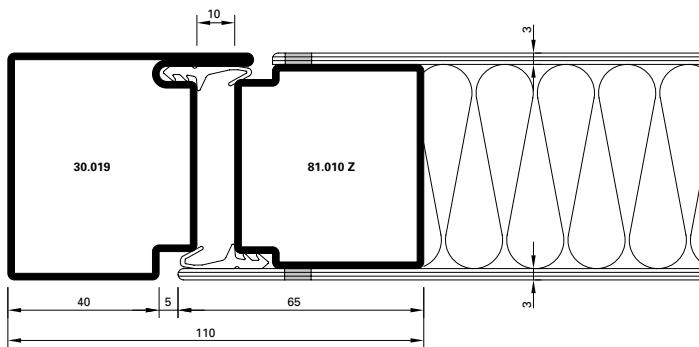

DXF **DWG** D-250-C-014

10.0

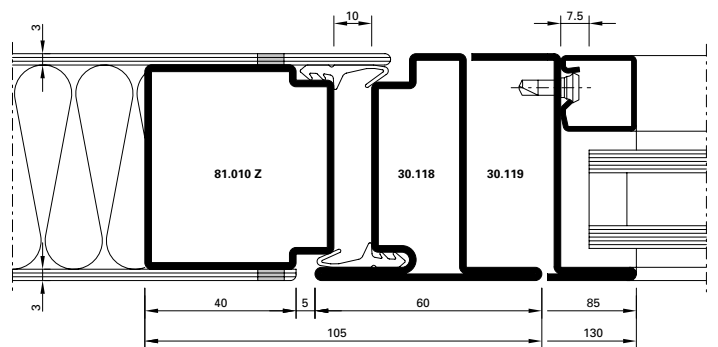

DXF **DWG** D-250-C-015

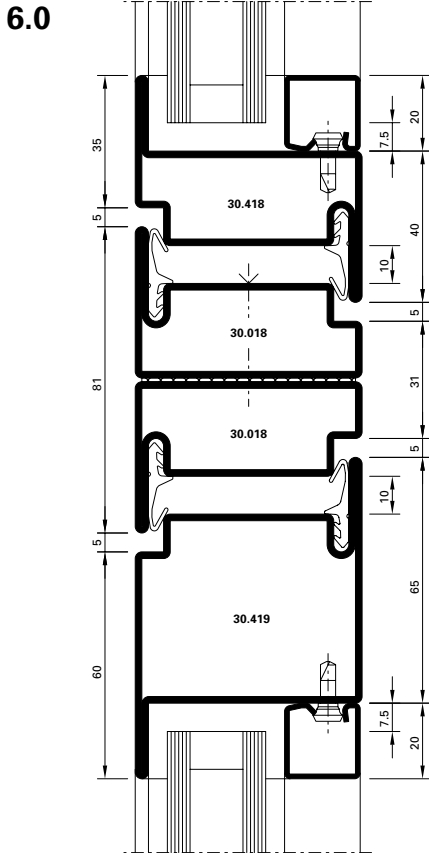

DWG
 DXF
 D-250-C-016

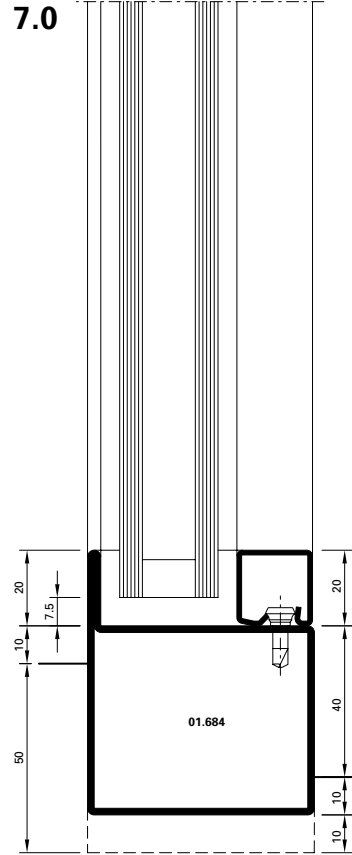

DWG
 DXF
 D-250-C-017

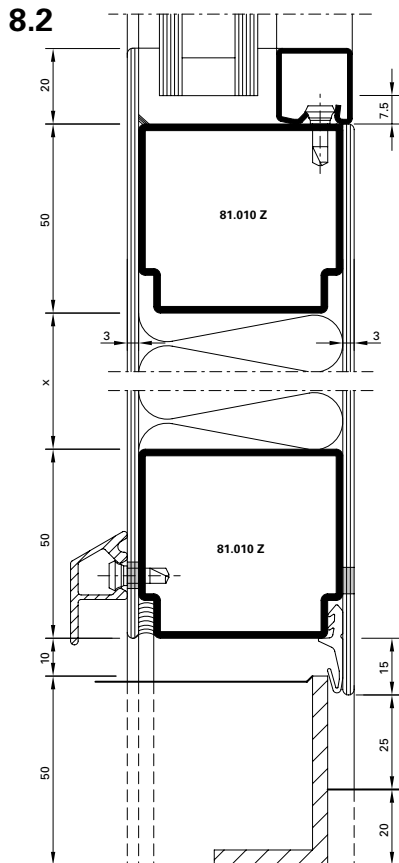

DWG
 DXF
 D-250-C-021

5.1

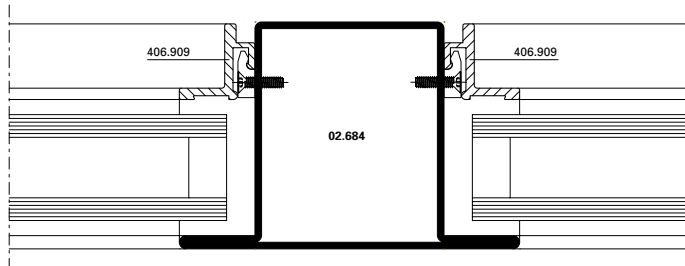

DXF **DWG** *D-250-C-022*

5.2

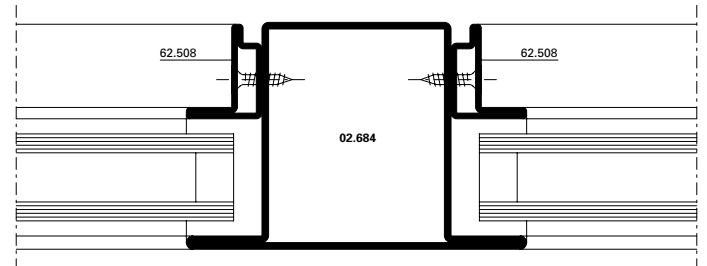

DXF **DWG** *D-250-C-023*

5.3

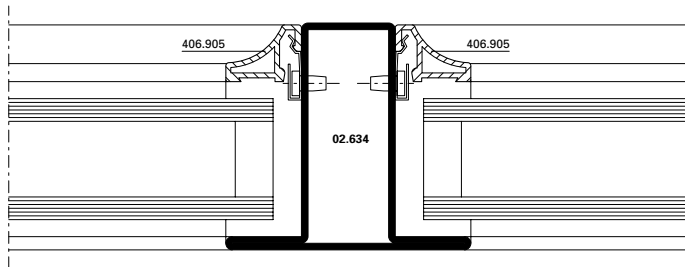

DXF **DWG** *D-250-C-024*

5.4

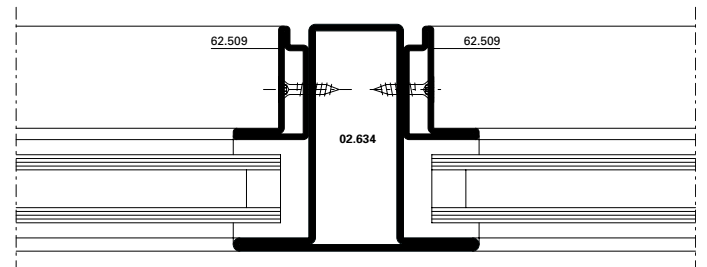

DXF **DWG** *D-250-C-025*

5.5

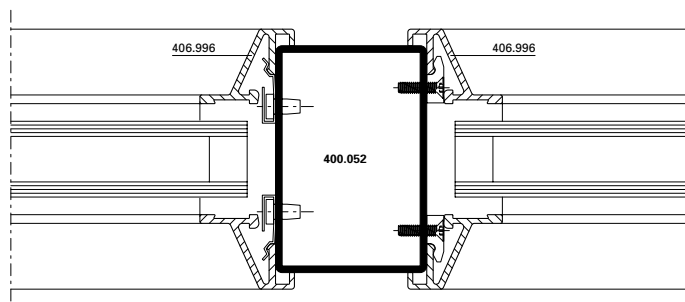

DXF **DWG** *D-250-C-026*

5.6

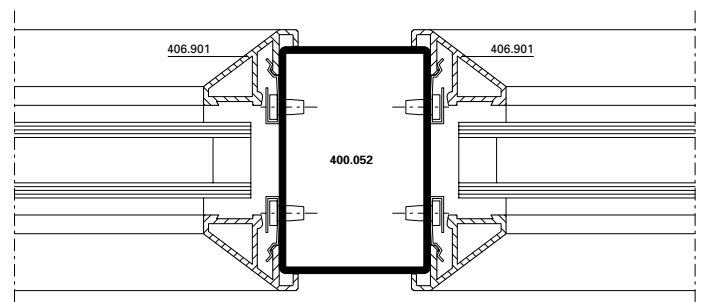

DXF **DWG** *D-250-C-027*

5.7

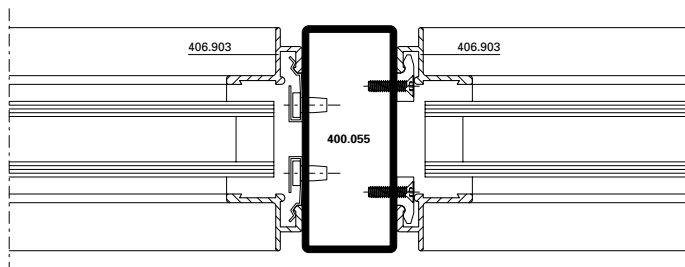

DXF **DWG** *D-250-C-028*

5.8

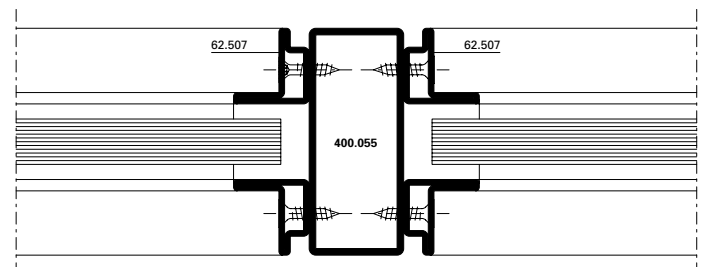

DXF **DWG** *D-250-C-029*

Schnittpunkte im Massstab 1:1
Coupe de détails à l'échelle 1:1
Section details on scale 1:1

Jansen-Economy 60 Türen
Jansen-Economy 60 portes
Jansen-Economy 60 doors

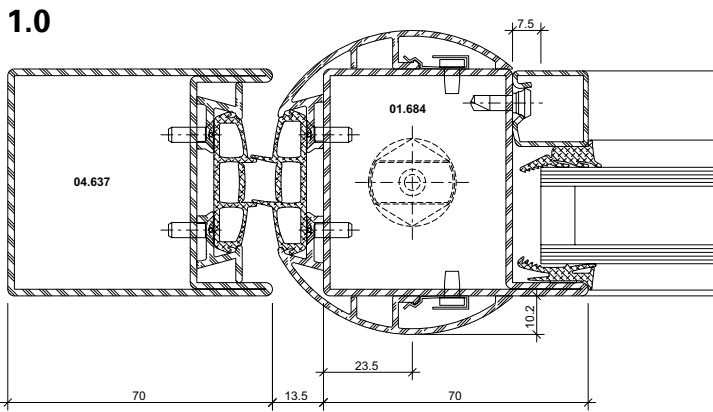
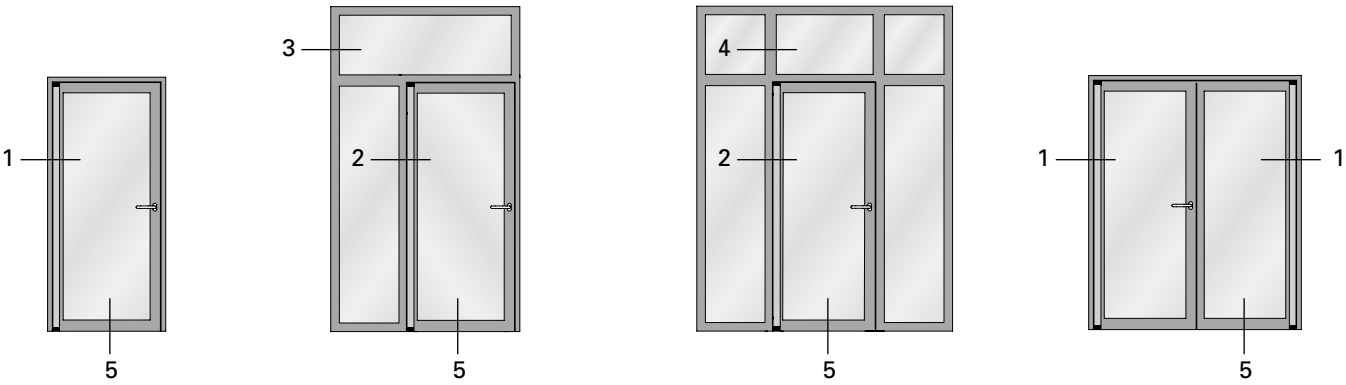

DXF **DWG** 22-0103-C-001

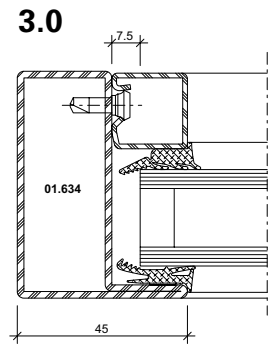

22-0101-C-001

DXF **DWG**

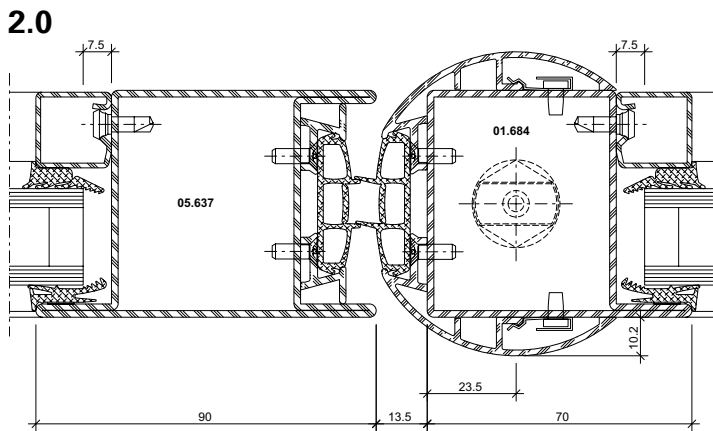

DXF **DWG** 22-0103-C-002

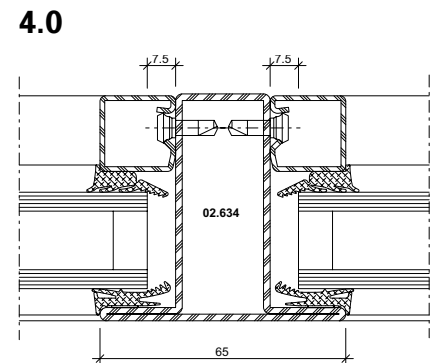

22-0101-C-002

DXF **DWG**

5.0

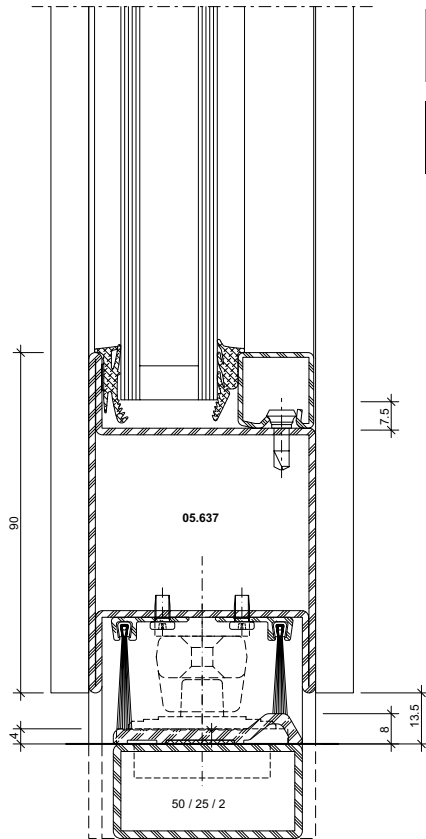

DWG

DXF

22-0103-C-003

5.1

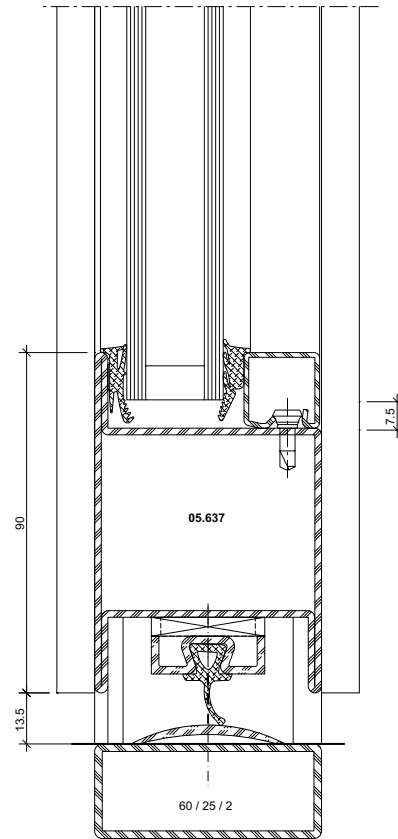

DWG

DXF

22-0103-C-009

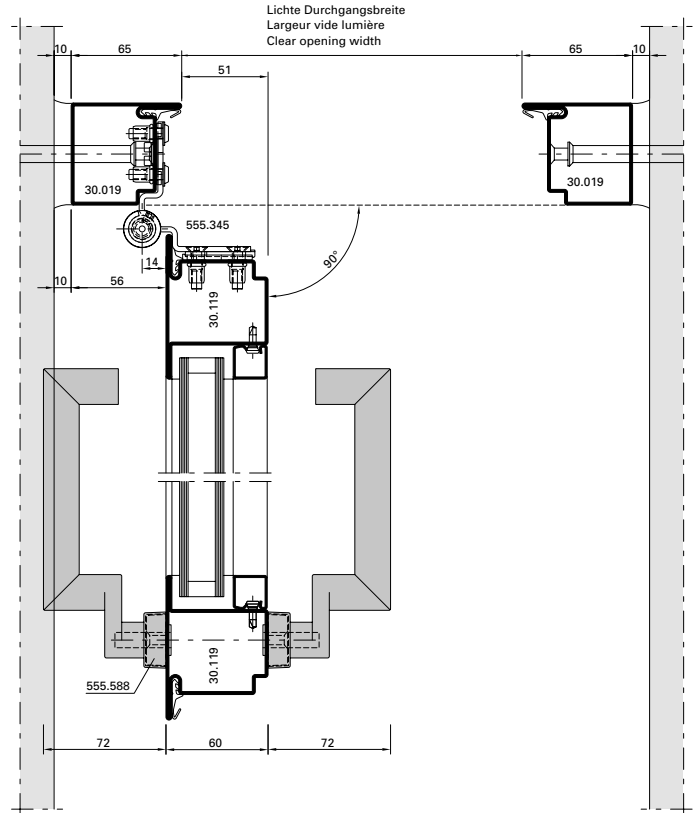
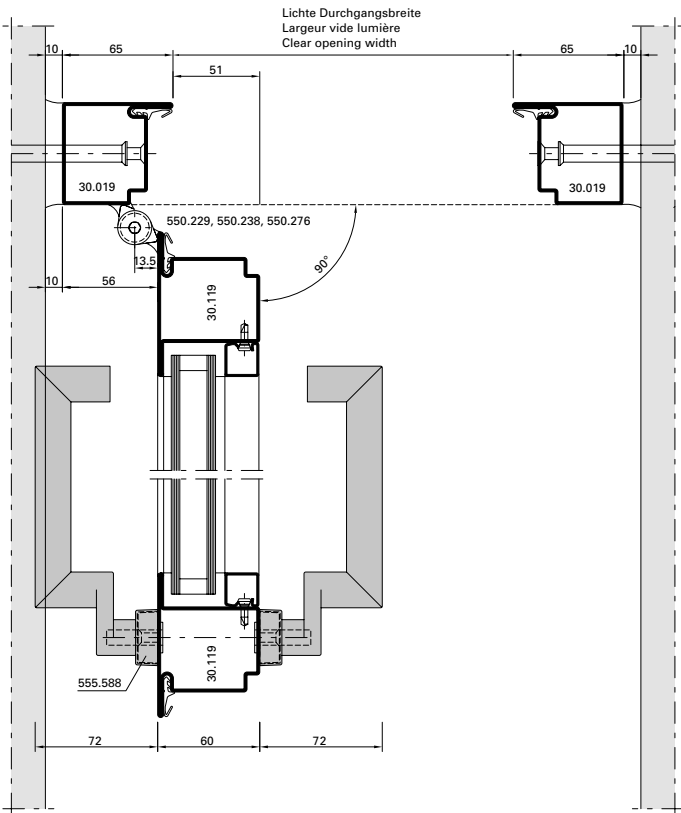

DXF **DWG** *D-250-E-016*

DXF **DWG** *D-250-E-018*

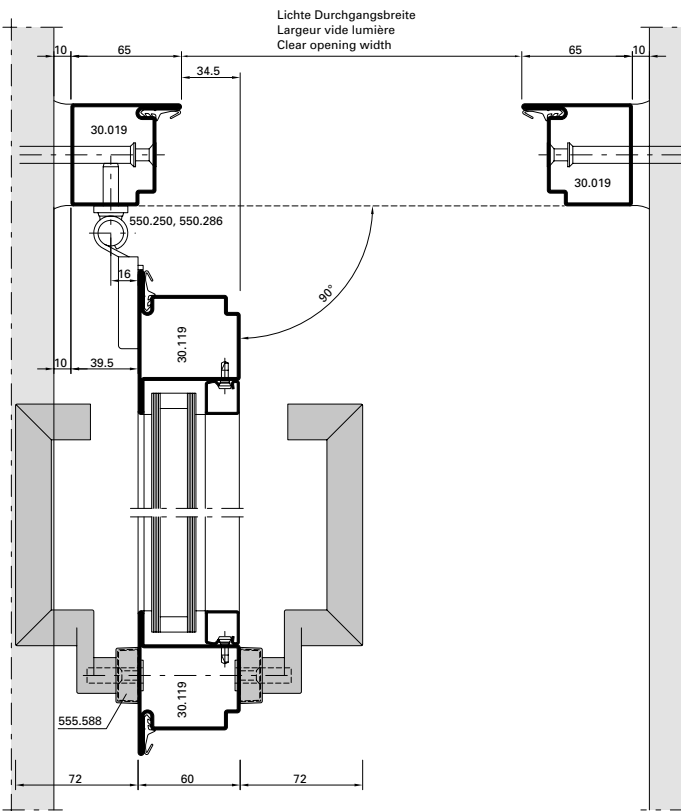

DXF **DWG** *D-250-E-020*

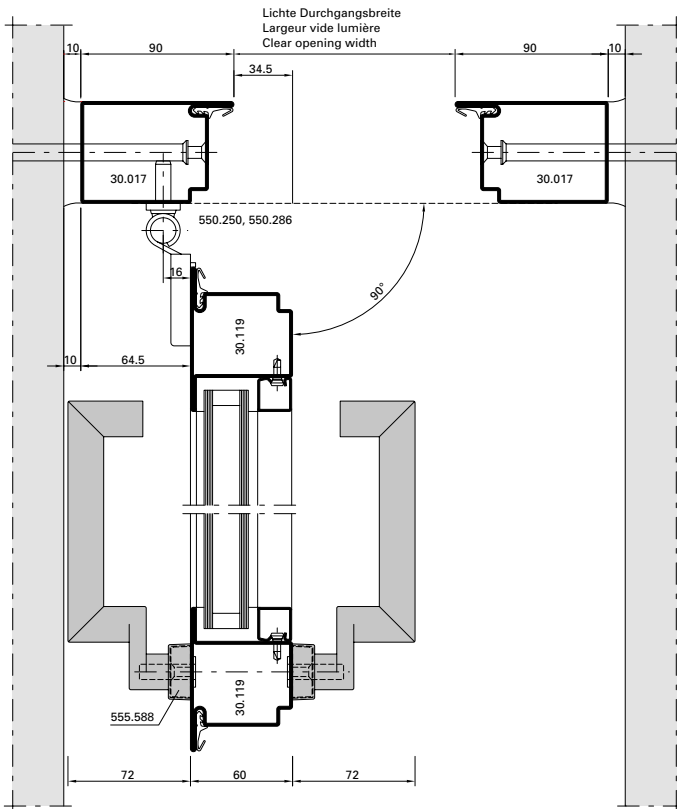

DXF **DWG** *D-250-E-021*

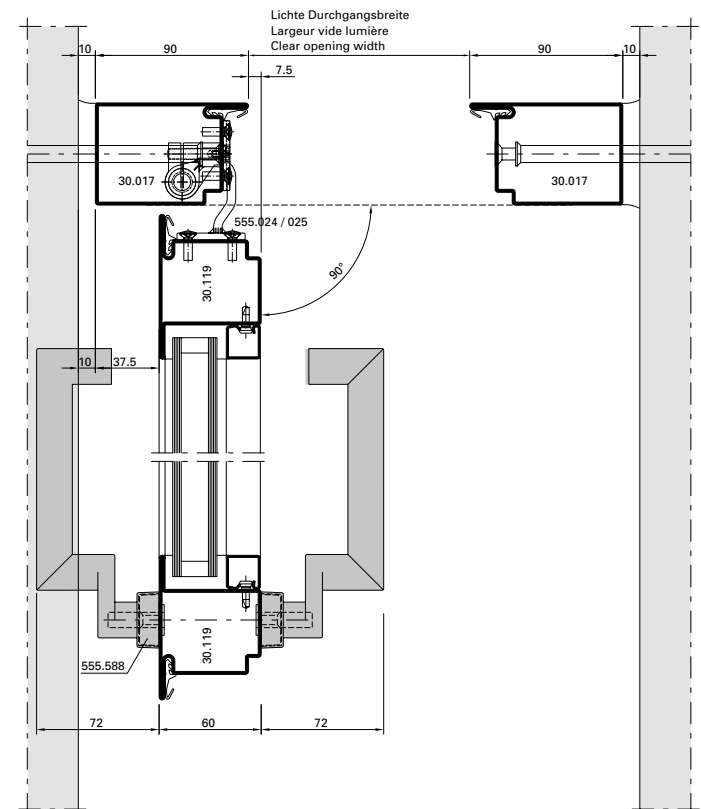

DXF **DWG** *D-250-E-025*

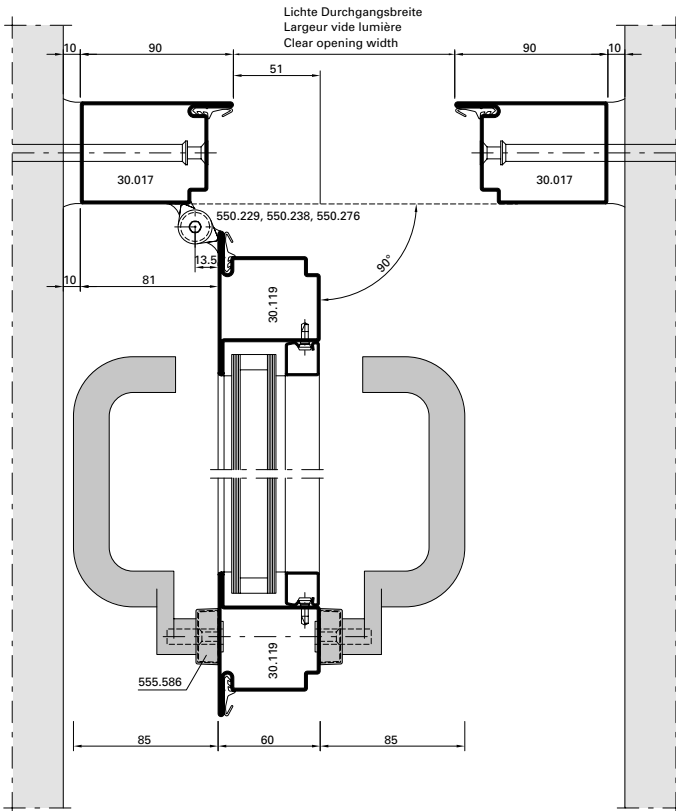

DXF **DWG** *D-250-E-017*

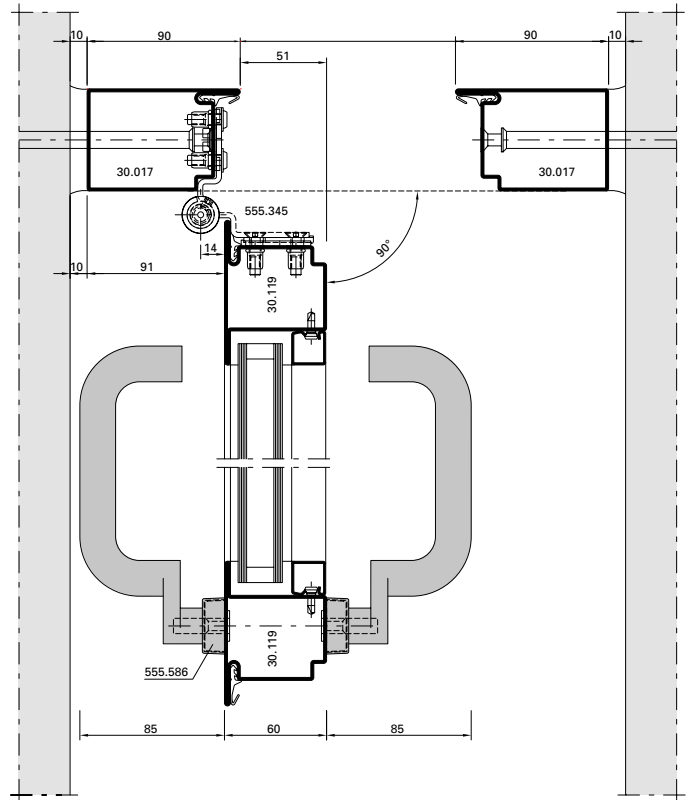

DXF **DWG** *D-250-E-019*

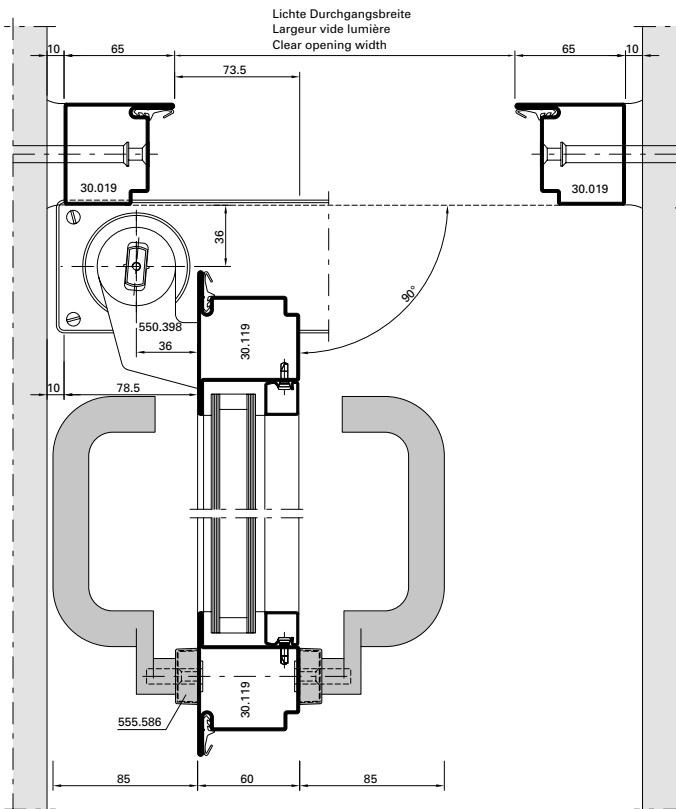

DXF **DWG** *D-250-E-022*

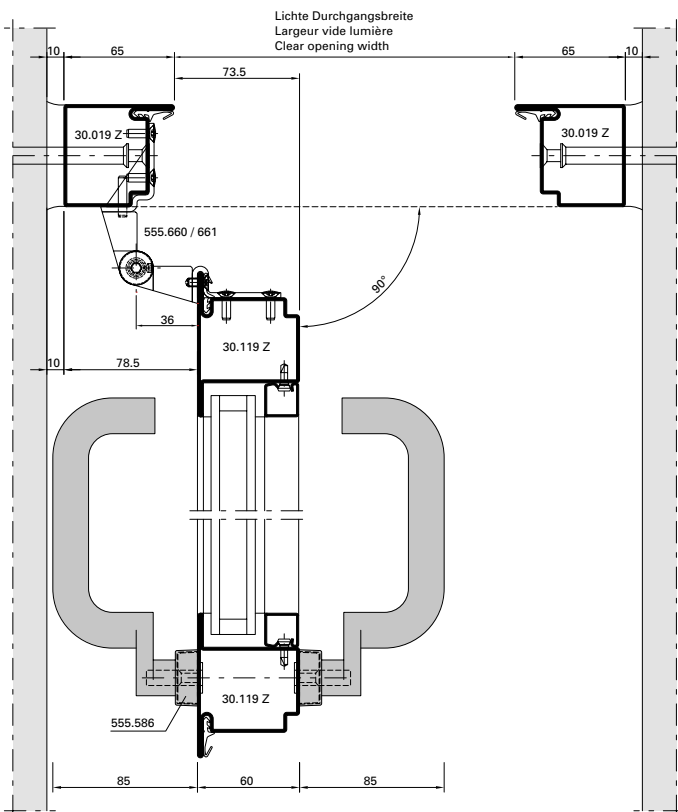

DXF **DWG** *D-250-E-023*

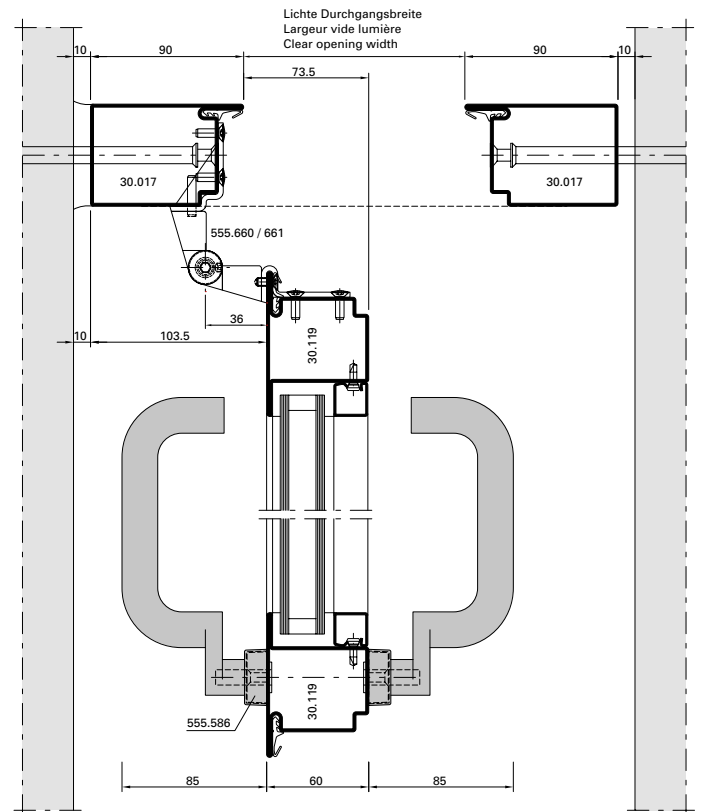

DXF **DWG** *D-250-E-024*

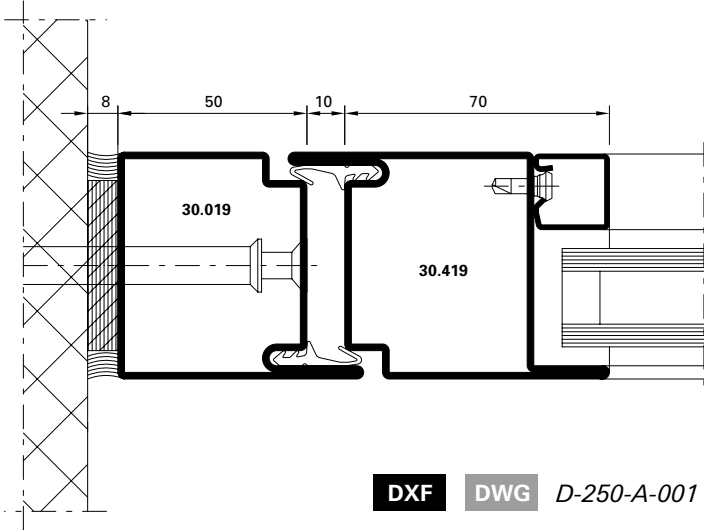

DXF DWG D-250-A-001

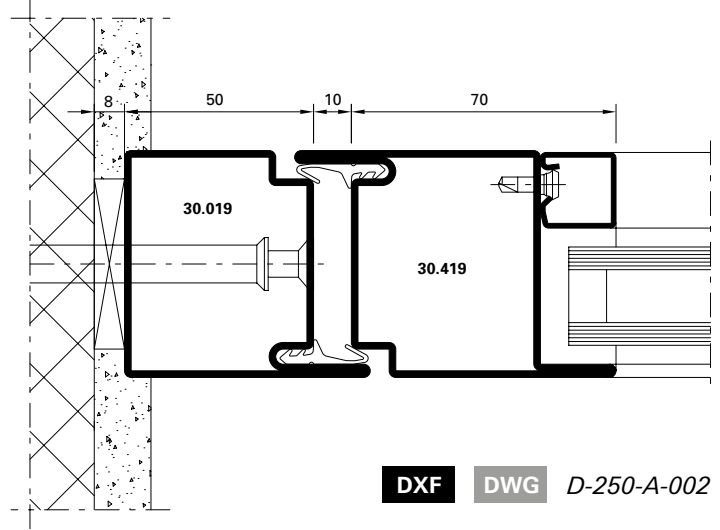

DXF DWG D-250-A-002

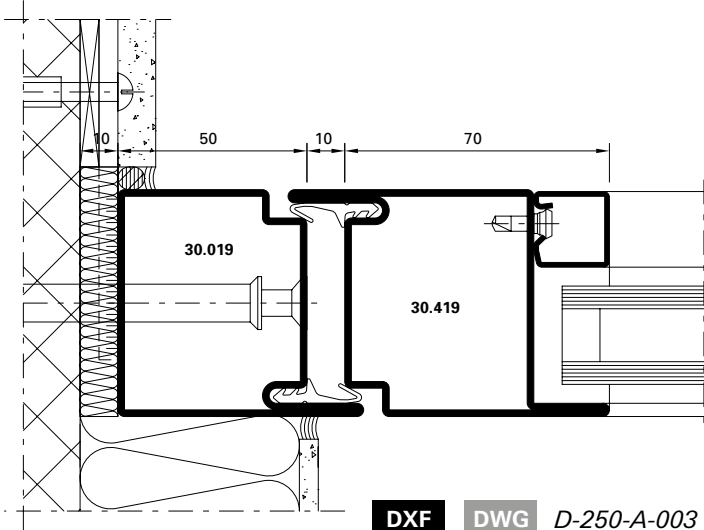

DXF DWG D-250-A-003

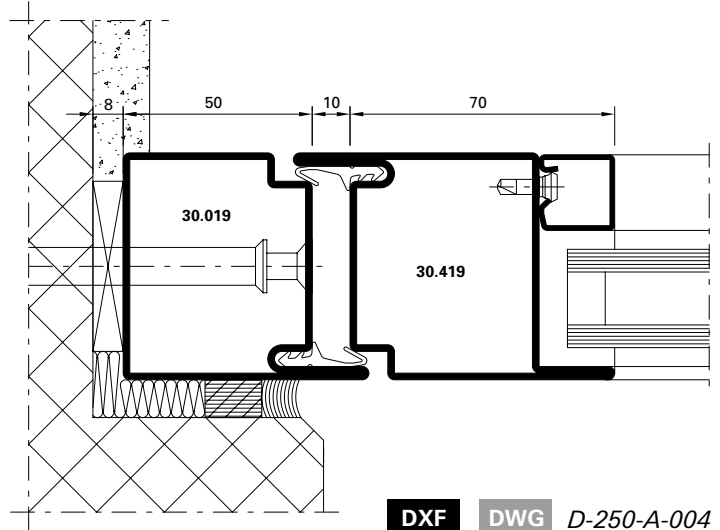

DXF DWG D-250-A-004

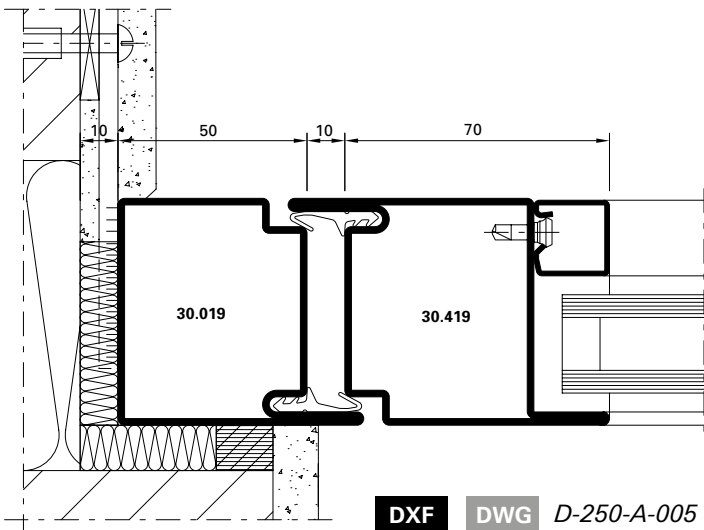

DXF DWG D-250-A-005

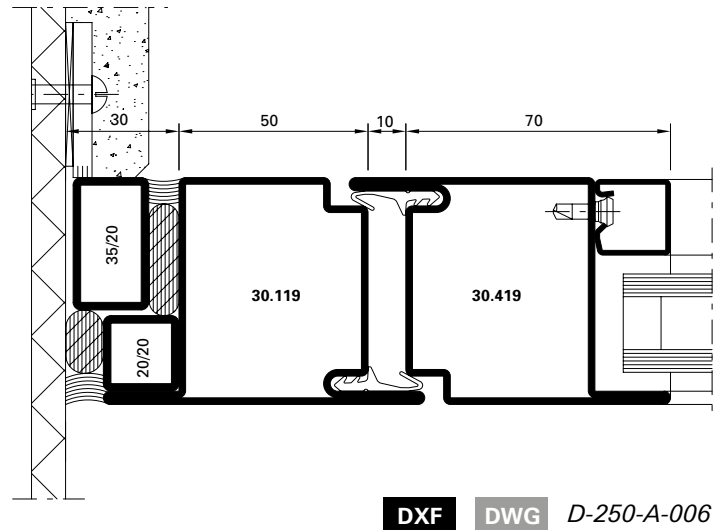

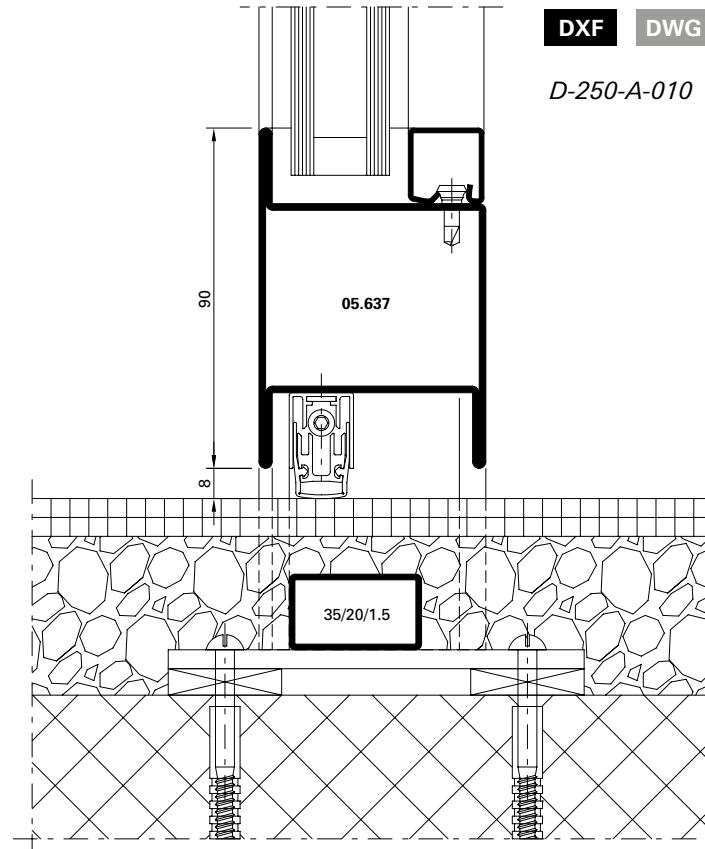
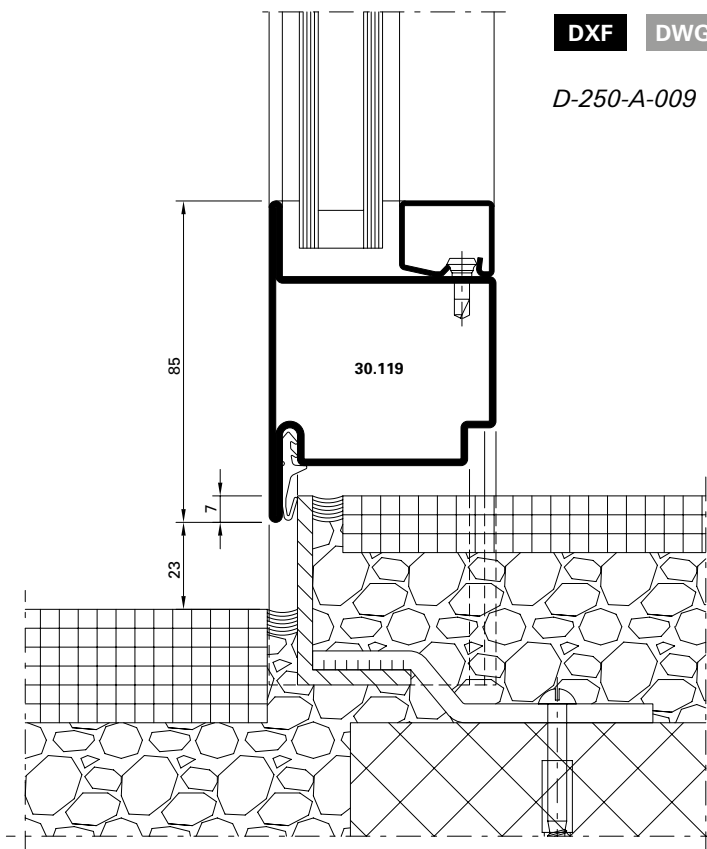
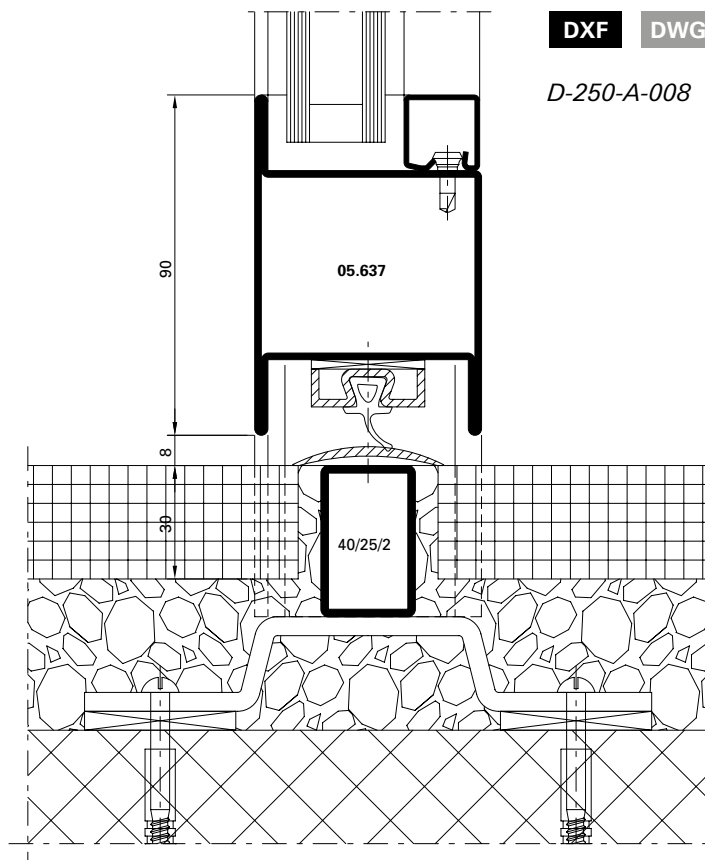
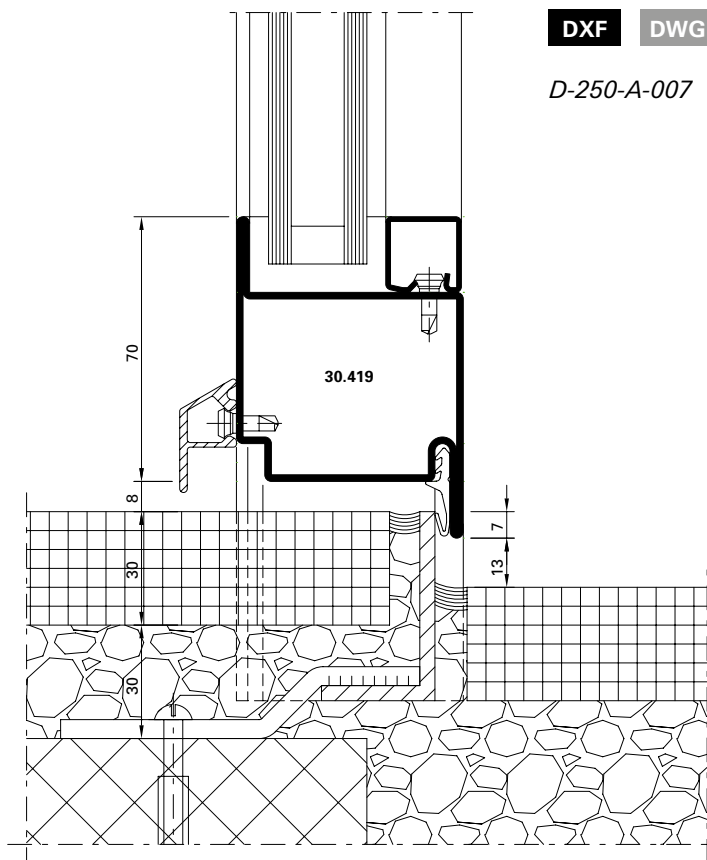

DXF DWG D-250-A-006



Einflügelige Türen,
 auswärts öffnend,
 Flügelhöhe ≤ 2200 mm

Porte à un vantail,
 ouvrant vers l'extérieur,
 hauteur du vantail ≤ 2200 mm

Single leaf door,
 outward opening,
 leaf height ≤ 2200 mm

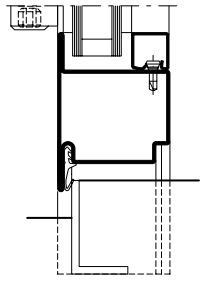
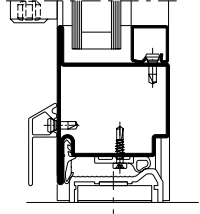
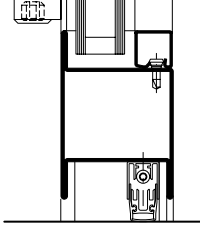
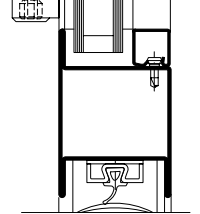
Variante	Beschlag Ferrure Fitting	 EN 12207	 EN 12208	 EN 12210	
Anschlagdichtung Joint de butée Rebate gasket		1	2	1A	C4
		2	2	2A	C4
		3	3	2A	C5
Doppel-Anschlagdichtung Joint de base double Double rebate gasket		1	4	3A	C4
		2	4	3A	C4
		3	4	5A	C5
Senkdichtung Joint seuil Drop seal		1	2	1A	C4
		2	2	2A	C4
		3	3	2A	C5
Auflaufdichtung Joint de contact Ramp seal		1	2	0	C4
		2	2	0	C4
		3	2	0	C5

1 Fallenriegel-Schloss
 Serrure à mortaiser
 Latch and bolt lock





2 Schloss mit Obenverriegelung
 Serrure avec verrouillage supérieur
 Lock with top locking point

3 Mehrfachverriegelungs-Schloss
 Serrure à verrouillage multiple
 Multipoint lock

Einflügelige Türen,
 einwärts öffnend,
 Flügelhöhe ≤ 2200 mm

Porte à un vantail,
 ouvrant vers l'intérieur,
 hauteur du vantail ≤ 2200 mm

Single leaf door,
 inward opening,
 leaf height ≤ 2200 mm

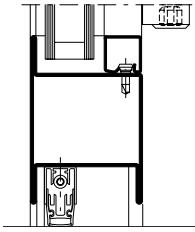
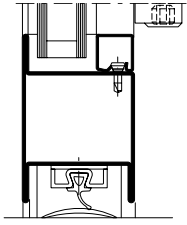
Variante		Beschlag Ferrure Fitting	 EN 12207	 EN 12208	 EN 12210
Senkdichtung Joint seuil Drop seal		❶	2	0	C4
		❷	2	0	C4
		❸	3	1A	C5
Auflaufdichtung Joint de contact Ramp seal		❶	2	0	C4
		❷	2	0	C4
		❸	2	0	C5

❶ Fallenriegel-Schloss
 Serrure à mortaiser
 Latch and bolt lock



❷ Schloss mit Obenverriegelung
 Serrure avec verrouillage supérieur
 Lock with top locking point

❸ Mehrfachverriegelungs-Schloss
 Serrure à verrouillage multiple
 Multipoint lock

Einflügelige Türen,
 auswärts öffnend,
 Flügelhöhe ≤ 3000 mm

Porte à un vantail,
 ouvrant vers l'extérieur,
 hauteur du vantail ≤ 3000 mm

Single leaf door,
 outward opening,
 leaf height ≤ 3000 mm

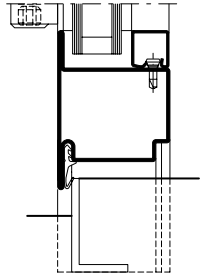
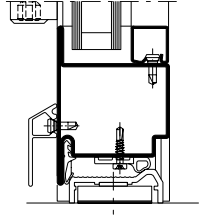
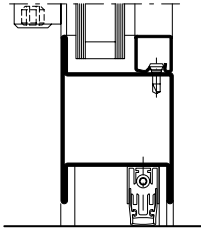
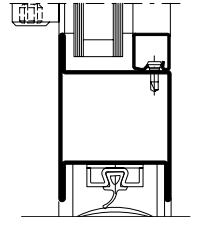
Variante	Beschlag Ferrure Fitting	 EN 12207	 EN 12208	 EN 12210
Anschlagdichtung Joint de butée Rebate gasket 	1	1	0	C1
	2	1	0	C1
	3	1	0	C2
Doppel-Anschlagdichtung Joint de base double Double rebate gasket 	1	1	1A	C1
	2	1	1A	C1
	3	2	2A	C2
Senkdichtung Joint seuil Drop seal 	1	1	0	C1
	2	1	0	C1
	3	1	0	C2
Auflaufdichtung Joint de contact Ramp seal 	1	0	0	C1
	2	0	0	C1
	3	1	0	C2

1 Fallenriegel-Schloss
 Serrure à mortaiser
 Latch and bolt lock





2 Schloss mit Obenverriegelung
 Serrure avec verrouillage supérieur
 Lock with top locking point

3 Mehrfachverriegelungs-Schloss
 Serrure à verrouillage multiple
 Multipoint lock

Einflügelige Türen,
 einwärts öffnend,
 Flügelhöhe ≤ 3000 mm

Porte à un vantail,
 ouvrant vers l'intérieur,
 hauteur du vantail ≤ 3000 mm

Single leaf door,
 inward opening,
 leaf height ≤ 3000 mm

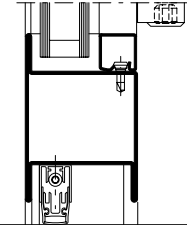
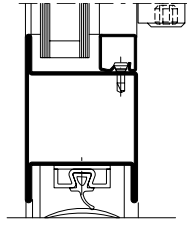
Variante		Beschlag Ferrure Fitting	 EN 12207	 EN 12208	 EN 12210
Senkdichtung Joint seuil Drop seal		❶	1	0	C1
		❷	1	0	C1
		❸	1	0	C2
Auflaufdichtung Joint de contact Ramp seal		❶	0	0	C1
		❷	0	0	C1
		❸	1	0	C2

❶ Fallenriegel-Schloss
 Serrure à mortaiser
 Latch and bolt lock



❷ Schloss mit Obenverriegelung
 Serrure avec verrouillage supérieur
 Lock with top locking point

❸ Mehrfachverriegelungs-Schloss
 Serrure à verrouillage multiple
 Multipoint lock

Zweiflügelige Türen,
 auswärts öffnend,
 Flügelhöhe ≤ 2200 mm

Porte à deux vantaux,
 ouvrant vers l'extérieur,
 hauteur du vantail ≤ 2200 mm

Double leaf door,
 outward opening,
 leaf height ≤ 2200 mm

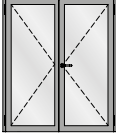
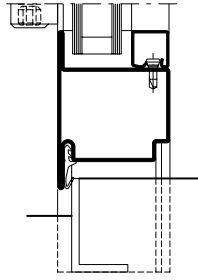
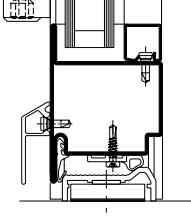
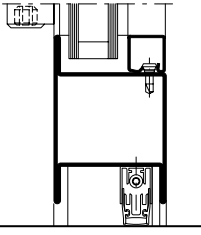
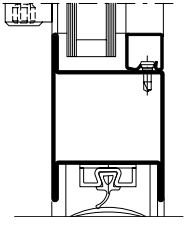
Variante	Beschlag Ferrure Fitting	 EN 12207	 EN 12208	 EN 12210	
					
Anschlagdichtung Joint de butée Rebate gasket		❶	2	1A	C2
		❷	2	2A	C2
		❸	2	2A	C3
Doppel-Anschlagdichtung Joint de base double Double rebate gasket		❶	2	2A	C2
		❷	2	2A	C2
		❸	3	3A	C3
Senkdichtung Joint seuil Drop seal		❶	2	1A	C2
		❷	2	2A	C2
		❸	2	2A	C3
Auflaufdichtung Joint de contact Ramp seal		❶	2	0	C2
		❷	2	0	C2
		❸	2	0	C3

❶ Fallenriegel-Schloss
 Serrure à mortaiser
 Latch and bolt lock





❷ Schloss mit Obenverriegelung
 Serrure avec verrouillage supérieur
 Lock with top locking point

❸ Mehrfachverriegelungs-Schloss
 Serrure à verrouillage multiple
 Multipoint lock

Zweiflügelige Türen,
 einwärts öffnend,
 Flügelhöhe ≤ 2200 mm

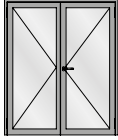
Porte à deux vantaux,
 ouvrant vers l'intérieur,
 hauteur du vantail ≤ 2200 mm

Double leaf door,
 inward opening,
 leaf height ≤ 2200 mm

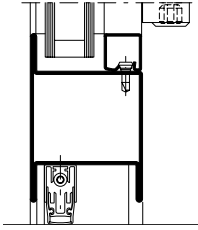
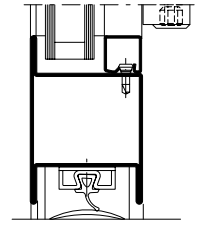
Variante		Beschlag Ferrure Fitting	 EN 12207	 EN 12208	 EN 12210
Senkdichtung Joint seuil Drop seal		❶	2	0	C2
		❷	2	0	C2
		❸	2	0	C3
Auflaufdichtung Joint de contact Ramp seal		❶	2	0	C2
		❷	2	0	C2
		❸	2	0	C3

❶ Fallenriegel-Schloss
 Serrure à mortaiser
 Latch and bolt lock



❷ Schloss mit Obenverriegelung
 Serrure avec verrouillage supérieur
 Lock with top locking point

❸ Mehrfachverriegelungs-Schloss
 Serrure à verrouillage multiple
 Multipoint lock

Zweiflügelige Türen,
 auswärts öffnend,
 Flügelhöhe ≤ 3000 mm

Porte à deux vantaux,
 ouvrant vers l'extérieur,
 hauteur du vantail ≤ 3000 mm

Double leaf door,
 outward opening,
 leaf height ≤ 3000 mm

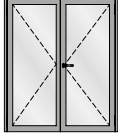
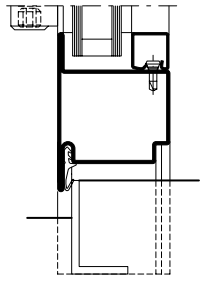
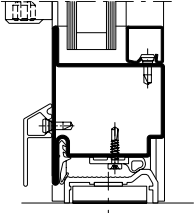
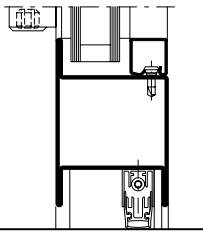
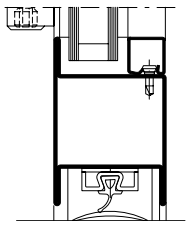
Variante	Beschlag Ferrure Fitting	 EN 12207	 EN 12208	 EN 12210	
					
Anschlagdichtung Joint de butée Rebate gasket		1	0	0	C1
		2	0	0	C1
		3	1	0	C2
Doppel-Anschlagdichtung Joint de base double Double rebate gasket		1	1	0	C1
		2	1	0	C1
		3	2	0	C2
Senkdichtung Joint seuil Drop seal		1	0	0	C1
		2	0	0	C1
		3	1	0	C2
Auflaufdichtung Joint de contact Ramp seal		1	0	0	C1
		2	0	0	C1
		3	1	0	C2

1 Fallenriegel-Schloss
 Serrure à mortaiser
 Latch and bolt lock





2 Schloss mit Obenverriegelung
 Serrure avec verrouillage supérieur
 Lock with top locking point

3 Mehrfachverriegelungs-Schloss
 Serrure à verrouillage multiple
 Multipoint lock

Zweiflügelige Türen,
 einwärts öffnend,
 Flügelhöhe ≤ 3000 mm

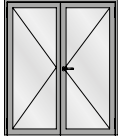
Porte à deux vantaux,
 ouvrant vers l'intérieur,
 hauteur du vantail ≤ 3000 mm

Double leaf door,
 inward opening,
 leaf height ≤ 3000 mm

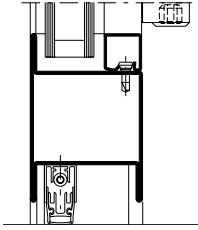
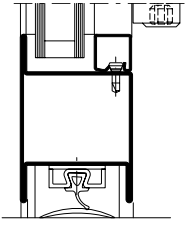
Variante		Beschlag Ferrure Fitting	 EN 12207	 EN 12208	 EN 12210
Senkdichtung Joint seuil Drop seal		1	0	0	C1
		2	0	0	C1
		3	1	0	C2
Auflaufdichtung Joint de contact Ramp seal		1	0	0	C1
		2	0	0	C1
		3	1	0	C2

U_f-Werte
(nach EN ISO 10077-2:2018-01)

Valeurs U_f
(selon EN ISO 10077-2:2018-01)

U_f values
(according to
EN ISO 10077-2:2018-01)

Auf den folgenden Seiten
finden Sie die U_f-Werte für die
verschiedenen Anwendungen von
Jansen-Economy 60.

Vous trouverez les valeurs U_f
pour les différentes applications
Jansen-Economy 60 dans les
pages qui suivent.

On the following pages you
will find the U_f values for the
various applications for
Jansen-Economy 60.

Sie basieren auf folgenden
Grundlagen:

Elles se basent sur les principes
suivants:

They are based on the following:

Stahl

- Profile bandverzinkter Stahl,
unbeschichtet
- Stahl-Glasleisten
- Trockenverglasung
- Nassverglasung

Acier

- Profilés en bande d'acier zingué,
sans revêtement
- Parcloses en acier
- Vitrage à sec
- Vitrage à mastic



Steel

- Strip galvanised steel profiles,
uncoated
- Steel glazing beads
- Glazing with dry glazing
- Glazing with sealing

U_f-Werte
 (nach EN ISO 10077-2:2018-01)

Valeurs U_f
 (selon EN ISO 10077-2:2018-01)

U_f values
 (according to EN ISO 10077-2:2018-01)

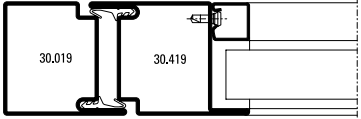
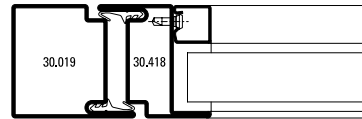
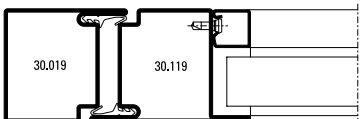
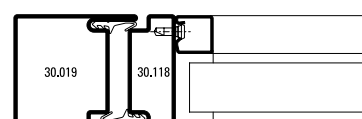
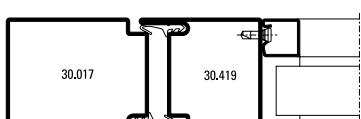
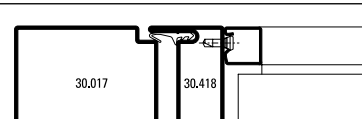
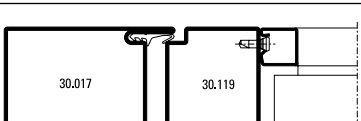
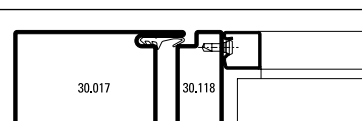
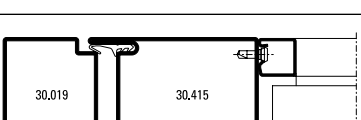
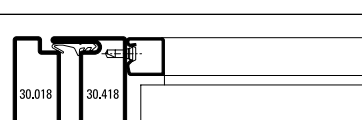
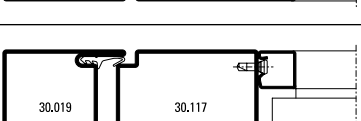
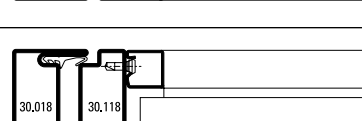
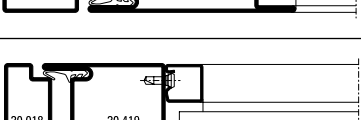
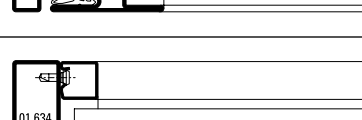
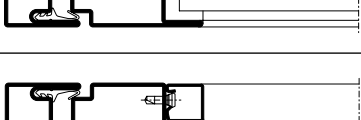
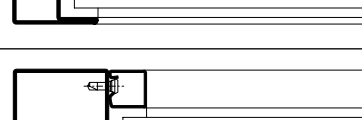
 Füllelementstärken Elements de remplissages Infill elements ≥ 24 mm		 Füllelementstärken Elements de remplissages Infill elements ≥ 24 mm	
	5,5 W/m ² K		5,7 W/m ² K
	5,6 W/m ² K		5,8 W/m ² K
	5,3 W/m ² K		5,5 W/m ² K
	5,3 W/m ² K		5,5 W/m ² K
	5,3 W/m ² K		6,0 W/m ² K
	5,3 W/m ² K		6,1 W/m ² K
	5,6 W/m ² K		6,9 W/m ² K
	5,7 W/m ² K		6,1 W/m ² K

U_f-Werte
 (nach EN ISO 10077-2:2018-01)

Valeurs U_f
 (selon EN ISO 10077-2:2018-01)

U_f values
 (according to EN ISO 10077-2:2018-01)

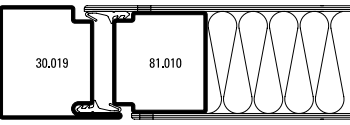
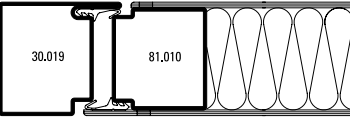
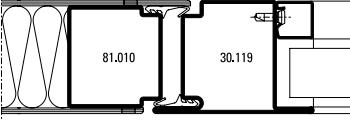
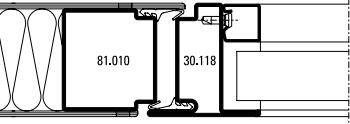
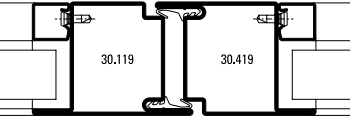
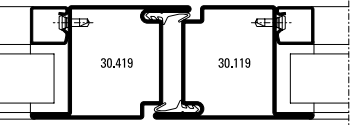
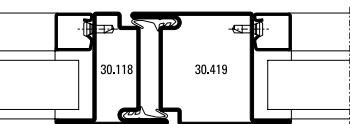
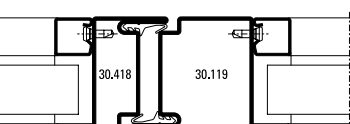

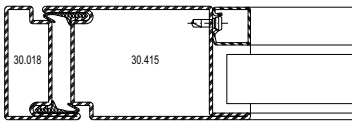
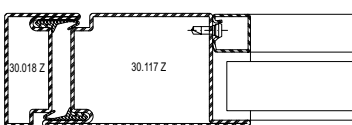
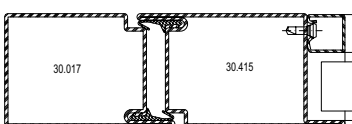
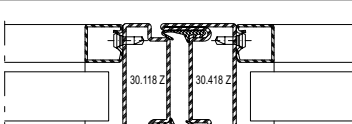
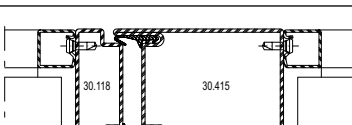
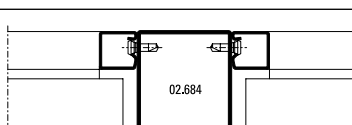
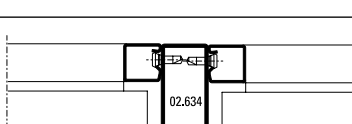
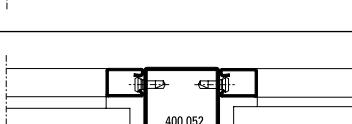
	Füllelementstärken Elements de remplissages Infill elements
	≥ 24 mm
	5,3 W/m²K
	5,3 W/m²K
	5,7 W/m²K
	6,0 W/m²K
	5,8 W/m²K
	5,8 W/m²K
	6,1 W/m²K
	6,1 W/m²K

	Füllelementstärken Elements de remplissages Infill elements
	≥ 24 mm
	5,3 W/m²K
	5,4 W/m²K
	5,1 W/m²K
	6,5 W/m²K
	5,7 W/m²K
	6,3 W/m²K
	7,2 W/m²K
	6,4 W/m²K

U_f-Werte
 (nach EN ISO 10077-2:2018-01)

Valeurs U_f
 (selon EN ISO 10077-2:2018-01)

U_f values
 (according to EN ISO 10077-2:2018-01)

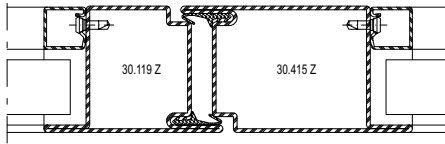
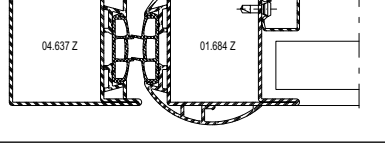
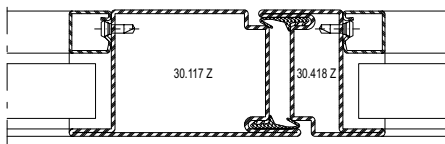
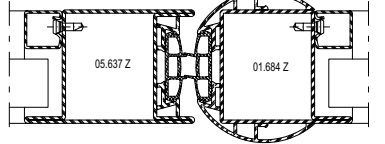
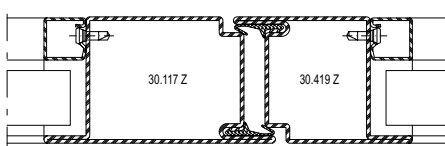
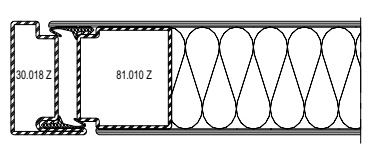
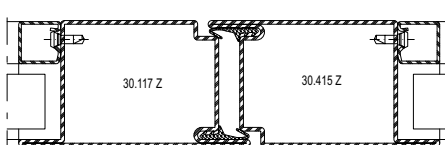
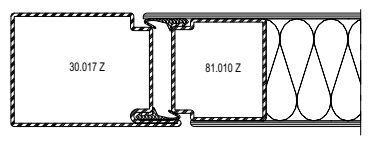
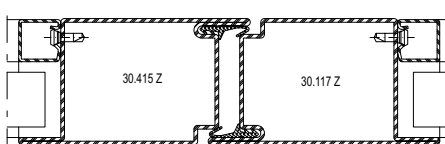
	Füllelementstärken Elements de remplissages Infill elements ≥ 24 mm		Füllelementstärken Elements de remplissages Infill elements ≥ 24 mm
	5,5 W/m²K		5,8 W/m²K
	5,7 W/m²K		6,0 W/m²K
	5,5 W/m²K		5,4 W/m²K
	5,3 W/m²K		5,1 W/m²K
	5,3 W/m²K		

U_f-Werte
 (nach EN ISO 10077-2:2018-01)

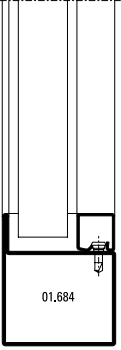
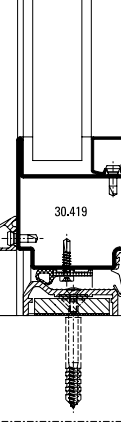
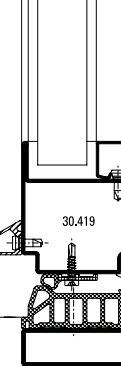
 Füllelementstärken Elements de remplissages Infill elements ≥ 24 mm	
 01.684	6,1 W/m ² K
 30.419	6,3 W/m ² K
 30.419	5,6 W/m ² K

Valeurs U_f
 (selon EN ISO 10077-2:2018-01)

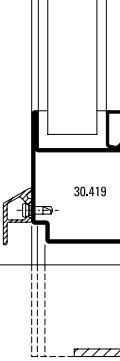
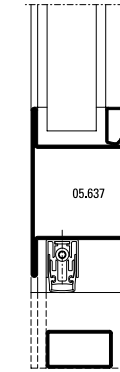
 Füllelementstärken Elements de remplissages Infill elements ≥ 24 mm	
 30.419	6,3 W/m ² K
 05.637	5,6 W/m ² K

U_f values
 (according to EN ISO 10077-2:2018-01)

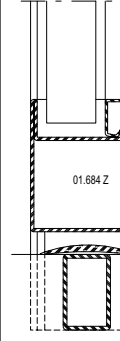
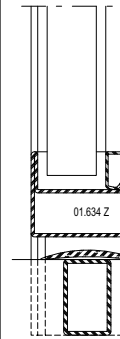
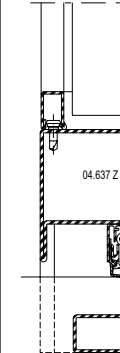
 Füllelementstärken Elements de remplissages Infill elements ≥ 24 mm	
 01.684 Z	6,1 W/m ² K
 01.634 Z	6,8 W/m ² K
 04.637 Z	5,5 W/m ² K

U_f-Werte
 (nach EN ISO 10077-2:2018-01)

Valeurs U_f
 (selon EN ISO 10077-2:2018-01)

U_f values
 (according to EN ISO 10077-2:2018-01)

	Füllelementstärken Elements de remplissages Infill elements
	$\geq 24 \text{ mm}$
	$5,6 \text{ W/m}^2\text{K}$

	Füllelementstärken Elements de remplissages Infill elements
	$\geq 24 \text{ mm}$
	$5,6 \text{ W/m}^2\text{K}$

	Füllelementstärken Elements de remplissages Infill elements
	$\geq 24 \text{ mm}$
	$5,7 \text{ W/m}^2\text{K}$

	$4,4 \text{ W/m}^2\text{K}$
--	-----------------------------

	$5,7 \text{ W/m}^2\text{K}$
--	-----------------------------

	$5,2 \text{ W/m}^2\text{K}$
--	-----------------------------



Schallschutz

Ausführungsvarianten

Die nachfolgende Typenübersicht ergibt einen Überblick über die beurteilten Varianten.

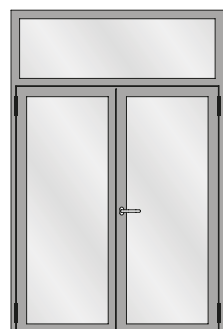
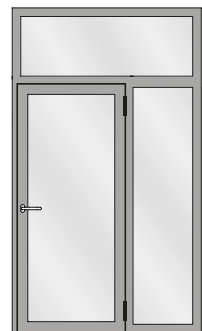
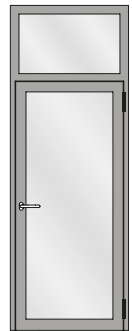
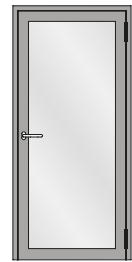

Isolation phonique

Modèles

L'aperçu des types suivant fournit une vue d'ensemble des variantes examinées.

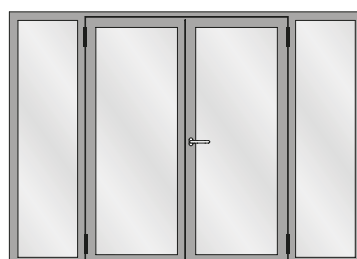
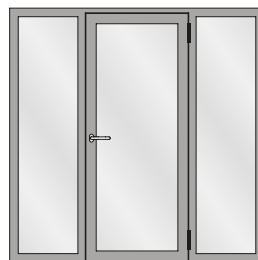
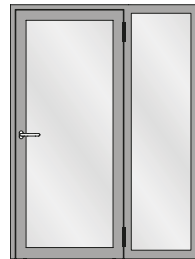
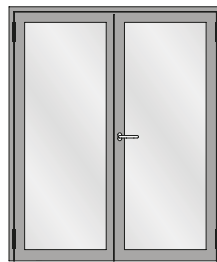

Sound insulation

Design range

The following overview of types provides an overview of the evaluated designs.

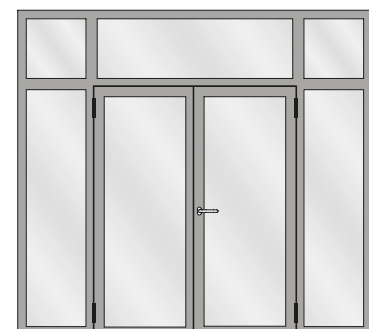
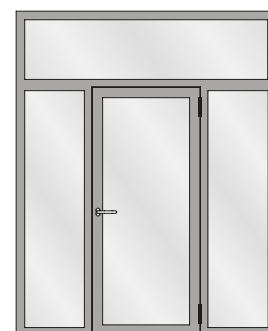

Schallschutz

Isolation phonique

Sound insulation

Tabelle A1

Korrekturtabelle für Jansen-Economy-Türen mit Glasfüllungen

Tableau A1

Tableau de correction pour les portes Jansen-Economy avec vitrage

Table A1

Correction table for Jansen-Economy doors with glass

	1	2	3	4	5	6	7	8	9	10	11
	Türe mit zwei absenkba- ren Bodendichtungen Porte avec deux joint seuil automatique Door with two threshold gaskets that can be lowered	Glas Verre Glass	Korrekturen Corrections Corrections								
	$R_{w(C, Ctr)}$ dB	$R_{w, P, Glas}$ dB	K_S dB	K_{FV} dB	K_{Nass} dB	K_{1aB} dB	$K_{W/S}$ dB	$K_{G 0,4}$ dB	$K_{G 1,8}$ dB	$K_{G 2,6}$ dB	$K_{G 3,2}$ dB
1	32 (-1; -5)	31	0	-1	0	0	0	0	-1	-2	-3
2	33 (-1; -5)	32	0	-1	0	0	0	0	-1	-2	-3
3	35 (-1; -5)	34	0	-1	0	0	0	0	-1	-2	-3
4	36 (-2; -5)	35	0	-1	-1	0	0	0	-1	-2	-3
5	37 (-2; -5)	37	0	0	-1	0	-1	0	-1	-2	-3
6	38 (-2; -5)	39	0	0	-1	-1	-1	0	-1	-2	-3
7	39 (-2; -5)	40	0	0	-1	-1	-1	0	-1	-2	-3
8	40 (-2; -5)	41	0	0	-1	-1	-2	-1	-1	-2	-3
9	41 (-2; -5)	42	0	0	-1	-1	-2	-2	-1	-2	-3
10	42 (-2; -5)	43	-1	0	-1	-1	-2	-2	-1	-2	-3
11	42 (-2; -5)	44	-1	0	-1	-1	-2	-2	-1	-2	-3
12	43 (-2; -5)	45	-1	+1	-1	-1	-3	-3	-1	-2	-3
13	44 (-2; -5)	49	-1	+1	-1	-2	-3	-3	-1	-2	-3

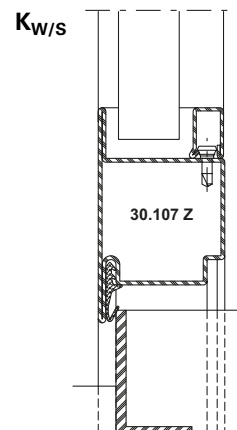
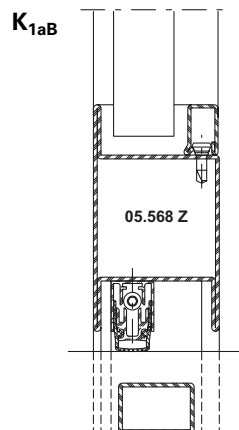
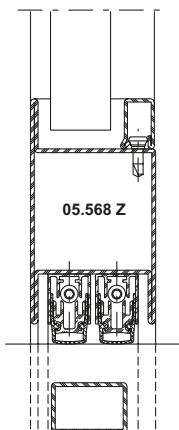

Schallschutz

Der aus der Tabelle A1 abzulesende Wert für die Schalldämmung $R_{w, Tür}$ beträgt:

Isolation phonique

La valeur à relever sur le tableau A1 concernant l'isolement contre les sons aériens $R_{w, Porte}$ est la suivante:

Sound insulation

The value taken from table A1 for the sound insulation $R_{w, Door}$ is:

$$R_{w, Tür} = R_w + K_S + K_{FV} + K_{Nass} + K_{1aB} + K_{W/S} + K_{Band} + K_{G 0,4} + K_{G 1,8} + K_{G 2,6} + K_{G 3,2} \text{ dB}$$

- R_w** bewertetes Schalldämm-Mass der Türe in Abhängigkeit von der Schalldämmung $R_{w,P, Glas}$
- $R_{w,P, Glas}$** bewertetes Schalldämm-Mass der Verglasung (Prüfwert nach ISO 140-3, mit Prüfnachweis einer PÜZ-Stelle). Alternativ können Tabellenwerte nach DIN EN 12758, Abschnitt 6 verwendet werden
- K_S** Korrekturwert für zweiflügelige Türen
- K_{FV}** Korrekturwert für Festverglasungen mit erhöhtem Scheibenanteil
- K_{Nass}** Korrekturwert für Nassverglasung
- K_{1aB}** Korrekturwert für Türen mit einer absenkbaren Bodendichtung
- K_{Band}** Korrekturwert bei Verwendung von Anschlagbändern, die eine Dichtungsebene unterbrechen ($K_{Band} = - 0,5 \text{ dB pro Band}$)
- $K_{W/S}$** Korrekturwert für Türen mit einer Anschlagsschwelle
- $K_{G 0,4}$** Korrekturwert für Einzelscheiben mit einer Glasfläche $\leq 0,4 \text{ m}^2$. Die Korrektur gilt auch für Konstruktionen mit glasteilenden Sprossen.
- $K_{G 1,8}$** Korrekturwert für Einzelscheiben mit einer Glasfläche $\geq 1,8 \text{ m}^2$
- $K_{G 2,6}$** Korrekturwert für Einzelscheiben mit einer Glasfläche $\geq 2,6 \text{ m}^2$
- $K_{G 3,2}$** Korrekturwert für Einzelscheiben mit einer Glasfläche $\geq 3,2 \text{ m}^2$

- R_w** Mesure d'isolement contre les sons aériens des portes évaluée suivant l'isolement phonique $R_{w,P, Glas}$
- $R_{w,P, Glas}$** Cote d'isolement acoustique du vitrage évalué (valeur contrôlée selon ISO 140-3 avec certificat d'un bureau de contrôle, de surveillance ou de certification). Il est également possible d'utiliser les valeurs selon le tableau DIN EN 12758, section 6
- K_S** Valeur de correction pour portes à deux vantaux
- K_{FV}** Valeur de correction pour vitrages fixes à fort pourcentage de vitre
- K_{Nass}** Valeur de correction pour vitrage avec mastic
- K_{1aB}** Valeur de correction pour portes avec un joint seuil automatique
- K_{Band}** Valeur corrective en cas d'utilisation de paumelles qui interrompent un plan d'étanchéité ($K_{Band} = - 0,5 \text{ dB par paumelle}$)
- $K_{W/S}$** Valeur de correction pour portes avec un seuil de butée
- $K_{G 0,4}$** Valeur de correction pour vitres individuelles avec une surface vitrée $\leq 0,4 \text{ m}^2$. La correction s'applique aussi aux constructions à meneaux séparant les vitres.
- $K_{G 1,8}$** Valeur de correction pour vitres individuelles avec surface vitrée $\geq 1,8 \text{ m}^2$
- $K_{G 2,6}$** Valeur de correction pour vitres individuelles avec surface vitrée $\geq 2,6 \text{ m}^2$
- $K_{G 3,2}$** Valeur de correction pour vitres individuelles avec surface vitrée $\geq 3,2 \text{ m}^2$

- R_w** Airborne sound reduction index of doors depending on the sound insulation $R_{w,P, Glas}$
- $R_{w,P, Glas}$** Airborne sound reduction index (test value in accordance with ISO 140-3, with a test certificate from a recognised testing, inspection or certification body). Alternatively, the tabulated values in DIN EN 12758, Section 6 may be used
- K_S** Correction value for double-leaf doors
- K_{FV}** Correction value for fixed glazing with increased proportion of pane
- K_{Nass}** Correction value for glazing with sealing
- K_{1aB}** Correction value for doors with a threshold gasket that can be lowered
- K_{Band}** Correction value when using hinges that interrupt a sealing plane ($K_{Band} = - 0.5 \text{ dB per hinge}$)
- $K_{W/S}$** Correction value for doors with a rebate threshold
- $K_{G 0,4}$** Correction value for single panes with a glass area $\leq 0,4 \text{ m}^2$. The correction also applies to buildings with glazing bars
- $K_{G 1,8}$** Correction value for single panes with a glass area $\geq 1,8 \text{ m}^2$
- $K_{G 2,6}$** Correction value for single panes with a glass area $\geq 2,6 \text{ m}^2$
- $K_{G 3,2}$** Correction value for single panes with a glass area $\geq 3,2 \text{ m}^2$

Jansen-Economy 60 Türen

Türen aus Stahl

Portes Jansen-Economy 60

Portes en acier

Jansen-Economy 60 doors

Doors in steel

Grafische Planungsdaten wie z.B. Anwendungsbeispiele, Konstruktionsdetails, Anschlüsse am Bau, die in unseren physischen oder elektronischen Dokumentationsunterlagen enthalten sind, sind schematische Darstellungen. Gleiches gilt für digitale Medien wie CAD Dateien oder BIM Modelle.

Sie sollen den ausführenden Metallbauer und/oder Fachplaner bei der Planung und Ausführung eines Projektes unterstützen. Sie sind im konkreten Anwendungsfall durch den ausführenden Metallbauer und/oder Fachplaner auf die Verwendbarkeit im konkreten betroffenen Projekt hinsichtlich rechtlichen/regulatorischen aber auch technischen objektspezifischen Anforderungen zu überprüfen und ggfs. eigenverantwortlich anzupassen.

Bei der Überprüfung, der spezifischen Planung und der Umsetzung sind die objektspezifischen Rahmenbedingungen (Material der Bausubstanz, Dimension des Einbauelements, Farbe, Exposition, Lasteinwirkung, etc.) sowie der geltende Stand der Technik einschliesslich aller anwendbaren Normen und technischen Richtlinien eigenverantwortlich zu beachten.

Falls das vorliegende Dokument Differenzen zur aktuellen deutschen Version (Artikel Nr. K1214237) aufweist, gilt in jedem Fall der deutsche Originaltext in der jeweils geltenden Fassung im Jansen Docu Center.

Alle Ausführungen dieser Dokumentation haben wir sorgfältig und nach bestem Wissen zusammengestellt. Wir können aber keine Verantwortung für die Benutzung der vermittelten Vorschläge und Daten übernehmen. Wir behalten uns technische Änderungen ohne Vorankündigung vor.

Les données de planification graphiques, comme les exemples d'application, détails de construction et raccordements au bâtiment, fournies dans notre documentation physique et numérique sont des représentations schématiques. Il en va de même pour les médias numériques comme les fichiers CAD ou modèles BIM.

Leur but est de faciliter la planification et réalisation d'un projet par les constructeurs métalliques et/ou concepteurs. Concrètement, elles doivent être vérifiées par le constructeur métallique et/ou le concepteur et, le cas échéant, modifiées de son propre chef pour s'assurer qu'elles concordent avec le projet concerné et qu'elles répondent aux exigences techniques spécifiques ainsi qu'aux dispositions légales et réglementaires.

Lors de la vérification, de la planification spécifique et de la mise en œuvre, il y a lieu de tenir compte des conditions spécifiques à l'objet (matériaux du bâtiment, dimension de l'élément d'insert, couleur, exposition, effet de charge, etc.) ainsi que de l'état actuel de la technique, y compris toutes les normes et directives techniques applicables.

En cas de divergence entre le présent document et la version allemande (no d'article K1214237), c'est dans tous les cas le texte original allemand qui prévaut dans sa version actuelle disponible dans le Jansen Docu Center.

Nous avons apporté le plus grand soin à l'élaboration de cette documentation. Cependant, nous déclinons toute responsabilité pour l'utilisation faite de nos propositions et de nos données.

Nous nous réservons le droit de procéder à des modifications techniques sans préavis.

Graphical planning data such as application examples, construction details, connections on site that are contained in our physical or electronic documentation components are schematic representations. The same applies to digital media such as CAD files or BIM models.

They are intended to support the metal worker and/or design engineer in planning and executing projects. In the specific case of application they are to be checked by the metal worker and/or design engineer in terms of their usability in the specific project concerned with regard to legal/regulatory and technical property-specific requirements and adjusted if necessary at the latter's own responsibility.

The property-specific underlying conditions (construction material, dimensions of installation element, colour, exposure, load effect etc.) and current state of the art including all applicable norms and technical guidelines are to be taken into consideration at the metal worker and/or design engineer's own responsibility during the review, specific planning and implementation.

If there are any differences between this document and the current German version (item number K1214237), the latest version of the original German text in the Jansen Docu Center shall prevail.

All the information contained in this documentation is given to the best of our knowledge and ability. However, we decline all responsibility for the use made of these suggestions and data.

We reserve the right to effect technical modifications without prior warning.

Inhaltsverzeichnis Sommaire Content	Jansen-Economy 60 Türen Jansen-Economy 60 portes Jansen-Economy 60 doors	2	
Systemübersicht Merkmale Leistungseigenschaften Systemausführungen Typenübersicht	Sommaire du système Caractéristiques Caractéristiques de performance Exécutions de système Sommaire des types	Summary of system Characteristics Performance characteristics System versions Summary of types	2
Profilsortiment	Assortiment de profilé	Range of profiles	14
Beispiele Schnittpunkte Konstruktionsdetails Anschlüsse am Bau	Exemples Coupes de détails Détails de construction Raccords au mur	Examples Section details Construction details Attachment to structure	18
Leistungseigenschaften	Caractéristiques de performance	Performance characteristics	36

Merkmale
Caractéristiques
Characteristics

Jansen-Economy 60 Türen
Jansen-Economy 60 portes
Jansen-Economy 60 doors







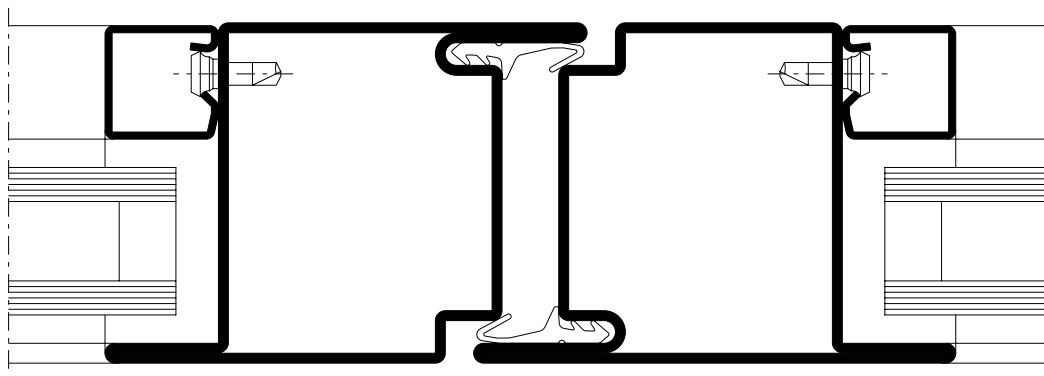

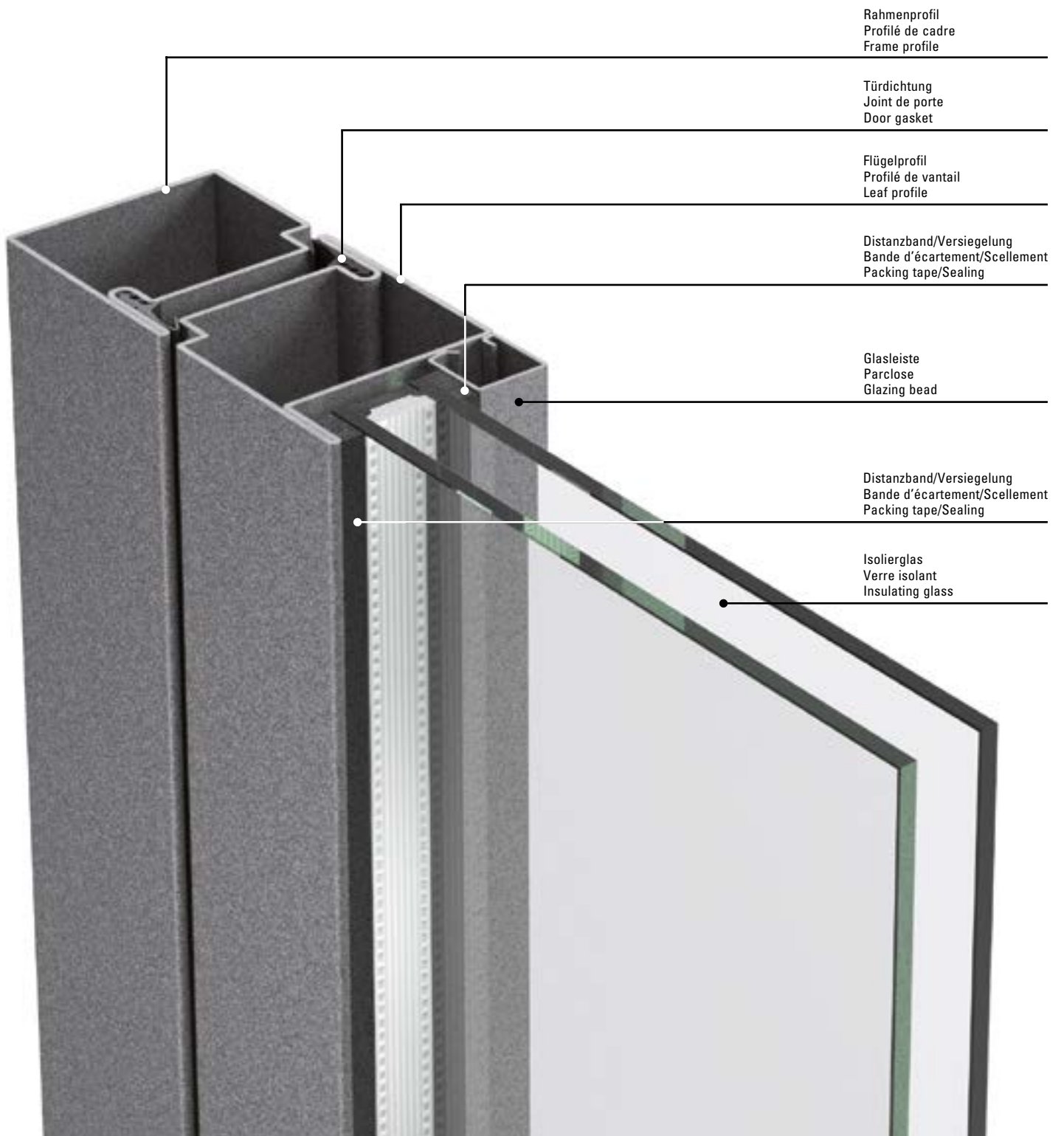

- Stahlsystem für Türen und Festverglasungen
- Bautiefe 60 mm, innen und aussen flächenbündig
- Schmale Ansichtsbreiten: Rahmen und Flügel ab 105 mm Stulppartie 150 mm
- Ein- und zweiflüglige Türen, nach innen und aussen öffnend, mit Oberlicht oder Festverglasung kombinierbar
- Türflügel bis 1465 x 3000 mm (BxH), Flügelgewicht bis 230 kg
- Füllelementstärke von 5 bis 36 mm, Glaseinbau mittels Trocken- oder Nassverglasung
- Systemprüfungen nach Produktnorm EN 14351-1
- Stahlprofile blank oder bandverzinkt
- Grosses Sortiment an systemgeprüften Türbeschlägen
- Barrierefreie Schwellenausbildungen
- Geeignet für Pulver- und Nasslackbeschichtungen

- Système en acier pour portes et vitrages fixes
- Profondeur de montage 60 mm, montage à fleur à l'intérieur et à l'extérieur
- Fines largeurs de face: Cadre et vantaux à partir de 105 mm Partie tête 150 mm
- Portes à un et deux vantaux, ouverture vers l'intérieur et vers l'extérieur, combinables avec imposte ou vitrage fixe
- Vantaux de porte jusqu'à 1465 x 3000 mm (LaxH), poids du vantail jusqu'à 230 kg
- Élément de remplissage de 5 à 36 mm d'épaisseur, Montage du vitrage à sec ou à silicone
- Contrôles des systèmes selon la norme produit EN 14351-1
- Profilés en acier brut ou galvanisé en continu
- Grand assortiment de ferrures de porte homologuées
- Formes de seuil sans barrière
- Convient aux revêtements par poudre ou peinture liquide

- Steel system for doors and fixed glazing
- 60 mm basic depth, flush-fitted on the inside and outside
- Narrow face widths: Frame and leaf from 105 mm Meeting stile assembly 150 mm
- Single and double-leaf doors, inward and outward-opening, can be combined with toplight or fixed glazing
- Door leaf up to 1465 x 3000 mm (WxH), leaf weight up to 230 kg
- Infill unit thickness of 5 to 36 mm, Glazing installed by means of dry or wet glazing
- System tests in accordance with the product standard EN 14351-1
- Raw finish or pre-galvanised steel profiles
- Large range of system-tested door fittings
- Easy-access thresholds
- Suitable for powder and wet paint coating





Norm	Eigenschaft Caractéristique Characteristic	Klassifizierung/Wert Classification / Valeur Classification / Value											
		npd	1 (400)	2 (800)	3 (1200)	4 (1600)	5 (2000)	Exxx (>2000)					
 EN 12210	Widerstandsfähigkeit bei Windlast Résistance à la pression du vent Resistance to wind load	npd	1 (400)	2 (800)	3 (1200)	4 (1600)	5 (2000)	Exxx (>2000)					
 EN 12208	Schlagregendichtheit Étanchéité à la pluie battante Watertightness	npd	1A (0)	2A (50)	3A (100)	4A (150)	5A (200)	6A (250)	7A (300)	8A (450)	9A (600)	Exxx (>750)	
 EN ISO 10140	Schalldämmung R_w (C, C_{tr}) (dB) Isolation phonique R_w (C, C_{tr}) (dB) Sound insulation R_w (C, C_{tr}) (dB)	npd	bis R_w 44 dB (-2; -5) jusqu'à R_w 44 dB (-2; -5) up to R_w 44 dB (-2; -5)										
 EN ISO 10077-2	Wärmedurchgangskoeffizient U_f (W/(m ² ·K)) Transmission thermique U_f (W/(m ² ·K)) Thermal production U_f (W/(m ² ·K))	npd	ab 5.65 W/m ² K à partir de 5.65 W/m ² K from 5.65 W/m ² K										
 EN 12207	Luftdurchlässigkeit Perméabilité à l'air Air permeability	npd	1 (150)		2 (300)		3 (600)		4 (600)				
 EN 1192	Klassifizierung der Festigkeitsanforderungen Classification des exigences de résistance méca. Classification of strength requirements	npd	1		2		3		4				
 EN 1627	Einbruchhemmung Anti-effraction Burglar resistance	npd	1		2		3		4		5		6
 EN 1522	Durchschusshemmung Résistance aux balles Bullet proofing	npd	FB1	FB2	FB3	FB4	FB5	FB6	FB7	FSG			
 EN 1191 EN 1603	Dauerfunktionsprüfung Durabilité mécanique Mechanical durability	D	1 5'000	2 10'000	3 20'000	4 50'000	5 100'000	6 200'000	7 500'000	8 1'000'000			
 EN 179 EN 1125	Fähigkeit zur Freigabe Capacité au déclenchement Ability to release		Anforderung erfüllt Exigence remplie Requirement fulfilled										

Norm	Eigenschaft Caractéristique Characteristic	Klassifizierung/Wert Classification / Valeur Classification / Value			
 EN 12217	Bedienkräfte Forces de manœuvre Operating forces	npd	0	1	2
 EN 1634-3 DIN 18095	Rauchschutz Étanchéité à la fumée Smoke control	S _a / S ₂₀₀ / RS			
 EN 16034 EN 13501-2	Selbstschliessung Fermeture automatique Self-closing	C			
 EN 16034	Dauerhaftigkeit der Selbstschliessung gegenüber Alterung (Korrosion) Endurance de la fermeture automatique contre le vieillissement (corrosion) Durability of self-closing against ageing (corrosion)	erzielt atteinte achieved			



Einbruchhemmende Jansen-Economy 60 Türen

- Türflügelgrößen 1465 x 3000 mm
- Ein- und zweiflügelige Türen, nach innen und aussen öffnend
- Geprüft nach EN 1627
- Panik- und Normalausführung

Portes anti-effraction Jansen-Economy 60

- Dimensions de vantail de porte 1465 x 3000 mm
- Portes à un/deux vantaux à ouverture vers l'intérieur et l'extérieur
- Contrôlé selon la norme EN 1627
- Exécution panique et exécution normale

Burglar-resistant Jansen Economy 60 doors

- Door leaf sizes 1465 x 3000 mm
- Single and double-leaf doors, inward and outward opening
- Tested in accordance with EN 1627
- Panic and standard design



Durchschusshemmende Jansen-Economy 60 Türen

- Türflügelgrößen 1465 x 3000 mm
- Ein- und zweiflügelige Türen, nach innen und aussen öffnend
- Geprüft nach EN 1522

Portes pare-balles Jansen-Economy 60

- Dimensions de vantail de porte 1465 x 3000 mm
- Portes à un/deux vantaux à ouverture vers l'intérieur et l'extérieur
- Contrôlé selon la norme EN 1522

Bullet-resistant Jansen Economy 60 doors

- Door leaf sizes 1465 x 3000 mm
- Single and double-leaf doors, inward and outward opening
- Tested in accordance with EN 1522



Fluchttürsysteme

- Verschlussystem für Notausgangstüren nach EN 179
- Verschlussystem für Paniktüren nach EN 1125
- Barrierefreie Türen ohne Schwelle für behindertengerechtes Bauen
- Ein- und zweiflügelige Türen nach innen und aussen öffnend
- Türflügelgrößen bis 1465 x 3000 mm und Flügelgewicht bis 230 kg

Systèmes de porte de secours

- Système de fermeture pour portes de secours selon EN 179
- Système de fermeture pour portes panique selon EN 1125
- Portes sans seuil pour faciliter l'accès aux personnes handicapées
- Portes à un/deux vantaux à ouverture vers l'intérieur et l'extérieur
- Dimensions de vantail de porte jusqu'à 1465 x 3000 mm et poids de vantail jusqu'à 230 kg

Emergency exit systems

- Closing system for emergency exit doors in accordance with EN 179
- Closing system for panic doors in accordance with EN 1125
- Barrier-free doors without threshold for accessible buildings
- Single and double-leaf doors, inward and outward opening
- Door leaf sizes up to 1465 x 3000 mm and leaf weight up to 230 kg



Jansen-Economy 60 Fingerschutzüren

- Keine Quetsch- und Scherstellen nach DIN 18650
- Wartungsarme Bandlager unten und oben
- Geeignet für Gebäude mit starkem Publikumsverkehr
- Geprüft nach EN 14351-1

Portes anti-pince-doigts Jansen-Economy 60

- Absence de zones d'écrasement et de cisaillement selon DIN 18650
- Paliers de paumelle inférieur et supérieur exigeant peu de maintenance
- Adapté à des bâtiments publics fortement fréquentés
- Contrôlé selon la norme EN 14351-1

Jansen Economy 60 anti-finger-trap doors

- No crushing and shearing points as per DIN 18650
- Low-maintenance hinge bush at top and bottom
- Suitable for buildings subject to frequent use by the public
- Tested in accordance with EN 14351-1



Verblechte Jansen-Economy 60 Türen

- Flächenbündig verblechte Türen
- Geschweisst oder geklebt
- Nach innen und aussen öffnend
- Mit Glasausschnitt möglich

Portes tôlées Jansen-Economy 60

- Portes tôlées à fleur
- Soudées ou collées
- Ouverture vers l'intérieur et l'extérieur
- Panneau de verre possible

Jansen Economy 60 sheet metal doors

- Flush-fitted sheet metal doors
- Welded or bonded
- Inward and outward-opening
- Can have glass vision panel



Jansen-Economy 60 Faltwand

- Nach innen und aussen öffnend
- Leichtgängige, geräuscharme Bedienung
- Schwellenlose Ausführung
- Flügelgewichte bis 100 kg

Porte repliable Jansen-Economy 60

- Ouverture vers l'intérieur et l'extérieur
- Mobilité silencieuse
- Exécution sans seuil
- Poids de vantail jusqu'à 100 kg

Jansen Economy 60 folding wall

- Inward and outward-opening
- Smooth and quiet operation
- Design without a threshold
- Vent weights up to 100 kg

Jansen Docu Center

Die Plattform zum effizienten Arbeiten mit Jansen Dokumentationen. Im Jansen Docu Center stehen alle Produktinformationen jederzeit digital in der aktuellsten Version zur Verfügung: von Architekten-Informationen über Bestell- und Fertigungskatalogen bis hin zu Anleitungen und Prospekten sowie Videos.

Die Inhalte können einfach und schnell aufgerufen werden. Ein für den Anwender komfortables papierloses Arbeiten, das zahlreiche Vorteile bietet.

Download CAD Daten

DXF

DWG

Sie können die Zeichnungen in den Formaten DXF und/oder DWG herunterladen. Klicken Sie auf das entsprechende Icon und der Download erfolgt.

Die Hinweise «Artikelbibliothek/Türbeschläge/Fensterbeschläge» bedeuten, dass Sie mit einem Klick die gesamte Artikelbibliothek des entsprechenden Systems herunterladen (Profile, Beschläge, Glasleisten, Zubehör etc.).

Info und Beratung

Gerne beraten wir Sie persönlich und stehen Ihnen bei Fragen zur Verfügung. Bitte schreiben Sie uns Ihre Anliegen an: info@jansen.com

Jansen Docu Center

La plate-forme pour travailler efficacement avec les documentations Jansen. Le Jansen Docu Center met à votre disposition les informations sur les produits, en format numérique et dans une version actualisée: des catalogues de commande et de fabrication aux instructions et prospectus, en passant par les informations destinées aux architectes et vidéos.

Les contenus sont facilement et rapidement accessibles. Une manière de travailler confortable et offrant de nombreux avantages.

Télécharger fichiers DAO

DXF

DWG

Vous pouvez télécharger les dessins aux formats DXF et/ou DWG. Cliquez sur l'icône correspondante et le téléchargement s'effectuera.

Les indications «Bibliothèque des articles/Ferures de porte/Ferrures de fenêtres» signifie que vous téléchargez la totalité de la bibliothèque des articles du système donné (profilés, ferrures, parclofes, accessoires etc.).

Info et conseils

Nous vous conseillerons volontiers individuellement et sommes à votre disposition si vous avez des questions à poser. Veuillez nous envoyer votre requête à: info@jansen.com

Jansen Docu Center

The platform for working efficiently with Jansen documentation. The latest version of all the product information is available digitally at any time in the Jansen Docu Center – from order and fabrication manuals to architect information, instructions and brochures and videos.

The content can be retrieved quickly and easily. The user can work conveniently without paper, which has numerous benefits.

Download CAD files

DXF

DWG

You can download the drawings in DXF and/or DWG format. Click on the relevant icon to begin the download.

The items «Article library/Door fittings/Window fittings» means that you download the entire article library for the corresponding system with one click (profiles, fittings, glazing beads, accessories etc.).

Information and advice

We would be delighted to provide you with advice in person and are available to answer any questions you may have. Please write to us with your queries at: info@jansen.com

Zulassungen/Prüfungen
Homologations/Essais
Authorisations/Tests

Jansen-Economy 60 Türen
Jansen-Economy 60 portes
Jansen-Economy 60 doors

Elementgrößen
(Empfehlung für CE-Kennzeichnung)

Dimensions des éléments
(Recommandation pour le label CE)

Size of elements
(Recommendation for CE marking)

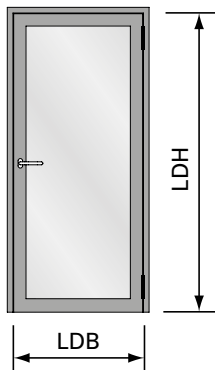

LDB Lichte Durchgangsbreite
max. 1400 mm
min. 490 mm

LDB Largeur vide lumière
max. 1400 mm
min. 490 mm

LDB Clear opening width
max. 1400 mm
min. 490 mm

LDH Lichte Durchgangshöhe
max. 3000 mm
min. 1900 mm

LDH Hauteur vide lumière
max. 3000 mm
min. 1900 mm

LDH Clear opening height
max. 3000 mm
min. 1900 mm

Flügelgewicht max. 230 kg

Poids de vantail max. 230 kg

Weight of leaf max. 230 kg

Zulassungen/Prüfungen
Homologations/Essais
Authorisations/Tests

Jansen-Economy 60 Türen
Jansen-Economy 60 portes
Jansen-Economy 60 doors

Elementgrößen
(Empfehlung für CE-Kennzeichnung)

Dimensions des éléments
(Recommandation pour le label CE)

Size of elements
(Recommendation for CE marking)

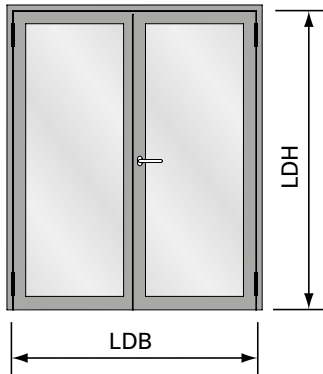

LDB Lichte Durchgangsbreite
max. 2800 mm
min. 1000 mm

LDB Largeur vide lumière
max. 2800 mm
min. 1200 mm

LDB Clear opening width
max. 2800 mm
min. 1000 mm

LDH Lichte Durchgangshöhe
max. 3000 mm
min. 1900 mm

LDH Hauteur vide lumière
max. 3000 mm
min. 1900 mm

LDH Clear opening height
max. 3000 mm
min. 1900 mm

Flügelgewicht max. 230 kg

Poids de vantail max. 230 kg

Weight of leaf max. 230 kg

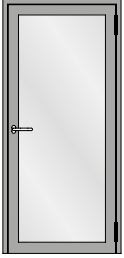

Einflügelige Türe
Porte à un vantail
Single leaf door

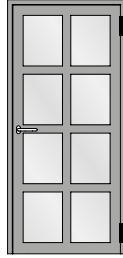

Einflügelige Türe mit Riegel
Porte à un vantail avec traverse
Single leaf door with transom

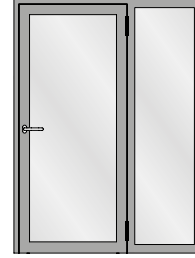

Einflügelige Türe mit Seitenteil
Porte à un vantail avec partie latérale
Single leaf door with side light

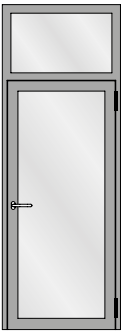

Einflügelige Türe mit Oberlicht
Porte à un vantail avec imposte
Single leaf door with top light

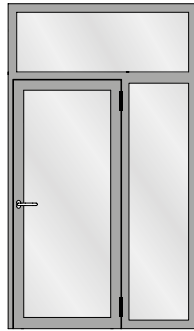

Einflügelige Türe mit Seitenteil und Oberlicht
Porte à un vantail avec avec partie latérale
et imposte
Single leaf door with side light and top light

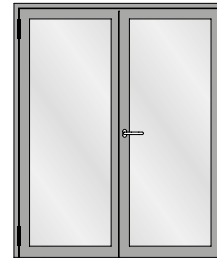

Zweiflügelige Türe
Porte à deux vantaux
Double leaf door



Zweiflügelige Türe mit zwei Seitenteilen
Porte à deux vantaux avec deux parties latérales
Double leaf door with two side lights

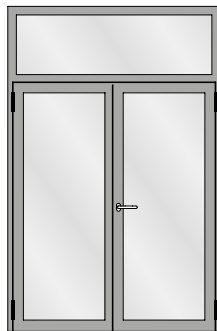

Zweiflügelige Türe mit Oberlicht
Porte à deux vantaux avec imposte
Double leaf door with top light

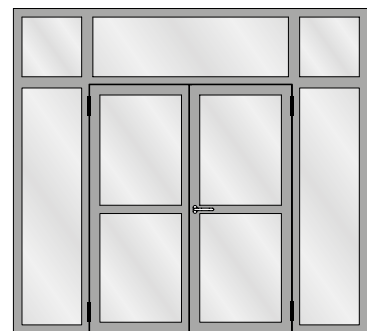

Zweiflügelige Türe mit zwei Seitenteilen und
Oberlichtern
Porte à deux vantaux avec deux parties
latérales et impostes
Double leaf door with two side lights and
top lights

Typenübersicht
Sommaire des types
Summary of types

Jansen-Economy 60 Türen
Jansen-Economy 60 portes
Jansen-Economy 60 doors

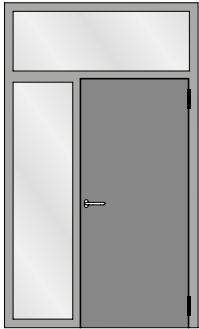

Verblechte Türe mit Seitenteil und Oberlicht
Porte tôlée à un vantail avec avec partie latérale
et imposte
Sheet metal single leaf door with side light
and top light



Verblechte zweiflügelige Türe mit zwei
Seitenteilen und Oberlichtern
Porte tôlée à deux vantaux avec deux parties
latérales et impostes
Sheet metal double leaf door with two side
lights and top lights



Festverglasung
Vitrage fixe
Fixed glazing

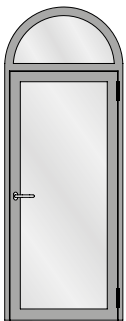

Einflügelige Türe mit Rundbogen-Oberlicht
Porte à un vantail avec imposte demi-ronde
Single leaf door with round arched top light

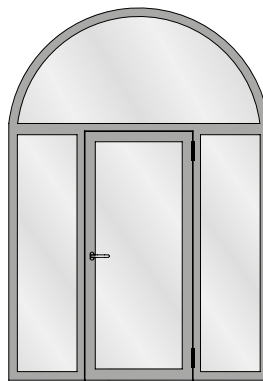

Einflügelige Türe mit zwei Seitenteilen und
Rundbogen-Oberlicht
Porte à un vantail avec deux parties latérales
et imposte demi-ronde
Single leaf door with two side lights and
round arched top light

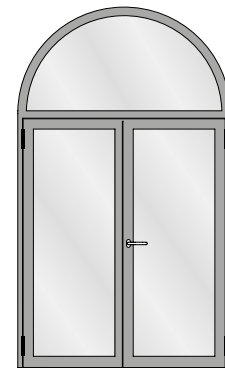

Zweiflügelige Türe mit Rundbogen-Oberlicht
Porte à deux vantaux avec imposte demi-ronde
Double leaf door with round arched top light

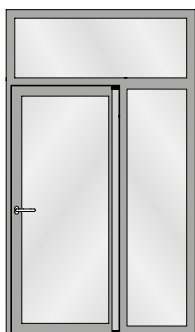

Fingerschutztüre
Porte anti-pince-doigts
Anti-finger-trap door

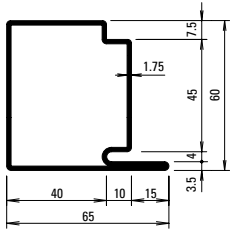

30.019
30.019 Z

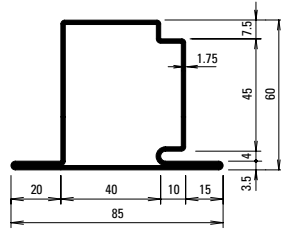

30.119
30.119 Z

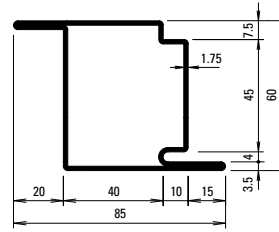

30.419
30.419 Z

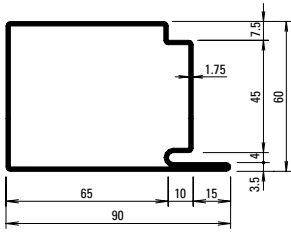

30.017
30.017 Z

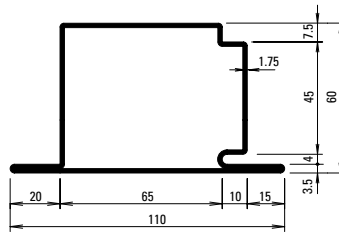

30.117
30.117 Z

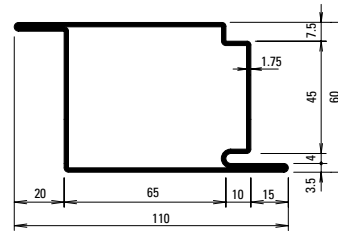

30.415

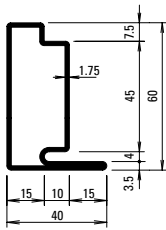

30.018
30.018 Z

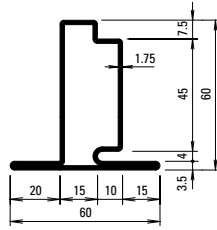

30.118
30.118 Z

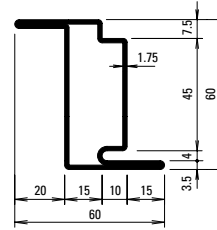

30.418
30.418 Z

Oberfläche/Werkstoff

Artikel-Nr.

ohne Zusatz = blank

mit Z = bandverzinkter Stahl

Surface/Matériau

No. d'article

sans supplément = brut

avec Z = bande d'acier zinguée

Surface/Material

Part no.

without addition = bright

with Z = strip galvanised steel

Profil-Nr.	G kg/m	F cm ²	I _x cm ⁴	W _x cm ³	I _y cm ⁴	W _y cm ³	U m ² /m
30.017	4,200	5,36	31,32	9,09	48,57	10,35	0,312
30.018	2,830	3,61	15,95	4,35	4,77	1,93	0,212
30.019	3,520	4,48	23,69	6,70	19,75	5,55	0,262
30.117	4,750	6,04	34,75	9,35	65,74	11,51	0,350
30.118	3,370	4,29	18,64	4,65	8,26	2,75	0,250
30.119	4,050	5,16	26,80	6,99	29,12	6,58	0,300

Profil-Nr.	G kg/m	F cm ²	I _x cm ⁴	W _x cm ³	I _y cm ⁴	W _y cm ³	U m ² /m
30.415	4,750	6,04	37,79	12,28	65,74	11,51	0,350
30.418	3,370	4,29	22,92	7,37	8,62	2,75	0,250
30.419	4,050	5,16	30,36	9,82	29,12	6,58	0,300

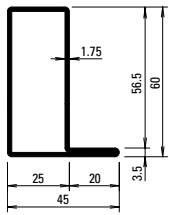

01.634
01.634 Z

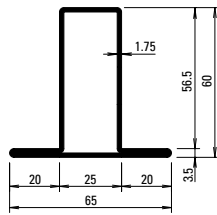

02.634
02.634 Z

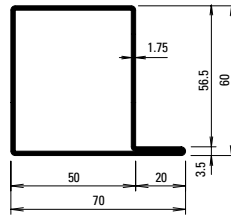

01.684
01.684 Z

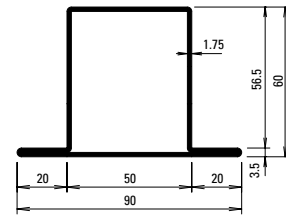

02.684
02.684 Z

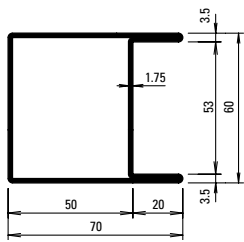

04.637
04.637 Z

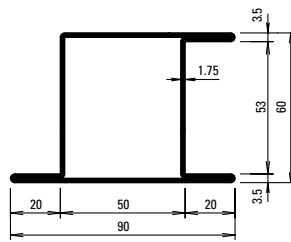

05.637
05.637 Z

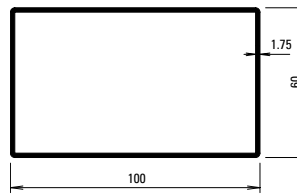

400.051
400.051 Z

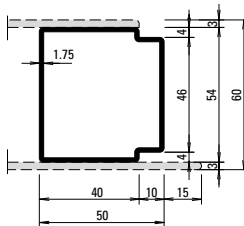

81.010 Z

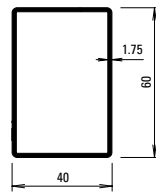

400.052
400.052 Z

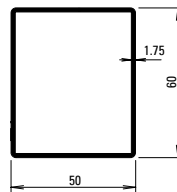

400.054
400.054 Z

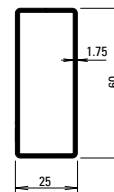

400.055
400.055 Z

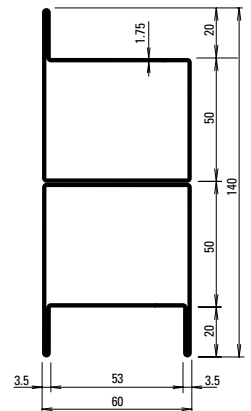

05.001

Profil-Nr.	G kg/m	F cm ²	I _x cm ⁴	W _x cm ³	I _y cm ⁴	W _y cm ³	U m ² /m
01.634	2,730	3,48	16,71	4,71	6,04	2,15	0,204
02.634	3,270	4,17	19,66	5,01	10,34	3,18	0,243
01.684	3,430	4,37	24,34	7,07	22,12	5,59	0,255
02.684	3,960	5,05	27,70	7,36	31,93	7,09	0,294
04.637	3,960	5,05	30,62	10,2	27,45	7,71	0,294
05.637	4,500	5,72	35,42	10,6	39,45	8,02	0,333
81.010	2,700	3,43	14,53	5,38	13,05	5,10	0,202
400.051	4,300	5,44	76,01	15,2	34,64	11,55	0,316
400.052	2,630	3,34	8,98	4,49	16,86	5,62	0,197
400.054	2,900	3,69	14,97	5,98	19,83	6,61	0,217
400.055	2,210	2,82	3,08	2,47	12,41	4,13	0,167

Stabachse
Axe de la barre
Bar axis

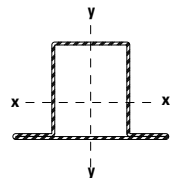

Artikelbibliothek
 Bibliothèque des articles
 Article library

DXF **DWG**

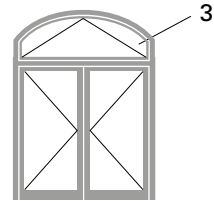
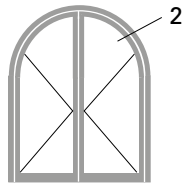
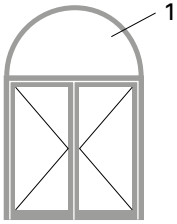

1.0

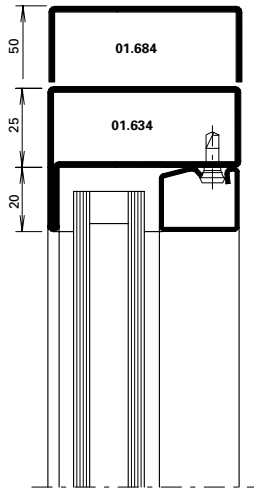

2.0

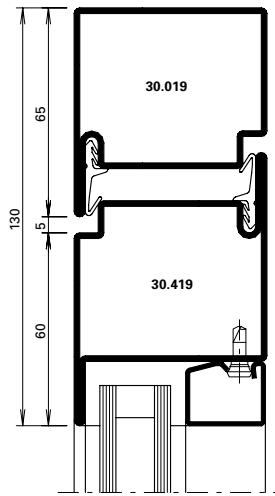

3.0

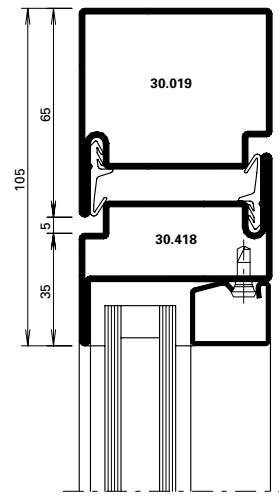

Halbrundbogen
 Arc semi-circulaire
 Semi-circular arch

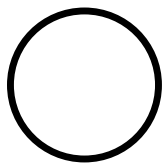

Rundbogen
 Arc en plein centre
 Round arch

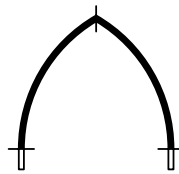

Spitzbogen
 Ogive
 Gothic arch



Stichbogen
 Arc bombé
 Segmented arch



Korbbogen
 Anse de panier
 Oval arch

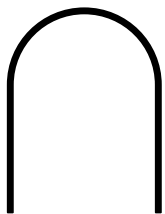

Halbrundbogen mit Schenkel
 Arc surhaussé
 Semi-circular arch with side extension

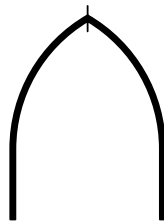

Spitzbogen mit Schenkel
 Arc en ogive
 Gothic arch with side extension

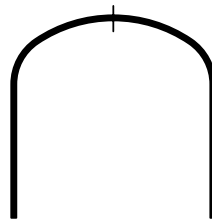



Korbbogen mit Schenkel
 Anse de panier prolongée
 Oval arch with side extension

Bogentüren
Portes cintrées
Arched doors

Jansen-Economy 60 Türen
Jansen-Economy 60 portes
Jansen-Economy 60 doors

Profil Profilé Profile	Min. Radius Rayon min. Min. radius R	
------------------------------	---	--

	blank brut bright	verzinkt zinguée galvanised
	mm	mm
01.634	550	550
01.684	650	650

	blank brut bright	verzinkt zinguée galvanised
	mm	mm
02.634	600	650
02.684	1050	1050

	blank brut bright	verzinkt zinguée galvanised
	mm	mm
04.637	1550	1550

	blank brut bright	verzinkt zinguée galvanised
	mm	mm
05.637	1550	1550

	blank brut bright	verzinkt zinguée galvanised
	mm	mm
400.052	1100	1100
400.054	1000	1000
400.055	800	800
81.010		800

Profil Profilé Profile	Min. Radius Rayon min. Min. radius R	
------------------------------	---	--

	blank brut bright	verzinkt zinguée galvanised
	mm	mm
30.018		550
30.019	650	650

	blank brut bright	verzinkt zinguée galvanised
	mm	mm
30.118	800	800
30.119	900	900

	blank brut bright	verzinkt zinguée galvanised
	mm	mm
30.418	800	800
30.419	1100	1100

Stahl-Glasleisten Parcloses en acier Steel glazing beads	Min. Radius Rayon min. Min. radius R
--	---

	mm
62.507 Z	300 mm
62.508 Z	300 mm
62.509 Z	300 mm

Stahl-Glasleisten Parcloses en acier Steel glazing beads	Min. Radius Rayon min. Min. radius R
--	---

	mm
402.112 Z	500 mm
402.115 Z	500 mm
402.120 Z	600 mm
402.125 Z	750 mm
402.130 Z	1000 mm
402.135 Z	1500 mm

Aluminium-Glasleisten Parcloses en aluminium Aluminium glazing beads	Min. Radius Rayon min. Min. radius R
--	---

	mm
404.109	400 mm
404.112	400 mm
404.115	400 mm
404.120	400 mm
404.125	450 mm
404.130	500 mm
404.135	600 mm

	mm
405.110	500 mm
405.115	500 mm
405.120	500 mm
405.125	800 mm
405.130	1000 mm
406.903	500 mm
406.905	500 mm
406.907	500 mm
406.909	600 mm

Die Radien-Angaben beziehen sich auf die langjährige Erfahrung und Fertigung im Hause Jansen.

Les rayons indiqués se fondent sur la longue expérience et la fabrication au sein de la maison Jansen.

The radii specifications are based on the many years of experience Jansen has in fabrication.

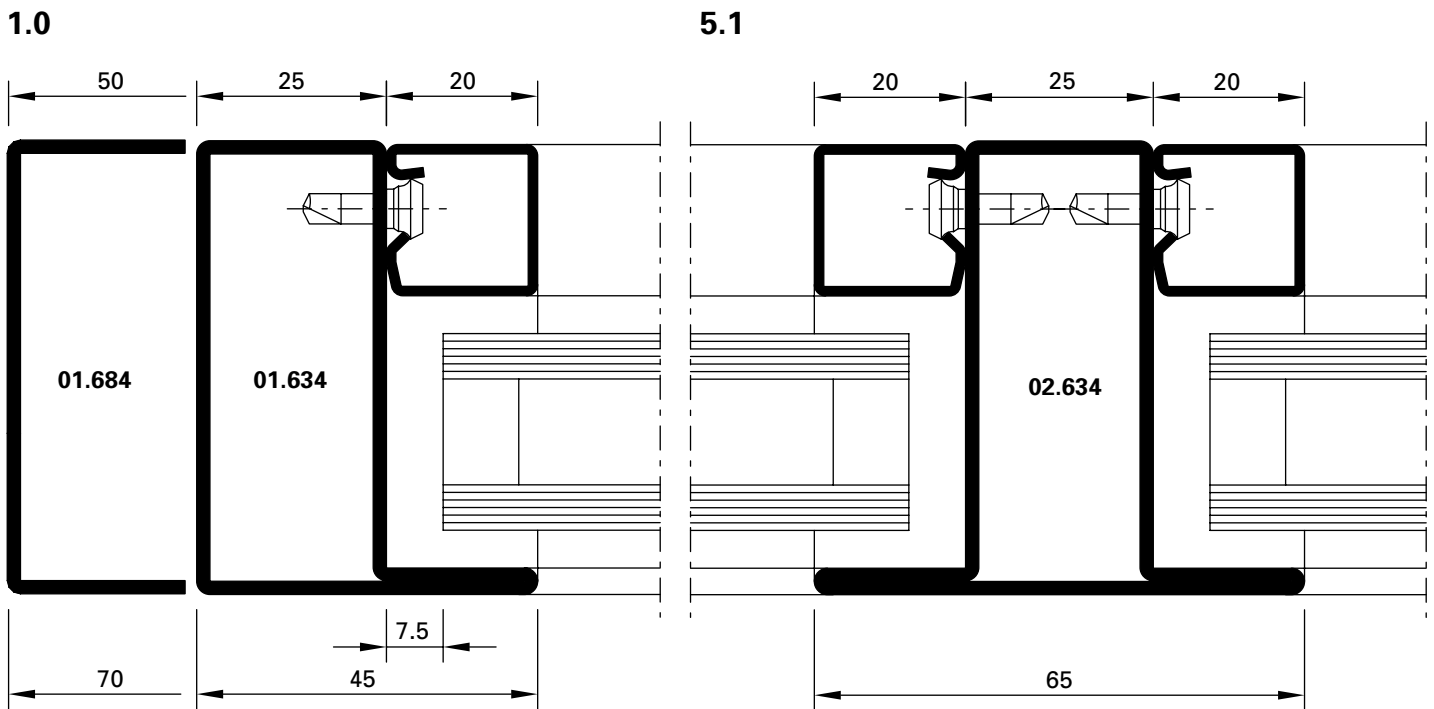
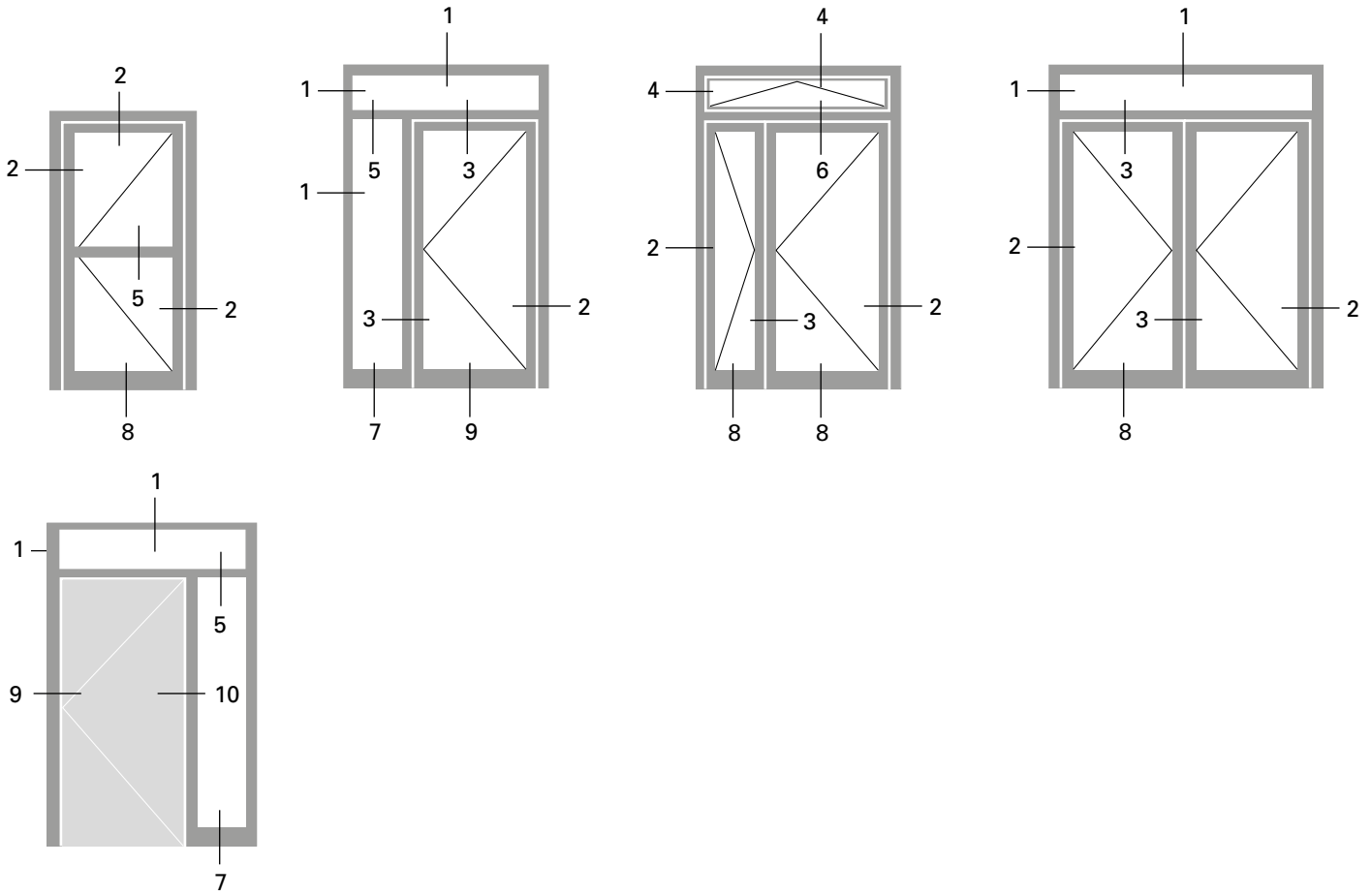

DXF **DWG** D-250-C-001

DXF **DWG** D-250-C-032

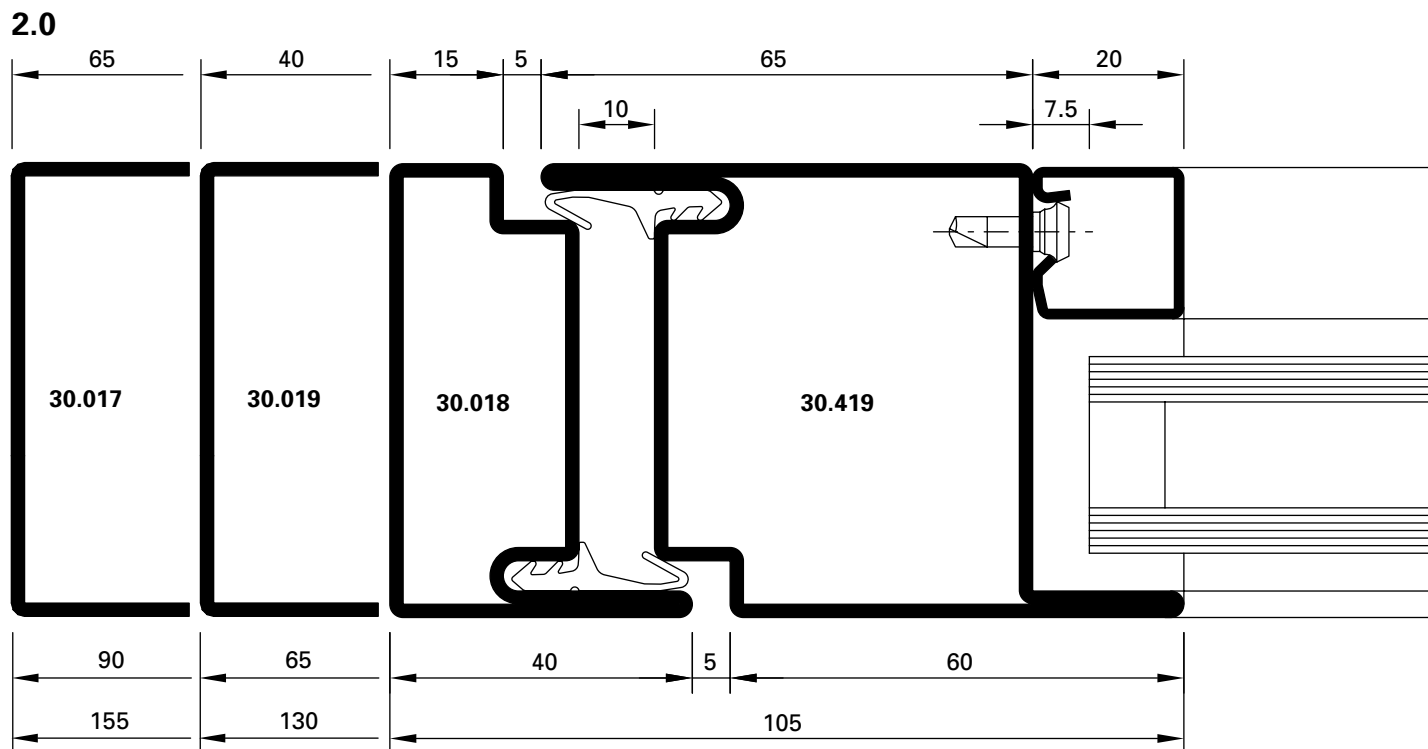

DXF DWG D-250-C-002

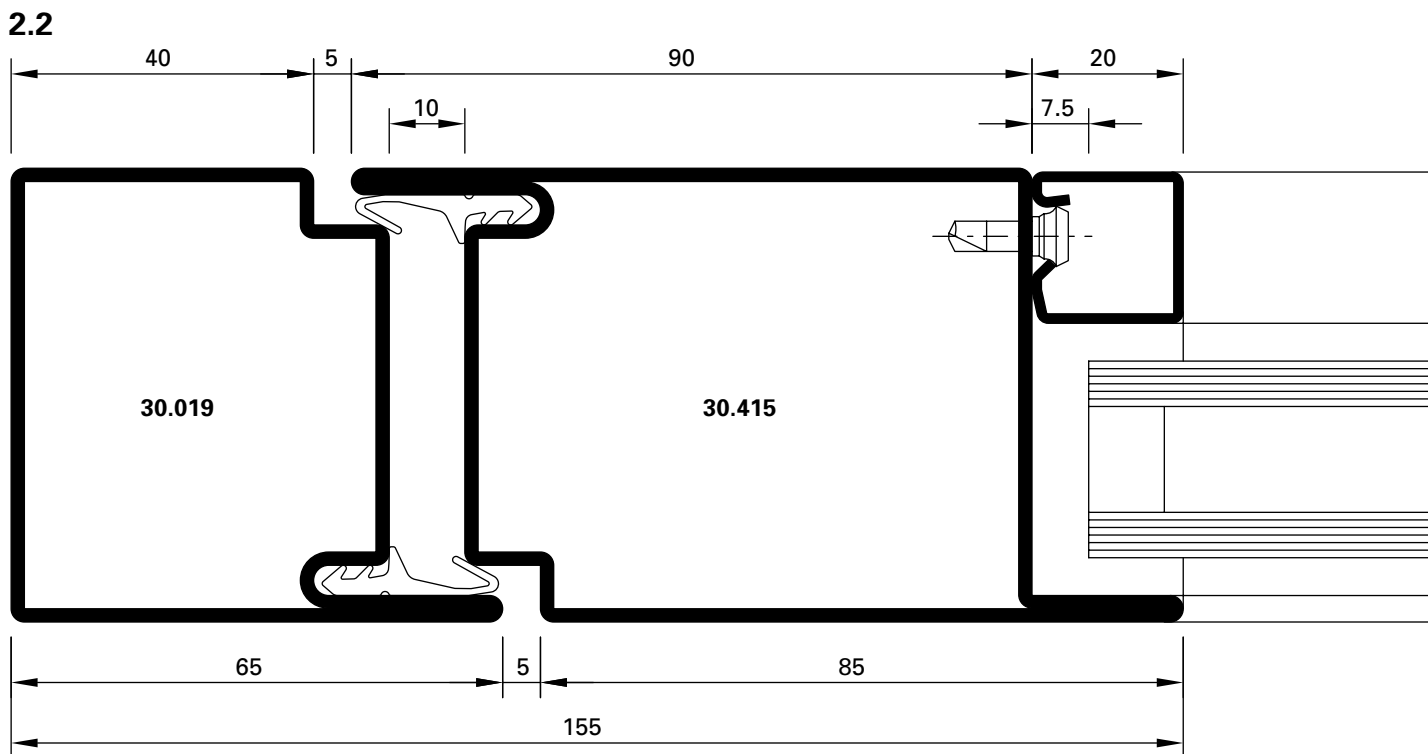

DXF DWG D-250-C-005

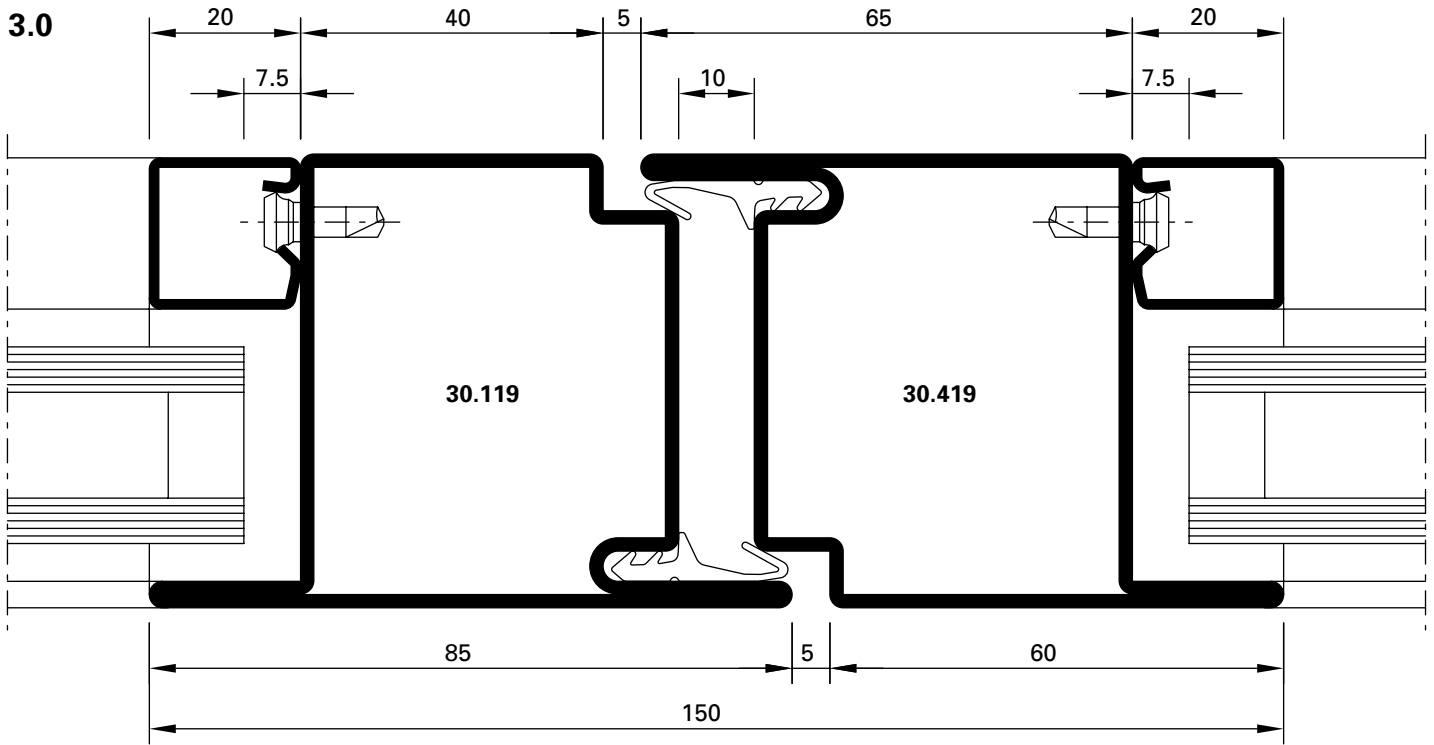

DXF DWG D-250-C-003

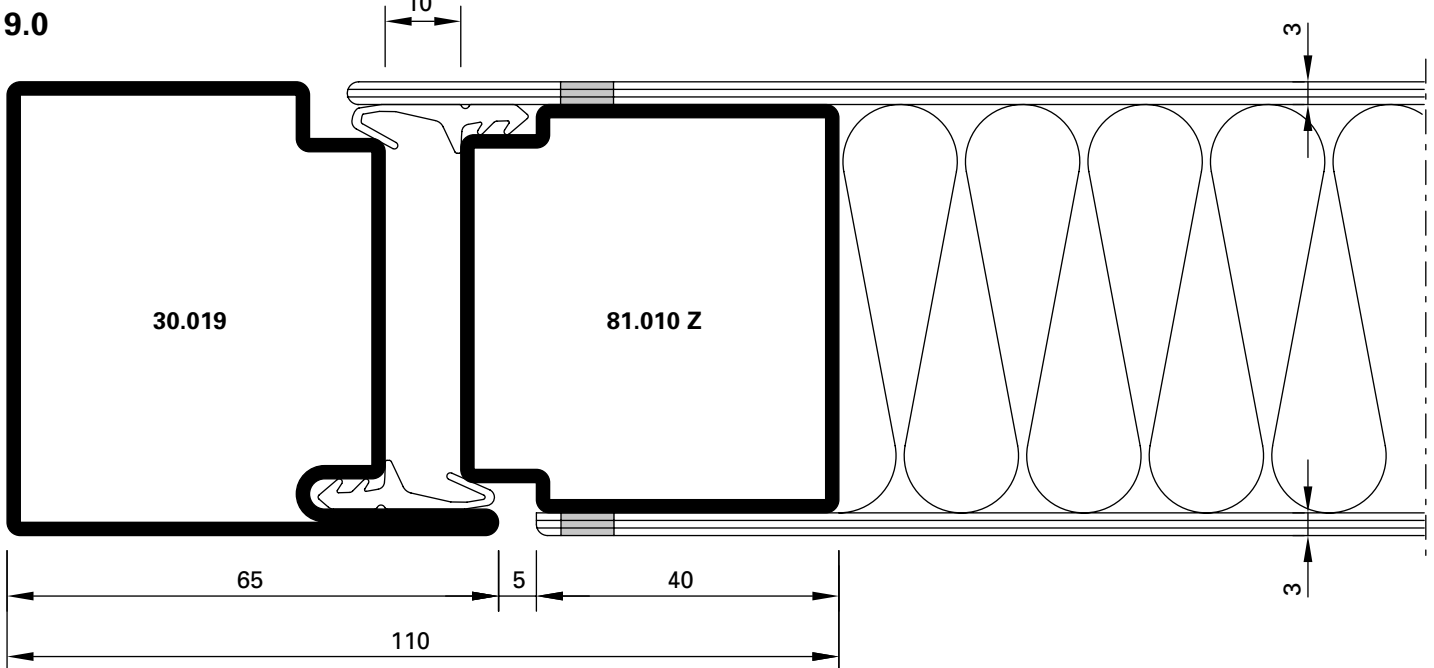

DXF DWG D-250-C-013

4.0

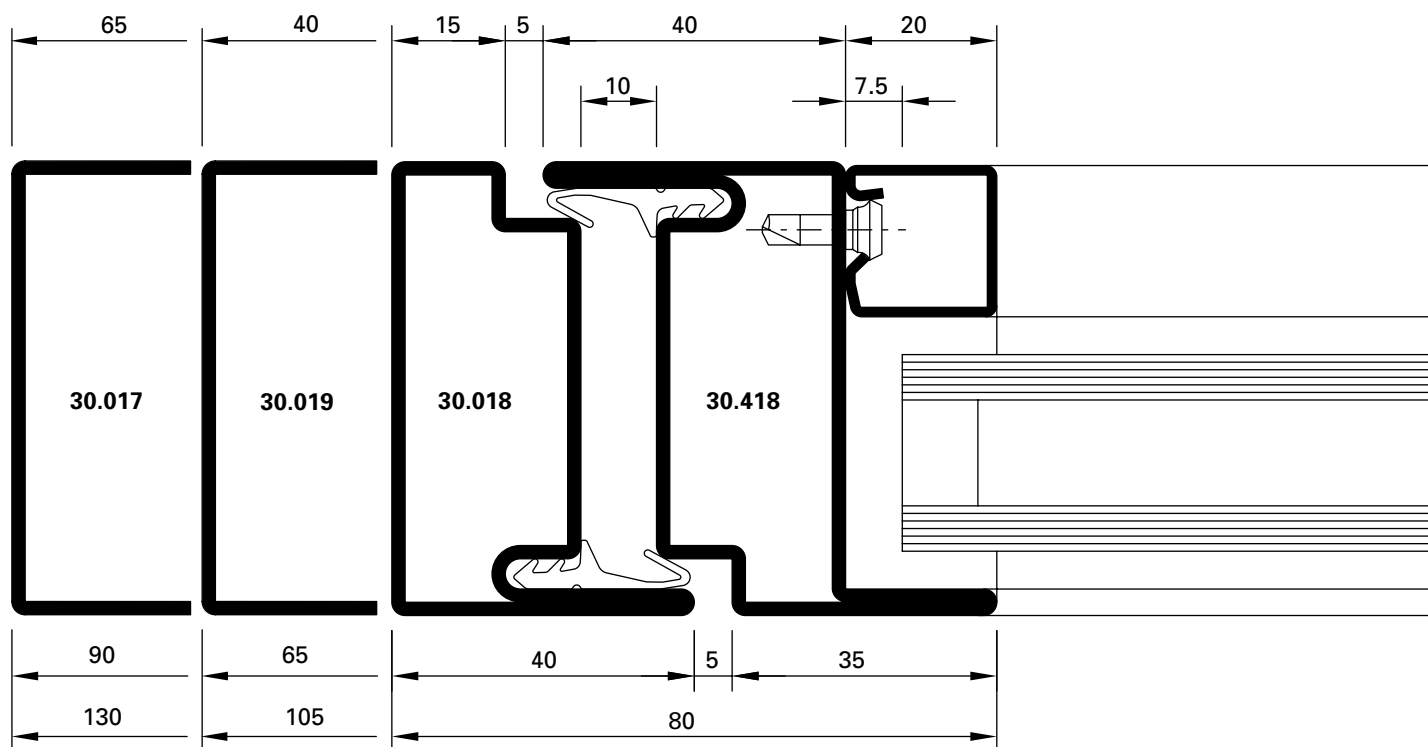

DXF **DWG** D-250-C-010

5.0

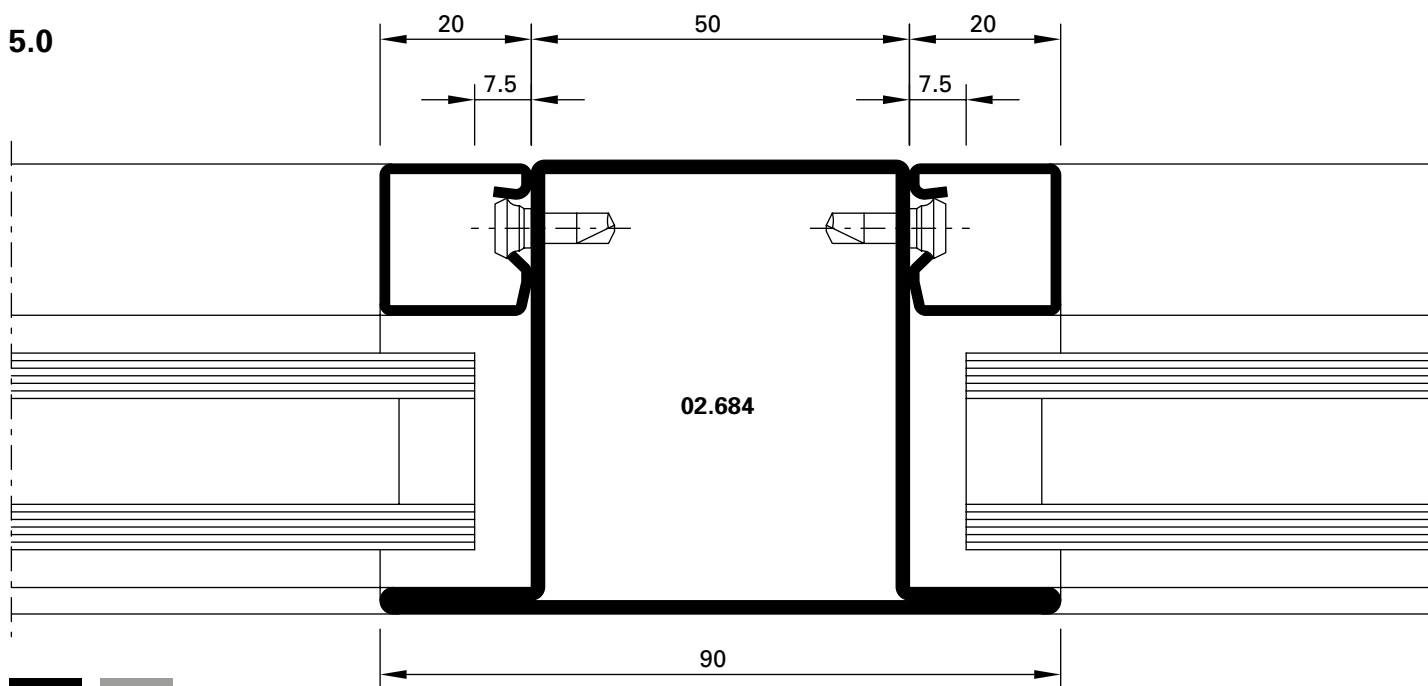

DXF **DWG** D-250-C-012

8.0

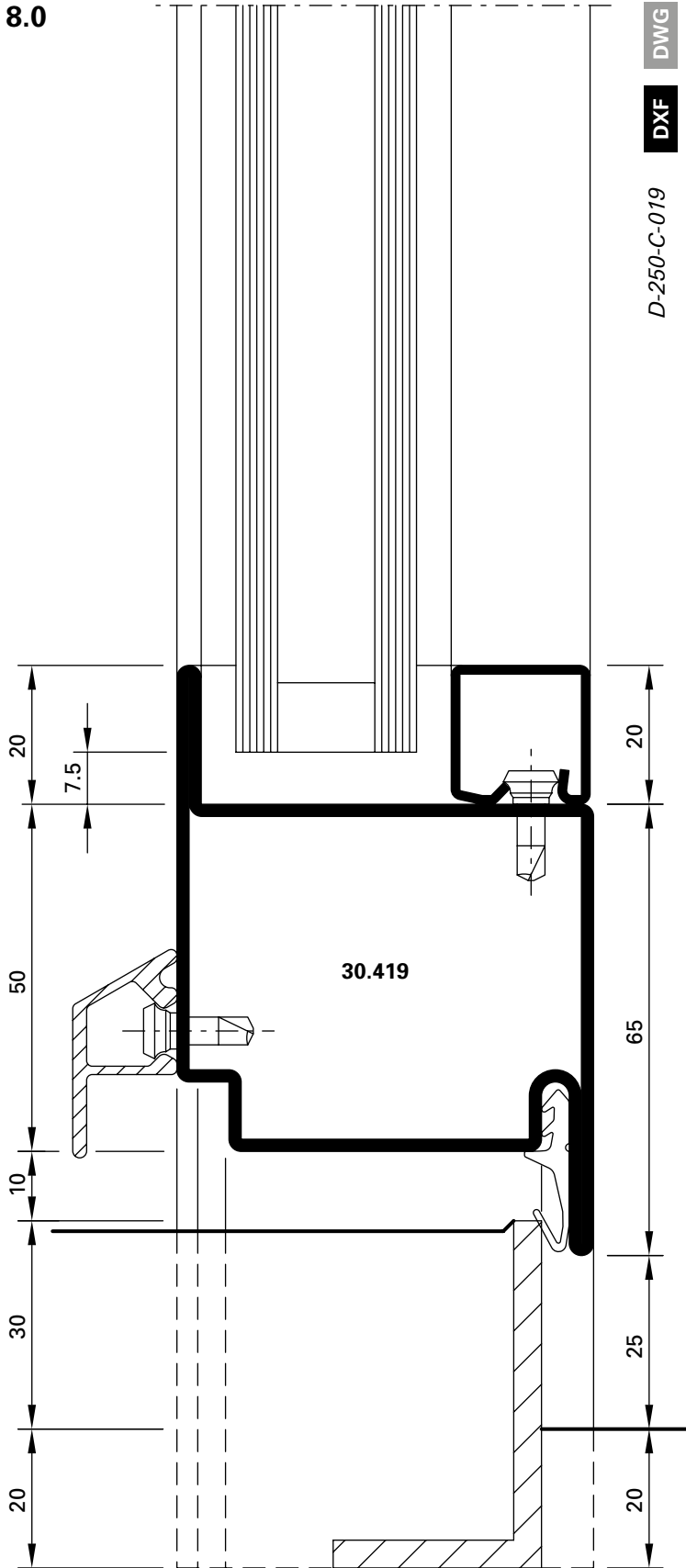

8.1

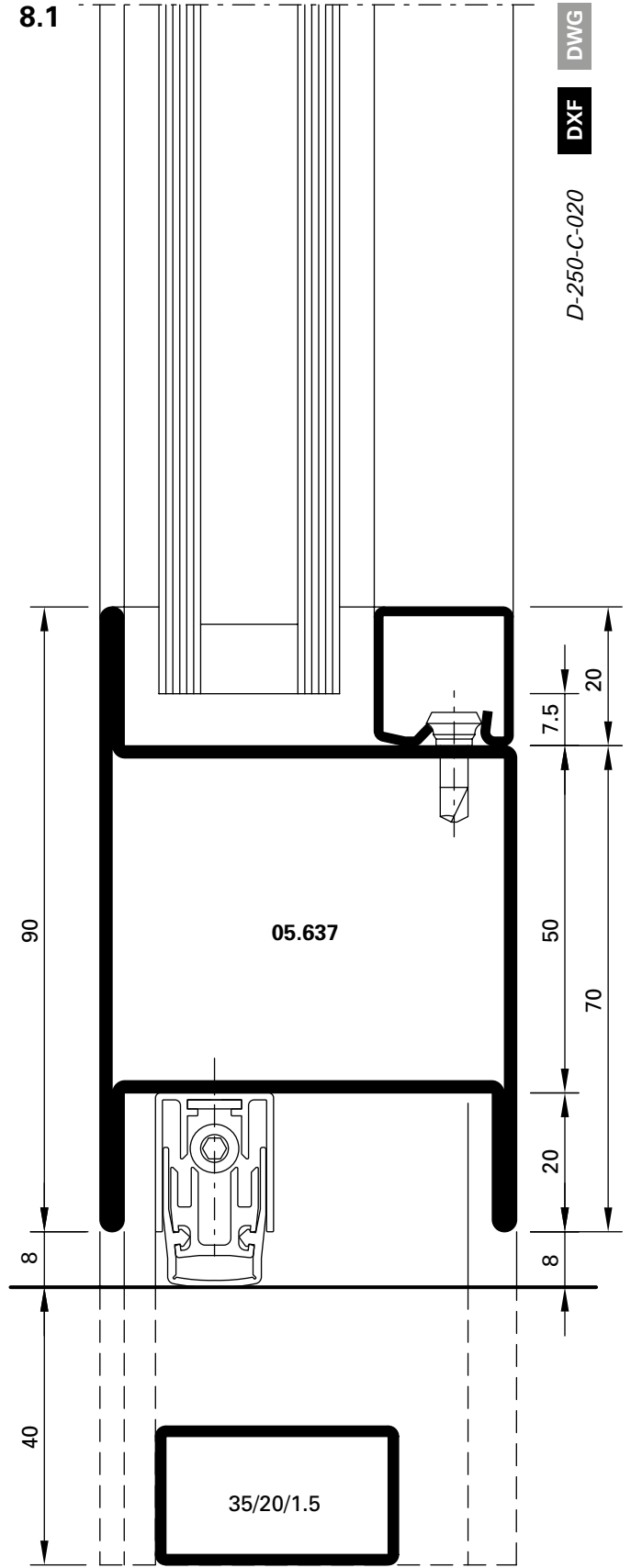

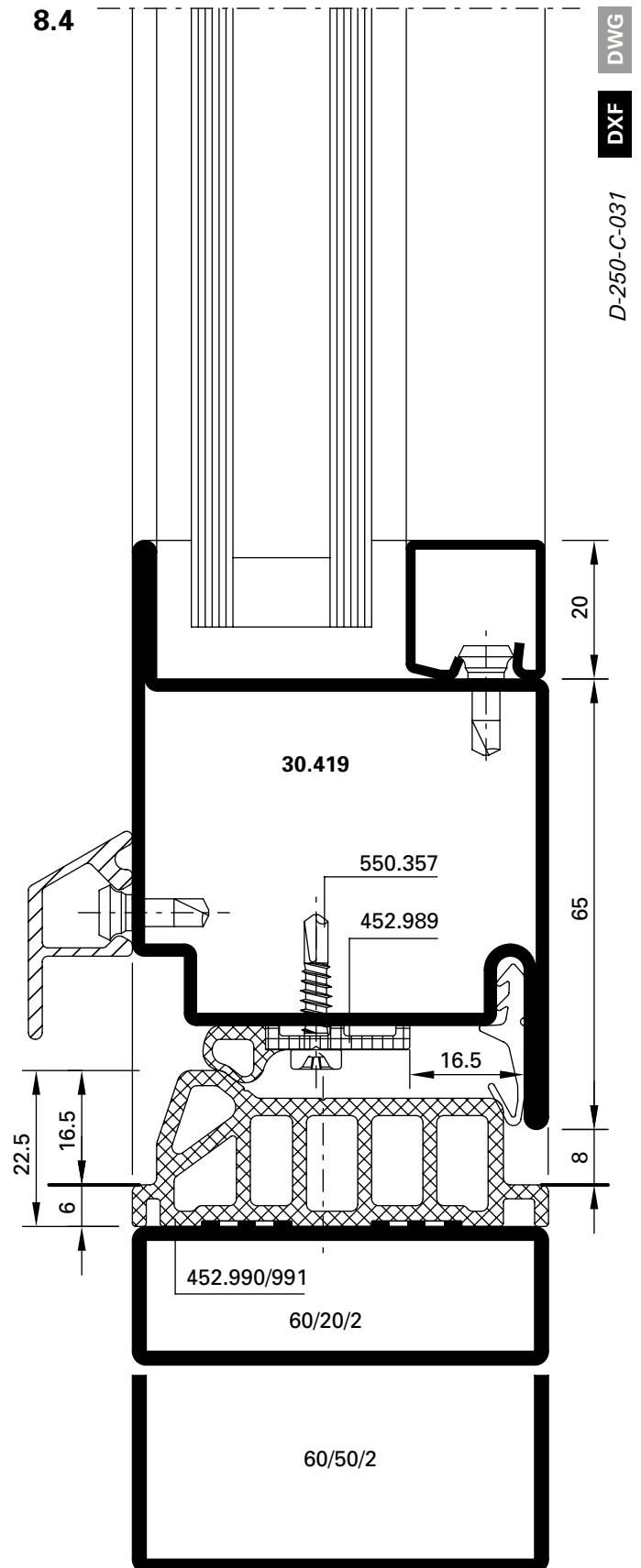
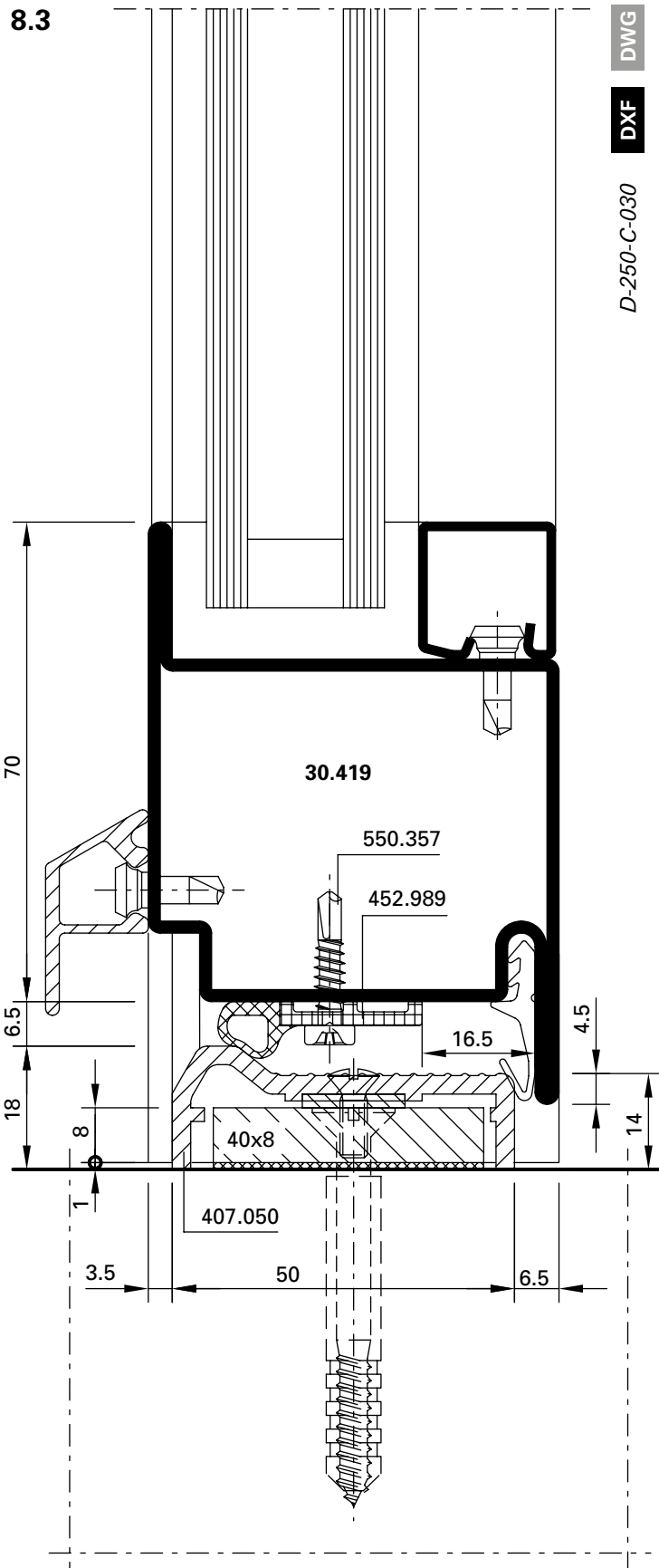

2.1

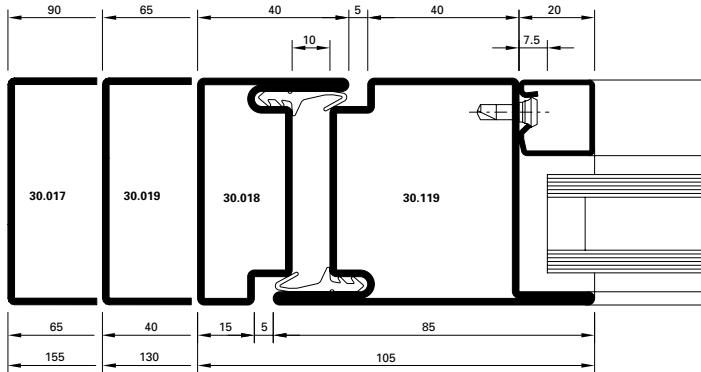

DXF **DWG** *D-250-C-004*

2.3

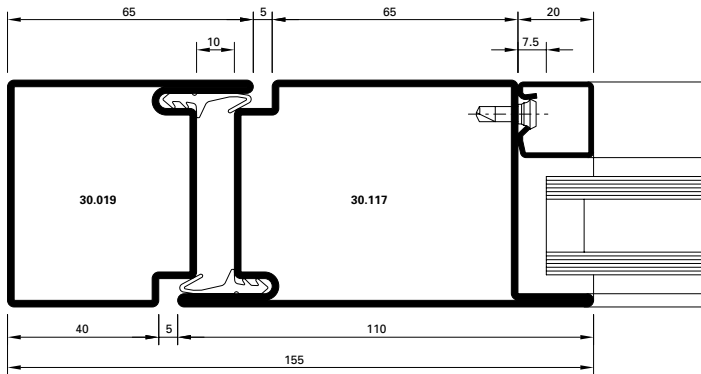

DXF **DWG** *D-250-C-006*

3.1

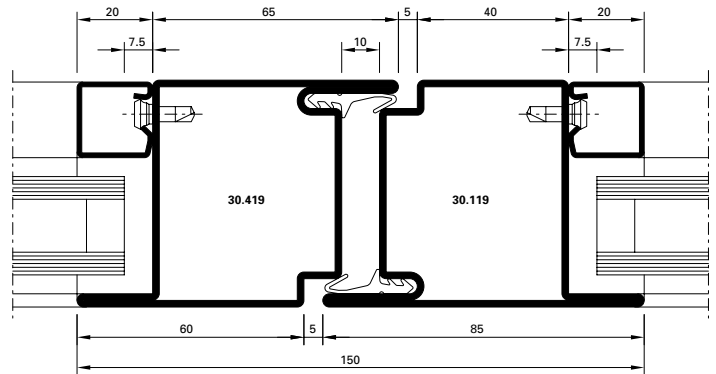

DXF **DWG** *D-250-C-007*

3.2

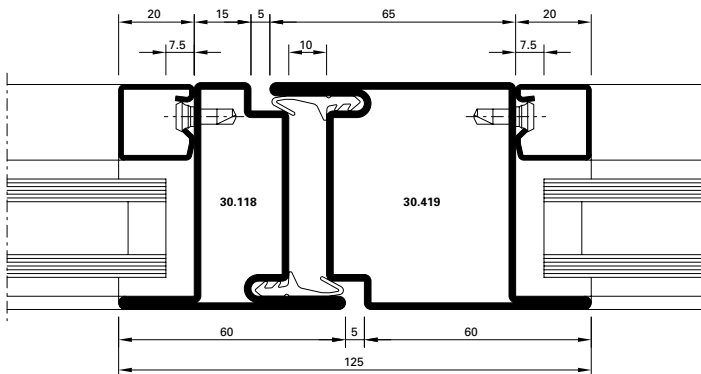

DXF **DWG** *D-250-C-008*

3.3

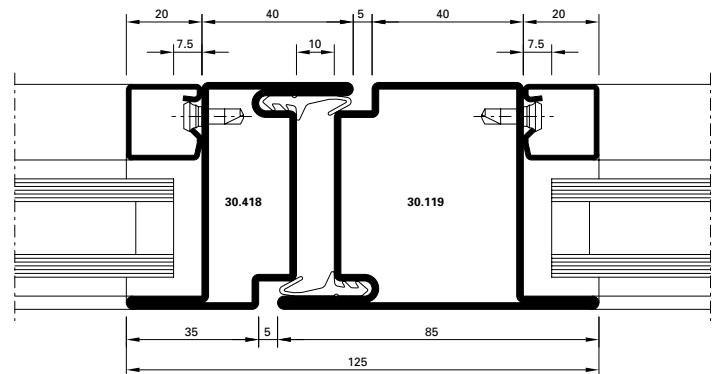

DXF **DWG** *D-250-C-009*

9.1

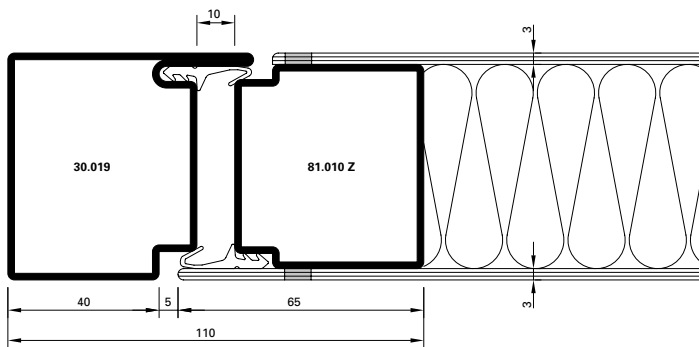

DXF **DWG** D-250-C-014

10.0

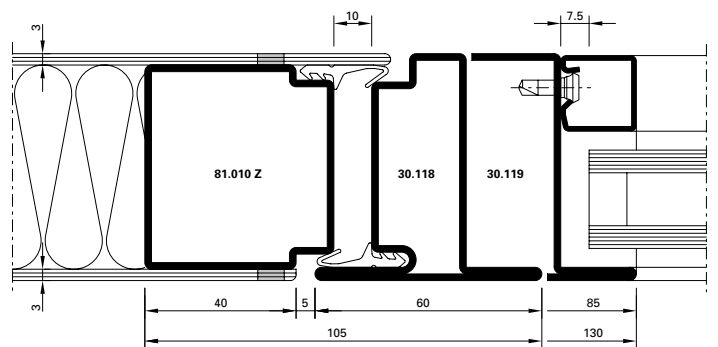

DXF **DWG** D-250-C-015

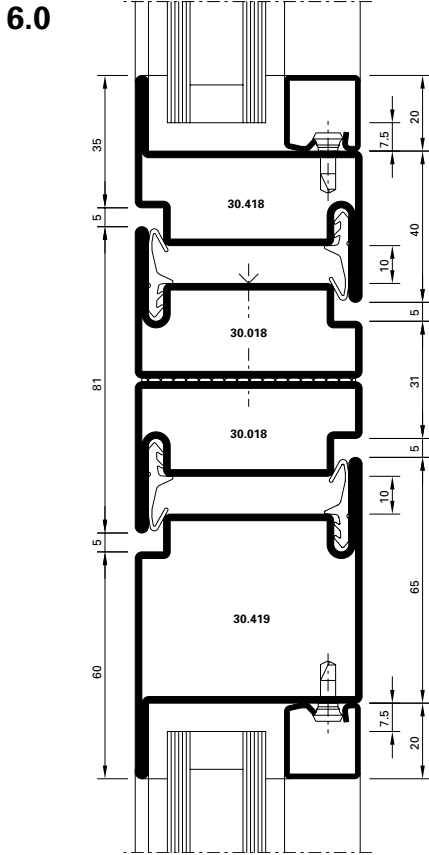

DWG
 DXF
 D-250-C-016

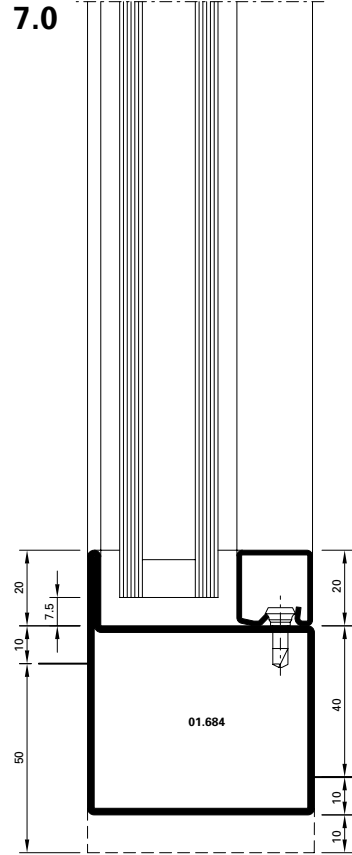

DWG
 DXF
 D-250-C-017

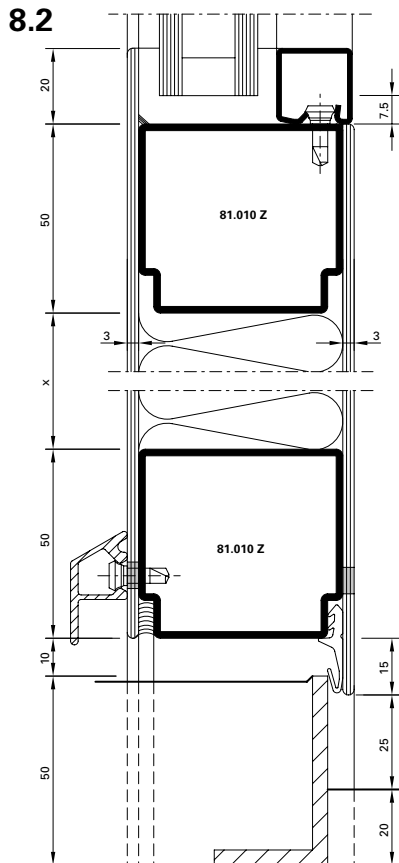

DWG
 DXF
 D-250-C-021

5.1

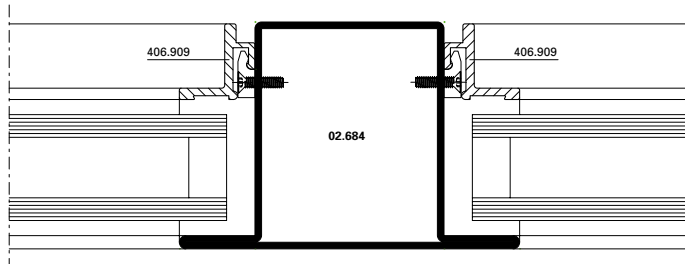

DXF **DWG** *D-250-C-022*

5.2

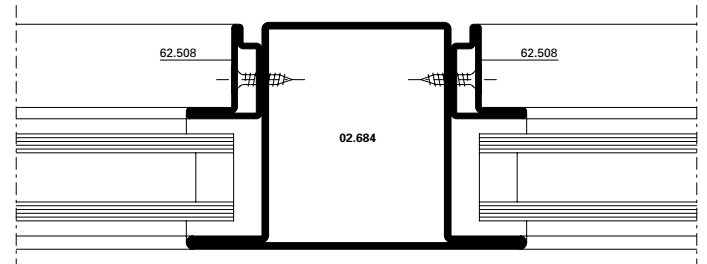

DXF **DWG** *D-250-C-023*

5.3

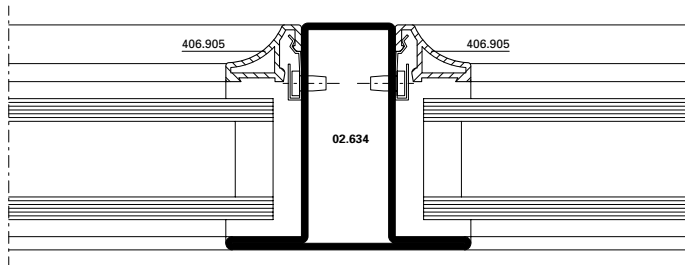

DXF **DWG** *D-250-C-024*

5.4

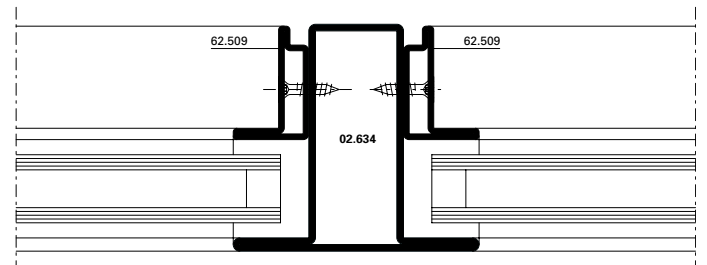

DXF **DWG** *D-250-C-025*

5.5

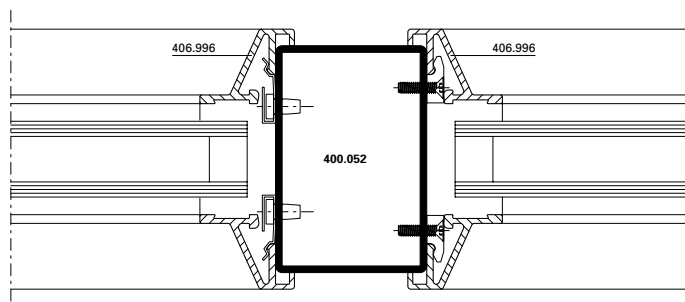

DXF **DWG** *D-250-C-026*

5.6

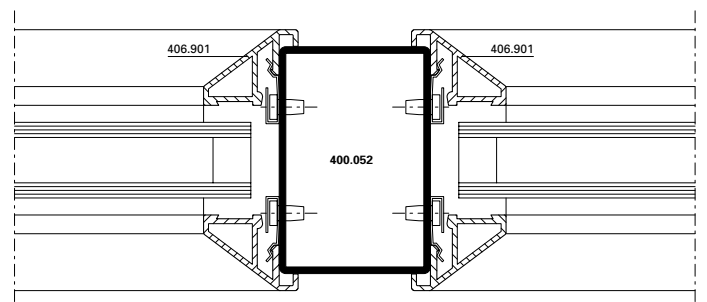

DXF **DWG** *D-250-C-027*

5.7

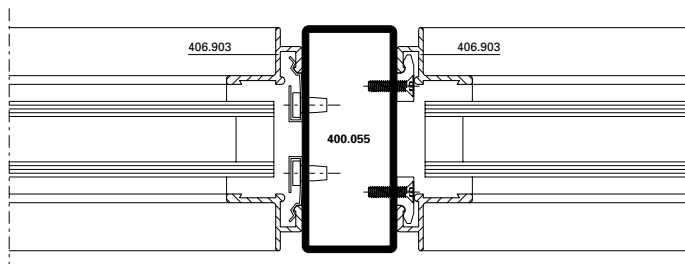

DXF **DWG** *D-250-C-028*

5.8

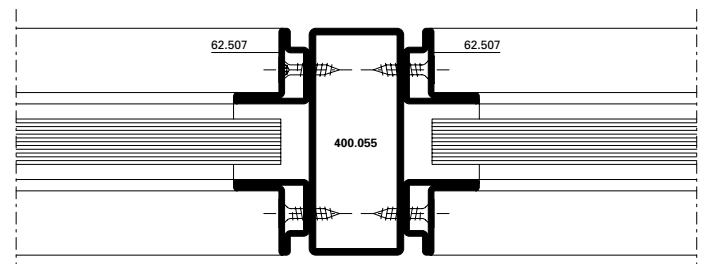

DXF **DWG** *D-250-C-029*

Schnittpunkte im Massstab 1:1
Coupe de détails à l'échelle 1:1
Section details on scale 1:1

Jansen-Economy 60 Türen
Jansen-Economy 60 portes
Jansen-Economy 60 doors

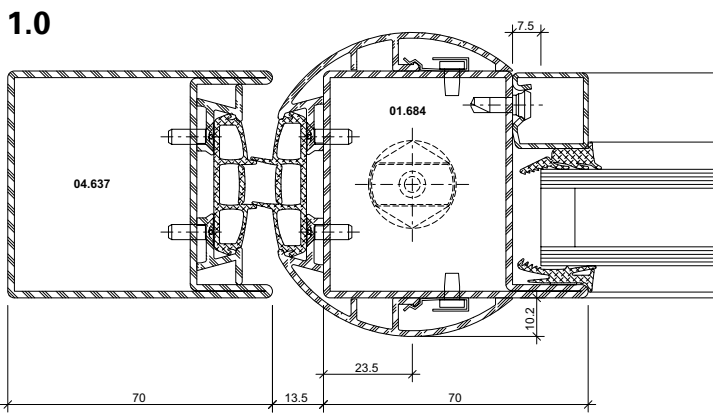
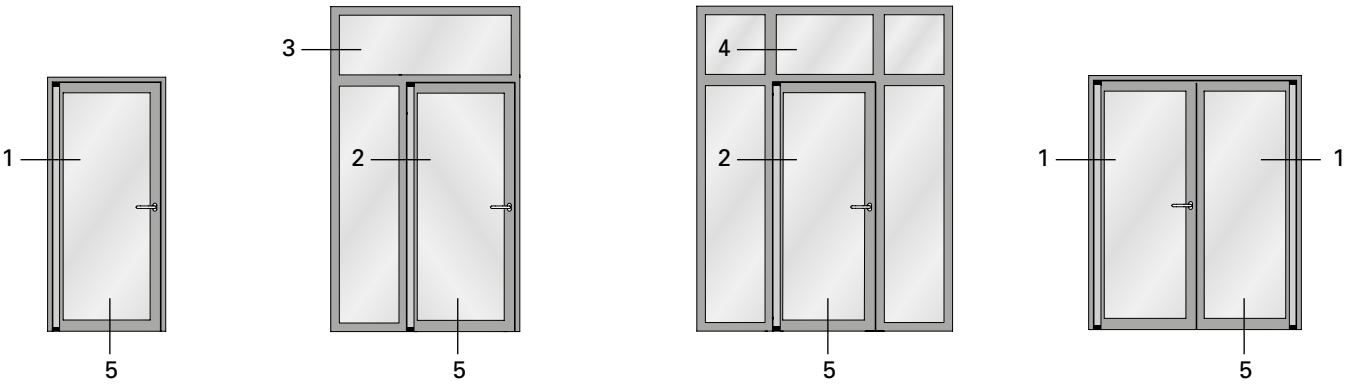

DXF **DWG** 22-0103-C-001

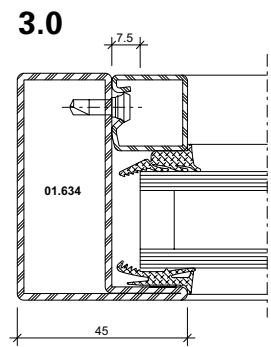

22-0101-C-001
DXF **DWG**

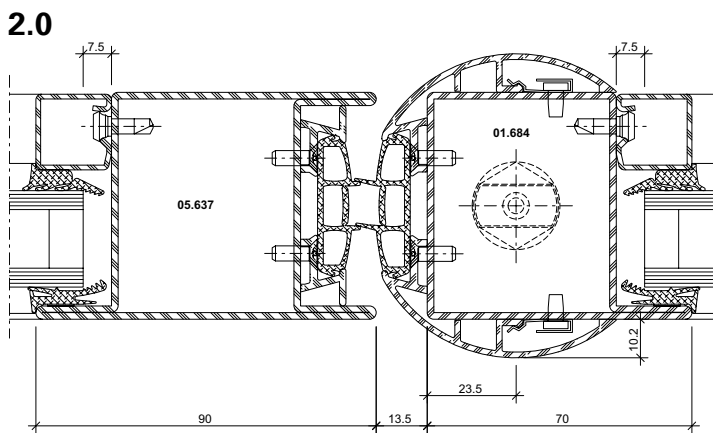

DXF **DWG** 22-0103-C-002

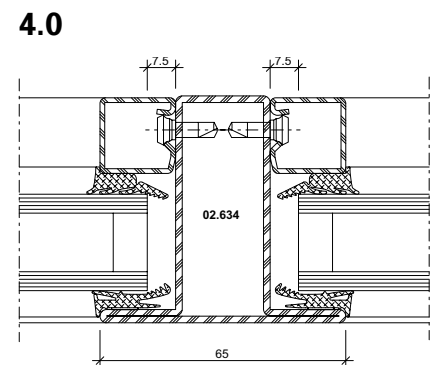

22-0101-C-002
DXF **DWG**

5.0

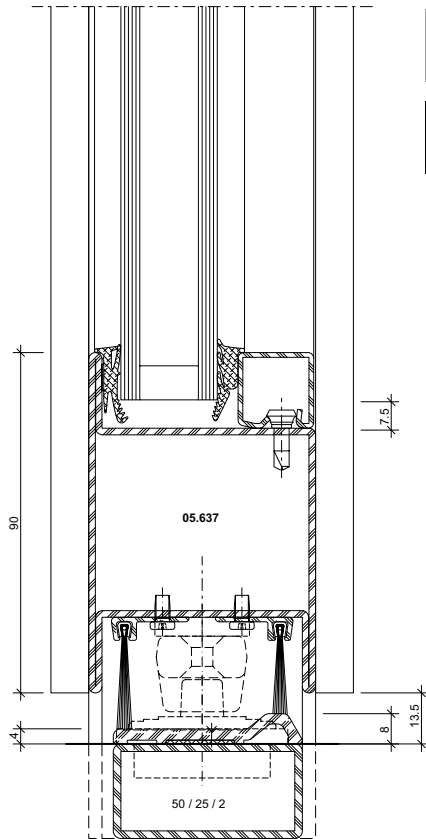

DWG

DXF

22-0103-C-003

5.1

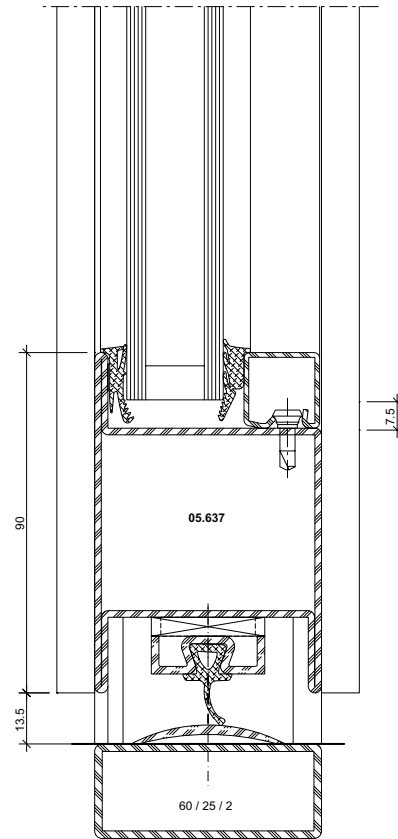

DWG

DXF

22-0103-C-009

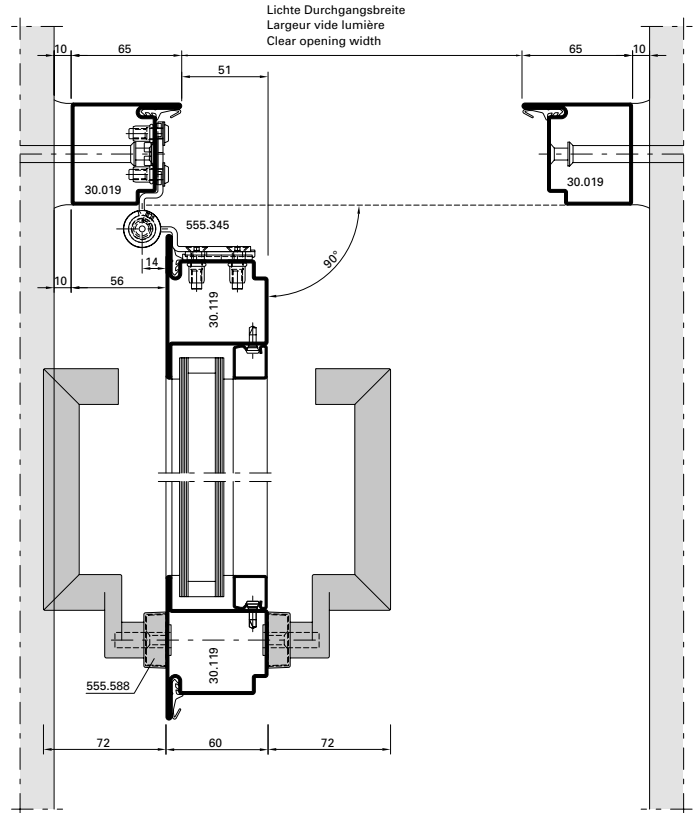
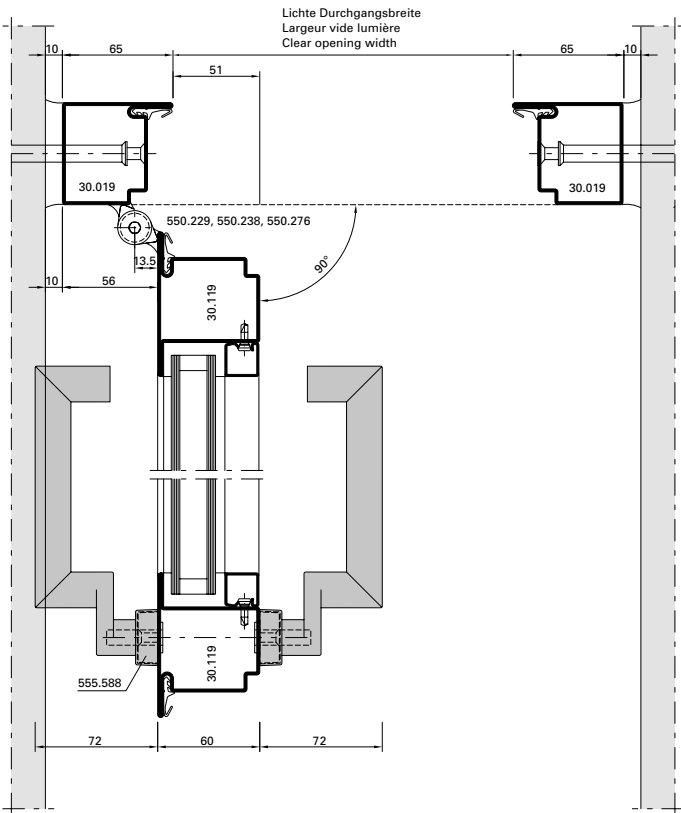

DXF **DWG** *D-250-E-016*

DXF **DWG** *D-250-E-018*

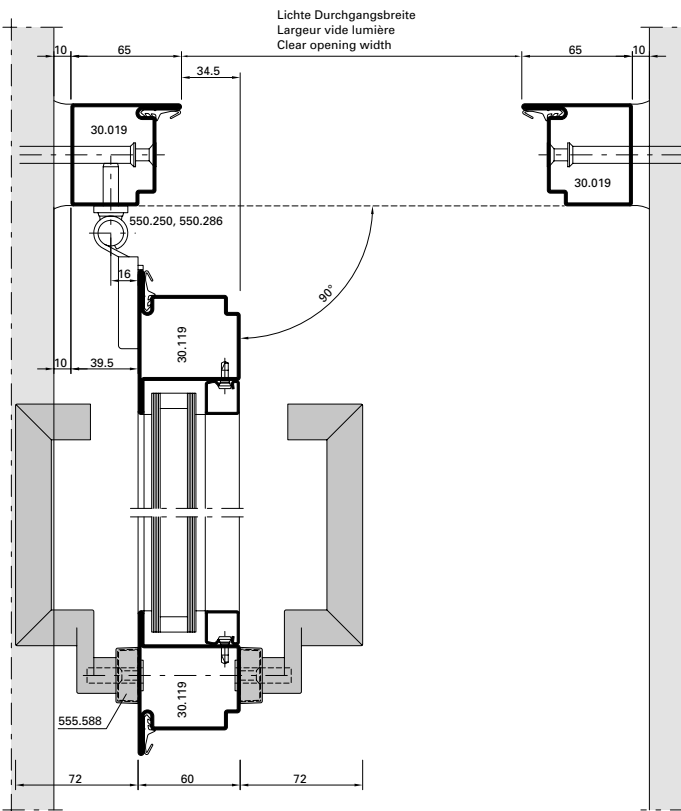

DXF **DWG** *D-250-E-020*

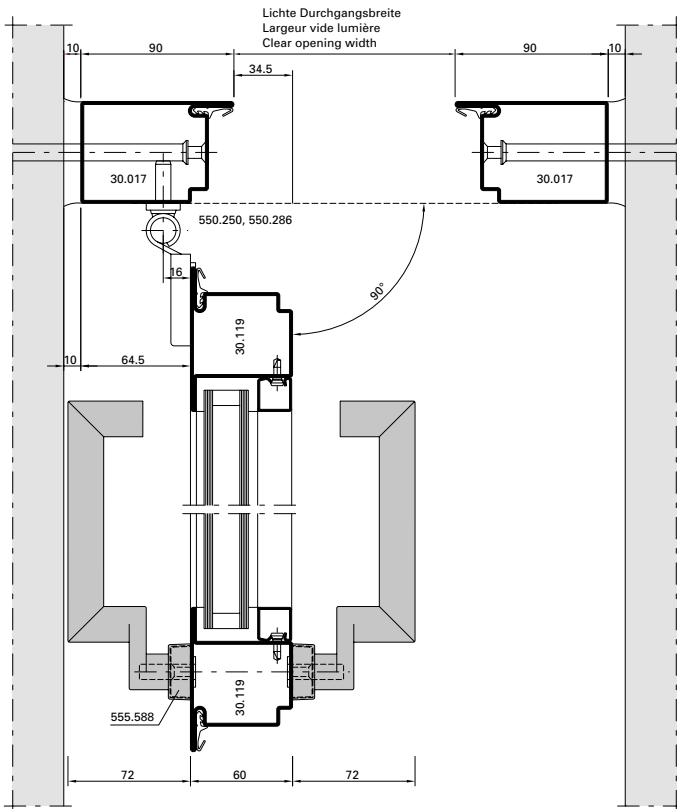

DXF **DWG** *D-250-E-021*

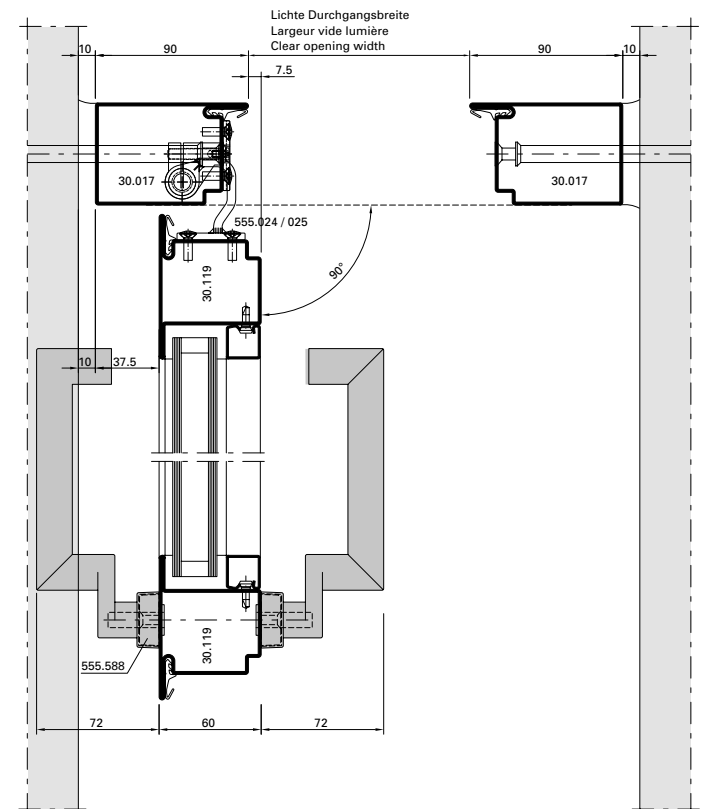

DXF **DWG** *D-250-E-025*

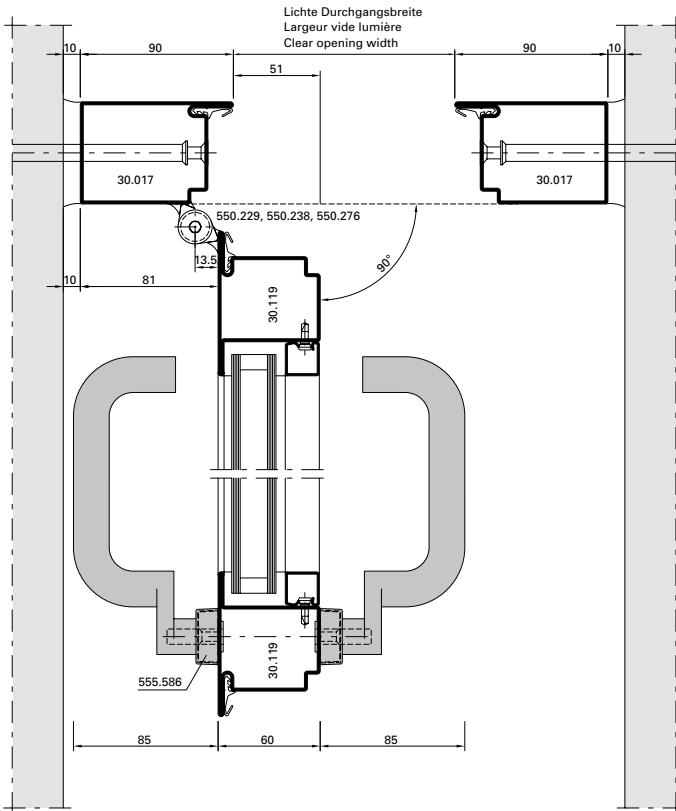

DXF **DWG** *D-250-E-017*

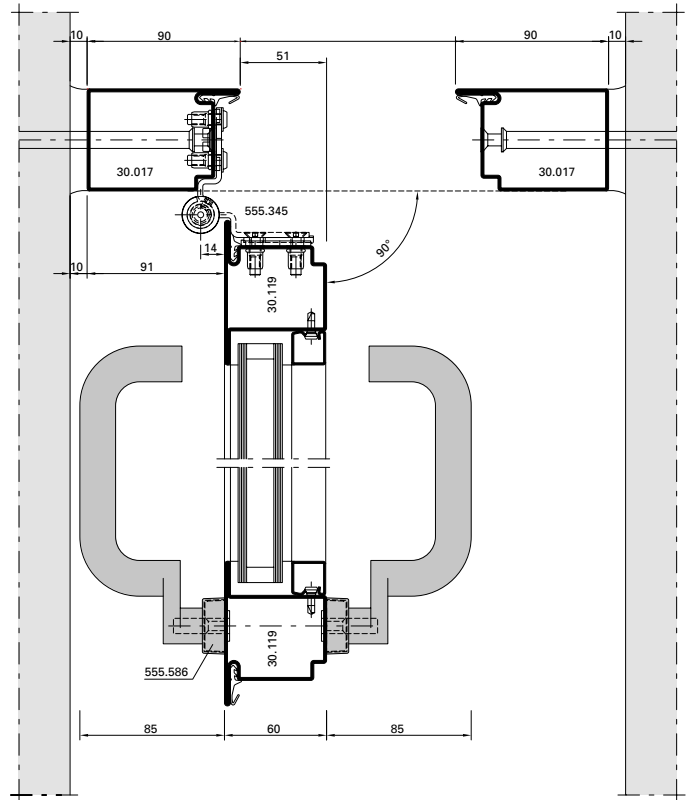

DXF **DWG** *D-250-E-019*

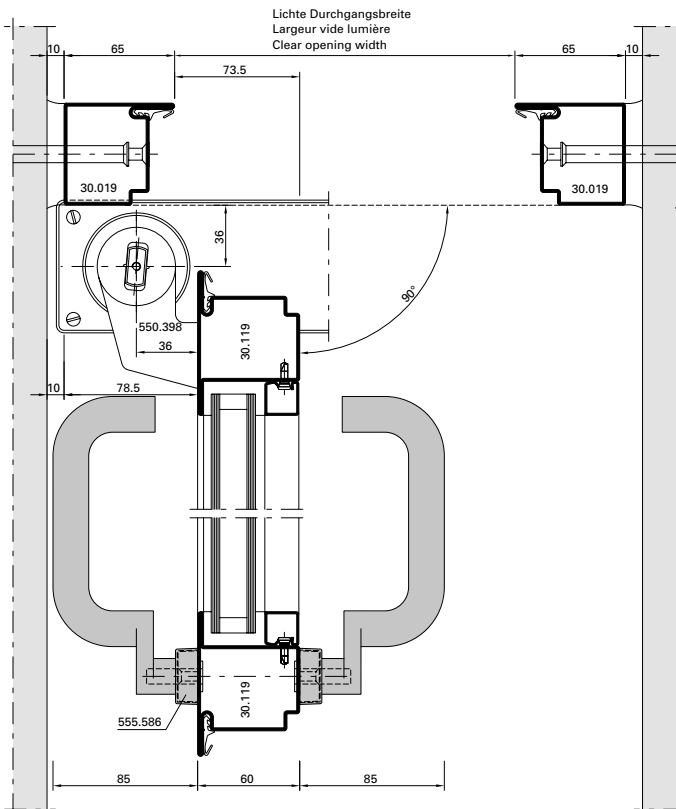

DXF **DWG** *D-250-E-022*

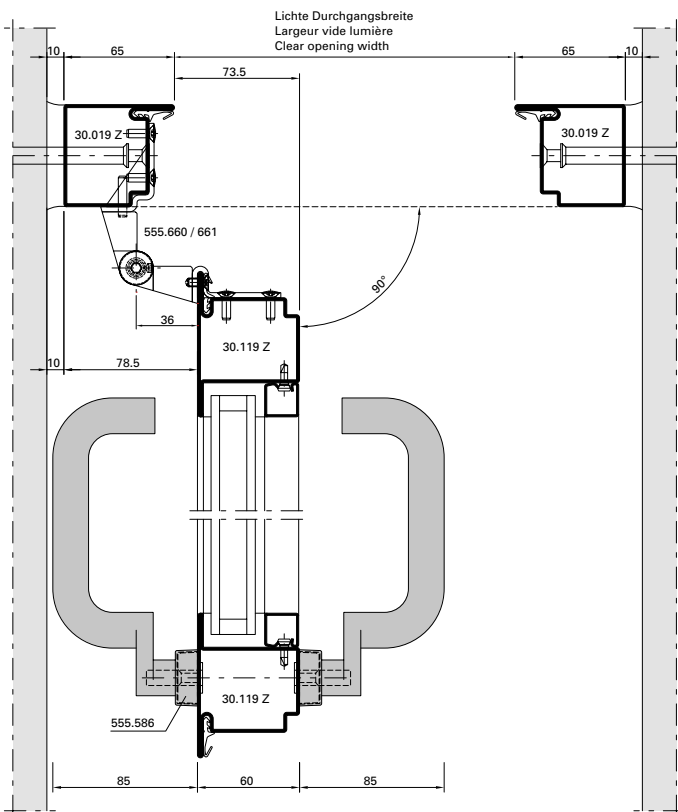

DXF **DWG** *D-250-E-023*

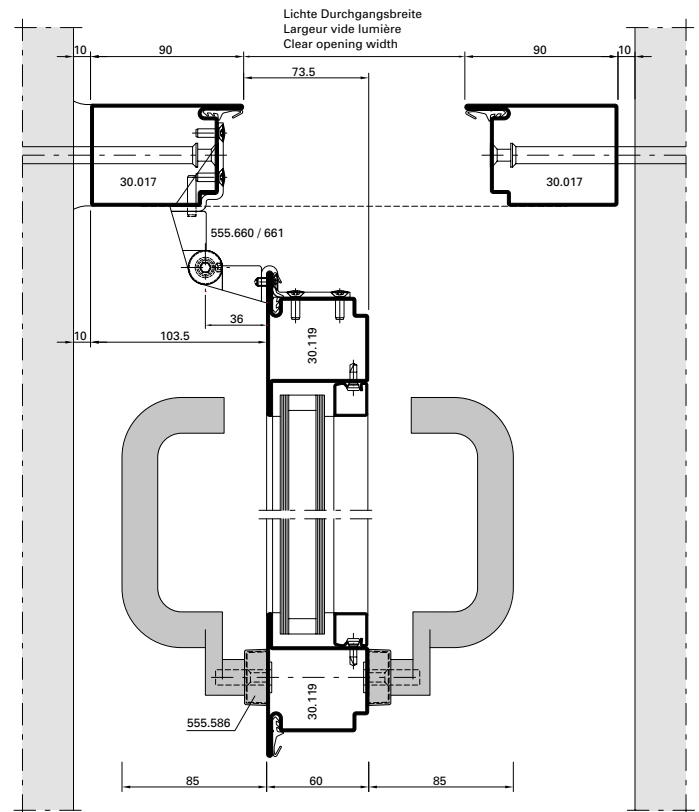

DXF **DWG** *D-250-E-024*

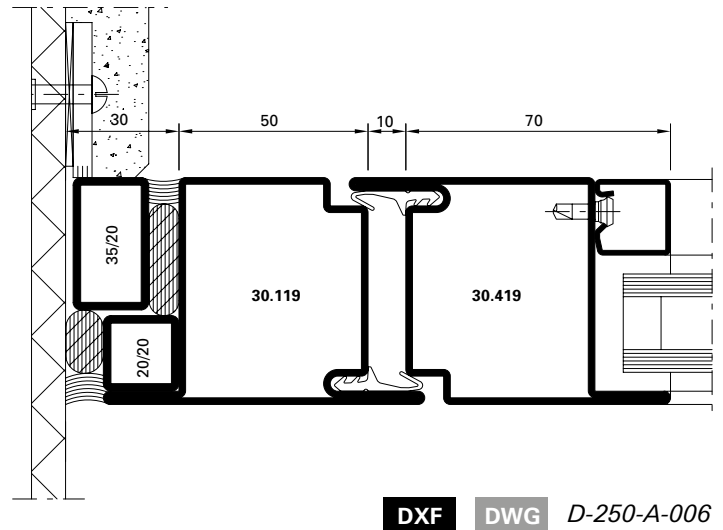
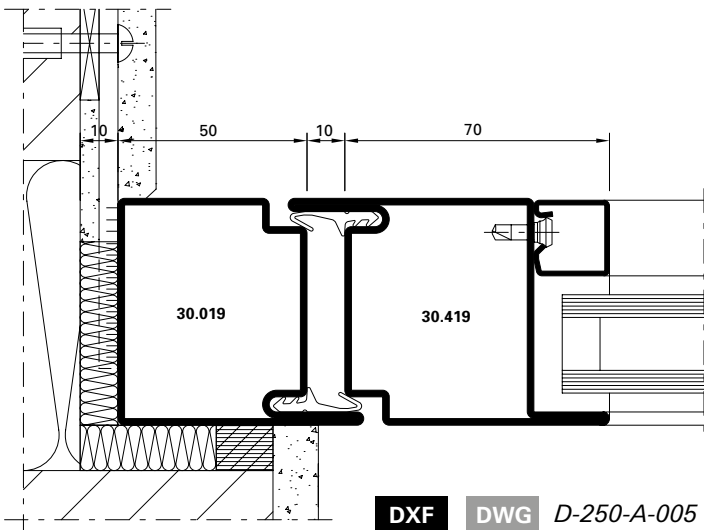
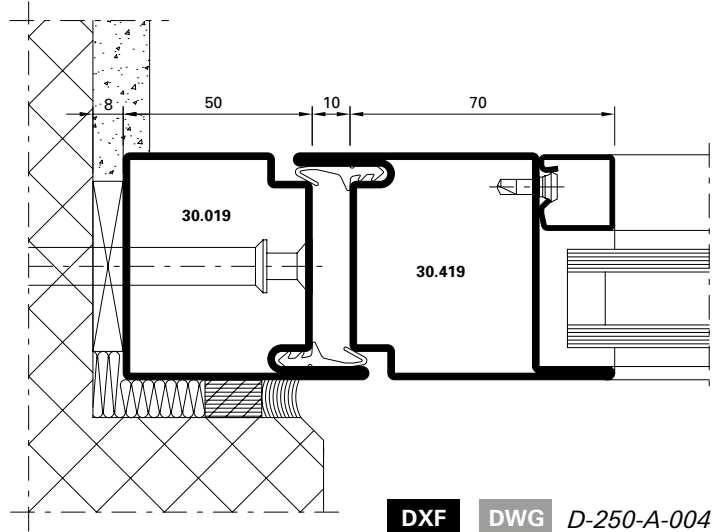
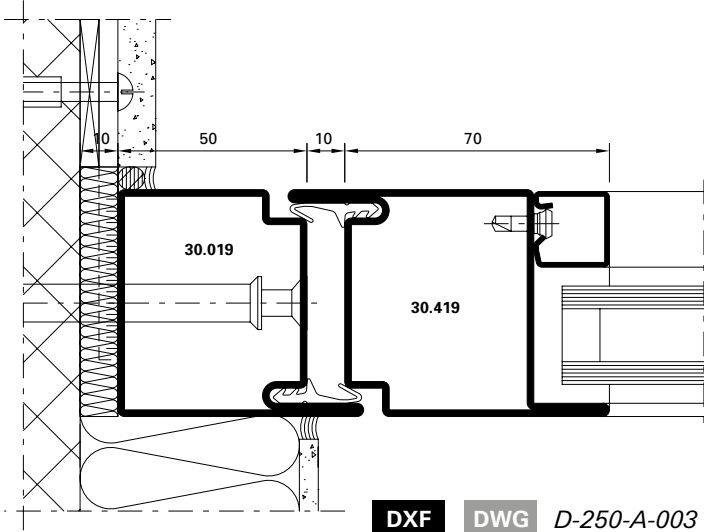
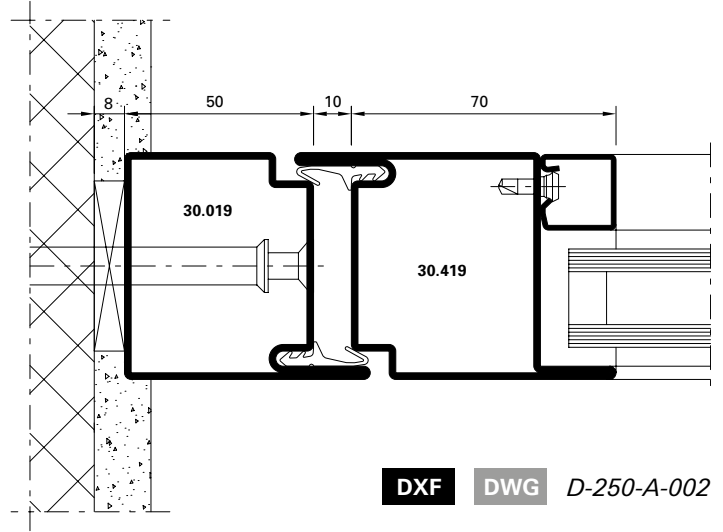
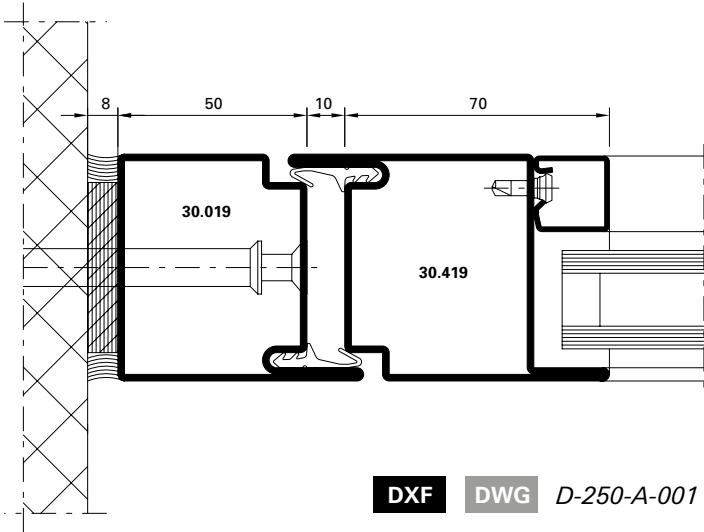

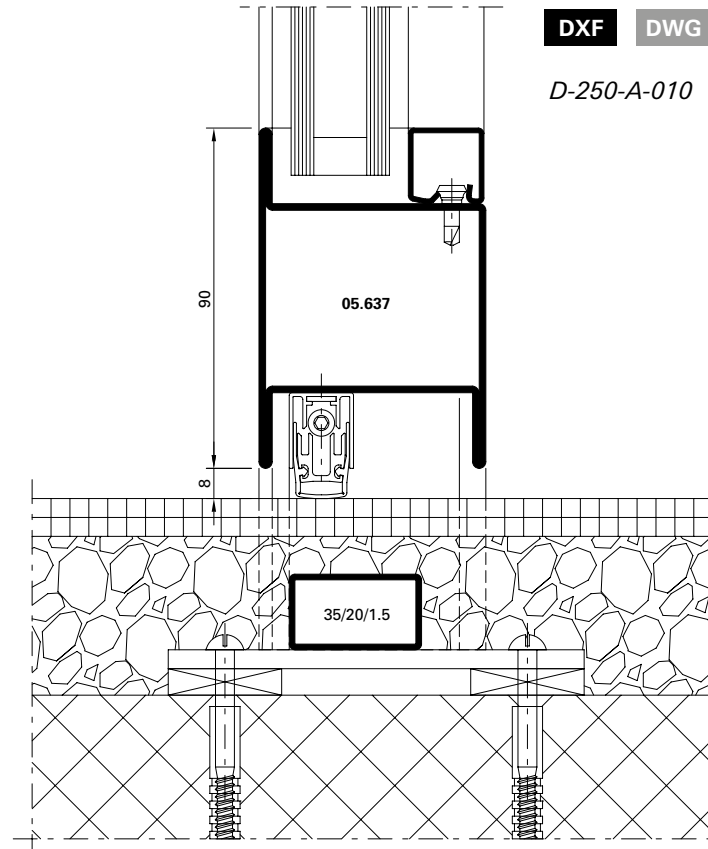
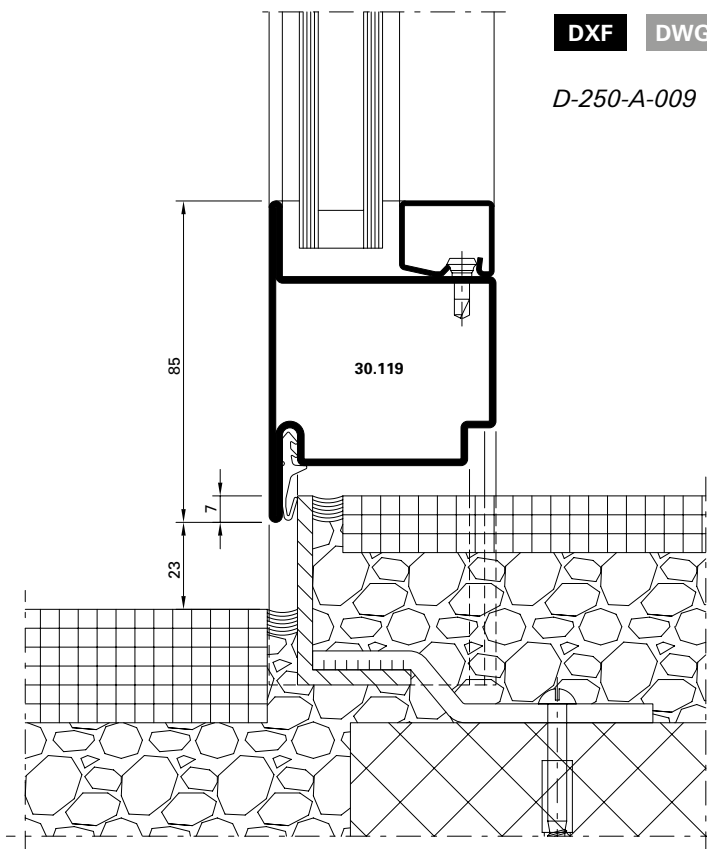
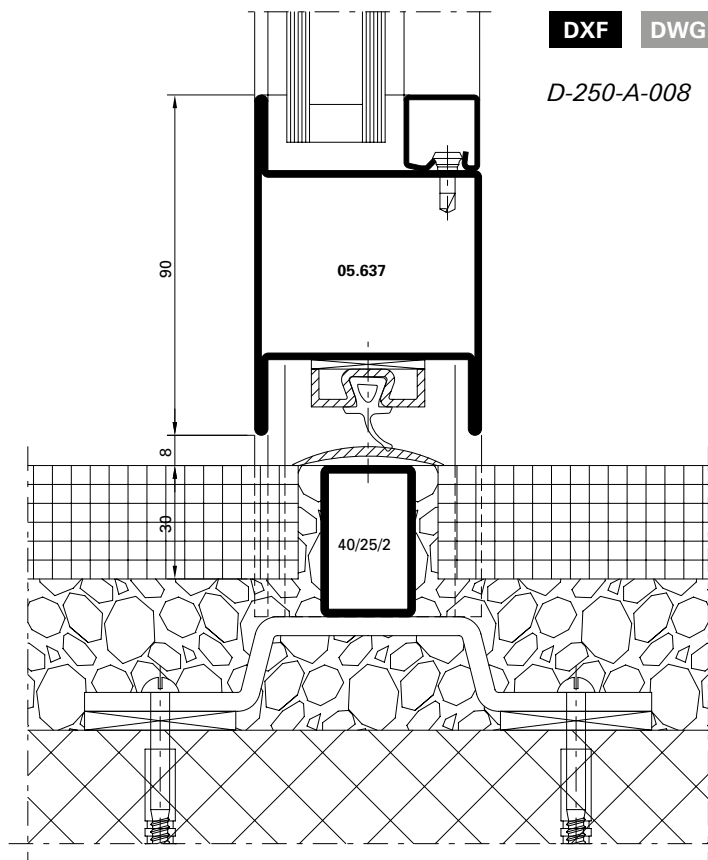
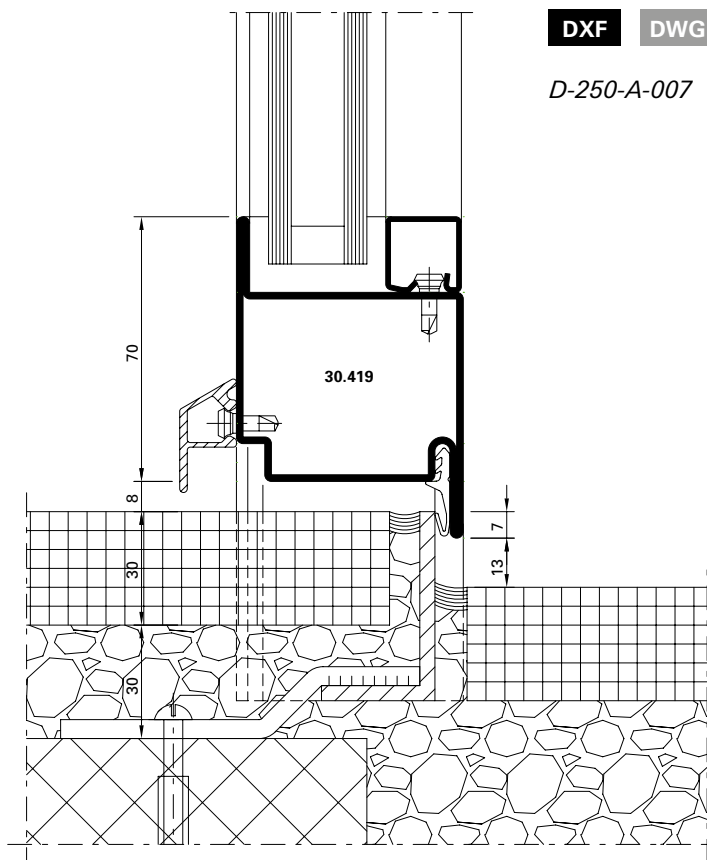



Einflügelige Türen,
 auswärts öffnend,
 Flügelhöhe ≤ 2200 mm

Porte à un vantail,
 ouvrant vers l'extérieur,
 hauteur du vantail ≤ 2200 mm

Single leaf door,
 outward opening,
 leaf height ≤ 2200 mm

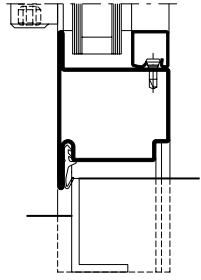
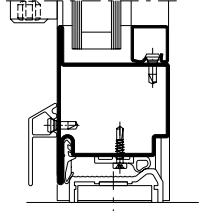
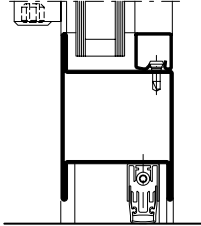
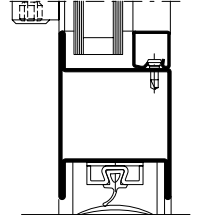
Variante	Beschlag Ferrure Fitting	 EN 12207	 EN 12208	 EN 12210
Anschlagdichtung Joint de butée Rebate gasket 	1	2	1A	C4
	2	2	2A	C4
	3	3	2A	C5
Doppel-Anschlagdichtung Joint de base double Double rebate gasket 	1	4	3A	C4
	2	4	3A	C4
	3	4	5A	C5
Senkdichtung Joint seuil Drop seal 	1	2	1A	C4
	2	2	2A	C4
	3	3	2A	C5
Auflaufdichtung Joint de contact Ramp seal 	1	2	0	C4
	2	2	0	C4
	3	2	0	C5

1 Fallenriegel-Schloss
 Serrure à mortaiser
 Latch and bolt lock





2 Schloss mit Obenverriegelung
 Serrure avec verrouillage supérieur
 Lock with top locking point

3 Mehrfachverriegelungs-Schloss
 Serrure à verrouillage multiple
 Multipoint lock

Einflügelige Türen,
 einwärts öffnend,
 Flügelhöhe ≤ 2200 mm

Porte à un vantail,
 ouvrant vers l'intérieur,
 hauteur du vantail ≤ 2200 mm

Single leaf door,
 inward opening,
 leaf height ≤ 2200 mm

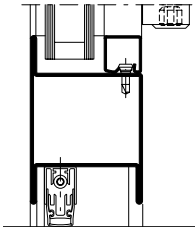
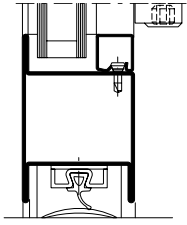
Variante		Beschlag Ferrure Fitting	 EN 12207	 EN 12208	 EN 12210
Senkdichtung Joint seuil Drop seal		①	2	0	C4
		②	2	0	C4
		③	3	1A	C5
Auflaufdichtung Joint de contact Ramp seal		①	2	0	C4
		②	2	0	C4
		③	2	0	C5

① Fallenriegel-Schloss
 Serrure à mortaiser
 Latch and bolt lock



② Schloss mit Obenverriegelung
 Serrure avec verrouillage supérieur
 Lock with top locking point

③ Mehrfachverriegelungs-Schloss
 Serrure à verrouillage multiple
 Multipoint lock

Einflügelige Türen,
 auswärts öffnend,
 Flügelhöhe ≤ 3000 mm

Porte à un vantail,
 ouvrant vers l'extérieur,
 hauteur du vantail ≤ 3000 mm

Single leaf door,
 outward opening,
 leaf height ≤ 3000 mm

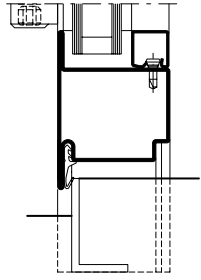
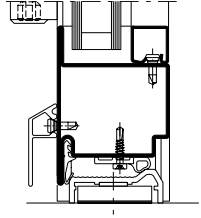
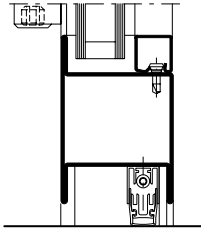
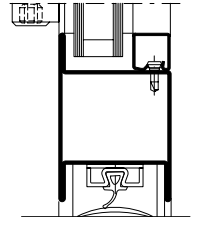
Variante	Beschlag Ferrure Fitting	 EN 12207	 EN 12208	 EN 12210
Anschlagdichtung Joint de butée Rebate gasket 	1	1	0	C1
	2	1	0	C1
	3	1	0	C2
Doppel-Anschlagdichtung Joint de base double Double rebate gasket 	1	1	1A	C1
	2	1	1A	C1
	3	2	2A	C2
Senkdichtung Joint seuil Drop seal 	1	1	0	C1
	2	1	0	C1
	3	1	0	C2
Aufbaudichtung Joint de contact Ramp seal 	1	0	0	C1
	2	0	0	C1
	3	1	0	C2

1 Fallenriegel-Schloss
 Serrure à mortaiser
 Latch and bolt lock





2 Schloss mit Obenverriegelung
 Serrure avec verrouillage supérieur
 Lock with top locking point

3 Mehrfachverriegelungs-Schloss
 Serrure à verrouillage multiple
 Multipoint lock

Einflügelige Türen,
 einwärts öffnend,
 Flügelhöhe ≤ 3000 mm

Porte à un vantail,
 ouvrant vers l'intérieur,
 hauteur du vantail ≤ 3000 mm

Single leaf door,
 inward opening,
 leaf height ≤ 3000 mm

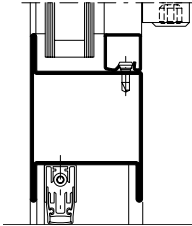
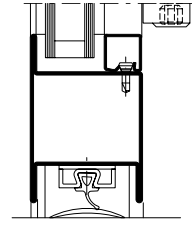
Variante		Beschlag Ferrure Fitting	 EN 12207	 EN 12208	 EN 12210
Senkdichtung Joint seuil Drop seal		❶	1	0	C1
		❷	1	0	C1
		❸	1	0	C2
Auflaufdichtung Joint de contact Ramp seal		❶	0	0	C1
		❷	0	0	C1
		❸	1	0	C2

❶ Fallenriegel-Schloss
 Serrure à mortaiser
 Latch and bolt lock



❷ Schloss mit Obenverriegelung
 Serrure avec verrouillage supérieur
 Lock with top locking point

❸ Mehrfachverriegelungs-Schloss
 Serrure à verrouillage multiple
 Multipoint lock

Zweiflügelige Türen,
 auswärts öffnend,
 Flügelhöhe ≤ 2200 mm

Porte à deux vantaux,
 ouvrant vers l'extérieur,
 hauteur du vantail ≤ 2200 mm

Double leaf door,
 outward opening,
 leaf height ≤ 2200 mm

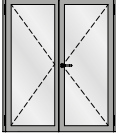
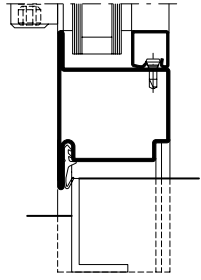
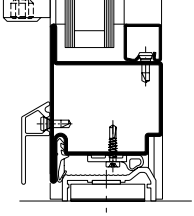
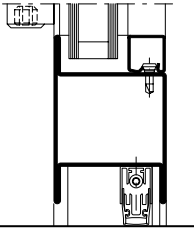
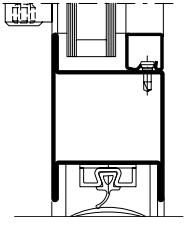
Variante	Beschlag Ferrure Fitting	 EN 12207	 EN 12208	 EN 12210	
					
Anschlagdichtung Joint de butée Rebate gasket		1	2	1A	C2
		2	2	2A	C2
		3	2	2A	C3
Doppel-Anschlagdichtung Joint de base double Double rebate gasket		1	2	2A	C2
		2	2	2A	C2
		3	3	3A	C3
Senkdichtung Joint seuil Drop seal		1	2	1A	C2
		2	2	2A	C2
		3	2	2A	C3
Auflaufdichtung Joint de contact Ramp seal		1	2	0	C2
		2	2	0	C2
		3	2	0	C3

1 Fallenriegel-Schloss
 Serrure à mortaiser
 Latch and bolt lock





2 Schloss mit Obenverriegelung
 Serrure avec verrouillage supérieur
 Lock with top locking point

3 Mehrfachverriegelungs-Schloss
 Serrure à verrouillage multiple
 Multipoint lock

Zweiflügelige Türen,
 einwärts öffnend,
 Flügelhöhe ≤ 2200 mm

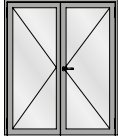
Porte à deux vantaux,
 ouvrant vers l'intérieur,
 hauteur du vantail ≤ 2200 mm

Double leaf door,
 inward opening,
 leaf height ≤ 2200 mm

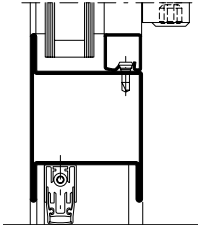
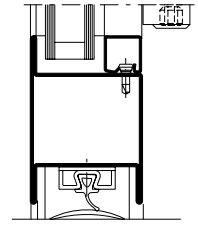
Variante		Beschlag Ferrure Fitting	 EN 12207	 EN 12208	 EN 12210
Senkdichtung Joint seuil Drop seal		❶	2	0	C2
		❷	2	0	C2
		❸	2	0	C3
Auflaufdichtung Joint de contact Ramp seal		❶	2	0	C2
		❷	2	0	C2
		❸	2	0	C3

❶ Fallenriegel-Schloss
 Serrure à mortaiser
 Latch and bolt lock



❷ Schloss mit Obenverriegelung
 Serrure avec verrouillage supérieur
 Lock with top locking point

❸ Mehrfachverriegelungs-Schloss
 Serrure à verrouillage multiple
 Multipoint lock

Zweiflügelige Türen,
 auswärts öffnend,
 Flügelhöhe ≤ 3000 mm

Porte à deux vantaux,
 ouvrant vers l'extérieur,
 hauteur du vantail ≤ 3000 mm

Double leaf door,
 outward opening,
 leaf height ≤ 3000 mm

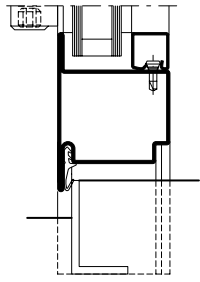
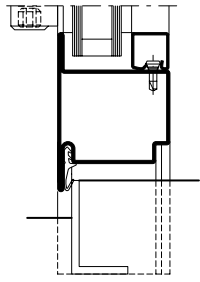
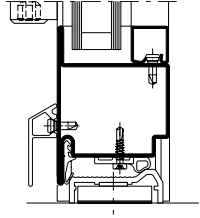
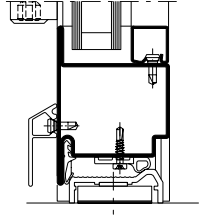
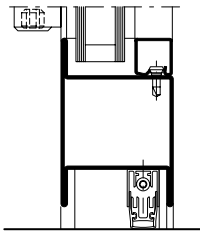
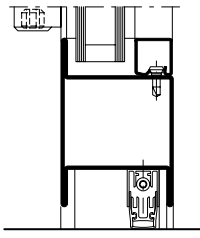
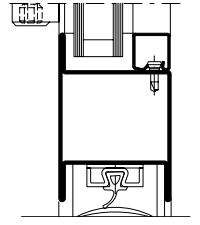
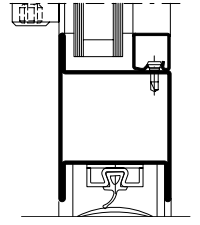
Variante	Beschlag Ferrure Fitting	 EN 12207	 EN 12208	 EN 12210		
Anschlagdichtung Joint de butée Rebate gasket 	Beschlag Ferrure Fitting 	1	0	0	C1	
		2	0	0	0	C1
		3	1	0	0	C2
Doppel-Anschlagdichtung Joint de base double Double rebate gasket 	Beschlag Ferrure Fitting 	1	1	0	C1	
		2	1	0	0	C1
		3	2	0	0	C2
Senkdichtung Joint seuil Drop seal 	Beschlag Ferrure Fitting 	1	0	0	C1	
		2	0	0	0	C1
		3	1	0	0	C2
Aufaufdichtung Joint de contact Ramp seal 	Beschlag Ferrure Fitting 	1	0	0	C1	
		2	0	0	0	C1
		3	1	0	0	C2

1 Fallenriegel-Schloss
 Serrure à mortaiser
 Latch and bolt lock





2 Schloss mit Obenverriegelung
 Serrure avec verrouillage supérieur
 Lock with top locking point

3 Mehrfachverriegelungs-Schloss
 Serrure à verrouillage multiple
 Multipoint lock

Zweiflügelige Türen,
 einwärts öffnend,
 Flügelhöhe ≤ 3000 mm

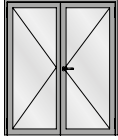
Porte à deux vantaux,
 ouvrant vers l'intérieur,
 hauteur du vantail ≤ 3000 mm

Double leaf door,
 inward opening,
 leaf height ≤ 3000 mm

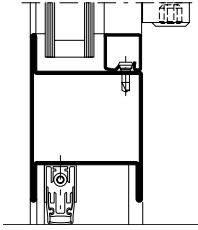
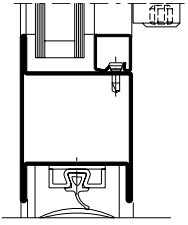
Variante		Beschlag Ferrure Fitting	 EN 12207	 EN 12208	 EN 12210
Senkdichtung Joint seuil Drop seal		1	0	0	C1
		2	0	0	C1
		3	1	0	C2
Auflaufdichtung Joint de contact Ramp seal		1	0	0	C1
		2	0	0	C1
		3	1	0	C2

U_f-Werte
(nach EN ISO 10077-2:2018-01)

Valeurs U_f
(selon EN ISO 10077-2:2018-01)

U_f values
(according to
EN ISO 10077-2:2018-01)

Auf den folgenden Seiten
finden Sie die U_f-Werte für die
verschiedenen Anwendungen von
Jansen-Economy 60.

Vous trouverez les valeurs U_f
pour les différentes applications
Jansen-Economy 60 dans les
pages qui suivent.

On the following pages you
will find the U_f values for the
various applications for
Jansen-Economy 60.

Sie basieren auf folgenden
Grundlagen:

Elles se basent sur les principes
suivants:

They are based on the following:

Stahl

- Profile bandverzinkter Stahl,
unbeschichtet
- Stahl-Glasleisten
- Trockenverglasung
- Nassverglasung

Acier

- Profilés en bande d'acier zingué,
sans revêtement
- Parcloses en acier
- Vitrage à sec
- Vitrage à mastic



Steel

- Strip galvanised steel profiles,
uncoated
- Steel glazing beads
- Glazing with dry glazing
- Glazing with sealing

U_f-Werte
 (nach EN ISO 10077-2:2018-01)

Valeurs U_f
 (selon EN ISO 10077-2:2018-01)

U_f values
 (according to EN ISO 10077-2:2018-01)

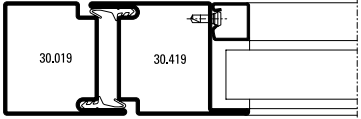
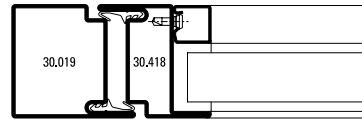
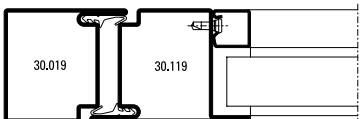
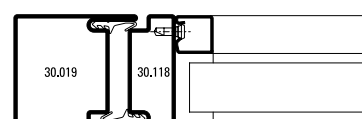
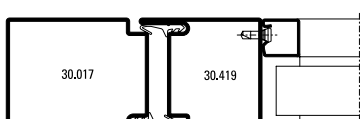
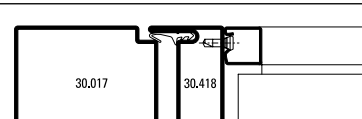
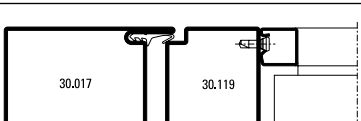
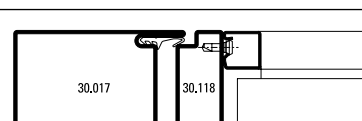
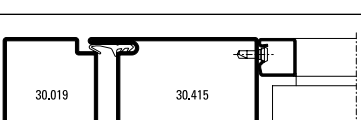
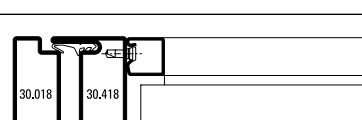
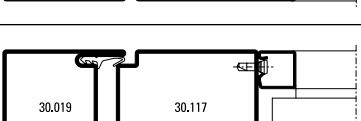
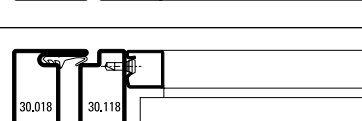
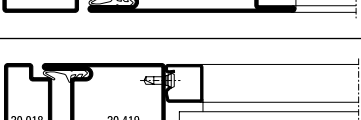
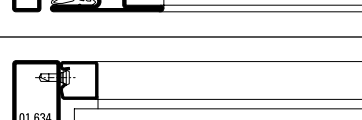
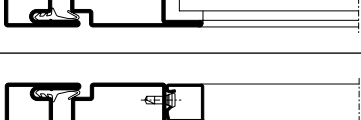
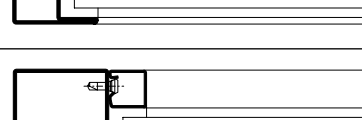
 Füllelementstärken Elements de remplissages Infill elements ≥ 24 mm		 Füllelementstärken Elements de remplissages Infill elements ≥ 24 mm	
 30.019 30.419	5,5 W/m ² K	 30.019 30.418	5,7 W/m ² K
 30.019 30.119	5,6 W/m ² K	 30.019 30.118	5,8 W/m ² K
 30.017 30.419	5,3 W/m ² K	 30.017 30.418	5,5 W/m ² K
 30.017 30.119	5,3 W/m ² K	 30.017 30.118	5,5 W/m ² K
 30.019 30.415	5,3 W/m ² K	 30.018 30.418	6,0 W/m ² K
 30.019 30.117	5,3 W/m ² K	 30.018 30.118	6,1 W/m ² K
 30.018 30.419	5,6 W/m ² K	 01.634	6,9 W/m ² K
 30.018 30.119	5,7 W/m ² K	 01.684	6,1 W/m ² K

U_f-Werte
 (nach EN ISO 10077-2:2018-01)

Valeurs U_f
 (selon EN ISO 10077-2:2018-01)

U_f values
 (according to EN ISO 10077-2:2018-01)

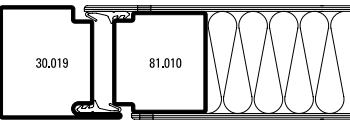
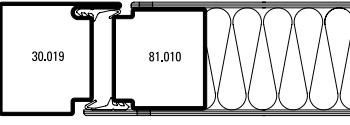
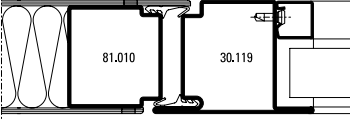
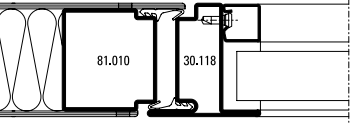
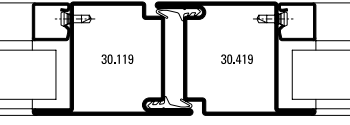
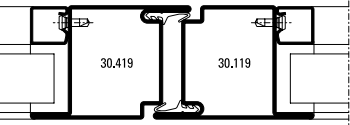
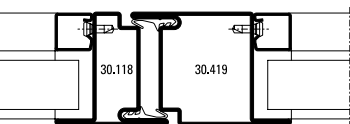
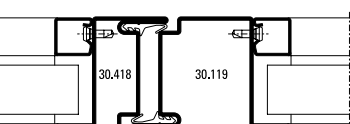

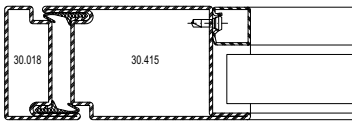
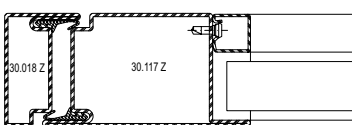
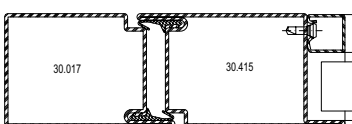
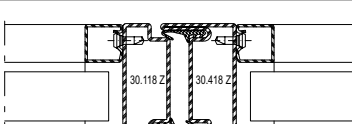
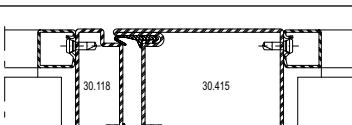
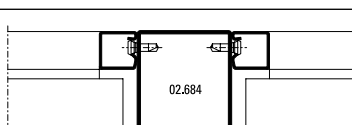
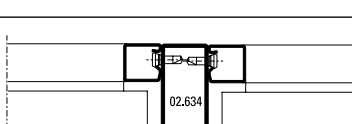
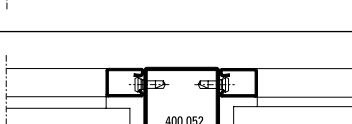
	Füllelementstärken Elements de remplissages Infill elements ≥ 24 mm
	5,3 W/m²K
	5,3 W/m²K
	5,7 W/m²K
	6,0 W/m²K
	5,8 W/m²K
	5,8 W/m²K
	6,1 W/m²K
	6,1 W/m²K

	Füllelementstärken Elements de remplissages Infill elements ≥ 24 mm
	5,3 W/m²K
	5,4 W/m²K
	5,1 W/m²K
	6,5 W/m²K
	5,7 W/m²K
	6,3 W/m²K
	7,2 W/m²K
	6,4 W/m²K



U_f-Werte
 (nach EN ISO 10077-2:2018-01)

Valeurs U_f
 (selon EN ISO 10077-2:2018-01)

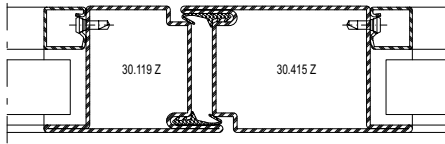
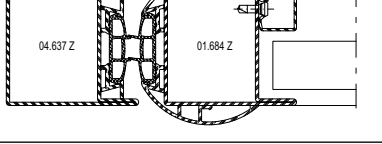
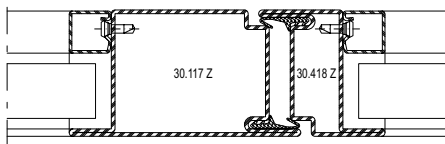
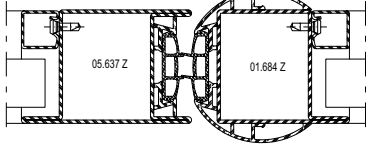
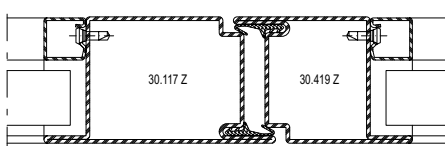
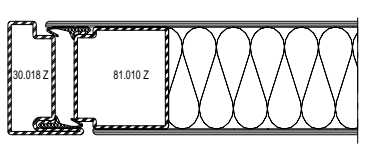
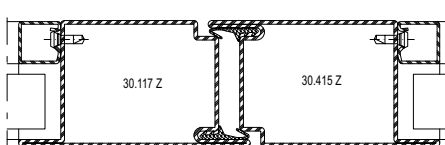
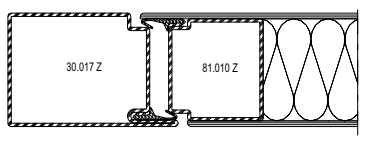
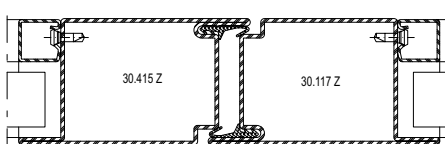
U_f values
 (according to EN ISO 10077-2:2018-01)

	Füllelementstärken Elements de remplissages Infill elements ≥ 24 mm		Füllelementstärken Elements de remplissages Infill elements ≥ 24 mm
	5,5 W/m²K		5,8 W/m²K
	5,7 W/m²K		6,0 W/m²K
	5,5 W/m²K		5,4 W/m²K
	5,3 W/m²K		5,1 W/m²K
	5,3 W/m²K		

U_f-Werte
 (nach EN ISO 10077-2:2018-01)

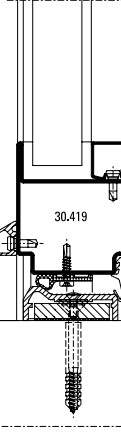
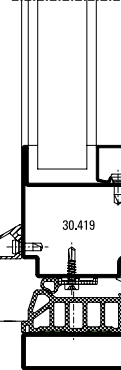
 <p>Füllelementstärken Elements de remplissages Infill elements</p> <p>≥ 24 mm</p>	
 <p>01.684</p>	<p>6,1 W/m²K</p>
 <p>30.419</p>	<p>6,3 W/m²K</p>
 <p>30.419</p>	<p>5,6 W/m²K</p>

Valeurs U_f
 (selon EN ISO 10077-2:2018-01)

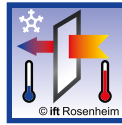
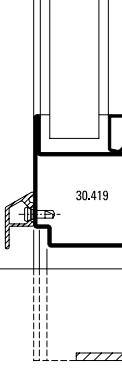
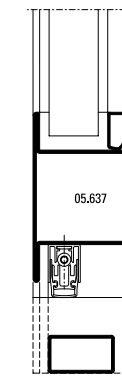
 <p>Füllelementstärken Elements de remplissages Infill elements</p> <p>≥ 24 mm</p>	
 <p>30.419</p>	<p>6,3 W/m²K</p>
 <p>05.637</p>	<p>5,6 W/m²K</p>

U_f values
 (according to EN ISO 10077-2:2018-01)

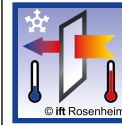
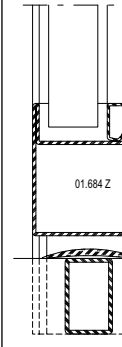
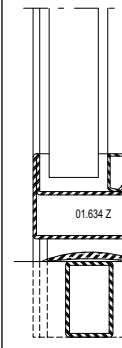
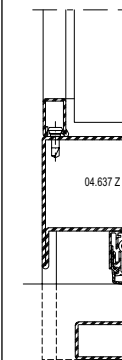
 <p>Füllelementstärken Elements de remplissages Infill elements</p> <p>≥ 24 mm</p>	
 <p>01.684 Z</p>	<p>6,1 W/m²K</p>
 <p>01.634 Z</p>	<p>6,8 W/m²K</p>
 <p>04.637 Z</p>	<p>5,5 W/m²K</p>

U_f-Werte
 (nach EN ISO 10077-2:2018-01)

Valeurs U_f
 (selon EN ISO 10077-2:2018-01)

U_f values
 (according to EN ISO 10077-2:2018-01)

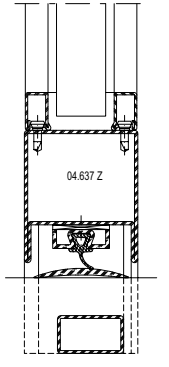
 Füllelementstärken Elements de remplissages Infill elements ≥ 24 mm	
	5,6 W/m ² K

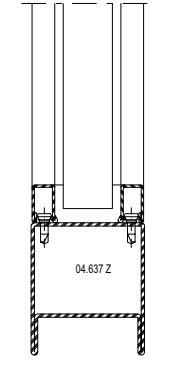
 Füllelementstärken Elements de remplissages Infill elements ≥ 24 mm	
	5,6 W/m ² K

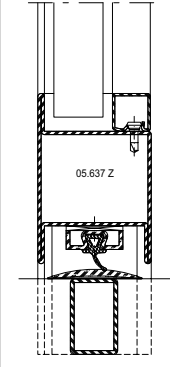
 Füllelementstärken Elements de remplissages Infill elements ≥ 24 mm	
	5,7 W/m ² K

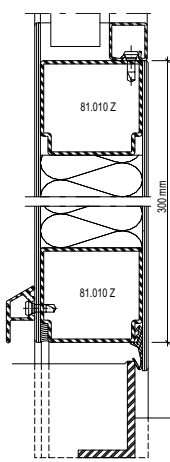
	4,4 W/m ² K
--	------------------------

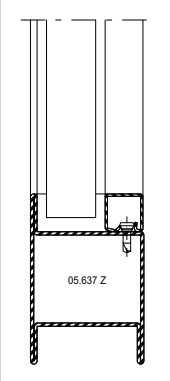
	5,7 W/m ² K
--	------------------------

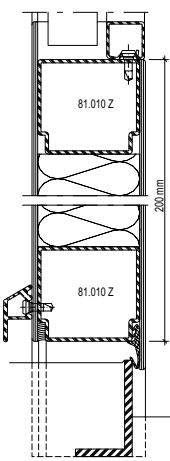
	5,2 W/m ² K
---	------------------------



Schallschutz

Ausführungsvarianten

Die nachfolgende Typenübersicht ergibt einen Überblick über die beurteilten Varianten.

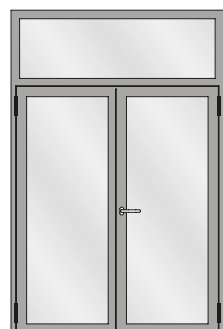
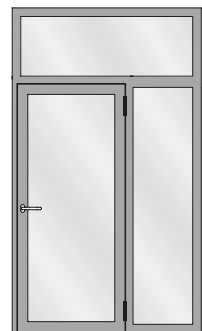
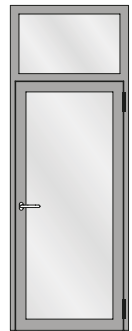
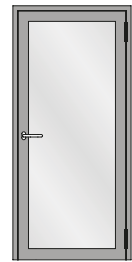

Isolation phonique

Modèles

L'aperçu des types suivant fournit une vue d'ensemble des variantes examinées.

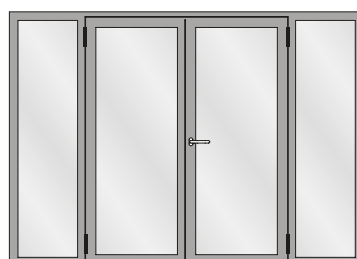
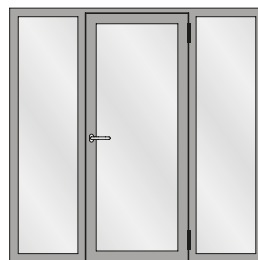
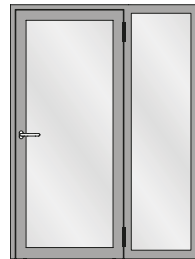
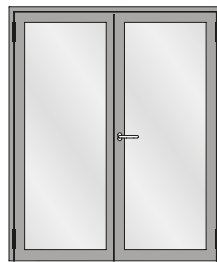

Sound insulation

Design range

The following overview of types provides an overview of the evaluated designs.

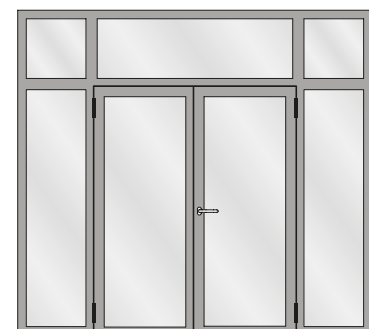
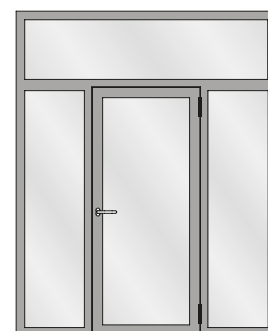

Schallschutz

Isolation phonique

Sound insulation

Tabelle A1

Korrekturtabelle für Jansen-Economy-Türen mit Glasfüllungen

Tableau A1

Tableau de correction pour les portes Jansen-Economy avec vitrage

Table A1

Correction table for Jansen-Economy doors with glass

	1	2	3	4	5	6	7	8	9	10	11
	Türe mit zwei absenkba- ren Bodendichtungen Porte avec deux joint seuil automatique Door with two threshold gaskets that can be lowered	Glas Verre Glass	Korrekturen Corrections Corrections								
	$R_{w(C, Ctr)}$ dB	$R_{w, P, Glas}$ dB	K_S dB	K_{FV} dB	K_{Nass} dB	K_{1aB} dB	$K_{W/S}$ dB	$K_{G 0,4}$ dB	$K_{G 1,8}$ dB	$K_{G 2,6}$ dB	$K_{G 3,2}$ dB
1	32 (-1; -5)	31	0	-1	0	0	0	0	-1	-2	-3
2	33 (-1; -5)	32	0	-1	0	0	0	0	-1	-2	-3
3	35 (-1; -5)	34	0	-1	0	0	0	0	-1	-2	-3
4	36 (-2; -5)	35	0	-1	-1	0	0	0	-1	-2	-3
5	37 (-2; -5)	37	0	0	-1	0	-1	0	-1	-2	-3
6	38 (-2; -5)	39	0	0	-1	-1	-1	0	-1	-2	-3
7	39 (-2; -5)	40	0	0	-1	-1	-1	0	-1	-2	-3
8	40 (-2; -5)	41	0	0	-1	-1	-2	-1	-1	-2	-3
9	41 (-2; -5)	42	0	0	-1	-1	-2	-2	-1	-2	-3
10	42 (-2; -5)	43	-1	0	-1	-1	-2	-2	-1	-2	-3
11	42 (-2; -5)	44	-1	0	-1	-1	-2	-2	-1	-2	-3
12	43 (-2; -5)	45	-1	+1	-1	-1	-3	-3	-1	-2	-3
13	44 (-2; -5)	49	-1	+1	-1	-2	-3	-3	-1	-2	-3

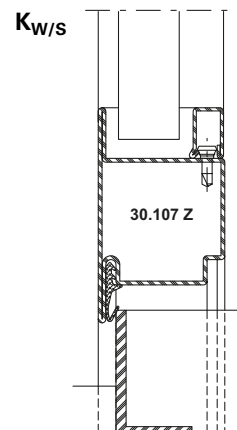
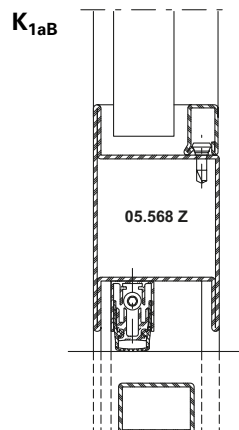
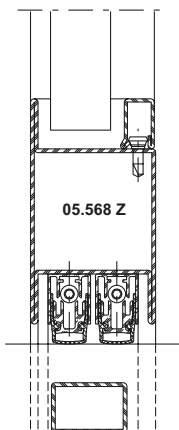

Schallschutz

Der aus der Tabelle A1 abzulesende Wert für die Schalldämmung $R_{w, Tür}$ beträgt:

Isolation phonique

La valeur à relever sur le tableau A1 concernant l'isolement contre les sons aériens $R_{w, Porte}$ est la suivante:

Sound insulation

The value taken from table A1 for the sound insulation $R_{w, Door}$ is:

$$R_{w, Tür} = R_w + K_S + K_{FV} + K_{Nass} + K_{1aB} + K_{W/S} + K_{Band} + K_{G 0,4} + K_{G 1,8} + K_{G 2,6} + K_{G 3,2} \text{ dB}$$

- R_w** bewertetes Schalldämm-Mass der Türe in Abhängigkeit von der Schalldämmung $R_{w,P, Glas}$
- $R_{w,P, Glas}$** bewertetes Schalldämm-Mass der Verglasung (Prüfwert nach ISO 140-3, mit Prüfnachweis einer PÜZ-Stelle). Alternativ können Tabellenwerte nach DIN EN 12758, Abschnitt 6 verwendet werden
- K_S** Korrekturwert für zweiflügelige Türen
- K_{FV}** Korrekturwert für Festverglasungen mit erhöhtem Scheibenanteil
- K_{Nass}** Korrekturwert für Nassverglasung
- K_{1aB}** Korrekturwert für Türen mit einer absenkbaren Bodendichtung
- K_{Band}** Korrekturwert bei Verwendung von Anschlagbändern, die eine Dichtungsebene unterbrechen ($K_{Band} = - 0,5 \text{ dB pro Band}$)
- $K_{W/S}$** Korrekturwert für Türen mit einer Anschlagsschwelle
- $K_{G 0,4}$** Korrekturwert für Einzelscheiben mit einer Glasfläche $\leq 0,4 \text{ m}^2$. Die Korrektur gilt auch für Konstruktionen mit glasteilenden Sprossen.
- $K_{G 1,8}$** Korrekturwert für Einzelscheiben mit einer Glasfläche $\geq 1,8 \text{ m}^2$
- $K_{G 2,6}$** Korrekturwert für Einzelscheiben mit einer Glasfläche $\geq 2,6 \text{ m}^2$
- $K_{G 3,2}$** Korrekturwert für Einzelscheiben mit einer Glasfläche $\geq 3,2 \text{ m}^2$

- R_w** Mesure d'isolement contre les sons aériens des portes évaluée suivant l'isolement phonique $R_{w,P, Glas}$
- $R_{w,P, Glas}$** Cote d'isolement acoustique du vitrage évalué (valeur contrôlée selon ISO 140-3 avec certificat d'un bureau de contrôle, de surveillance ou de certification). Il est également possible d'utiliser les valeurs selon le tableau DIN EN 12758, section 6
- K_S** Valeur de correction pour portes à deux vantaux
- K_{FV}** Valeur de correction pour vitrages fixes à fort pourcentage de vitre
- K_{Nass}** Valeur de correction pour vitrage avec mastic
- K_{1aB}** Valeur de correction pour portes avec un joint seuil automatique
- K_{Band}** Valeur corrective en cas d'utilisation de paumelles qui interrompent un plan d'étanchéité ($K_{Band} = - 0,5 \text{ dB par paumelle}$)
- $K_{W/S}$** Valeur de correction pour portes avec un seuil de butée
- $K_{G 0,4}$** Valeur de correction pour vitres individuelles avec une surface vitrée $\leq 0,4 \text{ m}^2$. La correction s'applique aussi aux constructions à meneaux séparant les vitres.
- $K_{G 1,8}$** Valeur de correction pour vitres individuelles avec surface vitrée $\geq 1,8 \text{ m}^2$
- $K_{G 2,6}$** Valeur de correction pour vitres individuelles avec surface vitrée $\geq 2,6 \text{ m}^2$
- $K_{G 3,2}$** Valeur de correction pour vitres individuelles avec surface vitrée $\geq 3,2 \text{ m}^2$

- R_w** Airborne sound reduction index of doors depending on the sound insulation $R_{w,P, Glas}$
- $R_{w,P, Glas}$** Airborne sound reduction index (test value in accordance with ISO 140-3, with a test certificate from a recognised testing, inspection or certification body). Alternatively, the tabulated values in DIN EN 12758, Section 6 may be used
- K_S** Correction value for double-leaf doors
- K_{FV}** Correction value for fixed glazing with increased proportion of pane
- K_{Nass}** Correction value for glazing with sealing
- K_{1aB}** Correction value for doors with a threshold gasket that can be lowered
- K_{Band}** Correction value when using hinges that interrupt a sealing plane ($K_{Band} = - 0.5 \text{ dB per hinge}$)
- $K_{W/S}$** Correction value for doors with a rebate threshold
- $K_{G 0,4}$** Correction value for single panes with a glass area $\leq 0,4 \text{ m}^2$. The correction also applies to buildings with glazing bars
- $K_{G 1,8}$** Correction value for single panes with a glass area $\geq 1,8 \text{ m}^2$
- $K_{G 2,6}$** Correction value for single panes with a glass area $\geq 2,6 \text{ m}^2$
- $K_{G 3,2}$** Correction value for single panes with a glass area $\geq 3,2 \text{ m}^2$

METALFORM

MASTERS OF METAL

UNITED KINGDOM

METALFORM

NORWAYMETAL LTD

53 Chelsea Manor Street

London, SW3 5RZ

SALES@METALFORM.UK

+44 20 81298814

GERMANY

METALFORM GMBH

Carl-Zeiss-Ring 15A

85737 Ismaning

SALES@METALFORMGROUP.DE

+49 17663630406

NORWAY

METALFORM AS

Brochmannsveien 2

1950 Rømskog

SALG@METALFORM.NO

+47 401 62 446

METALFORMGROUP

SALES@METALFORMGROUP.COM